

**EASY
SPACE**

**4 Layer
Single Drawer**

Dimension:
374 x 516 x 650 mm

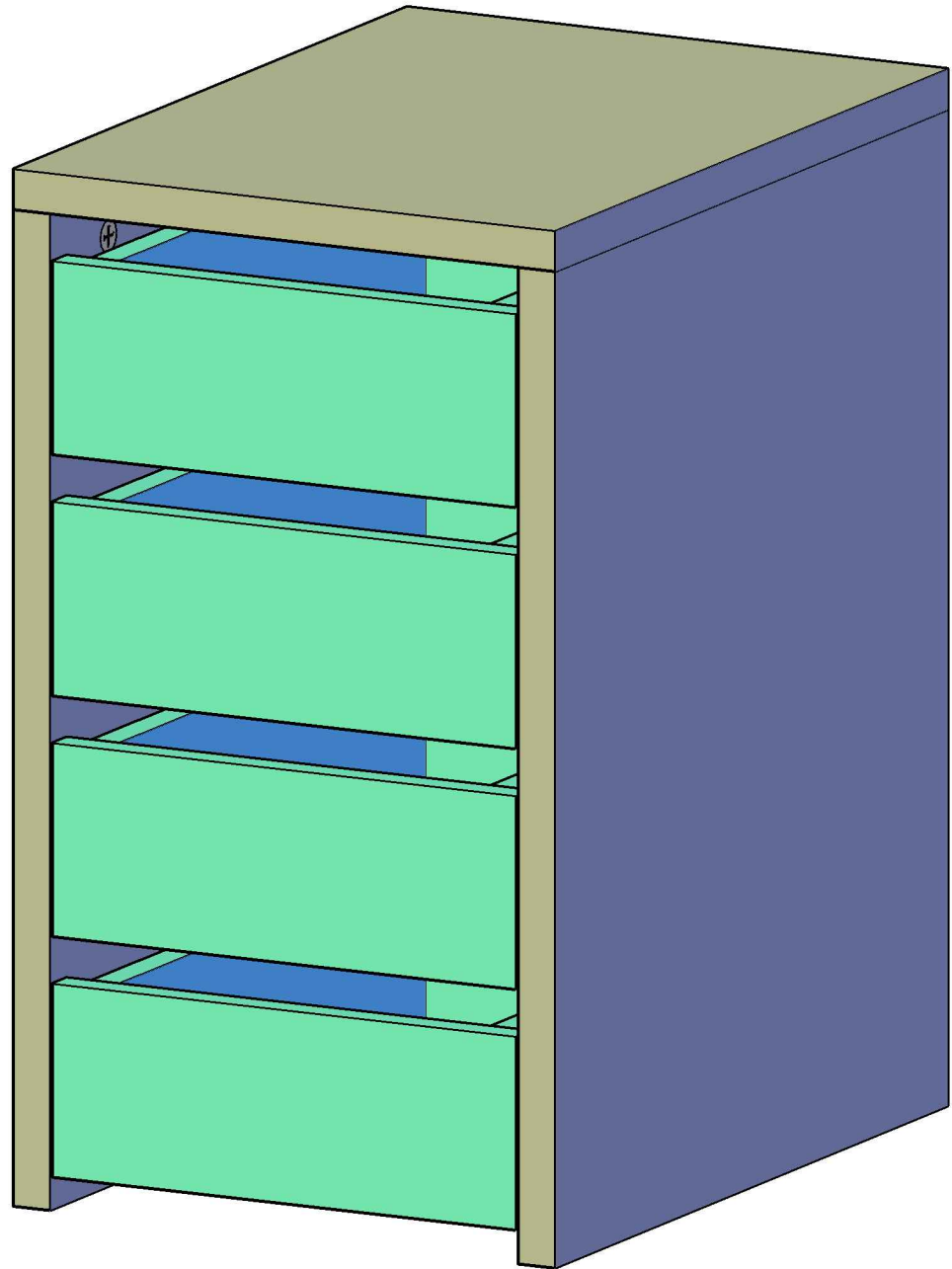

Assembly Guide

Step 1

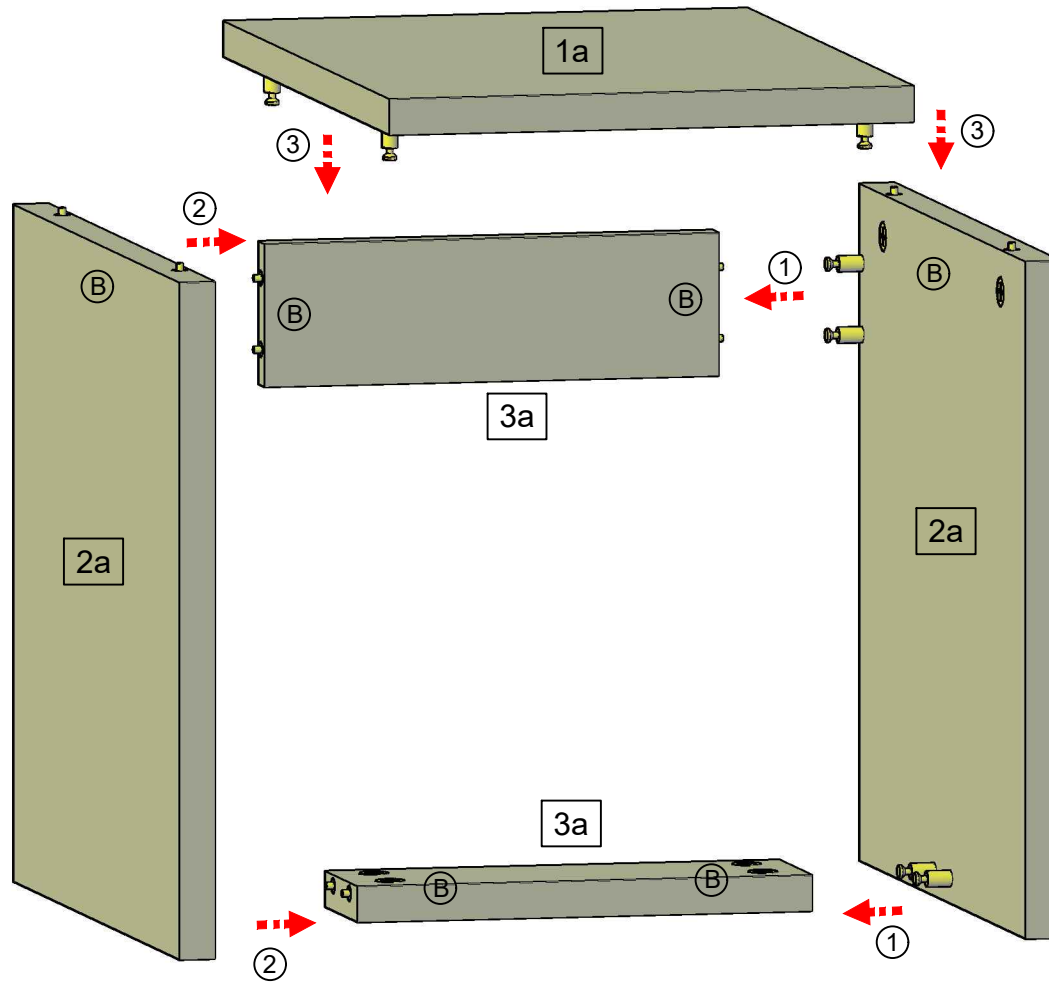

Parts List:

- 1a. Top Panel Board x 1pc.
- 2a. Left & Right Panel Board x 2pcs.
- 3a. Base Panel Board x 2pcs.
- 1b. Drawer Left & Right Panel Board x 8pcs.
- 2b. Drawer Front & Back Panel Board x 8pcs.
- 3b. Drawer Bottom Panel Board x 4pcs.

Assembly Guide

Drawer Assembly Guide

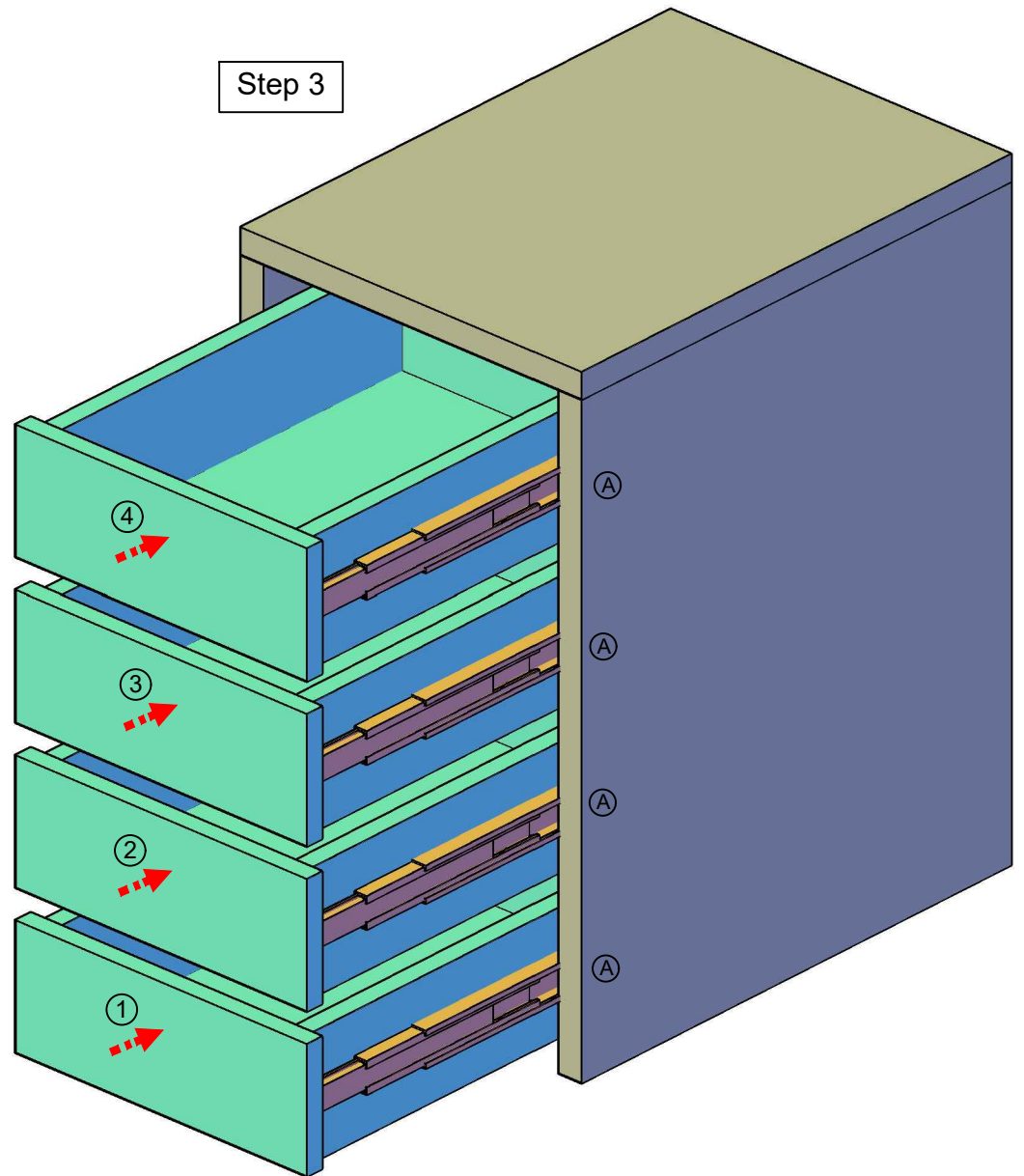
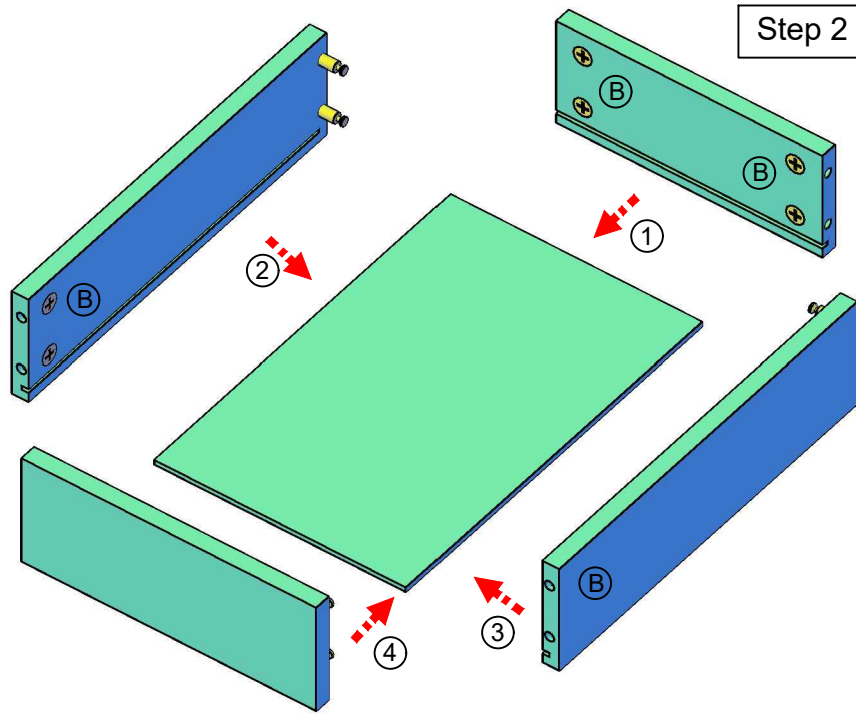

ACCESSORIES:

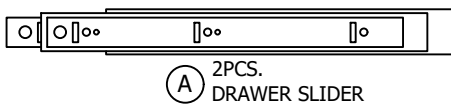
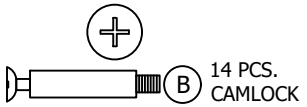

HOW TO USE CAMLOCK & PIN:

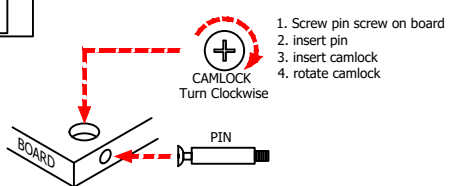

TOOLS:

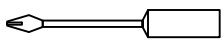

SCREW DRIVER