

**EASY  
SPACE**

**3 Layer  
Double Drawer**

Dimension:  
766 x 516 x 493 mm

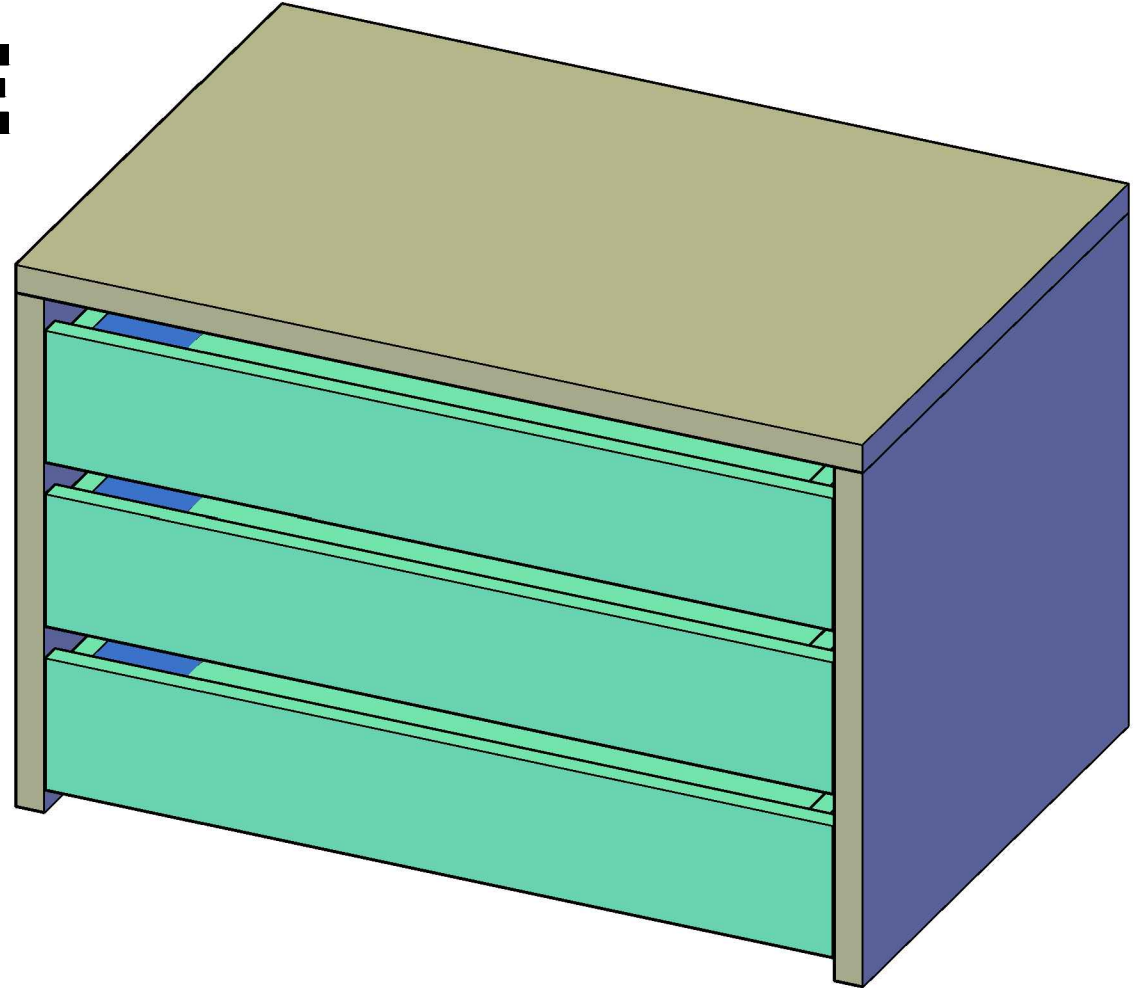

# Assembly Guide

Step 1

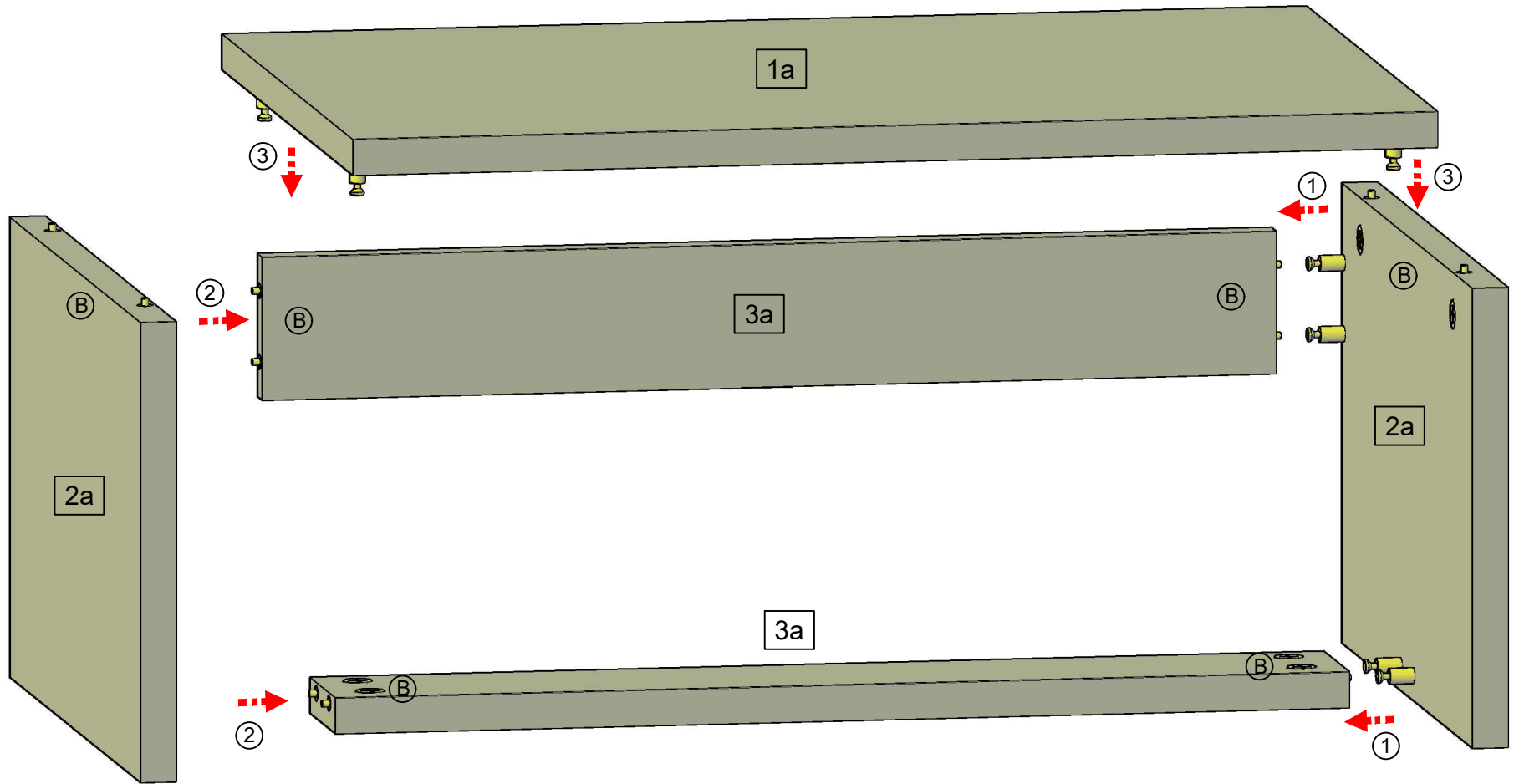

## Parts List:

- 1a. Top Panel Board x 1pc.
- 2a. Left & Right Panel Board x 2pcs.
- 3a. Base Panel Board x 2pcs.
- 1b. Drawer Left & Right Panel Board x 6pcs.
- 2b. Drawer Front & Back Panel Board x 6pcs.
- 3b. Drawer Bottom Panel Board x 3pcs.

# Assembly Guide

## Drawer Assembly Guide

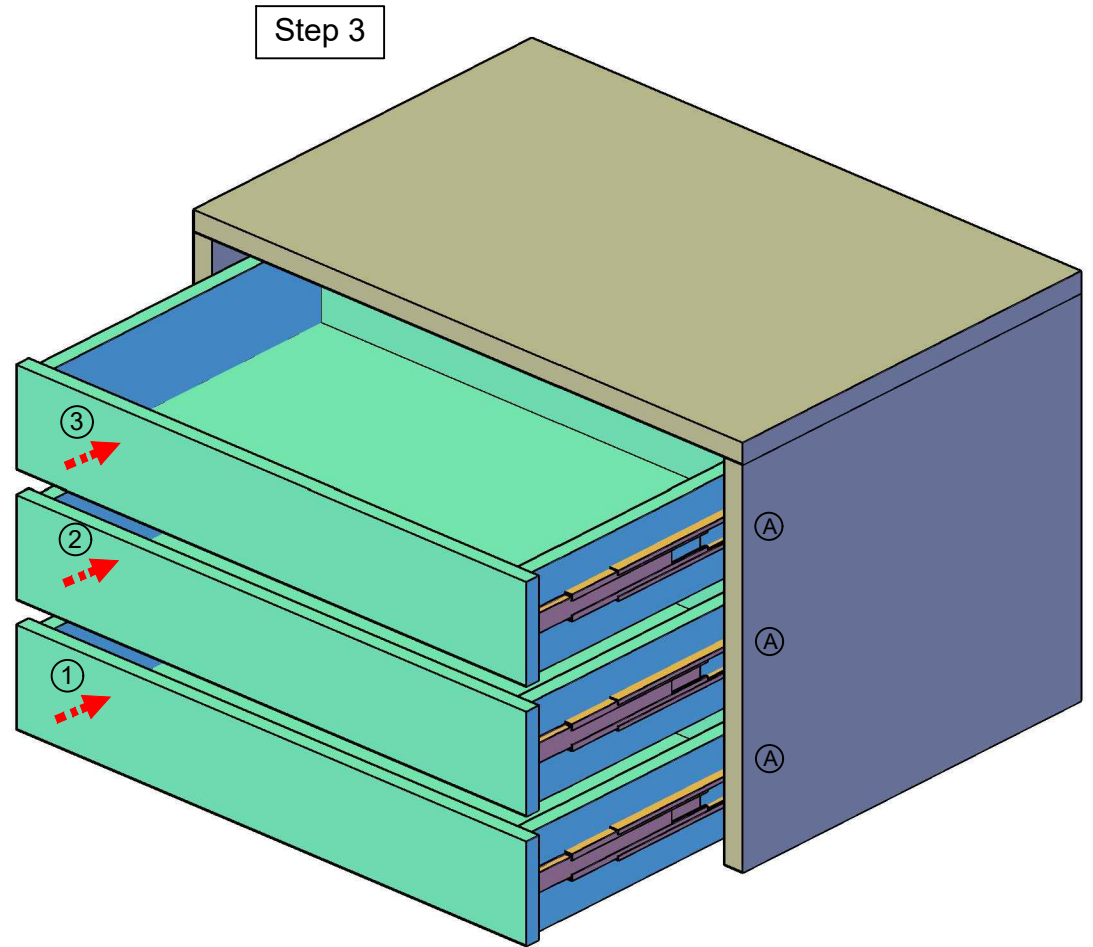
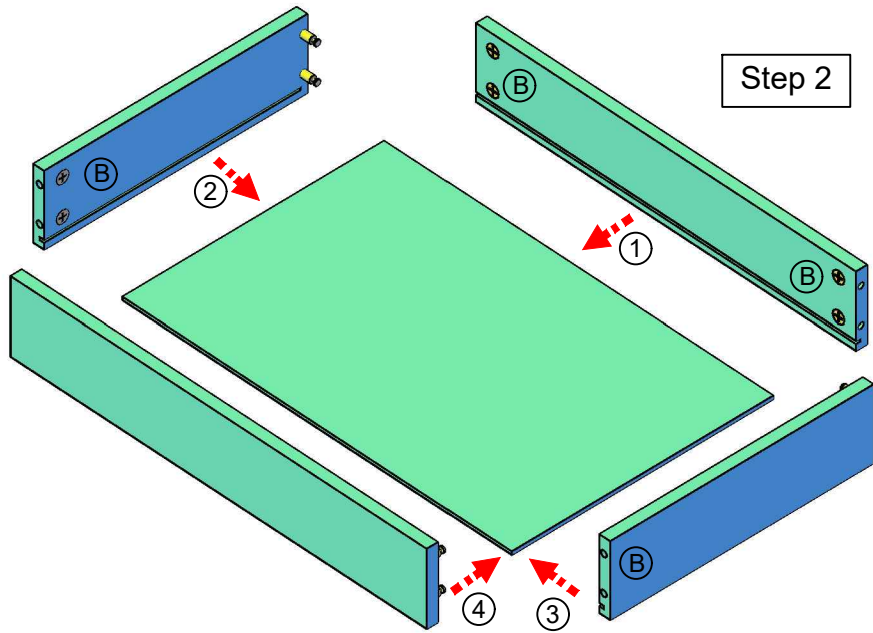

### ACCESSORIES:

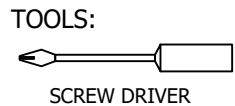
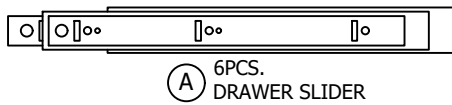
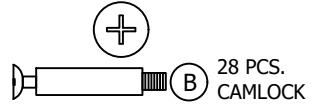

### HOW TO USE CAMLOCK & PIN:

