

- GB** Diesel high pressure kit
- FR** Kit de haute pression diesel
- DE** Diesel-Hochdruck-Kit
- SP** Kit de alta presión de diesel
- IT** Kit alta pressione diesel
- PT** Kit de alta pressão diesel
- NL** Dieselhogedrukset

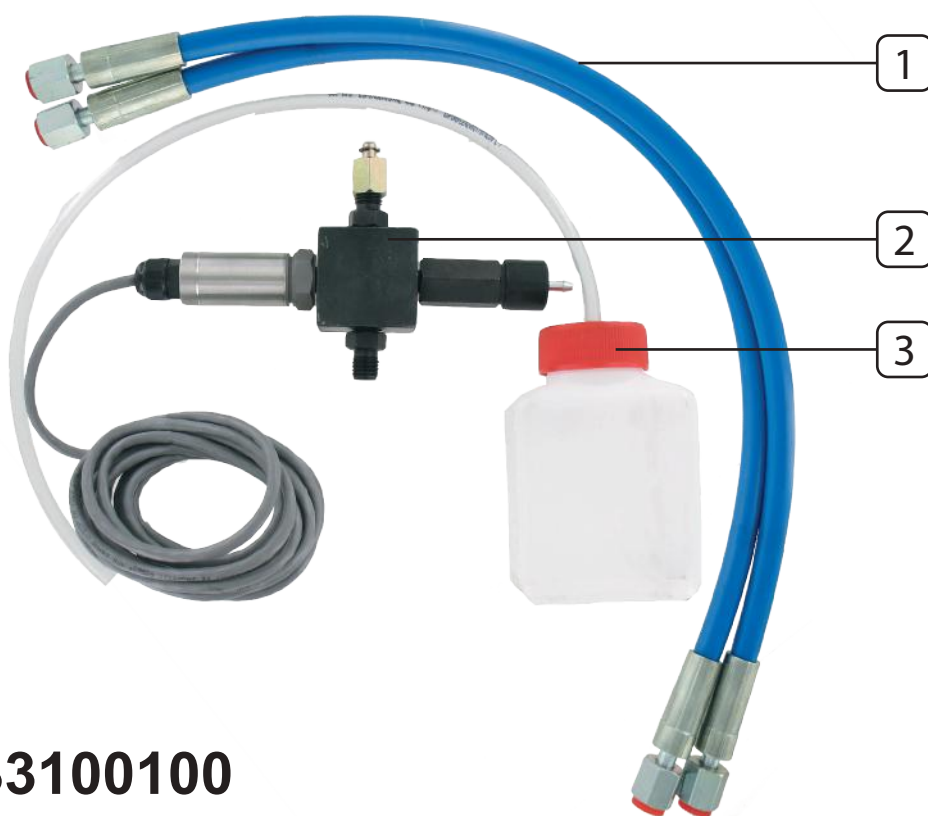

**33100100**



**33100400**



**33100500**

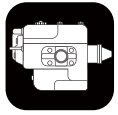

Pump

2



Regulator

2

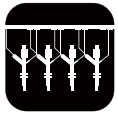

Injector

3



Common rail

5

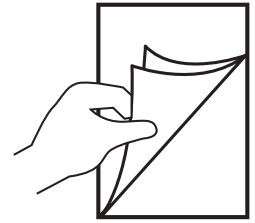

System :

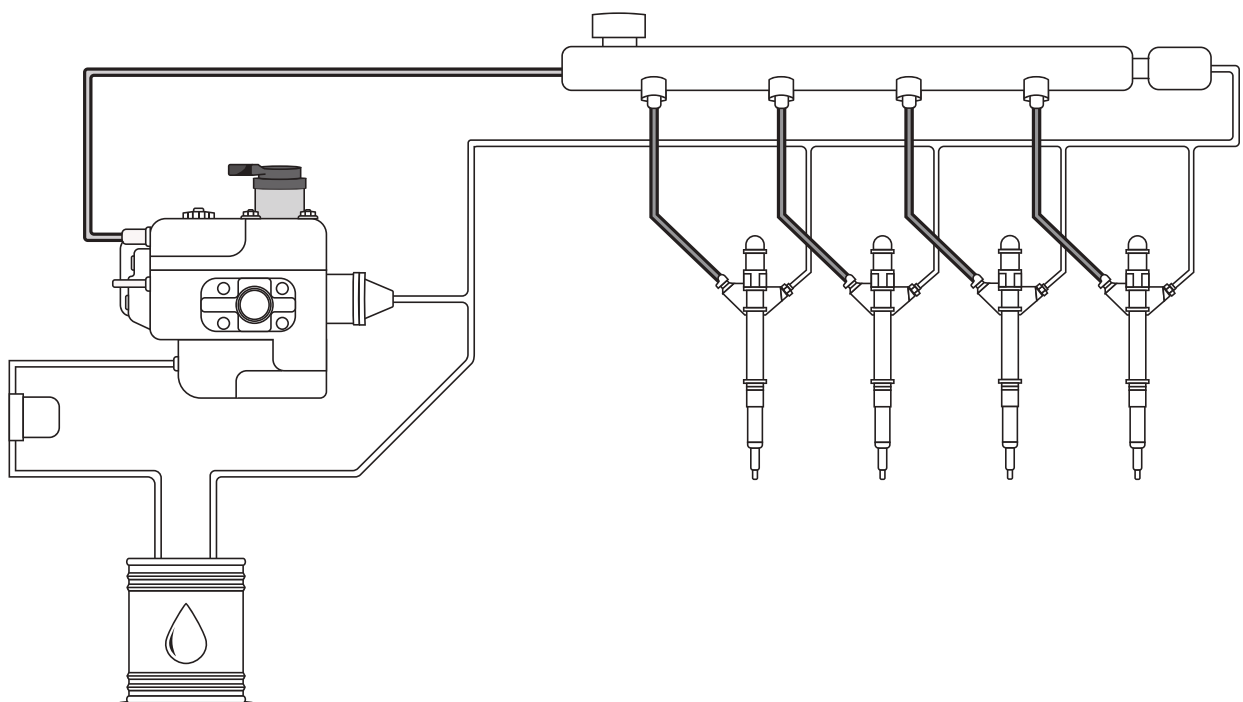



33100100

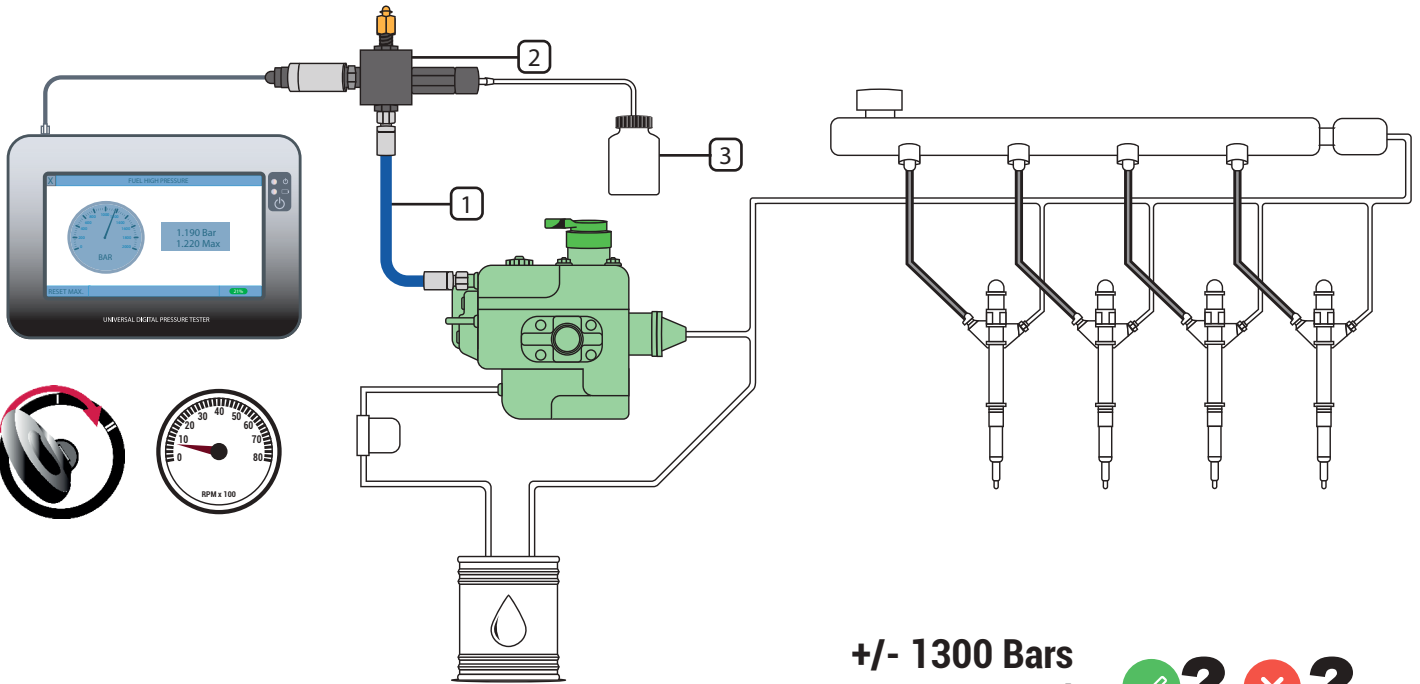

+/- 1300 Bars  
+/- 18000 Psi



33100100 + 33100500

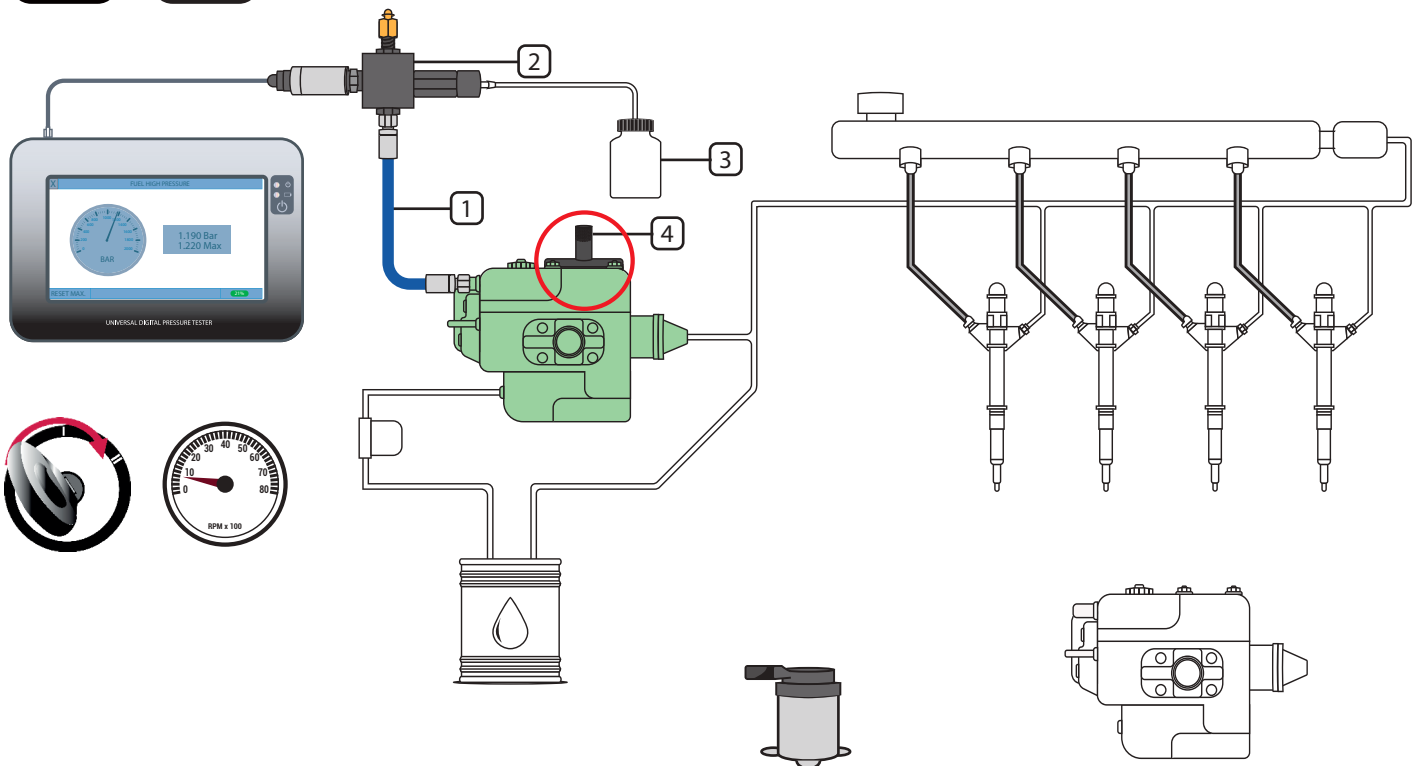

 Tested parts

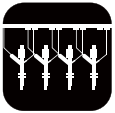

### 33100100 + 33100500

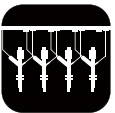
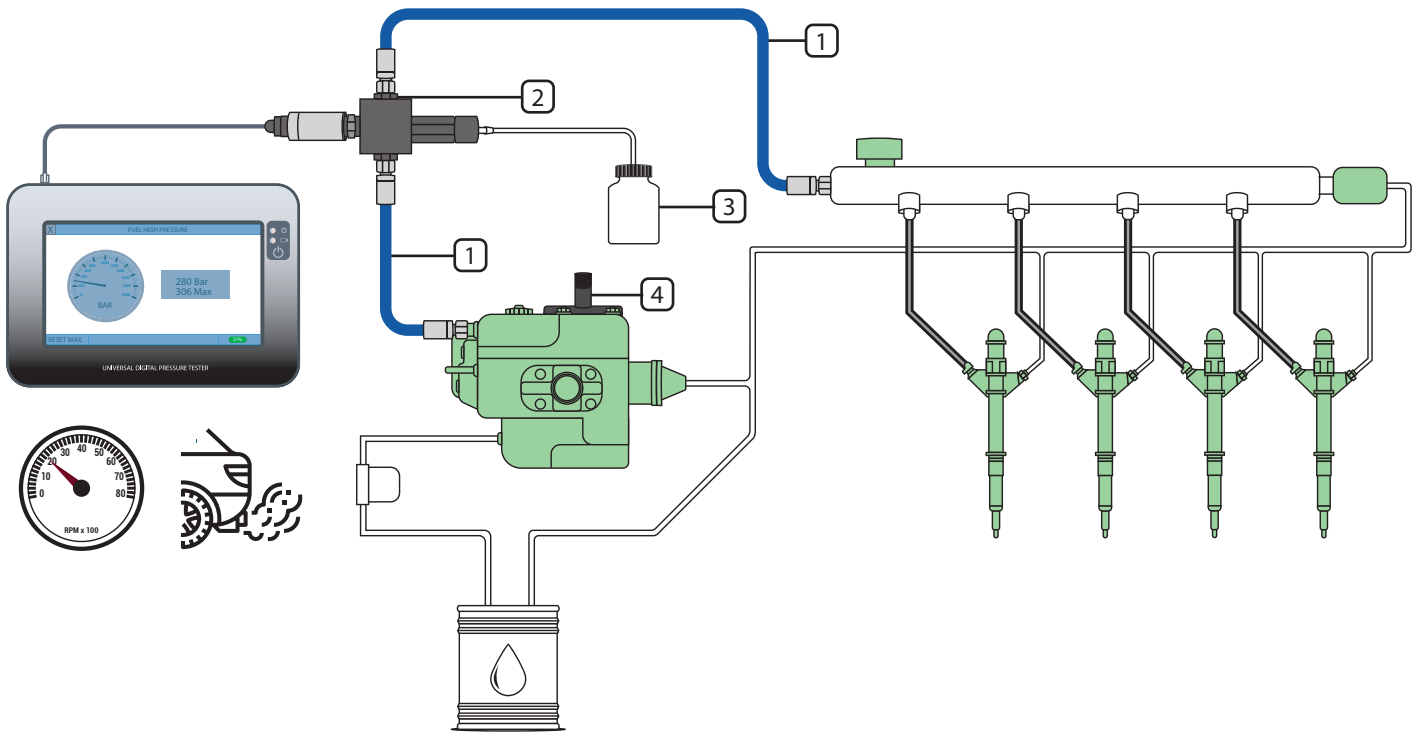

### 33100100 + 33100500 + 33100400

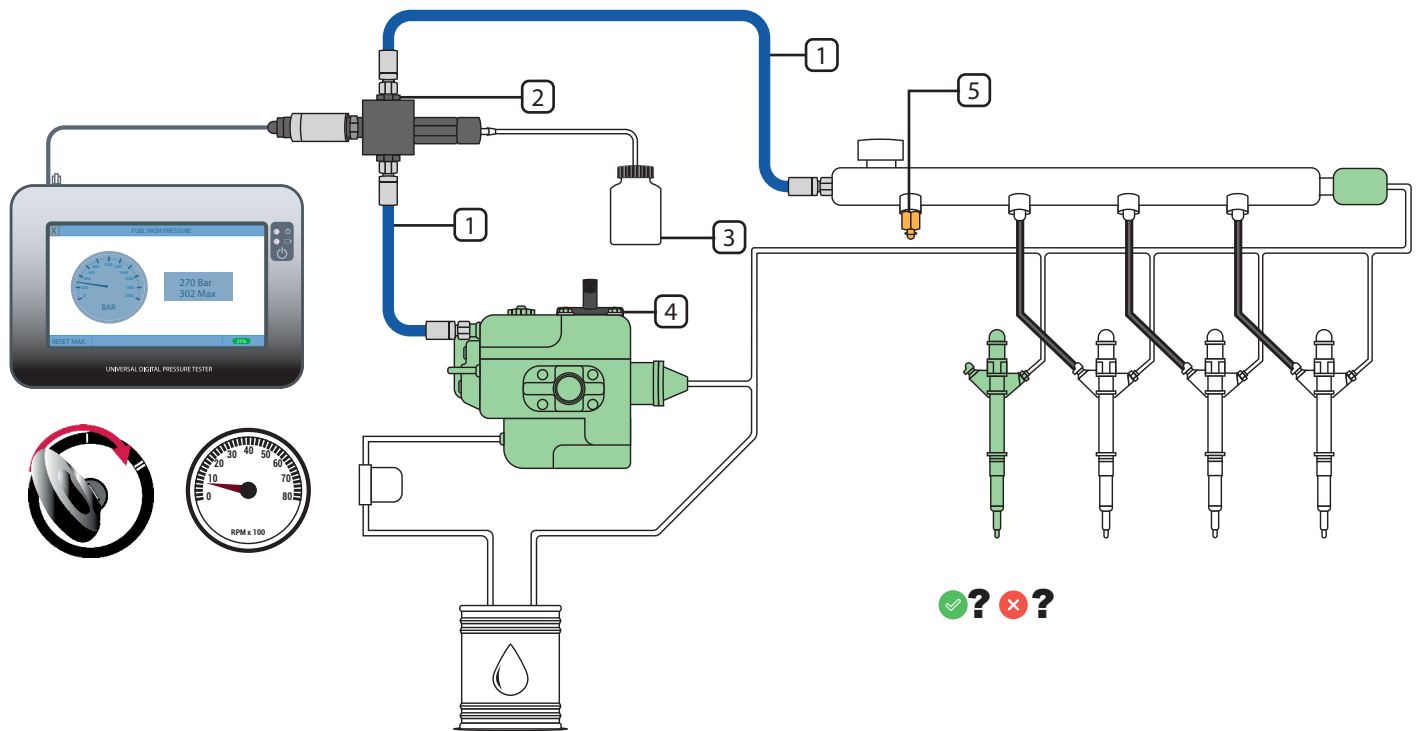

 Tested parts



33100100 + 33100500 + 33100400

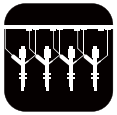
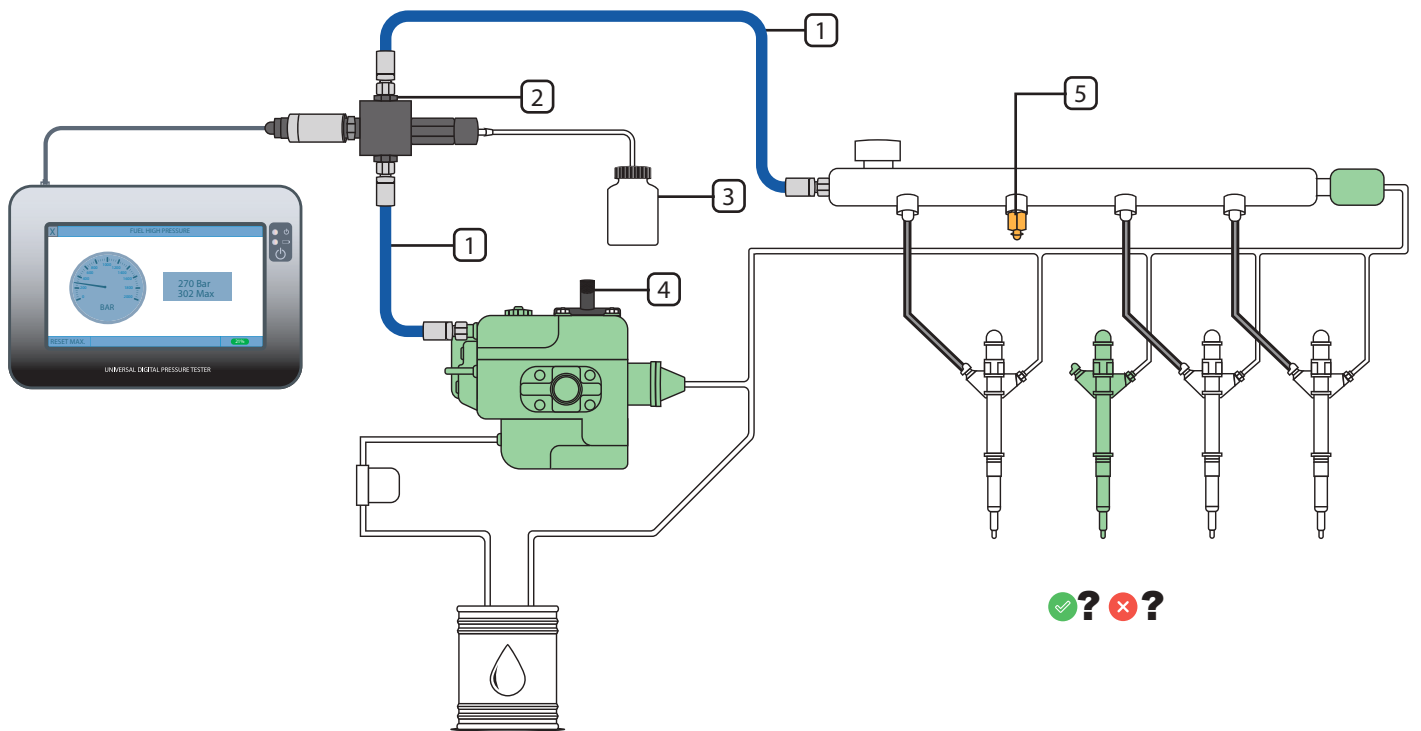

33100100 + 33100500 + 33100400

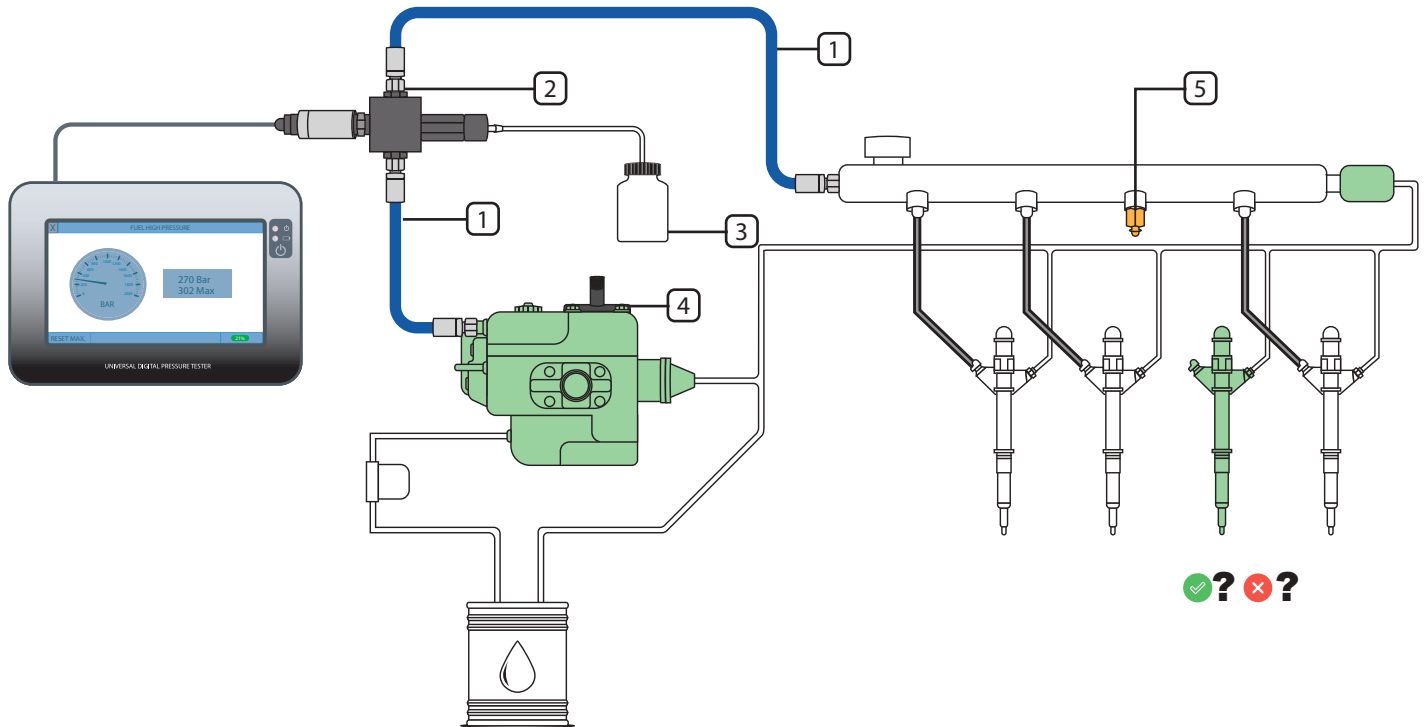

 Tested parts



33100100 + 33100500 + 33100400

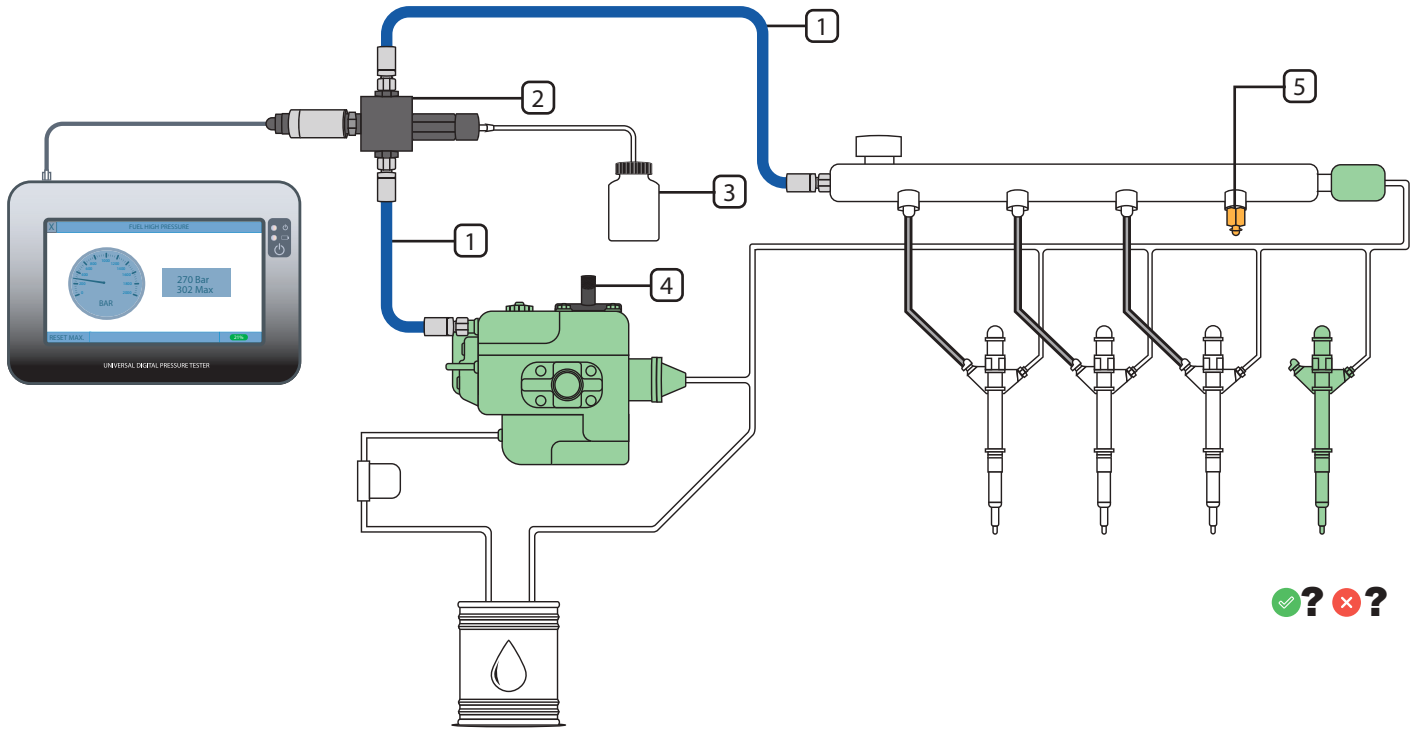

33100100 + 33100500 + 33100400

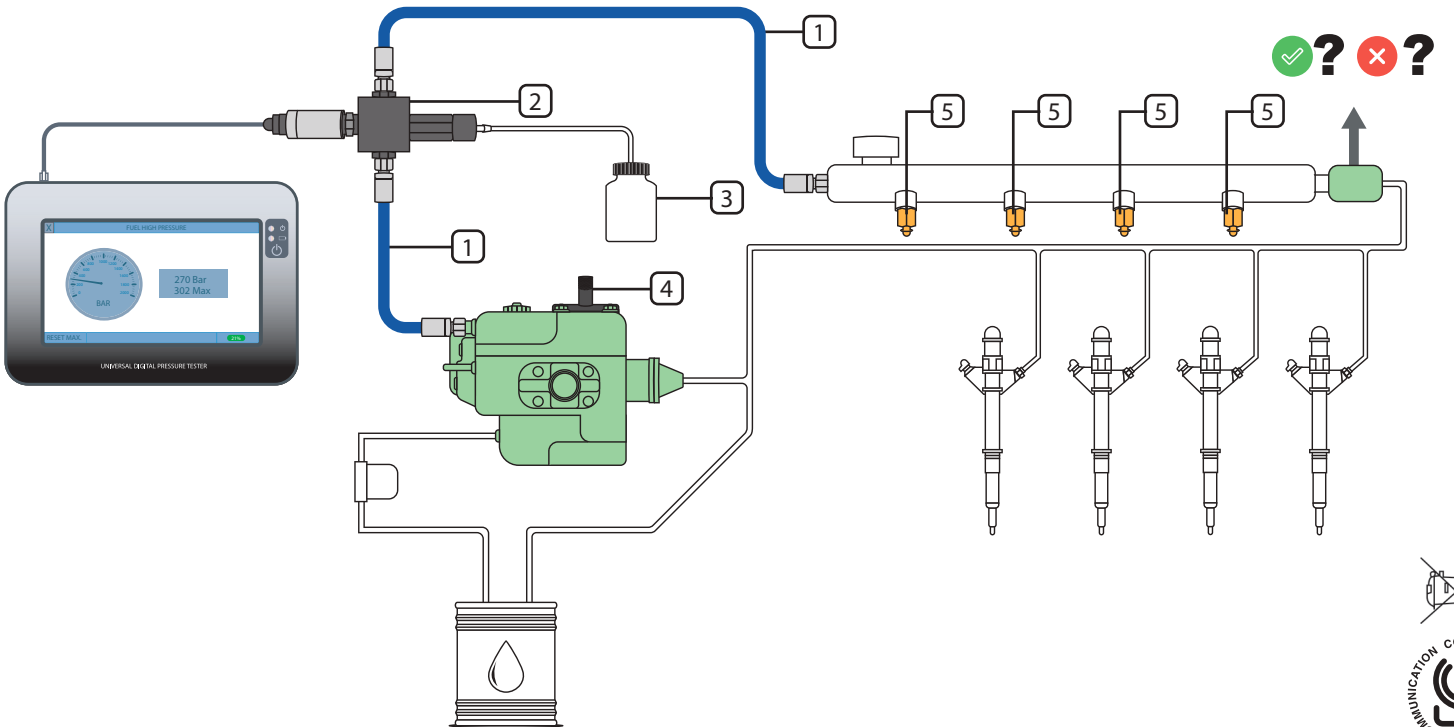

Tested parts

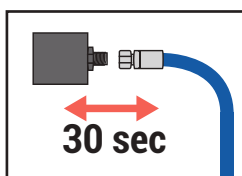

FEDERAL COMMUNICATION COMMISSION

