

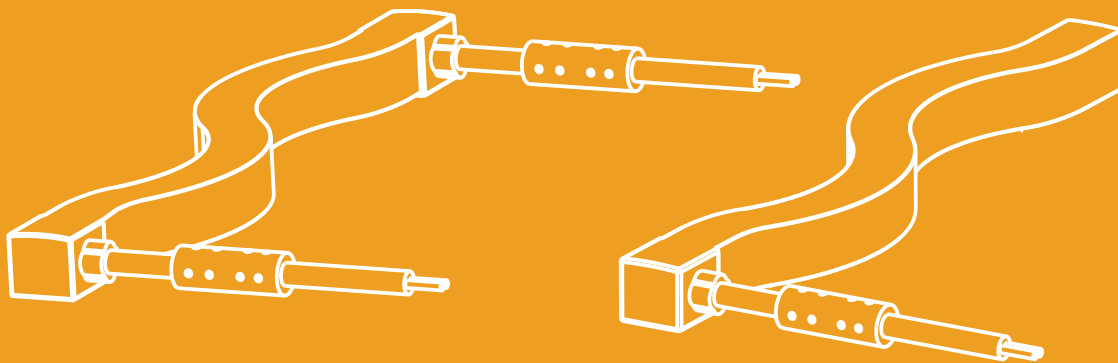

GLOW + LED STRIP

Installation and Operation Manual



USER MANUAL



TABLE OF CONTENT

PAGE	② 1. PRODUCT INTRODUCTION
② 2. SPECIFICATION
	2.1 ELECTRICAL
	2.2 DIMENSIONS (mm)
	2.3 WIRING CONNECTOR TYPE AND PART NUMBER
	2.4 POWER SUPPLY AND DIMMER
③ 3. DESIGN EXAMPLE
④ 4. MOUNTING
⑥ 5. ELECTRICAL INSTALLATION
⑥ 6. HOW TO USE GLDIYSC TO CUT THE STRIP AND END CAP ASSEMBLE
⑦ 7. DIMMER AND REMOTE OPERATION
	7.1 REMOTE OPERATION
	7.1.1 SPECIFICATION
	7.1.2 RF REMOTE BUTTON FUNCTIONS
	7.1.3 WIRELESS REMOTE CONTROL CODE VALUE SETTING METHOD
	7.1.4 REMOTE CONTROL ACCESSORIES INSTALLATION INSTRUCTIONS
	7.2 DIMMER OPERATION
	7.2.1 SPECIFICATION
	7.2.2 CONTROL METHOD
	7.2.3 CONNECTION PORT INSTRUCTION
	7.2.4 DIRECTION FOR USE
	7.2.5 PWM FREQUENCY ADJUSTMENT OPERATION:
	7.2.6 MULTIPLE DIMMER SET-UP

1. PRODUCT INTRODUCTION

The underwater LED strip is designed for to latest waterproof technologies in IP68. It is an extendable and top view bendable LED light strip tube with a 120-degree beam angle and flat rectangular emission for creating underwater profile lighting. It can be controlled by a manual or wireless remote dimmer for lighting effect tuning. The LED strip includes a range of white CCT from 2700K/3000K/3500K/4000K/4500K/5000K/5700K/6500K. To provide a long-life span, reinforced PVC material can resist the harm from UV, saltwater, flame solvents, and dirt, etc. There are seven type of wiring connectors are providing mounting flexibility for layout connections.

2. SPECIFICATION

2.1 ELECTRICAL

Operation Voltage Range: DC24V
Max Power Rating/meter: 10W
Beam angle: Top view 120 degree

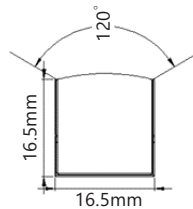

2.2 DIMENSIONS (mm)

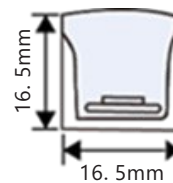
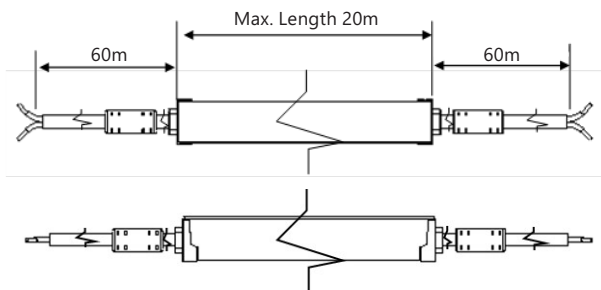

2.3 WIRING CONNECTOR TYPE AND PART NUMBER

CODE	Model	Description
9042915	GL10	LED strip max 20m length
9042901	GL10SR	Power connector side right
9042903	GL10SL	Power connector side left
9042905	GL10LR	Power connector side both
9042907	GL10SD	Power connector side direct
9042909	GL10BD	Power connector side both direct
9042911	GL10SB	Power connector side bottom
9042913	GL10BB	Power connector side both bottom

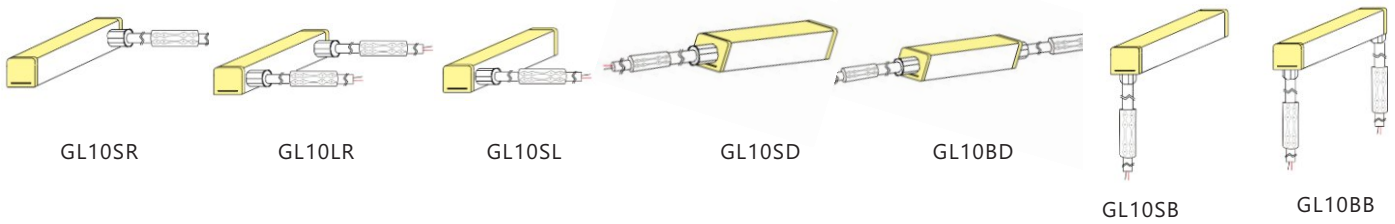

Code example: 9042915 (length 5 meter, CCT 3000K) + 9042901 = 5m LED strip, color temp 3000K with power connector side right.

2.4 POWER SUPPLY AND DIMMER

24V DC power supply provides LED strip power source and dimmer with remote control to adjust the brightness of the strip.

Code	Mode	Description
E042901	Dimmer Controller	LED Dimmer with remote
106328534	Power Supply HLG-240H-24	24V, 240W, 100-240V AC 50/60Hz input voltage, IP67
106328535	Power Supply HLG-120H-24	24V, 120W, 100-240V AC 50/60Hz input voltage, IP67

Dimmer with Remote Handset



Not in scale

3. DESIGN EXAMPLE

Design a regular shape 10x20m rectangle pool in 3000K color temperature.

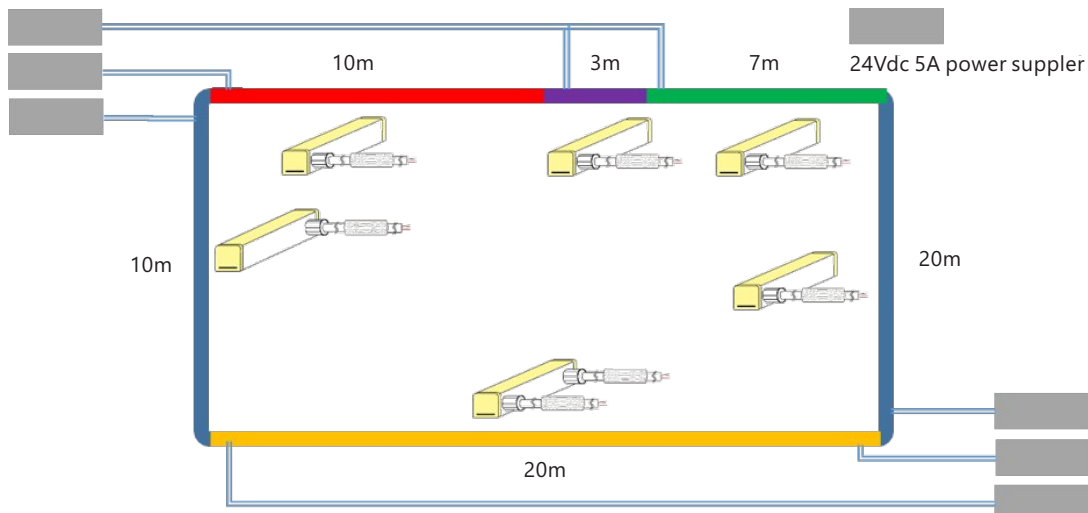

Order details for side power connection cable

Code	Description	length(m)	Quantity
9042915 + 9042901	GL10, 10m, color temp 3000K, GL10SR connector side right	10	2
9042915 + 9042901	GL10, 3m, color temp 3000K, GL10SR connector side right	3	1
9042915 + 9042901	GL10, 7m, color temp 3000K, GL10SR connector side right	7	1
9042915 + 9042903	GL10, 10m, color temp 3000K, GL10SL connector side left	10	1
9042915 + 9042905	GL10, 20m, color temp 3000, GL10LR, connector side both	20	1
105328534	24V 5A power supply		6

To configure the connector orientation for better installation convenience, change the connector model to GL10BD for both side straight connector and GL10SD for single end straight connector.

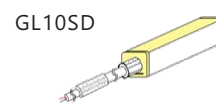
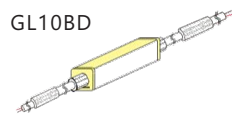

Code	Description	length(m)	Quantity
9042915 + 9042909	10m, color temp 3000K, power connector both side direct	10	3
9042915 + 9042907	3m, color temp 3000K, power connector side direct	3	1
9042915 + 9042907	7m, color temp 3000K, power connector side direct	7	1
9042915 + 9042909	10m, color temp 3000K, power connector both side direct	20	1
105328534	24V 5A power supply		6

4. MOUNTING

1. Installing the Glow+ LED stripe required at least 2 people. Make sure the bending radius is not exceeded while installation. Maximum horizontal force not exceed 10KG

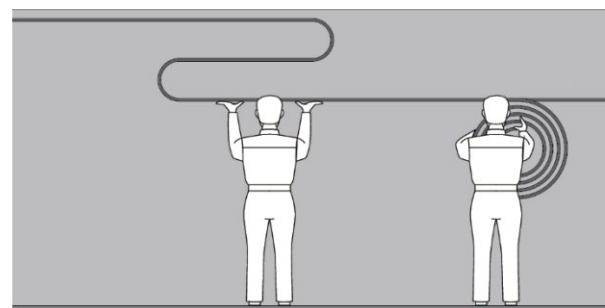
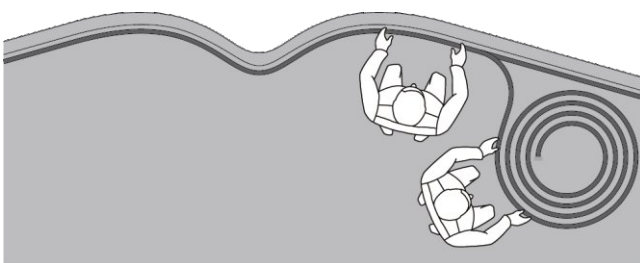
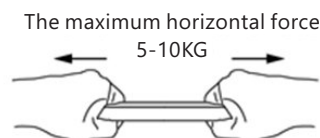

2. Mounting clip

There are 3 different length of plastic mounting accessories to fit into the mounting and one stainless steel for corner mounting reinforcement.

Code	Mode	Description
106090026	GLPMC	Plastic Mounting Clips Transparent 35mm
106090027	GLPMC1M	Plastic Mounting Channel Transparent 1m
106090028	GLSMC	Stainless steel Mounting Clip 5cm
106090029	GLDIYSC	DIY End Connector Kit



GLPMC



GLSMC



GLDIYSC

Good mounting example

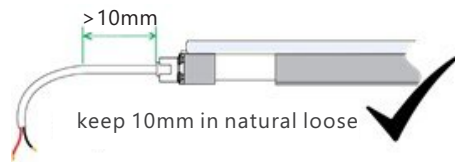
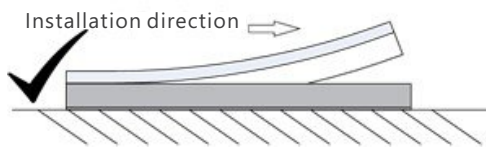
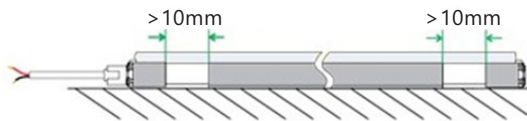

Bad mounting example

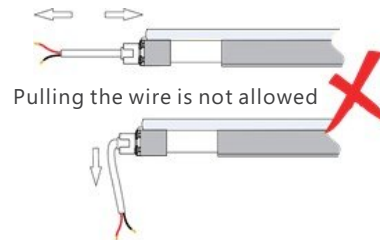
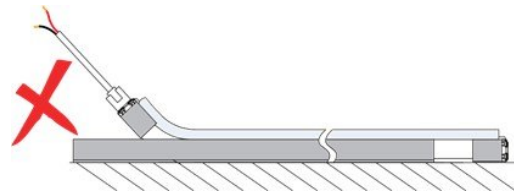
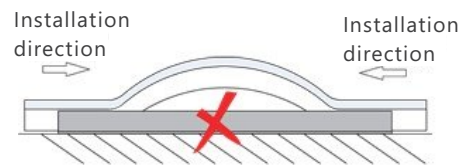

Bending:

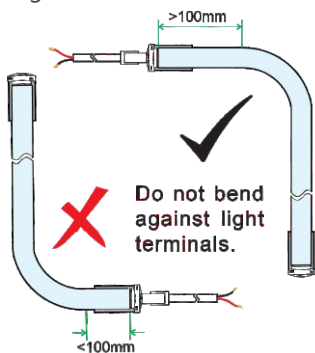

Do not bend against light terminals.

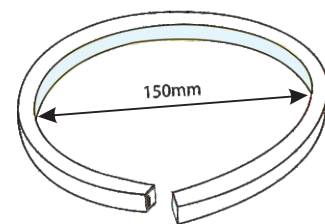
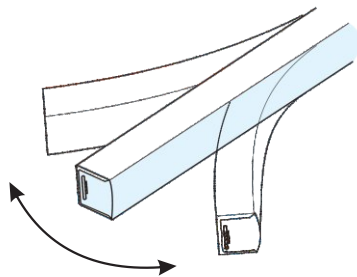

Mount the cable junction in waterproof junction box when apply to outdoor mounting.

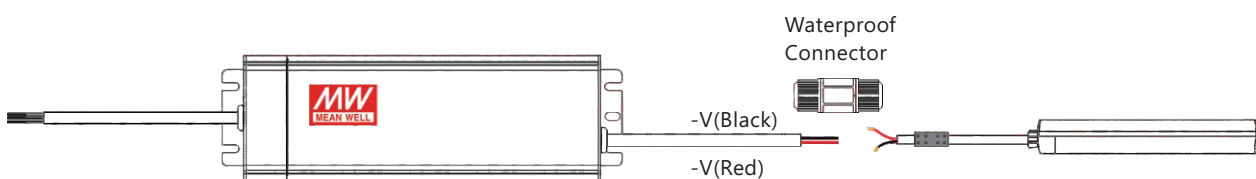

5. ELECTRICAL INSTALLATION

The system operation is 24Vdc only and current rating is 5A per 10 m strips. Therefore, a 120W minimum power supply is required to turn on the light in full brightness.

Rated power	120W	240W
LED Strip length	9.5m	19m

Locate the power supply nearby the LED strip and connect the terminal wiring. The recommended distance is as below table.

Watts of light	18AWG	17AWG	16AWG	14AWG	12AWG	10AWG
	0.82mm ²	1.04mm ²	1.38mm ²	2.07mm ²	3.29mm ²	5.62mm ²
120W	2m	2.5m	3m	4m	8m	12m

1. Connect the Red wiring of LED strip to Red wire of Power Supply.

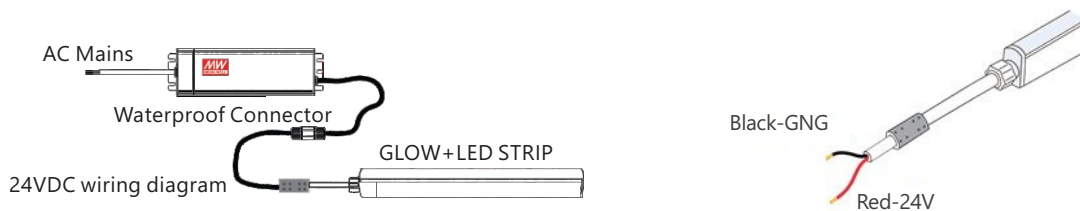

2. Wiring diagram with dimmer

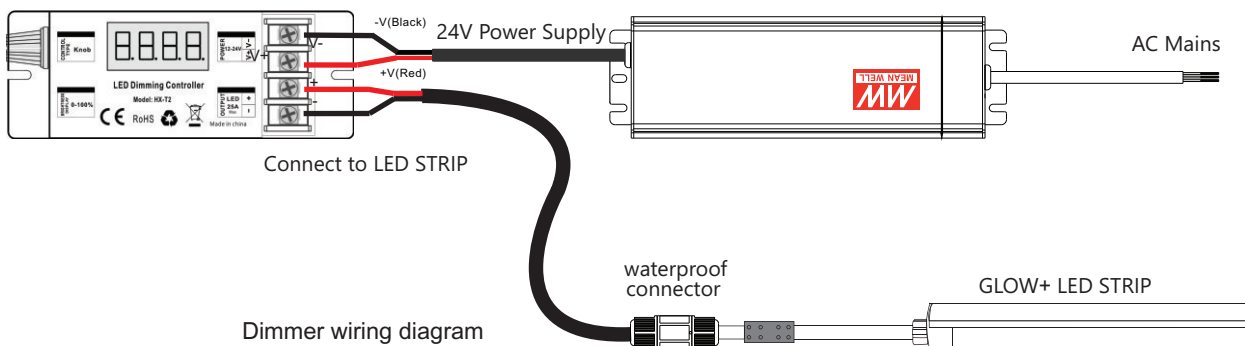

6. HOW TO USE GLDIYSC TO CUT THE STRIP AND END CAP ASSEMBLE



If it is necessary to cut the LED strip to fit into the layout, use the GLCUTTER to cut the length where marked for the "Dotted Line" or "Scissor Mark". The cut section must have the appropriate IP rated cap flex accessory to maintain water proof IP ratings.

Follow the steps below for end cap assemble after cutting.

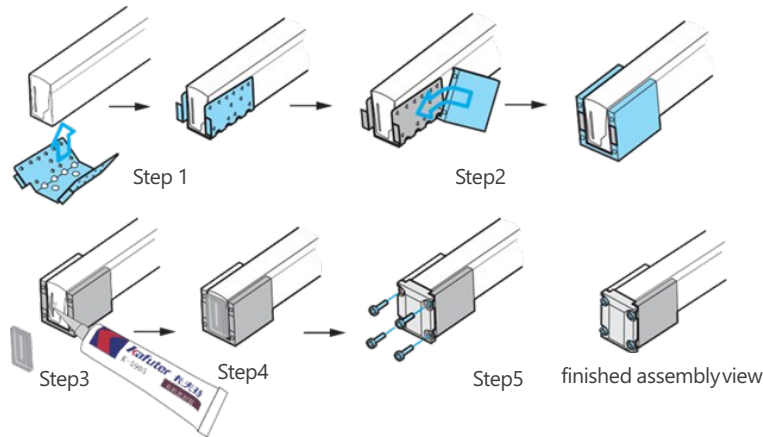

Step 1 - Place the anti-skidding clip on the very end of the tubing with the 2 tiny tabs that are pointing inwards still touching the end of the material and crimp in place.

Step 2 - Line up the aluminum mounting piece so the screw hole face the plug and slide on over the anti-skidding clip.

Step 3 - Apply 100% clear silicone onto the end face of led neon flex

Step 4 - Place the rubber gasket squarely onto the end face of led neon flex.

Step 5 - Screw the blank end to the aluminum mounting piece.

Code	Model	Description
106090030	GLCUTTER	LED Neon Cutter

7. DIMMER AND REMOTE OPERATION

7.1 Remote Operation

7.1.1 Specification

Working temperature	-20-60°C	Working voltage	3V (AAA*2PCS)
Sleep current	<25uA	Emission current	<20mA
Sleep power consumption	<75uW	Emission power consumption	<60mW
Net weight	90g	Dimension	L150*W40*20 (mm)
RF distance	≤30m	RF frequency	2.4GHz
Accessories	bracket 1pc, 3M foam sponge glue 1pc, screw 2pcs, expansion tube 2pcs.		

7.1.2 RF remote button functions

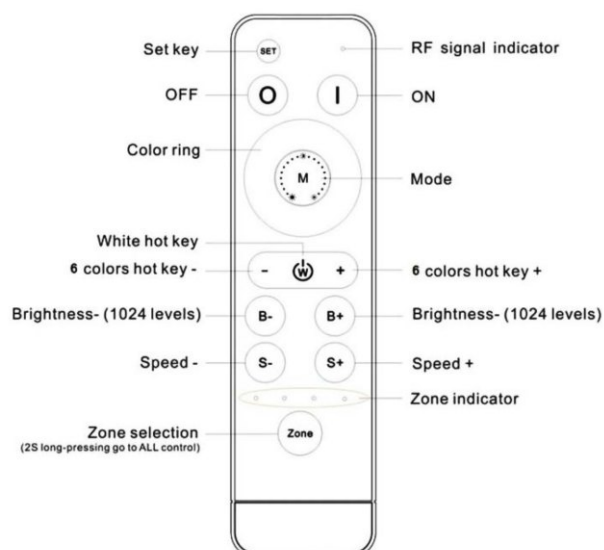

Name of key	Description
ON	ON in any time
OFF	OFF in any time
Mode	3 static modes: DIM: 20%, 50%, 100% CCT: warm white, cool white, pure white
Brightness +	Bright up the brightness by 1024 levels. Long-press will get fast adjusting.
Brightness -	Dim down the brightness by 1024 levels. Long-press will get fast adjusting.
S1-S4	<p>Short-pressing in single zone state to show the set state of corresponding zone; Short-pressing in overall-control state to show the set state of all zones.</p> <p>Scene setting operation:</p> <ol style="list-style-type: none"> 1. Selecting the right zone. 2. Pressing Scene key 5 times in 5 seconds, will enter scene setting state for corresponding zone, zone indicator light will flash. 3. Setting the right light state with "ON/OFF", "Brightness+/-", DIM/CCT ring in 30 seconds (will exit scene setting state automatically without saving when the time over 30 seconds OR pressing other keys like "Z" or other Scene button). 4. Pressing Scene key 1 time to save and finish the scene setting operation. <p>Tips:</p> <ol style="list-style-type: none"> 1. Scene setting operation for each zone is separately. "Scene control" will work for the corresponding zone only in single-zone control state; will work for the all 4 zones in overall-control state; so, it is flexible to setting up different scenes with zones. <p>The factory default state of Scene 1/2/3/4 is: DIM: 10%/30%/70%/100% brightness for all zones.</p>
Zone selection key	Zone selection, 2 seconds long-press get "all-control", indicator lights will light up accordingly.

7.1.3 Wireless remote control code value setting method

(1) Code pairing operation: means that the receiver will only be controlled by the value code remote controller.

Ste	Operation	Instructions
1	Connecting the load to the receiver and power on it.	<ol style="list-style-type: none"> 1. It is necessary to clear the code first, if the receiver was coded before. 2. Batch operation can be performed within the remote control range.
2	Select area	Select the area with the "Zone" key and the corresponding indicator lights up
3	Press and hold "ON" on the remote control for 5 seconds, the indicator of the remote control will flash quickly, means it enters the pairing code transmission status.	Will automatically exit code transmission status after 60 seconds, or pressing any key to exit.
4	See the load light flashes 3 times and return to the initial state	Pairing coding is finished successfully

(2) Code clearing operation: means that the original code value of the receiver will be cleared and returned to the factory state. Then it can be controlled by any compatible remote controller, and can learn to a new code.

Ste	Operation	Instructions
1	Connecting the load to the receiver and power on it.	<ol style="list-style-type: none"> 1. The clearing operation should be finished within 1 minutes after the receiver is powered on. If exceeds the time, can be powered on again. 2. Batch operation can be performed within the remote control range.
2	Press and hold the remote control "Off" for 5 seconds. The indicator of the remote control flashes quickly, means it enters the clearing code transmission status. There is no need to select the corresponding area when clearing code.	<ol style="list-style-type: none"> 1. Will automatically exit code transmission status after 60 seconds, or pressing any key to exit. 2. If the original remote controller is lost, the new remote controller can be used for clearing operations.
3	See the load light flashes 3 times and return to the initial state	Clearing coding is finished successfully

(3) Code learning operation between remote controls: Used to unify system code values or copy a new remote controls. Since each remote controller has its own unique code at the time of delivery, when there are multiple remote controllers in one system, one of them (for example, remote controller A) must be selected as the system code value, and the code value of the rest remote controllers (for example, remote controller B) should be copied to the same one.

Step	Operation	Instructions
1	A remote control: Press and hold "ON" on the remote control for 5 seconds, the indicator of the remote control will flash quickly, means it enters the pairing code transmission status.	Will automatically exit code transmission status after 60 seconds, or pressing any key to exit.
2	B remote control: long press "mode key" for 5 seconds, the remote indicator light changes from 100% light to 5% light and flash, means entering the code value receiving state	Will automatically exit the code value receiving state after 30 seconds, or exit after learning the code value successfully.
3	see the B remote control indicator light flash 3 times	Code copying is finished and exit code value receiving status.

(4) (4) Copying code from receiver to remote control.

A new remote control can also copy code from any one of the receivers in the whole system, after the successful operation, the new remote control can replace the original remote (if it is lost).

Step	Operation	Instructions
1	Cut off the power of receiver.	Which one will be controlled by remote.
2	Long-press "mode key" for 5 seconds, the remote indicator light changes from 100% light to off, means entering the code value receiving state.	Will automatically exit the code value receiving state after 30 seconds, or exit after learning the code value successfully.
3	Power on the receiver, will see remote control indicator light flash 3 times.	Code copying is finished and exit code value receiving status.

* For security of the system, the distance from remote control to the one receiver should be less than 2 meters in this operation.

*Only one time operation is requested for the whole system, no need different operation for different zones.

(5) The remote control restores the factory setting: it means that the remote control will be restored to the factory's unique code value.

Step	Operation	Instructions
1	Long press "mode " for 20 seconds.	The remote indicator light dim down and flashes continuously until the 20th second and then back to 100% light. Means this step is finished.
2	Press the "OFF" to confirm, the remote indicator light flashes 3 times.	Restore factory settings successfully.

7.1.4 Remote control accessories installation instructions

Accessories include bracket 1pc, 3M foam sponge glue 1pc, screw 2pcs, expansion tube 2pcs.

There are 2 options for bracket installation:

- 1) Using screw and expansion tube make drilling installation (suitable for uneven and ash surface);
- 2) Using 3M foam sponge glue make free drilling installation (suitable for flat no ash surface).

7.2 Dimmer Operation

7.2.1 Specification

Working temperature	-20-60°C	Supply voltage	DC12-24V
Output	1 channel	Static power consumption	< 1W
Max. output current	25A	Max. output power	300W/12V; 600W/24V
Net weight	65g	External dimension	L103*W40*H24 mm
Gross weight	90g	Packing size	L140*W48*H35mm
Memory function	Yes	PWM frequency	2KHz (factory default), 500Hz, 1KHz, 4KHz, 7.8KHz, 15.6KHz
Max. output current	PWM ≤ 2KHz: 25A PWM = 4/7.8KHz: 15A PWM = 15.6KHz: 10A	Max. output power	PWM ≤ 2KHz: 300W/12V; 600W/24V PWM = 4/7.8KHz: 180W/12V; 360W/24V PWM = 15.6KHz: 120W/12V; 240W/24V

7.2.2 Control method

This product can be controlled by any compatible remote control as default; if unique-control is needed, please matching the code before installation and using.

7.2.3 Connection port instruction

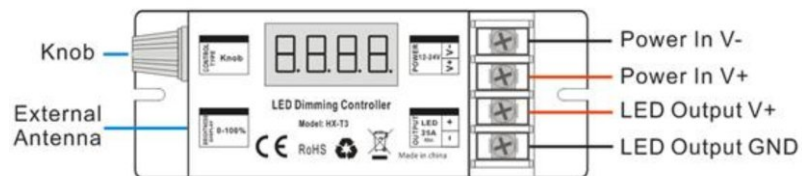

7.2.4 Direction for use

- Connect the load wire at first, followed by the power wire; Please ensure short circuit cannot occur between connecting wire before turning on the power;
- Adopt rotary button, function as follows:
Clockwise rotation to brighten up brightness to 100% as the maximum; Counter clockwise rotation to dim down the brightness to 0% as the minimum.

- PWM display: P005=500Hz; P010=1KHz; P020=2KHz (factory default); P040=4KHz, P078= 7.8KHz; P156= 15.6KHz.

7.2.5 PWM Frequency Adjustment operation:

Press and hold the remote control "Set" for 5 seconds after switch off the dimmer by remote control (the dimmer is in off state) within 10 seconds, display will show as: P***. Means enter "PWM adjusting" state. Press Brightness +/- keys to adjust the PWM frequency, pressing "Set" button again to save it after finish the setting operation. Then the dimmer returns to power on state automatically.

7.2.6 Multiple Dimmer set-up

Each dimmer can send signal to another dimmer in the same zone (please see 7.1.3 for zone setting). It is recommended that the distance between every dimmer is not greater than 10m.

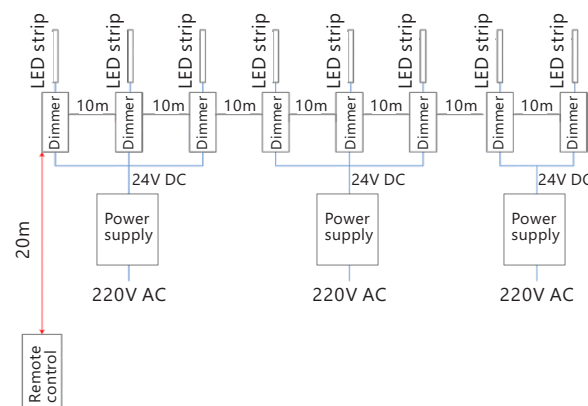

EMAUX WATER TECHNOLOGY CO., LTD

**ADDRESS FLAT A-D, 20/F., KAI BO 22, 22 WING KIN ROAD,
KWAI CHUNG, HONG KONG**

PHONE +852 2832 9880

 **YOUR PREMIER SUPPLIER**

www.emauxgroup.com