



English

Operating Manual for HEKA Incubators



HEKA-Euro-Lux I
HEKA-Euro-Lux II
HEKA-Euro-Lux III
HEKA-Euro-Lux IV
HEKA-Euro-Lux V

with separate hatching-chamber

HEKA-Euro-Lux Rom
HEKA-Euro-Lux Berlin
HEKA-Euro-Lux Oslo
HEKA-Euro-Lux Paris
HEKA-Euro-Lux Wien

HEKA-Brutgeräte

Langer Schemm 290

Tel.: +49 52 44 / 17 18

E-Mail: info@heka-brutgeraete.de

D-33397 Rietberg

Fax: +49 52 44 / 1 01 59

Preface

The purpose of this manual is to familiarise the reader with the incubator and provide instructions on use.

The operating manual contains important information for the safe, economic, and correct operation of the incubator. Compliance with this manual helps to avoid dangers, minimise repair costs and downtime, and increase the reliability and service life of the machine.

The operating manual is suitable for adding environmental protection regulations to the instructions on the basis of existing national accident prevention regulations.

The operating manual must always be kept at the place of deployment of the incubator. All individuals who are authorised to work with the incubator must read and observe the operating manual. This includes instructions in the following areas:

- Operation
- Troubleshooting
- Care and maintenance
- Transport

The operator must ensure that only authorised persons work with the incubator. The operator must check the incubator for externally visible damage and defects on a daily basis. Moreover, the operator must promptly report any changes that impair the safety. This also includes changes in the operating behaviour. The incubator may only be operated if its condition is flawless.

As a matter of principle, safety equipment must not be removed or disabled.

Should it be necessary to remove safety equipment during preparation, repair, or maintenance, the safety equipment must be reinstalled immediately upon completion of the maintenance or repair work.





The manufacturer does not assume any liability for damages resulting from unauthorised modification of the incubator.

All safety information and warnings on the incubator must be observed.

In addition to the information in the operating manual, the generally applicable safety and accident prevention regulations must also be complied with.

Structure of the safety instructions

All safety instructions have a uniform structure:

Pictogram	Signal word		
		Meaning	Consequences of non-observance
 General danger	Danger!	Imminent danger to persons	Very severe to fatal injury
	Warning!	Potentially very dangerous situation for persons	Very severe to fatal injury
	Caution!	Potentially dangerous situation for persons	Minor injury
 Dangerous electric voltage			
	Attention!	Potential damage to property	Damage to the device
		Useful information or tip	

Other notes in the operating manual

Caution! Risk of injury due to hot surface!



Warning pointing to a risk of injury to the operator from hot surfaces.



Please read and observe the operating manual.



Disconnect the power plug before opening the device.

General safety instructions!

Caution! Non-observance of the following safety precautions can result in bodily injury or damage to the incubator.



Apart from the notes listed below, please also observe the general safety and accident prevention regulations.



Read the operating manual!

Do not start using the incubator until you have read the associated operating manual.

- Do not operate the incubator on the ground. Keep a minimum distance of 50 cm from the ground!
- Do not use the incubator outdoors.
- Do not place the incubator in direct sunlight (counts also for storage and transport).
- Before connecting the incubator, compare the voltage of the power supply with the voltage on the type plate.
- In accordance with the intended use, the incubator may only be used to incubate eggs.
- Never operate the incubator if any part(s) are damaged, if it does not function properly, or if you suspect damage.
- Defective power cables may only be replaced by the manufacturer, its customer service, or a similarly qualified person.
- Maintenance work may only be performed by appropriately trained personnel.
- Repair work and special maintenance work may only be performed by authorised personnel (manufacturer's personnel) or appropriately trained personnel.
- Work on the electrical equipment may only be performed by qualified electricians and persons instructed in electrical engineering (see DIN VDE 0105).
- Working on live parts and equipment is not permitted.
- Conversion or modification of the incubator is not permitted.

Table of contents

- Preface 2
- Structure of the safety instructions 3
- General safety instructions..... 4
- Table of contents 5

- 1 Description..... 7**
 - 1.1 Technical data 8
 - 1.2 Rear side of housing 8

- 2 Setup and Connectoin..... 9**
 - 2.1 Installing the incubation trays..... 10
 - 2.2 Loading the incubator..... 11

- 3 Operating the incubator 12**
 - 3.1 Control Elements/Control Panel..... 12
 - 3.2 Switching the Incubator On/Off 12
 - 3.3 Switching the light on 13

- 4 Programming and Settings 13**
 - 4.1 Temperature..... 14
 - 4.2 Humidity 14
 - 4.3 Turning-Cycle..... 14
 - 4.4 Turning-Length 15
 - 4.4.1 Euro-Lux V, "Oslo", "Paris" and "Vienna" 15
 - 4.4.2 Euro-Lux I, II, III, IV, "Rome" and "Berlin" 15
 - 4.5 Cool-Down-Cycle 15
 - 4.6 Cool-Down-Length 15

- 5 Alarm 16**

- 6 Tips for Successful Incubation..... 17**
 - 6.1 Incubation Temperature 17
 - 6.2 Humidity 17
 - 6.3 Turning the Eggs 19
 - 6.4 Cooling the Eggs 19
 - 6.5 Inserting the hatching eggs 20

- 7 Putting the Eggs into the Hatching Trays..... 20**

- 8 Shutting-down after incubation..... 21**

- 9 Maintenance and care 22**
 - 9.1 Incubation or hatching chamber of the device 22

9.2	Technical Compartment (incubation or hatching device)	22
9.3	Incubators with a separate hatching chamber (Euro-Lux "Rome", "Berlin", "Oslo", "Paris" and "Vienna")	23
9.4	Turning device	23
9.5	Float valve	24
9.6	Replacing the power cable	25
10	FAQs – Frequent questions	25
11	Disposal.....	26
12	CE Declaration of Conformity	27
13	Appendix: Analysis of mistakes at incubation / bad hatching.....	28
14	Appendix: Incubation Periods	29

1 Description

HEKA incubators consist of a dark, almost black, waterproof plate (not chipboard) and a housing that is divided internally into two compartments:

The upper part houses the technic (distribution, controls, ventilator, heater and water supply) and the lower part houses the incubation or hatching space with the matching trays.

The EURO-LUX models are equipped with a microprocessor control. The temperature, humidity, turning time, turning interval, cooling time, cooling interval are displayed in large red illuminated digits.

Motorised incubators feature the following standard equipment:

- automatic turning mechanism, automatic humidity control, double thermostat with alarm trigger, thermal glazing.

In HEKA incubators with a separate hatching chamber, the hatching chamber is located at the top (with an associated technical compartment), and the incubation chamber at the bottom (with an associated technical compartment).

The "Rome", "Berlin", "Oslo", "Paris" and "Vienna" models each have a separate hatching compartment.

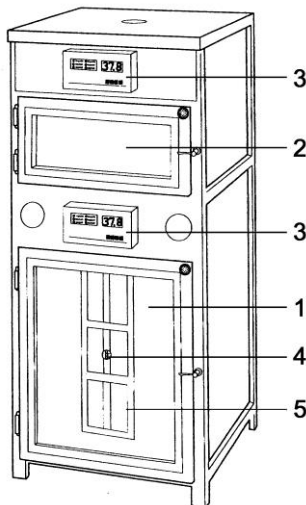

- 1 Incubation chamber
- 2 Hatching chamber
- 3 Microprocessor controls
- 4 Wing nut for fastening the grille
- 5 Grille for turning device

1.1 Technical data

HEKA-EURO-LUX Model	I	II	III	IV	V
Height in cm	59	69	79	99	119
Width in cm	53	53	68	68	68
Depth in cm	55	55	60	70	70
Approximate weight in kg	35	37	54	72	90
Power supply	230 V / 50 Hz				
Approximate power consumption in Watts (W)	380	380	500	600	700

HEKA-EURO-LUX Model	Rome	Berlin	Oslo	Paris	Vienna
Height in cm	120	130	140	150	170
Width in cm	53	68	68	68	68
Depth in cm	55	60	70	70	70
Approximate weight in kg	70	84	99	112	136
Power supply	230 V / 50 Hz				
Approximate power consumption in Watts (W)	530	700	850	1000	1000

In terms of the installation depth, the projection for the controller and the turning motor must be taken into consideration:

Model I – III and "Rome" approx. 28 cm, all other models approx. 30 cm.

1.2 Rear side of housing



Example

- 1 Housing for turning motor
- 2 Water connection

2 Setup and Connectoin

The incubator is ready to be connected.

The incubator must be set up as follows:

- Horizontal position
- Must not shake
- Door(s) must open easily
- Must not be set up outdoors and must be at least 50 cm above the ground
- Must be protected from direct sunlight
- There must be at least 5 cm of free space above the device in order to allow air circulation.
- The environment of the incubator should be well ventilated.
- The ventilation slots must not be covered.

A power supply (230 V / 50 Hz) must be available at the installation site. The incubator must not be connected to an offgrid-inverter, which are used in autonomous power-supply like solar-electricity-power-supply.

Serially, the incubator is equipped with water-canister and the matching brass-float-valve for low-pressure. The water canister must be filled with distilled water and placed in a position above the incubator (directly onto the top of the incubator or – better – hanging above the incubator).



To enable the water to flow freely, make sure there are no air bubbles in the connection hose.



If the incubator should be plugged directly to the (high-pressure-) water-mains, it must be directly ordered for this purpose or the brass-float-valve must be changed afterwards.









The ideal ambient temperate is 10°C - 20°C. However, smooth function is also guaranteed at an ambient temperature of 5°C - 28°C (with air-cooling up to 32°C – with water-cooling up to 40°C).

The humidity must be suitable for the intended purpose. Attention must be paid to the indoor humidity in particular if it is necessary to achieve a low humidity value in the device; the device can humidify but not reduce the humidity. If you choose the correct installation site, humidity values between 35-45% and 85-95% can be reached.

After setting up the device, check the incubation chamber and remove any items such as the thermometer and other accessories that were ordered and stored in the incubation chamber during transport.

After removing all foreign items from the incubation chamber, you can connect the device to the mains.

2.1 Installing the incubation trays

	<p>Example.</p> <p>Incubation trays (top)</p> <p>Hatching tray (bottom)</p>
 	<p>Place the bracket (5) for the incubation trays on the rods and secure with the wing nut (4). (strut shown here)</p>
 	<p>Place the bracket (5) for the incubation trays on the rods and secure with the wing nut (4) (grille shown here)</p>
 	<p>Push the incubation trays into the device and suspend the bolt in the slot on the bracket. After securing all the trays, tighten the wing nut (4).</p>
	<p>Hatching trays are only pushed into the device and do not need to be fastened. The bracket on the rod must be replaced.</p>

2.2 Loading the incubator



Before opening the incubator doors, switch off the incubator. This prevents unnecessary alarms.

Press the on/off switch

Ein/Aus

The incubator is switched off.

Check:

If "Off", the dot is illuminated in the display module.

Open the door.

Release the wing nut (4) (for fastening the strut or grille (5) on the turning mechanism)

Lift the strut and rotates through 90°

If you have one of the models "V", "Oslo", "Paris" and "Vienna", you need to remove the wing nut and lift up the grille and then also remove it

Pull out the incubation tray and deposit the eggs for hatching

Carefully push the incubation tray back in

Reinstall the strut (or grille) and tightened the wing nut

Close the door and switch the incubator on.

Press the on/off switch

Ein/Aus

The incubator is on.

Check:

When the incubator is "On", the actual temperature appears in the display module, and the fan(s) start(s) running.

3 Operating the incubator

3.1 Control Elements/Control Panel

 <p>The image shows the control panel of an incubator. It features a digital display showing '37.8'. To the left of the display are two columns of LED indicators: 'Temperatur' (with a red dot), 'Wasserdamp', 'Abkühlzeit', 'Faulschle', 'Wasser', and 'Abkühlzeit'. Below the display are four buttons labeled '0', '6', '5', and '4'. A yellow button is located to the left of the '0' button. The panel is labeled 'HEKA-BRUTGERÄTE' and 'Wärme- und Feuchtigkeitsregler'.</p>	<ol style="list-style-type: none">1 Dot only: "Ready for operation" otherwise: decimal point2 Display for values (°C - %) and time in minutes3 LED indicators4 Light on/off and save5 Select program and set values6 Display of the current value <p>Power on/off</p> <p>0</p>
---	---

3.2 Switching the Incubator On/Off

Press the on/off switch

Ein/Aus

Power on/off.

Check:

When "On", the actual temperature is displayed in the display module. The control status is displayed by the LED indicators.

In the active state, the corresponding LED flashes.



LED lit:

the heater is not heating

LED flashing:

the heater is heating

3.3 Switching the light on

Press 	The interior light is switched on. The lamp automatically goes off after 1 minute.
---	---





The light phase is limited to 1 minute in order to prevent excessive emission of heat to eggs close to the lamp.

For a shorter lighting period:

Press 	The lamp goes off immediately.
---	--------------------------------

4 Programming and Settings



As a general rule, you need to press the  - or  - button to select the desired value for programming.

The current actual values appear in the right-hand digital display field under temperature and humidity. The humidity display is marked by the decimal point.

For the turning time, cooling time, turning, and cooling period, the stored values are displayed.

In the basic mode, the display always shows the actual temperature.

Button 	The stored value is displayed.
---	--------------------------------









Button  or 	Set the desired value.
---	------------------------

Button  drücken	The new value is saved.
--	-------------------------











Check:	On the display, "SSS" appears for about 0.5 seconds.
--------	--

The new value is saved permanently and will be retained even in the event of a power failure.

4.1 Temperature

Press button 	The target temperature is displayed.
	The target value is 36°C to 39°C
Press button  or 	Set new target value:  = higher temperature  = lower temperature
Press button 	The new value is stored permanently.
Check:	On the display, "SSS" appears for about 0.5 seconds.
Press button 	The stored value is checked.
Press button 	The control returns to the normal starting position.

4.2 Humidity

Press button  or 	Until the "Humidity" LED is lit
Press button 	The stored target value is displayed.
Press button  or 	Sets new target value:  = higher humidity  = lower humidity
Press button 	The new value is stored permanently.
Check:	On the display, "SSS" appears for about 0.5 seconds.
Press button 	The stored value is checked.
Press button 	The control returns to the normal starting position.

4.3 Turning-Cycle

The adjustment takes place as described under "Humidity". The values are displayed in minutes. If the displayed value is 120, the eggs will be turned every 2 hours.

4.4 Turning-Length

The adjustment takes place as described under "Humidity". The values are displayed in minutes.

4.4.1 Euro-Lux V, "Oslo", "Paris" and "Vienna"

The turning duration of these devices is 1 minute.

Example: turning time = 120; turning = 1

The incubator starts turning after 119 minutes and completes turning after 1 minute.

Turning is completed after 120 minutes.

4.4.2 Euro-Lux I, II, III, IV, "Rome" and "Berlin"

The turning duration of these devices is 30 minute.

Example: turning time = 120; turning = 30

The incubator starts turning after 90 minutes and completes turning after 30 minutes.

Turning is completed after 120 minutes.

4.5 Cool-Down-Cycle

The setting is as described previously for "Humidity".

The display is in hours.

Example: Cooling time = 12

The eggs are cooled 2x a day (every 12 hours).

Cooling time = 24

The eggs are cooled 1x a day (every 24 hours).

Caution!



The cooling period must be set.

Cooling does **not** occur if you do not set a cool-down-length (value: 0; see below)

4.6 Cool-Down-Length

The adjustment takes place as described under "Humidity". The values are displayed in minutes (adjustment range: 10 – 120 minutes).

The cooling period is the time during which the heaters are turned off.

The cooling period of the incubator depends heavily on the ambient temperature.



Normally, cooling is not performed at the hatching stage. Therefore, the cooling period should be set to 0 minutes during this time.

5 Alarm

HEKA incubators are serially equipped with double-thermostat and alarm. If the device reaches an excess temperature of 0.5° C, due to a malfunction, wrong handling (air-vents fully closed, door opened too long without swithing-off the incubator) or external influences (insolation), it automatically switches to alarm. The alarm is indicated visually and audibly, that is, the display flashes at regular intervals and it also emits a beep at regular intervals.

Emergency shut off is enabled and all heating systems are switched off.

The device cools down to the set target value and then continues to work in the normal way.

The buzzer and the flashing display persist.

Stopping the alarm

Press the on/off-button **Ein/Aus** 2x: the alarm stops



An alarm can be caused, if the door is opened for too long; because heat and humidity escapes and the temperature and humidity sensors detect incorrect values.

The microprocessor now attempts to compensate for the low values and this causes the heating systems to heat up considerably. After closing the door, the extremely hot heating elements take effect and this causes an excess temperature for a few minutes so that an alarm is triggered.



Caution!

Switch off the incubator before opening the incubator doors in order to prevent the alarm from being triggered as described above.

Press the on/off-button **Ein/Aus** : the device is off.

6 Tips for Successful Incubation

6.1 Incubation Temperature

Generally, we recommend a temperature of 37,8°C. For incubating bantam, quails or pheasants (partly also ducks and geese) we recommend 37,5-37,6°C - for raptors, parrots and parakeet a temperature of 37,0-37,2°C. If different (poultry-)eggs are incubated together, you should set a temperature of 37,7-37,8°C. Ostriches, rheas and nandus are an exception with much less temperature.

6.2 Humidity

Apart from the temperature, the incubation humidity plays a significant role for the incubation results. During incubation, every egg must lose weight. The weight loss must amount to at least 15% of the fresh egg. A weight loss of 17% is ideal. You can check this with a special accuracy weighing machine – breeders of very valuable (and thus mostly sensitive, difficult to incubate) animals weigh every single egg every day and adjust the humidity according to the weight-loss to come to 100% hatching success (the higher humidity, the less weight-loss; and vice versa).

With the weight-loss comes along a steadily growing air cell. This can be checked with a candling-lamp to adjust the humidity (if necessary; the less humidity, the bigger the air cell). The air cell must be steadily growing over the complete time of incubating – until shortly before hatching it takes about one-third of the egg.

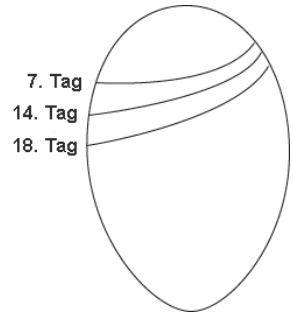

Fig.: Optimum size of the air cell in a chicken-egg (incubation-length: 21 days)

Due to the different characteristics of the eggshell, a different humidity is necessary for various kinds of fowl to come to the right weight-loss and size of the air cell. For example, a chicken egg (at the same humidity) loses weight much more slowly than a waterfowl egg.

The weight-loss even varies for chicken of different types, which means that the eggs normally should be incubated at different humidity levels. The weight loss is also determined by the size of the egg. In practice incubating with different values of humidity mostly is not possible. Thus, we recommend well-proven mean values, which experiental lead to very good hatching-results:

Chicken and bantam eggs	53 %
Goose eggs	57 – 58 %
Duck eggs	60 – 63 %
Pheasant eggs	48 – 53 %
Quail eggs	53 %
Ostrich eggs	19 – 23 %
Emu eggs	40-45 %
Rhea eggs	53-58 %

But please note, that there are also considerably outliers because of the characteristics of the eggshell (e.g. Marans: 40-45%) and/or the climate of their natural habitat (e.g. Crested-partridge 65-70%; Muscovy ducks 50-55%).

For parakeet and parrot eggs general recommendations are not possible, because the required humidity varies extremely. The required humidity depends on the location of their natural breeding areas (humid tropics or dry savanna). For incubating species from very arid/dry habitats normally you need a humidity as low as possible (viz.: no water in the incubator/water basin; air-vent(s) fully open). Only in the hatching stage the humidity is raised as normal.



When you take eggs out of the incubator for weighing or candling and thus you switched on the light – don't forget to switch it off again.

Light should not be switched on (when door closed) longer than 5 minutes.



In case of failing water-supply to the incubator (because of missing water in the tank or stuck valve) you must set the humidity to „0“, because otherwise the alarm will be activated.

6.3 Turning the Eggs

Expert opinions vary considerably concerning the turning interval.

The purpose of turning the eggs is to prevent the embryo from sticking to the egg and dying. This objective already is reached by turning the eggs three times within 24 hours. On the other hand, practical experience has shown that continuous turning at intervals of 2 hours (setting: turning-cycle 120, turning 30 or 1) has an extremely positive effect on the incubation results.

Chicken eggs must be turned from the third day after insertion, and duck and goose eggs from the fourth day.

In the last 3-4 (depending on the incubation period) of hatching, the turning must be deactivated (setting: turning-cycle 120, turning-length 0).



Though this is not necessary, the hatching eggs can be turned from the first day without being damaged.

6.4 Cooling the Eggs

In this field, too, experts express different opinions.

However, it is undisputed that the eggs of wildfowl and waterfowl must be cooled. The cooling strengthens the embryo in the egg. The cooling period depends heavily on the ambient temperature.

As a general rule, wildfowl and waterfowl must be cooled once a day, at least to an extent that the egg no longer feels warm and the temperature display drops below 30°C.

Especially when incubating goose eggs, cooling is an important factor that has a decisive effect on the hatching result.

We recommend cooling goose eggs once a day from the 11th to the 27th incubation day (when incubation period is 30 days). The cooling-length should be at least 30 minutes, though longer cooling phases are not detrimental.



If the device stands in a temperate room, a cooling period of about 60-90 minutes is necessary.

For a hen's eggs, cooling in HEKA-EURO-LUX incubators is not absolutely necessary, but recommended.

The strengthening of the embryo results in a shorter hatching phase, both for wildfowl and for waterfowl.



The cooling times are shorter for chicken eggs.
We recommend 20-30 minutes.

Generally, we consider one cooling cycle per day to be sufficient.

Airing by opening the door is not necessary in HEKA incubators. The incubated eggs are supplied with an adequate amount of oxygen by the fan(s) and the air-vent(s).

For good hatching results, it actually makes sense to keep the device closed whenever possible and only to open it if you need to take some action such as candling, weighing, reloading, etc.

6.5 Inserting the hatching eggs

After setting the correct humidity and temperature values, place the eggs (horizontal or slightly vertical with air cell on top) on the incubation trays in the incubator.

Attention!



Handle the hatching eggs with care. Especially hatching eggs whose incubation process has started are very sensitive.

Please make sure that the eggs are not too old. (max. 10 - 14 days). If you store the eggs more than 4-5 days: daily turn the eggs, don't store too dry, optimum temperature: 12-15°C.

7 Putting the Eggs into the Hatching Trays

3 days before the date of hatching the eggs should be put into the hatching trays or into the hatcher; the eggs must not be turned anymore. Switch off the turning. In the hatching stage all eggs need a higher humidity than in the incubation stage. Humidity should be 20-25% higher than before in the incubation stage (e.g. from 53% to 73-78%). Raising of the humidity should be made in steps. First day 10% more, next day again 10% more – and when the chicks begin to come out of the eggs again some percentage more.



Don't raise the humidity to more than 90% - otherwise there's risk of chicks not drying and having water (condensed) on the bottom of the incubator. When the pane of a double-glass door begins to steam up, reduce the humidity a bit. Only for waterfowl and other eggs, which already needed very high humidity in the stage of incubating, it can be necessary or helpful to have such a high humidity (of 80-90%), that the double-glass pane begins to steam up.

If you use simple hatching trays (without cover), place them central, so that to the door and to the back you just have little space left. Nevertheless, with very agile chicks it can happen, that some hop over the edge of the hatching tray. To avoid risk of drowning in the water basin, cover the water basin with mesh-wire or net – or alternatively use our pedigree-hatching-trays with cover and partitions.



To come faster and/or to higher humidity at hatching, you can take away the cover on the stainless-steel-basin with the water-heating-element. Switch off the incubator, unplug from power-mains and wait at least 5 minutes, before you then take away the lid of the incubator.

8 Shutting-down after incubation

When you have had hatching in the incubator and plan to put in eggs shortly, make at least a light maintenance and care according to chapter 9. Empty the water-reservoir (or disconnect it from the water-mains) and also empty the stainless-steel water-basins (water-heating and floater) inside the incubator – and set the humidity to “0”, so that the incubator won't activate the water-heating. Run the incubator without water until the humidity has fallen to that value, which you need for the next incubation.

If you don't plan to put in eggs shortly, make maintenance and care like described in chapter 9. Switch-on again the incubator after maintenance and care (without water in the water-basins and humidity set to “0”) and run it until the humidity doesn't fall anymore. Depending on the room, weather conditions and season this will be 30-50%. Thus you avoid, that high humidity (from last hatching or from cleaning) remain in the incubator without possibility to really get it out while storage / until next incubation.

Afterwards switch off and unplug the incubator.

9 Maintenance and care

9.1 Incubation or hatching chamber of the device



We recommend cleaning the hatching device or incubator thoroughly and disinfecting it after every major hatch.

Attention!



After disinfection, the incubator must be ventilated according to the manufacturer's instructions. We recommend waiting a few days before using the hatching device/incubator again.

The incubation chamber and the incubation trays must be cleaned and disinfected regularly. To do this:

- Open the hatching device/incubator
- Remove the hatching/incubating trays
- Clean and disinfect the hatching/incubating chamber and the hatching/incubating trays (with “Amo-Des” or “Euphagol”)
- Reinstall the hatching/incubating trays

9.2 Technical Compartment (incubation or hatching device)



Disconnect the power plug before opening the cover.

Caution! Dangerous voltage!



Before cleaning, disconnect the power plug to make sure no voltage is present.

Caution! Danger of injury from hot surface!



Before opening the lid, wait for approximately 10 minutes until the heating elements have cooled off.

Regularly clean and disinfect the "technology compartment" under the lid:

- Unscrew the screws at each corner of the incubator cover (total of four).
- Lift the lid, exerting slight pressure.
- Empty the stainless-steel water-basins
- Remove incubation dust, incubation dirt, and residue
- Disinfect the hatching device/incubator (with “Amo-Des” or “Euphagol”)
- Close the lid.
- Re-tighten the screws.

9.3 Incubators with a separate hatching chamber (Euro-Lux "Rome", "Berlin", "Oslo", "Paris" and "Vienna")

Attention!

Remove the hatching incubator before cleaning the pre-incubator.

- Release the hose clamp on the hatching incubator (rear side)
- Disconnect the hose connection between the pre-incubator and the hatching incubator.
- Disconnect the power supply between the pre-incubator and the hatching incubator.
- Remove the terminal cover (at the back).
- Remove the 3-wire cable.
- Remove both lateral screws in the side panel.
- Remove incubator
- Clean and disinfect the hatching incubator and pre-incubator as described (see above)
The devices are re-assembled in the reverse order.

9.4 Turning device

Lubricate the threaded rod of the turning mechanism once a year.

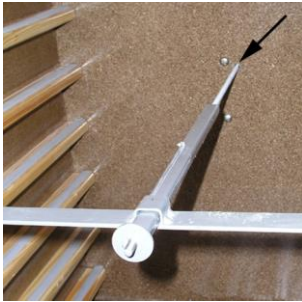

Move the threaded rod all the way to the front and grease it (arrow).

The grease will spread in the thread as the rod is moved back.

At incubators with our big 3phase-motor (identifiable, if 6 or more trays are turned by just 1 motor), additionally you have to grease directly at the turner-motor (at the back of the incubator) with a grease gun.

9.5 Float valve

Due to knocks during transport, undesigned adjustment at cleaning or impurity it can happen, that the water supply does not work correctly. Open the lid of the incubator according to the description and the safety warnings in chapter 9.2 (maintenance and care: technical compartment) and Follow these steps:

1. Check, if both stainless-steel water-basins are filled up to ~0,5-1cm below the edge of the water-basins. If only the basin with the water-heating is not filled sufficiently, the tube between the two basins is blocked and must be cleaned. If both basins are not filled sufficiently, go on with the next point:
2. Check, if the brass-float-valve is exactly vertical and does not stuck in its table-track (at the basin). If the floater "jumped" out of its position or got stuck, just correct its position. If the water-reservoir is on/over the incubator, water directly will (slowly) run into the basin(s). Wait, until the final filling-level is reached. If water seems to rise above the edge of the basins, adjust the brass-float-valve to a slightly lower position (with the wing-nut at the arm of the floater).
If this should not help, go on with the next point:
3. Close the lid of the incubator and set the humidity to "0". Run the incubator as long as possible (at least 60min.).
4. Take away the lid of the incubator again.
5. Unscrew the wing-nut of the brass-float-valve.
6. Pull the front-bar of the floater to the highest position (= max. filling-level).
7. Tighten the wing-nut.
8. With the screw-thread at the back-part of the floater you also adjust the filling-level of the water-basins. This screw must not be tightened completely! The more you unscrew it, the higher the filling-level (and vice versa).
9. Let water run in until the water-basins are filled sufficiently (~0,5-1cm below the edge) and adjust the wing-nut and/or the screw-thread so that this water-level is hold.
10. Don't let the incubator be unobserved, because overflowing water can lead to damages of the incubator.
11. Empty the water-basin of the water-heating and check, if the right filling-level is reached again without making any adjustments. Failing this: repeat steps 7-10.
12. Close the lid and screw it. Set humidity to the desired value.

If this proceeding does not help, the seal of the brass-float-valve is dirty or torn or the pipe-fitting for the water-tank in the back-wall of the incubator is dirty. Unplug the water-tank at the back of the incubator and also unscrew the brass-float valve inside the incubator (point 9). Clean the hole in the pipe-fitting (which now still is mounted in the back-wall of the incubator) – if this hole is blocked by debris, no water can run into the incubator. Also clean the black seal in that part of the brass-float-valve, which you have demounted. If this seal should be

swollen or torn (durability: ~10 years), it must be changed, because a swollen seal can't open the valve wide enough.

9.6 Replacing the power cable

Attention!



Defective power cables may only be replaced by the manufacturer, its customer service, or a similarly qualified person.

10 FAQs – Frequent questions

- "Why do I need to set the device up 50cm above the floor?"
 - To protect it against flooding.
- "The device is not turning."
 - 1. The device does not turn continually, but for 30 minutes every 2 hours. Mark the eggs and check if they have been turned after 2 hours.
 - 2. You have entered the wrong values in the turning program. Refer to Chapter 4.3 and 4.4 on p.14f for details.
- "The actual humidity is above the set humidity level."
 - The device only has a humidifier; it does not have a dehumidification-system. Operating the heater and ventilator can bring the humidity down to ~10% below the ambient humidity. If necessary, install the device in a drier room. If you need an extremely low humidity level for exotic birds, remove the water from the water-tank and the stainless steel basins in the technical compartment. And set the humidity to "0", so that the incubator won't try to make humidity.
- "The actual humidity is below the set humidity level."
 - Check, that the tube does not runs below the brass-float-valve and that there are no air bubbles in the tube (chapter 2)
 - Check, that the water-tank is filled enough with water
 - Check the brass-float-valve (chapter 7.3)
 - If both stainless steel tanks are filled with water and you are still unable to achieve sufficient humidity, this is due to the ambient temperature being too high. To avoid excess temperature in the device, the water heater for generating humidity is only actuated if the device needs to generate more heat. You can check that the humidifier is working correctly by opening the door and thus allowing cold air to enter the device. The device now needs to generate more heat, which also generates humidity (LED for "Humidity" flashes, water heater becomes warm). Place the device in a colder room to achieve the

preset humidity value. Additionally, opening the air-vent(s) can help as this allows warm air to escape from the device so that it needs to generate more heat.

11 Disposal



WEEE reg. no.:
DE 96968236

The sticker with the crossed out wheeled bin on this product indicates that this product must not be disposed of as domestic waste. To avoid a potential impairment of the environment or human health, this product must not be treated as domestic waste but must be recycled in an eco-friendly manner.

For information concerning disposal, please contact the manufacturer of the product. We will have your product collected by a forwarding agent.

HEKA-Brutgeräte Tel: +49 5244 1718
Langer Schemm 290 Fax: +49 5244 10159
D-33397 Rietberg

12 CE Declaration of Conformity

Manufacturer HEKA-Brutgeräte
address Langer Schemm 290 D-33397 Rietberg,
Germany

hereby declares that the

Product HEKA-Euro-Lux incubator
Models HEKA-Euro-Lux I, II, III, IV, V
HEKA-Euro-Lux Rome, Berlin, Oslo, Paris,
Vienna

is in conformity with the following directives:

- 98/37/EC Machinery Directive
- 73/23/EEC Low Voltage Directive
- 2004/108/EC EMC Directive

The following standards were used to assess the conformity:

- DIN EN ISO 12 000-1
- DIN EN ISO 12 000-2
- DIN EN 60 204-1
- DIN EN 60 335-1
- DIN EN 60 335-2-71



The conformity of the products with the above-mentioned standards and directives is confirmed with the CE mark.

A handwritten signature in black ink, which appears to read 'Christa Hemel'.

Rietberg, 20 August 2006

Christa Hemel

13 **Appendix: Analysis of mistakes at incubation / bad hatching**

Normally, 5-10% of the eggs are unfertilized. If less than 70-80% of the remaining chicks hatch, you should analyse the reason(s) to have better success at next hatching. Analysing the symptoms first of all allow the following conclusions (further reading in specialized books), whereof “too high humidity in incubating stage” is the absolutely most frequent mistake.

Mostly died in first week:

Wrong storage of eggs, parental predisposition, virus infection, incubation-temperature much too high/low, no turning, (too long) cooling of eggs

Mostly died in second week (without huge loss in first week):

Huge parental vitamin deficiency, infection in incubator, overheating or undercooling at candling, too high (seldom: too low) humidity at incubation, oxygen deficiency

Mostly died in third week before beginning of respiration by lung (without huge loss before):

All a.m. factors, especially too high or too low humidity in incubation stage

Died at hatching, eggshell circular scored:

Too low humidity at hatching stage

Died at hatching, eggshell pierced (central or astride; liquid leaves at pierced point):

Too high humidity at hatching stage

Hatched chicks stick at eggshell:

Too low humidity (especially at hatching stage)

Hatched chicks are clammy:

Too high humidity at incubation stage

Hatched chicks uncleanly cut the cord:

Too high temperature or oscillations in temperature

Hatched chicks with stressed respiration:

Too high humidity in incubation stage, too less humidity at hatching stage, temperature too high at hatching stage

Hatched chicks malformed:

Temperature too high/low or oscillating, heredity

14 Appendix: Incubation Periods

Domesticated Birds:

Bantam:	19-21 Days
Chicken:	21 Days
Ducks:	28 Days
Geese:	28-35 Days
Guineafowl:	27 Days

Muscovy Ducks:	35 Days
Peacocks (all species):	28 Days
Pigeons:	16-18 Days
Turkeys:	28 Days

Wild Birds

Mallards:	25-26 Days
Partridges:	23 Days
Pheasants:	24 Days

Quails:	23 Days
Vulturine Guineafowl:	23-24 Days

Flightless Birds

Emu:	57-62 Days
Rhea:	35-40 Days

Ostrich:	35-42 Days
----------	------------

Pheasants

Alectoris:	23-26 Days
Amherst's Pheasant:	23 Days
Arborophila:	20-24 Days
Barbary Partridge:	25 Days
Black Francolin:	18-19 Days
Blood Pheasant:	28 Days
Blue Eared Pheasant:	26-28 Days
Brown Eared Pheasant:	26-27 Days
Bulwer's Pheasant:	25 Days
Copper Pheasant:	24-25 Days
Crested Argus:	25 Days
Crested Fireback:	24-25 Days
Crestless Fireback:	24-25 Days
Cheer Pheasant:	26 Days
Edward's Pheasant:	21-23 Days
Elliot's Pheasant:	25 Days
Gallopheasants:	23-25 Days
Golden Pheasant:	23 Days

Great Argus:	25 Days
Himalayan Snowcock:	27-28 Days
Hume's Pheasant:	27 Days
Junglefowl:	19-21 Days
Koklass Pheasant:	21-23 Days
Lewis's Silver Pheasant:	23 Days
Mikado Pheasant:	26-28 Days
Monals:	27 Days
Peacock-Pheasants:	21-22 Days
Red-legged Partridge:	23-24 Days
Reeves's Pheasant:	24-25 Days
Salvadori's Pheasant:	22-25 Days
Sand Partridge:	27 Days
Silver Pheasant:	25 Days
Sri Lankan Junglefowl:	18 Days
Swinhoe's Pheasant:	25 Days
Tragopans:	28 Days
White Eared Pheasant:	24 Days

Quails

Banded Quail:	21-23 Days
Bearded Tree Quail:	28 Days
Brown Quail:	20-22 Days

Montezuma Quail:	25-26 Days
Mountain Quail:	24-25 Days
New Zealand Quail:	21 Days

California Quail:	22-23 Days	Northern Bobwhite:	21 Days
Crested Bobwhite:	22-23 Days	Painted Bush Quail:	16-18 Days
Crested Partridge:	18-20 Days	Rain Quail:	18-19 Days
Harlequin Quail:	14-16 Days	Scaled Quail:	23 Days
Japanese Quail:	18 Days	Spot-Winged Wood-Q.:	18-19 Days
King Quail:	18 Days	Yucatan Bobwhite:	23-24 Days
Long Tailed Quail:	28 Days		

Grouse

Black Grouse:	26 Days	Ruffed Grouse:	24 Days
Dusky Grouse:	25 Days	Sharp-tailed Grouse:	24-25 Days
Greater Prairie Chicken:	24-25 Days	Spruce Grouse:	21-22 Days
Hazel Grouse:	25 Days	Western Capercaillie:	26-28 Days
Red Grouse:	22 Days	Willow Ptarmigan:	23 Days
Rock Ptarmigan:	20-21 Days		

Swans

Bewick's Swan:	30 Days	Mute Swan:	37 Days
Black-necked Swan:	36 Days	Trumpeter Swan:	33 Days
Black Swan:	36 Days	Tundra Swan:	36 Days
Coscoroba Swan:	35 Days	Whooper Swan:	36 Days

Geese

Bar-headed Goose:	28 Days	Hawaiian Goose:	29 Days
Barnacle Goose:	28 Days	Lesser White-fronted G.:	25 Days
Brant:	22 Days	Pink-footed Goose:	28 Days
Canada Goose:	28 Days	Red-breasted Goose:	25 Days
Emperor Goose:	24 Days	Ross's Goose:	23 Days
Fighting Geese:	28-31 Days	Snow Goose:	25 Days
Greater White-fronted Goose:	26 Days	Taiga Bean Goose:	25-29 Days
Greylag Goose:	28 Days	Toulouse Goose:	30 Days

Anserinae

Andean Goose:	30 Days	Kelp Goose:	32 Days
Ashy-headed Goose:	30 Days	Orinoco Goose:	30 Days
Blue-Winged Goose:	31 Days	Ruddy-headed Goose:	30 Days
Egyptian Goose:	30 Days	Upland Goose:	30 Days
Freckled Duck:	26-28 Days		

Whistling Ducks

Black-bellied Whistl. Duck: 28 Days
 Fulvous Whistling Duck: 28 Days
 Lesser Whistling Duck: 28 Days
 Plumed Whistling Duck: 30 Days

Spotted Whistling Duck: 31 Days
 Wandering Whistl. Duck: 30 Days
 West Indian Whistl. Duck: 30 Days
 White-faced Whistl. Duck: 28 Days

Anatidae

Cape Barren Goose: 30 Days
 Radjah Shelduck: 30 Days

Ruddy Shelduck: 30 Days
 Shelduck: 30 Days

Perching Ducks

Australian Wood Duck: 30 Days
 Knob-billed Duck: 30 Days

Mandarin Duck: 32 Days
 Wood Duck: 32 Days

Eider Ducks

Common Eider: 24 Days
 King Eider: 22 Days

Spectacled Eider: 24 Days
 Steller's Eider: 24 Days

Teals

Baikal Teal: 24-28 Days
 Blue-winged Teal: 24 Days
 Brazilian Teal: 25 Days
 Bronze-winged Duck: 30-31 Days
 Brown Teal: 28 Days
 Cape Teal: 25 Days
 Chestnut Teal: 26 Days
 Cinnamon Teal: 24 Days
 Garganey: 24 Days
 Green-winged Teal: 24 Days

Grey Teal: 25 Days
 Hottentot Teal: 24 Days
 Marbled Duck: 25 Days
 Puna Teal: 26 Days
 Red-billed Teal: 25-28 Days
 Ringed Teal: 24-28 Days
 Sharp-winged Teal: 24 Days
 Silver Teal: 25 Days
 Yellow-billed Teal: 24 Days

Shovelers

Australian Shoveler: 24 Days
 Cape Shoveler: 26 Days
 New Zealand Shoveler: 26 Days

Nordic Shoveler: 25 Days
 Red Shoveler: 25 Days
 Shoveler: 26 Days

Wigeons

American Wigeon: 24 Days
 Chiloé Wigeon: 26 Days
 Eurasian Wigeon: 25 Days

Falcated Duck: 25 Days
 Gadwall: 26 Days

Oxyurinae			
Masked Duck:	24 Days	White-backed Duck:	26 Days
Ruddy Duck:	24 Days		
Mergansers			
Goosander:	30 Days	Red-breasted Merganser:	30 Days
Hooded Merganser:	28 Days	Smew:	28 Days
Goldeneyes			
American Goldeneye:	28 Days	Eurasian Goldeneye:	28 Days
Bufflehead:	22 Days	Barrow's Goldeneye:	30 Days
Pintails			
Chilean Pintail:	25 Days	White-cheeked Pintail:	25 Days
Northern Pintail:	22-23 Days	Yellow-billed Pintail:	25-26 Days
Mallards			
African Black Duck:	28-30 Days	Mottled Duck:	26 Days
American Black Duck:	26 Days	Pacific Black Duck:	26 Days
Hawaiian Duck:	26 Days	Philippine Duck:	26 Days
Indian Spot-billed Duck:	26 Days	White Pekin:	28 Days
Laysan Duck:	26 Days	Yellow-billed Duck:	27 Days
Mallard:	26 Days		
Pochards			
Baer's Pochard:	27 Days	Red-crested Pochard:	27 Days
Canvasback:	26 Days	Redhead:	28 Days
Common Pochard:	27 Days	Ring-necked Duck:	23-26 Days
Ferruginous Duck:	26 Days	Rosy-billed Pochard:	28 Days
Greater Scaup:	24-28 Days	Southern Pochard:	26 Days
New-Zealand Scaup:	26 Days	Tufted Duck:	25 Days
Scoters			
Common Scoter:	28 Days	Long-tailed Duck:	23 Days
Harlequin Duck:	30 Days	Velvet Scoter:	28 Days
Doves			
Collared Dove:	14 Days	Galápagos Dove:	16 Days
Common Ground Dove:	12-14 Days	Gallicolumba:	15 Days
Common Wood Pigeon:	15 Days	Laughing Dove:	13 Days
Crested Pigeons:	17-19 Days	Mourning Dove:	15 Days

Diamond Dove:	13 Days	Namaqua Dove:	14-15 Days
Domestic Pigeon:	17 Days	Rock Dove:	17 Days
Eurasian Collared Dove:	16 Days	Western Crowned Pigeon:	28 Days
European Turtle Dove:	14 Days		

Parrots / Parakeets / Oscine Birds

Amazonas Parrots:	24-29 Days	Major Mitchell's Cockatoo:	27 Days
Black-Capped Lory:	23-26 Days	Medium Parrots:	18-20 Days
Blue-and-yellow Macaw:	28 Days	Red-tailed Black Cockat.:	28 Days
Blue Eyed Cockatoo:	28 Days	Red-vented Cockatoo:	28 Days
Blue-winged Macaw:	24-26 Days	Salmon-crested Cockatoo:	30 Days
Budgerigar:	18 Days	Scarlet-chested Parrot:	18 Days
Citron-crested Cockatoo:	24 Days	Solomon Island Parrot:	28-30 Days
Domestic Canary:	13 Days	Sulphur-crested Cockatoo:	30 Days
Galah:	23 Days	Sun parakeet:	26 Days
Gang-gang Cockatoo:	25-27 Days	Tanimbar Corella:	28 Days
Grey Parrot:	26-30 Days	Western Corella:	23-24 Days
Hyacinth Macaw:	24-29 Days	White Cockatoo:	28-30 Days
Large Parrots:	23-25 Days	Yellow-crested Cockatoo:	24 Days
Little Corella:	29 Days	Yellow-naped Amazon:	25-27 Days
Long-billed Corella:	29 Days	Yellow-tailed Black Cock.:	29 Days
Macaws:	26-28 Days		

Birds of Prey / Owls

Amur Falcon:	28-30 Days	Gyrfalcon:	30-32 Days
Barn Owl:	32 Days	Northern Goshawk:	35-37 Days
Black Kite:	32 Days	Peregrine Falcon:	34 Days
Common Kestrel:	30 Days	Red Kite:	35 Days
Eurasian Eagle-owl:	33 Days	Tawny Owl:	32 Days
Eurasian Pygmy Owl:	28-30 Days		

No responsibility is taken for the correctness of this information!

You are welcome to tell us corrections and additions!

