

Eclipse Square

Architectural Surface / Suspended Luminaire



PROJECT: TYPE: DATE:

NOTES:

Specification grade architectural round fixtures deliver minimalistic and distinctive lines that are able to endorse any design of hospitality, retail and commercial space.

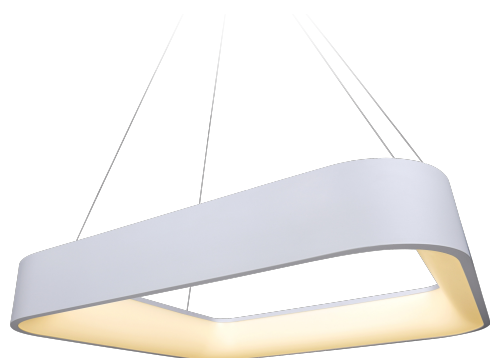

- Available from 14" to 32"
- Lumens from 1,050LM to 3,500LM
- Low profile housing 3.5" height
- Extruded aluminum housing
- 90+ CRI
- Suspended & surface mount



WHITE



BLACK



CUSTOM



ORDERING GUIDE Example: EPLS-2436-40K-U-DM-90-WH-WH-SW

MODEL	SIZE/LUMENS	COLOUR TEMP.	VOLTAGE	DIMMING	CRI	FINISH	CANOPY FINISH
EPLS	1415 14" 1,050LM	27K 2700K	U 120V-277V	DM 0-10V	90 90+ CRI	WH White	WH White
	1725 17" 1,750LM	30K 3000K	UEB 120V-277V W/ Emergency Backup			BK Black	BK Black
	2436 24" 2,520LM	35K 3500K				Custom Specify Ral#	Custom Specify Ral#
	3180 32" 3,500LM	40K 4000K				Example: GR Grey (RAL#9006)	Example: GR Grey (RAL#9006)

MOUNTING OPTION

- SW**
Suspended wire
- SC**
Suspended canopy
- SM**
Surface mount

Suspended Cable Length
ST- Standard 5ft (60" 1500mm)

Suspended Power Cable Length
ST- Standard 5ft (60" 1500mm)

Surface Mount Power Cable Length
ST- Standard 1ft (11.8" 300mm)

*Phase dimming Triac/ELV: Available
Please contact manufacture

Eclipse Square

Architectural Surface / Suspended Luminaire



SPECIFICATION

Construction

Extruded aluminum housing
Polycarbonate lens

Beam Angle

140°

Environment

Suitable for dry or damp locations
Indoor use only
-20°C to 40°C (-4°F to 104°F)

Electrical

0-10V dimming: 100%-10%
Power factor >0.9
Integral Driver or Remote Driver

Emergency Battery

Optional Emergency output
5 watts for 90 minutes

Certificates

ETL and cETL.
Rated Lifetime of L70 50,000+ hrs

LED System

Available in 2700K, 3000K, 3500K, 4000K
CRI 90+
Sustainable LED modules

Finish

Standard: Polyester powder coat white,
black or custom finish (Specify RAL#)
Example: Grey RAL#9006

Warranty

5 year limited parts warranty

DIMENSIONS

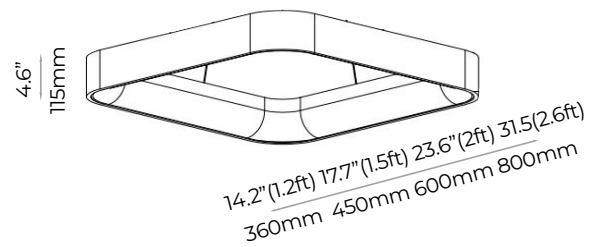
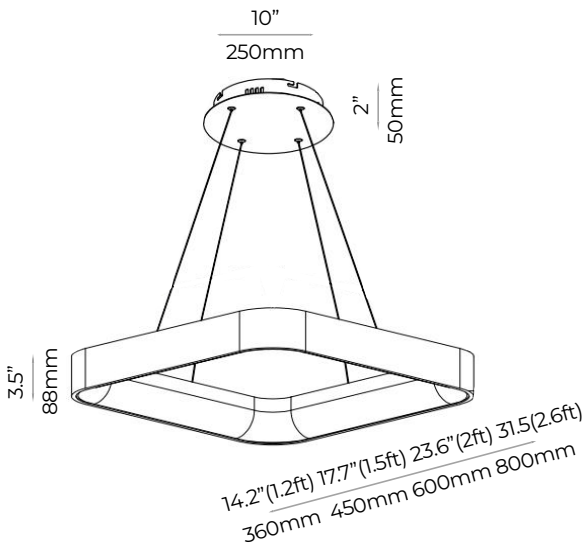

MOUNTING OPTIONS



SW
Suspended wire

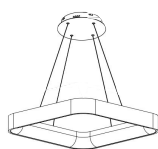

SC
Suspended canopy

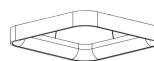

SM
Surface mount

Eclipse Square

Architectural Surface / Suspended Luminaire



TECHNICAL INFORMATION

Suspended

Model	Fixture Dimension (L x H)		Total		# of Sections	Canopy Diameter (Suspended)	
	feet	inch	Lumens	Wattage		inch	mm
1415	1.2ft	14.2 x 3.5	1,050	15	1	9.8	250
1725	1.5ft	17.7 x 3.5	1,750	25	1	9.8	250
2436	2ft	23.6 x 3.5	2,520	36	1	9.8	250
3180	2.6ft	31.5 x 3.5	3,500	50	1	9.8	250

Surface Mount

Model	Fixture Dimension (L x H)		Total		# of Sections
	feet	inch	Lumens	Wattage	
1415	1.2ft	14.2 x 4.6	1,050	15	1
1725	1.5ft	17.7 x 4.6	1,750	25	1
2436	2ft	23.6 x 4.6	2,520	36	1
3180	2.6ft	31.5 x 4.6	3,500	50	1

DISTRIBUTION & OPTICAL

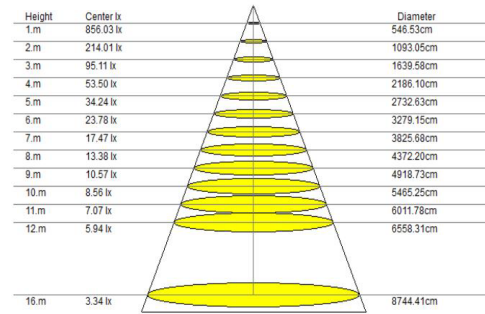
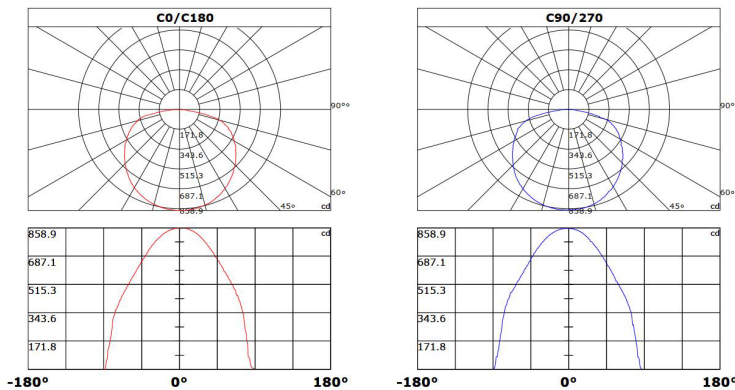

Beam Angle:139.80°(50%Imax)