

# AYRON SERIES

TODAY'S DIGITAL INTELLIGENCE  
MOVES YOUR GATE



# WHAT WE DO

**INNOVATION, TOP NOTCH MECHANICS AND NEVER-ENDING TECHNOLOGICAL RESEARCH ARE THE ELEMENTS THAT MAKE ROGER TECHNOLOGY A UNIQUE AND DIFFERENT COMPANY**

Starting from our first day of work we immediately gave priority to the development and production of excellent, completely Italian mechanics, based only on top quality ferrous and non ferrous raw materials and guaranteed by impeccable production and surface treatment processes. It was just a few years later, in the 1990s, that we created the first major step in our history, by implementing a mass production line for completely robotised motors, thus becoming a reference outsourcer for major brands of the gate automation market.

## PEOPLE, IDEAS AND PRODUCT EXPERIENCE

From the very beginning Roger Technology has evolved and grown because it's people believe that any bright idea can lead to great change in the future. Our people are passionate and innovative in their approach to every challenge, always pushing the boundaries to develop extraordinary products.

In our language we translate the word "experience" as passion. It is this passion that drives us in the development of revolutionary **new products** that serve the real needs of our customers. We understand that our customers want a product designed around the way that they work.

*Primo Florian  
Founding partner  
Engineering  
and design*

*Dino Florian  
Founding President  
Development  
and design*

*Renato Florian  
Founding partner  
Assembly  
and quality*



# OUR PLUSES

## EXCELLENT RAW MATERIALS

Steel, ductile cast iron, aluminium, bronze, copper and titanium have always been the main and exclusive raw materials used in the advanced engineering processes of our company.



## PRODUCTION TECHNOLOGY

At Roger Technology all internal manufacturing is carried out on optimised production lines making use of very advanced technology. We have invested heavily in robotics and automated all product manufacturing phases. This ensures that all components and semi-finished products are highly reliable and are fully compliant with our exceptionally high quality standards.



## INTERNAL ASSEMBLY

Our highly qualified and dedicated staff oversee the fitting and assembly stages. Every piece of equipment is checked by our all italian personnel to ensure that we deliver reliable products to our customers.



## MADE IN ITALY

All solutions, products, design and the complete production process of Roger Technology is developed in Italy with the use of materials of primary quality always found in the market trough partner suppliers that share the same passion and professionalism of our company in developing products technologically reliable, efficient and simple in the way that they have been made for being installed and used.



# BRUSHLESS MOTOR

**A DIGITAL BRUSHLESS MOTOR WITH PERMANENT MAGNETIC FIELD, DIGITAL ELECTRONICS FOR THE COMPLETE MANAGEMENT OF THE AUTOMATION SYSTEM CONTROL. DESIGNED FOR SUPER INTENSIVE USE WITH THE ADDED BENEFIT OF A SUPER LOW POWER CONSUMPTION: THIS IS ROGER BRUSHLESS**

We are the creators at the heart of the product!  
All of our digital brushless motors are designed and manufactured in our own factories. Using dedicated automated machines the motors are wound with ultimate precision.

## DIGITAL BRUSHLESS MOTOR

Revolutionary and innovative digital Brushless motor with permanent magnetic field, three-phase sinusoidal power supply with native encoder that allows super-intensive use of the automation system with extremely low power consumption, not only providing 100% compliance with all the automation system management and safety rules, but setting new standards in gate safety.

## NEW GENERATION OF ELECTRONICS

The new control unit with onboard digital Brushless controller. Without traditional relays and due to the revolutionary MOSFET quadrant system and its control technology entirely based on a DSP (Digital Signal Processor) microcontroller, it represents a new generation of electronic cards created to safely handle all movement phases of the automation system.

## ENGINEERING PASSION

All the mechanical components and gears are manufactured in steel, cast iron and bronze. The automation system casings are made from titanium-reinforced die-cast aluminium. All the gears are inspected and assembled on high-quality bearings and inserted on precise seats machined to provide absolute precision between the axes.

**A TECHNOLOGY THAT OFFERS MAXIMUM PERFORMANCE BUT CONSUMES LESS POWER THAN OTHER MOTORS**

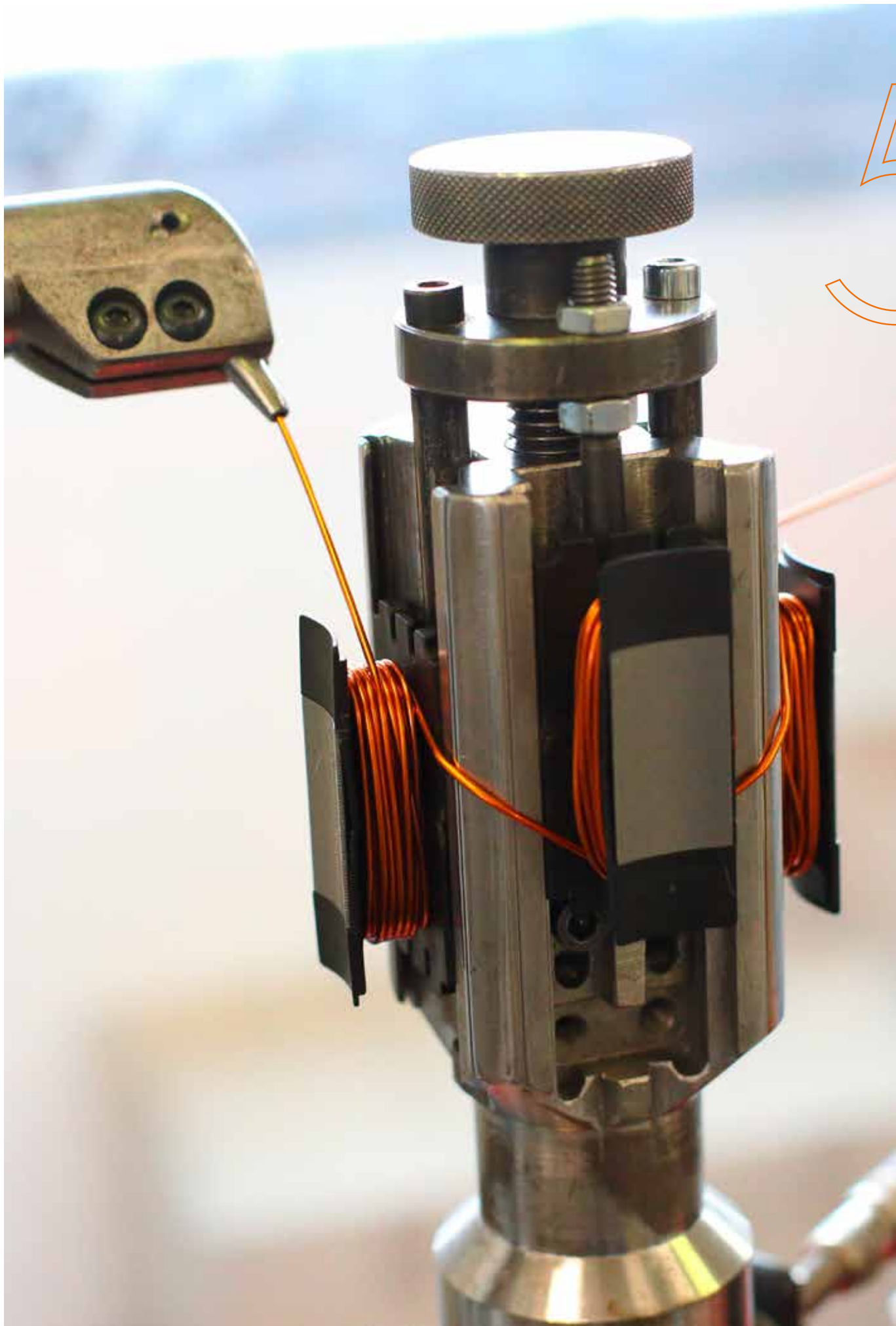

5

# COMPLETELY BRUSHLESS

## THE REVOLUTIONARY DIGITAL MOTOR WITH 12 UNIQUE FEATURES



### 3-PHASE DIGITAL BRUSHLESS MOTOR

A very powerful motor with substantial torque. The motor is compact and neat due to the special concentrated coil windings, it is powered by a **three phase sinusoidal system**.



### NO PROBLEM IN THE EVENT OF POWER FAILURE

With the help of internal or external batteries and the associated battery charging card, your automation system continues to operate for a considerable time **even during prolonged power cuts**, ensuring many more operations than traditional technologies.



### SPEED, ACCELERATION AND DECELERATION WITH EXTREME ELEGANCE

The automation system with brushless digital technology creates perfect and elegant movements. With a constant **force and torque** at every point and with the option of varying the speed on deceleration and acceleration the system can be managed with maximum safety.



### EXTREMELY LOW ENERGY CONSUMPTION

A motor that can operate at low voltage in super-intensive use and which can operate in environments with extremely demanding weather conditions while maintaining **very low energy consumption and absorption levels**.



### DIGITAL AND VECTORIAL AUTOMATION CONTROLLER

The BRUSHLESS digital controller, which operates at low voltage **24V DC**, allows 100% control of the automation system in digital mode. Due to its operation entirely based on a DSP microcontroller the travel and all the movements of your automation system can therefore be programmed and customised easily, precisely and elegantly.



### MOTOR AT AMBIENT TEMPERATURE

The brushless motor was created with the main goal of being a motor for super intensive use and **with a 99% efficiency**. Regardless of how many operations the engine performs in a day, it always remains cold or at the most reaches the outside ambient temperature.



### THE DIGITAL SILENCE OF THE MOTOR

One great impact is the **silence** or the near absence of noise, generated by the BRUSHLESS motor during all its movements.



### MOTOR FOR SUPER-INTENSIVE USE

We wanted to surprise our customers with a product that was fundamentally different to any other product on the market. Fact: our motor remains **permanently cold** even after many days of super intensive use.



### IMPACT, OBSTACLE DETECTION AND REVERSAL IN TOTAL SAFETY

Thanks to digital technology we are able to **detect an obstacle** and reverse the motor instantly, by simply specifying the torque of the motor, the sensitivity, the time and the travel of the reversal. All in full compliance with safety requirements.



### ONBOARD NATIVE DIGITAL ENCODER

The BRUSHLESS motor has a highly advanced **native digital encoder** that controls management of automation systems in a safe, precise and extremely elegant manner.



### SIMPLE INSTALLATION WITH A SINGLE 3-WIRE CABLE

The BRUSHLESS motor can be installed by simply connecting it using three wires! What could be easier? This will provide full digital management of your automation system thanks to the **SENSELESS** and **SENSORED** (absolute encoder) technology incorporated in the BRUSHLESS sliding gate motors.



### ADVANCED PRECISION ENGINEERING TO OBTAIN OPTIMAL MOTOR PERFORMANCE

We have created a mechanism that gives you the opportunity to get **the maximum performance out of the motor**. A product which combines the quality of the internal production processes, the mechanical processing and the use of high quality ferrous and non-ferrous materials.

# WHY BRUSHLESS?

DIGITAL, SMART, POWERFUL, ELEGANT, ROBUST AND ALL-ITALIAN





## 1 MASTER MOTOR WITH INTEGRATED DIGITAL CONTROLLER

The new Ayrón articulated arm motor offers you the new Brushless Digital Brushless B70/2ML 24V DC controller, fully integrated and very compact in shape. It is positioned inside the master version to have total control in safety and elegance of the motor even in High Speed mode.

## 2 SLAVE MOTOR WITH INTEGRATED BATTERY HOUSING

The new Ayrón offers you the possibility of housing directly inside the engine in the slave version the backup battery pack composed of two batteries from 12V AC to 1.2 A/h.

## 3 ARTICULATED STEEL ARM

Ayrón offers the possibility to automate the swing motor with articulated arms in the short, long and telescopic version. All thanks to the use of top quality steel with thicknesses designed to last over time.

## 4 VERY HIGH PRECISION MECHANICS

The internal mechanics of the Ayrón is completely developed with high quality ferrous materials. It is impeccable in its movements thanks to gears designed to manage the motor at high speed and intensive use.

## 5 INTERNAL AND EXTERNAL MANUAL RELEASE LEVER

Ayrón offers, in a fully integrated way, two release modes, one internal lever operated and one external cord operated. It is designed to guarantee the unlocking of the automation internally and externally in the event of a blackout.

## 6 COLUMN FIXING BRACKET

Ayrón is fastened to the column by designing a 5 mm thick bent steel bracket, which makes it possible to use the minimum fixing distance of 90 mm on the column.

## 7 BRUSHLESS DIGITAL MOTOR

Digital Brushless motor based on a permanent magnetic field which uses neodymium iron-boron magnets inside the rotor. With innovative high density coil windings powered by a sinusoid three-phase power system, the motor of the Ayrón is powered by low voltage (24V DC). The motor is extremely compact and operates at normal ambient temperature, making it suitable for extremely intense use and extraordinarily energy efficient.

## 8 ADJUSTABLE CROWN LIMIT SWITCH

Ayrón's opening and closing position is adjusted by mechanical multi-position limit switches, which are fixed directly into the plate in an adjustable crown system.

## 9 INTEGRATED BATTERY CHARGER CARD PREDISPOSITION

The Master and Slave communication of the Ayrón motor allows the 24V DC battery charger board to be housed in an extremely compact way, directly supplying the two batteries housed in the Slave motor.

## 10 INTEGRATED B-CONNECT IP PLUG

The integrated digital controller B70/2ML mounts the new B-CONNECT IP technology to have total control of the controller through a web page wherever you are.

## 11 PROTECTIVE COVER WITH KEY







The Master and Slave versions of the Ayrón engine consist of a double protective cover that gives access to the electronics through a key cylinder, with external weatherproof entry.

## 12 DSP DIGITAL INVERTER CONTROL

The digital controller develops its total task in maximum efficiency and safety through the revolutionary, highly efficient Mosfet Compact quadrant digital inverter. It allows the management of the door with different speeds and with total control of the power and sensitivity in case of obstacle detection.



# TECHNICAL SPECIFICATIONS

	AY/250/M	AY/250/S
<b>DESCRIPTION</b>	Electromechanical motor BRUSHLESS HIGH SPEED, low voltage, super intensive use, with native encoder onboard, irreversible, ideal for swing gates with leaf up to 2,5 mt lenght, with mechanical stopper in opening and closing. Complete with digital controller on board, without articulated arms.	Electromechanical motor BRUSHLESS HIGH SPEED, low voltage, super intensive use, with native encoder onboard, irreversible, ideal for swing gates with leaf up to 2,5 mt lenght, with mechanical stopper in opening and closing. Without digital controller, without articulated arms.
	 	 
POWER LINE SUPPLY	230V AC - 50Hz	230V AC - 50Hz (from motor AY/250/M)
MOTOR POWER SUPPLY	24V DC	24V DC
POWER RATING	160W	160W
FREQUENCY OF USE	Intensive use	 Intensive use 
THRUST	50 - 200N	50 - 200N
OPERATING TEMPERATURE	-20 C° +55 C°	-20 C° +55 C°
PROTECTION LEVEL	IP43	IP43
REDUCTOR TYPE	Irreversible	Irreversible
SPEED	4 - 1,5 Rpm	4 - 1,5 Rpm
OPENING TIME AT 90°	10-18 s	10-18 s
STROKE	350-450 mm	350-450 mm
LIMIT SWITCH	Mechanical stopper in opening and closing	Mechanical stopper in opening and closing
RELEASE SYSTEM	Internal lever or external lever with cord (optional)	Internal lever or external lever with cord (optional)
DIGITAL CONTROLLERS	On board (B70/2ML)	-
ENCODER	Digital native encoder SENSORLESS 48 PPR	Digital native encoder SENSORLESS 48 PPR
OPERATING CYCLES PER DAY (OPENING/CLOSING - 24 HOURS NO STOP)	800	800
BATTERIES RECOVERY	2 external batteries 12V DC 1,2 Amp/h (on external box) - optional	2 internal batteries 12V DC 1.2 Amp/h (inside AY/250/S)
MAXIMUM DIMENSION PRODUCT IN MM (L X W X H)	189 x 245 x 270 (330)	189 x 245 x 270 (330)
PRODUCT WEIGHT PACKED (KG)	13,2	10,1

## KIT PACKAGING

L.: 53,5 cm  
P.: 19,5 cm  
H. 39,2 cm



Brushless Motor



Intensive Use



High Speed Motor



Reversible Motor

# FUNCTIONS

## OF AUTOMATED SWING GATE MOTOR

DESCRIPTION	AY/250/M
<b>MAXIMUM LENGTH OF SINGLE GATE LEAF</b>	<b>UP TO 2.5 METERS</b>
DIGITAL CONTROLLER	B70/2ML
RADIO RECEIVER TYPE	H93/RX20/1 with fixed code connection H93/RX22A/1 with fixed code connection H93/RX2RC/1 with rolling code connection
MOTOR POWER SUPPLY	24V DC
MOTOR POWER CONTROL TECHNOLOGY (ETPC)	Field oriented control (FOC) with SENSORLESS technology
ENCODER TYPE	Digital SENSORLESS, 48 PPR
MAINS POWER SUPPLY	230V 50/60 Hz
BATTERY OPERATION	(optional) 2 internal batteries (in the digital controller box) 12V DC 1.2 Amp/h (optional) 2 external batteries 12V DC 4.5 Amp/h
ENERGY CONSUMPTION	Very low consumption
NUMBER OF MOTORS	1 - 2 motors (AY/250/S)
POWER SUPPLY FOR ACCESSORIES	24V DC
FLASHING LIGHT TYPE	24V DC LED
OUTPUT FOR GATE OPENING INDICATOR AND AUTOMATION SYSTEM ON WARNING LIGHT	✓
OUTPUT FOR COURTESY LIGHT	40W
TIMED AND GUARANTEED AUTOMATIC CLOSING	✓
GATE EDGE SAFETY MANAGEMENT, 8.2K $\Omega$ OR STANDARD	✓
LIMIT SWITCH TYPE	Adjustable open and closed position mechanical travel limits
SEPARATE MANAGEMENT FOR MOTOR 1 - 2	✓
FORCE ADJUSTMENT IN NOMINAL MOVEMENT	✓
FORCE ADJUSTMENT IN START-UP AND DECELERATION	✓
OBSTACLE DETECTION - MOTOR REVERSAL	✓
ADJUSTEMENT IMPACT FORCE SEPARATE MOTOR 2	✓
SPEED ADJUSTMENT	✓
DECELERATION	✓
STARTING ACCELERATION (SOFT-START)	✓
GUARANTEED CLOSING	✓
WIND PROTECTION FUNCTION WITH GATE CLOSED	✓
MOTOR STOPPING DISTANCE AND BRAKING DISTANCE	✓
PARTIAL OPENING CONTROL	Pedestrian entry
HUMAN PRESENCE CONTROL	✓
LOCK MANAGEMENT	✓
CONDOMINIUM FUNCTION	✓
SAFETY DEVICE CONFIGURATION	✓
INSTALLATION TEST FUNCTION	(prog button)
OPERATING TEMPERATURE	-20°C/+55°C
INVERTER THERMAL PROTECTION	✓
CURRENT ABSORPTION MAPPING SYSTEM	(MCA)
RESTORE FACTORY DEFAULT VALUES	✓
INFORMATION ON USE OF MOTOR	✓
B-CONNECT UNIT INPUT ON-BOARD	✓
SECURITY PASSWORD MANAGEMENT	✓

# INSTALLATION

## DIMENSIONS

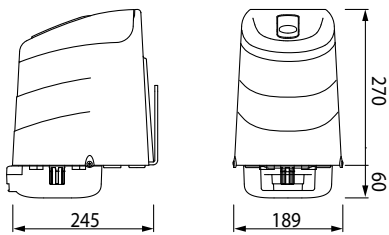

Note: all measurements in the drawings are in millimetres

## OPERATING LIMITS

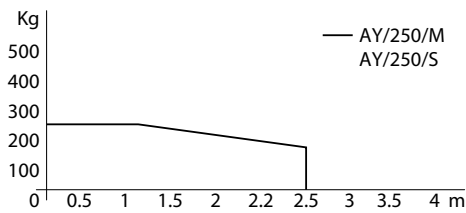

## PREPARATIONS FOR STANDARD INSTALLATION

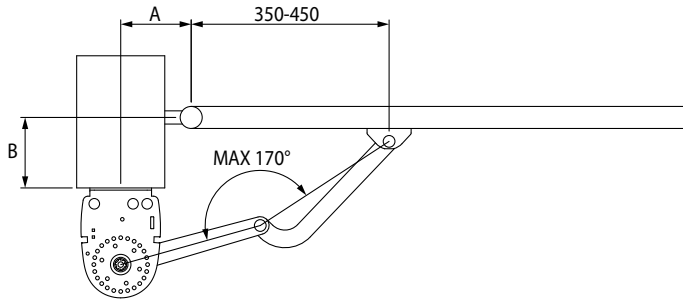

### AYRON

A	B	$\alpha^\circ$
130	50-120	90°
140	120	90°
150	50	95°
180	180-200	95°-100°
200	200	100°
250	250	105°

# KIT

## KIT AY/255

For swing gates up to 2,5 m

## CONTENTS OF STANDARD AYRON SWING GATE MOTOR KIT

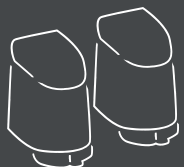

1 articulated swing motor (Master) with control unit on board

1 articulated swing motor (Slave)



2 short articulated steel arms



1 radio receiver with 2 fixed code channels, H93 series



2 fixed code remote control units with copying function, Synus series



1 pair of photocells, R90 series



24V DC LED flashing lamp unit with integrated antenna



1 "Automatic Opening" warning notice

The composition of the kit is subject to change in the nature or quantity of the items. For the correct content of the kits always refer to the catalogue, the current sales price lists or the online product catalogue at

[WWW.ROGERTECHNOLOGY.COM](http://WWW.ROGERTECHNOLOGY.COM)



# OPTIONAL ACCESSORIES

AYRON: EVERYTHING YOU NEED FOR A COMPLETE, PROFESSIONAL INSTALLATION

	<b>LT336</b>	Arms short for articulated AY series		<b>RL673</b>	External manual release kit without handle AY series
	<b>LT337</b>	Arms long for articulated AY series		<b>R99/C/001</b>	"Automatic Opening" warning notice

# STANDARD ACCESSORIES

Accessories included in the kit

			<b>KIT AY/255</b>	<b>AY/250/M</b>	<b>AY/250/S</b>
	<b>LT336</b>	Arms short for articulated AY series	✓ <b>2PC</b>		
	<b>KT249</b>	Column mounting plate for AY series	✓ <b>2PC</b>	✓	✓
	<b>KT218</b>	Gate pull bracket for series articulated	✓ <b>2PC</b>	✓	✓

# STANDARD INSTALLATION

A PRACTICAL EXAMPLE FOR YOUR SUCCESSFUL INSTALLATION

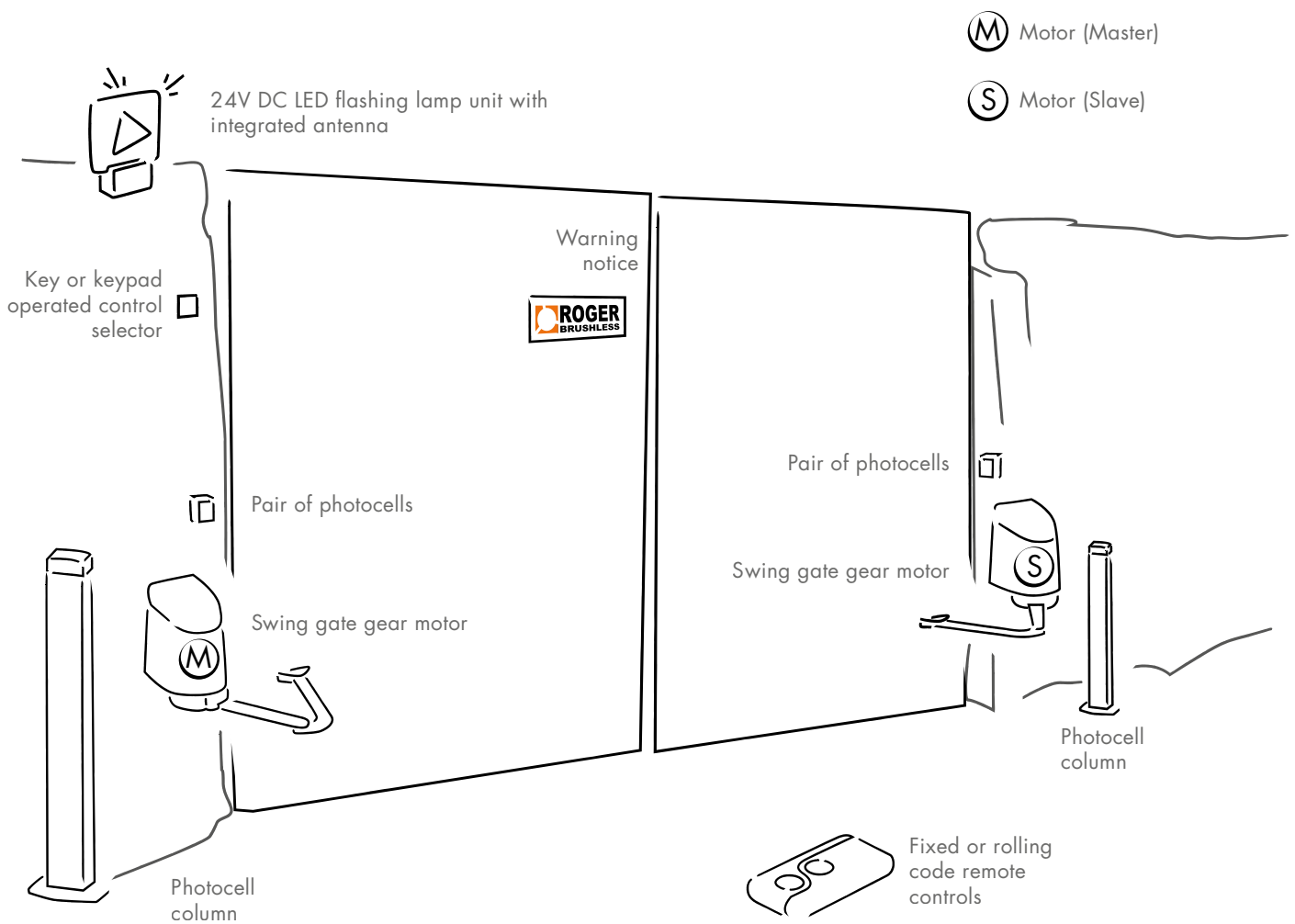

# MASTER/SLAVE CONCEPT

## MASTER MOTOR



1 swing motor with  
central on board



## SLAVE MOTOR



1 swing motor with  
battery compartment

## AYRON SOLUTION

The Ayrón motor has the particularity of having an electromechanical gear motor complete with digital controller on board (**MASTER - B70/2ML**) and another one without digital controller (**SLAVE**)



SWING  
GATE



PREMIUM DEALER / PROFESSIONAL DEALER



100% Made in Italy

Via S. Botticelli, 8  
31021 Bonisiolo di Mogliano Veneto (TV) · ITALY  
T. +39 041 5937023 · F. +39 041 5937024

[WWW.ROGERTECHNOLOGY.COM](http://WWW.ROGERTECHNOLOGY.COM)



[WWW.WEAREBRUSHLESS.COM](http://WWW.WEAREBRUSHLESS.COM)