





iScooter



**iScooter**  
iX6

### **Customer Service**

Our friendly customer service team will work hard to put a smile back on your face. Here's how we can connect:

-  Lifetime technical support
-  [www.iscooterglobal.com](http://www.iscooterglobal.com)
-  [www.facebook.com/iScooterGlobal](https://www.facebook.com/iScooterGlobal)
-  [support@iscooterglobal.com](mailto:support@iscooterglobal.com)

**Thank you so much for your support.**



# Contents

1. Package Contents	01
2. Product Overview	02
3. Control Panel	03
4. Assembly	05
5. Riding Notice	06
6. Charging	06
7. First Ride	07
8. Riding Basics	08
9. Safety Instructions	09
10. Dangerous Actions (No Attempting!)	10
11. Disc Brake Adjustment	12
12. Daily Care and Maintenance	13
13. Specifications	14
14. Limited Warranty Statement	15
15. Question & Answer	17
16. Contact Us	18



## Package Contents

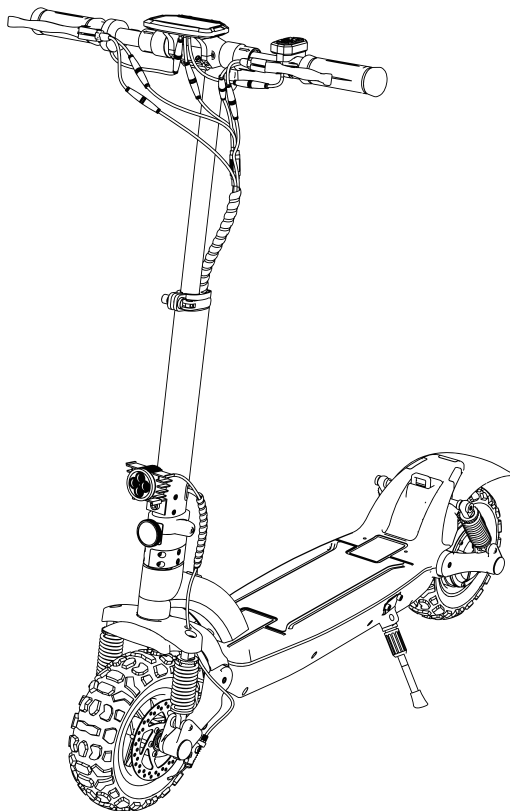

- When unboxing your iX6 electric scooter, please verify that the below items are included in the package. If anything is missing or damaged, please contact iscooter customer service for support: [support@iscooterglobal.com](mailto:support@iscooterglobal.com)
- Keep the package box to ship back the scooter when necessary.

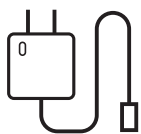

1 x Charger

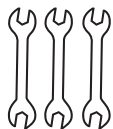

3 x Tool



6 x Tool



1 x Car Bag

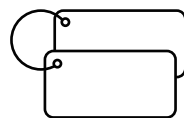

2 x NFC



# Product Overview

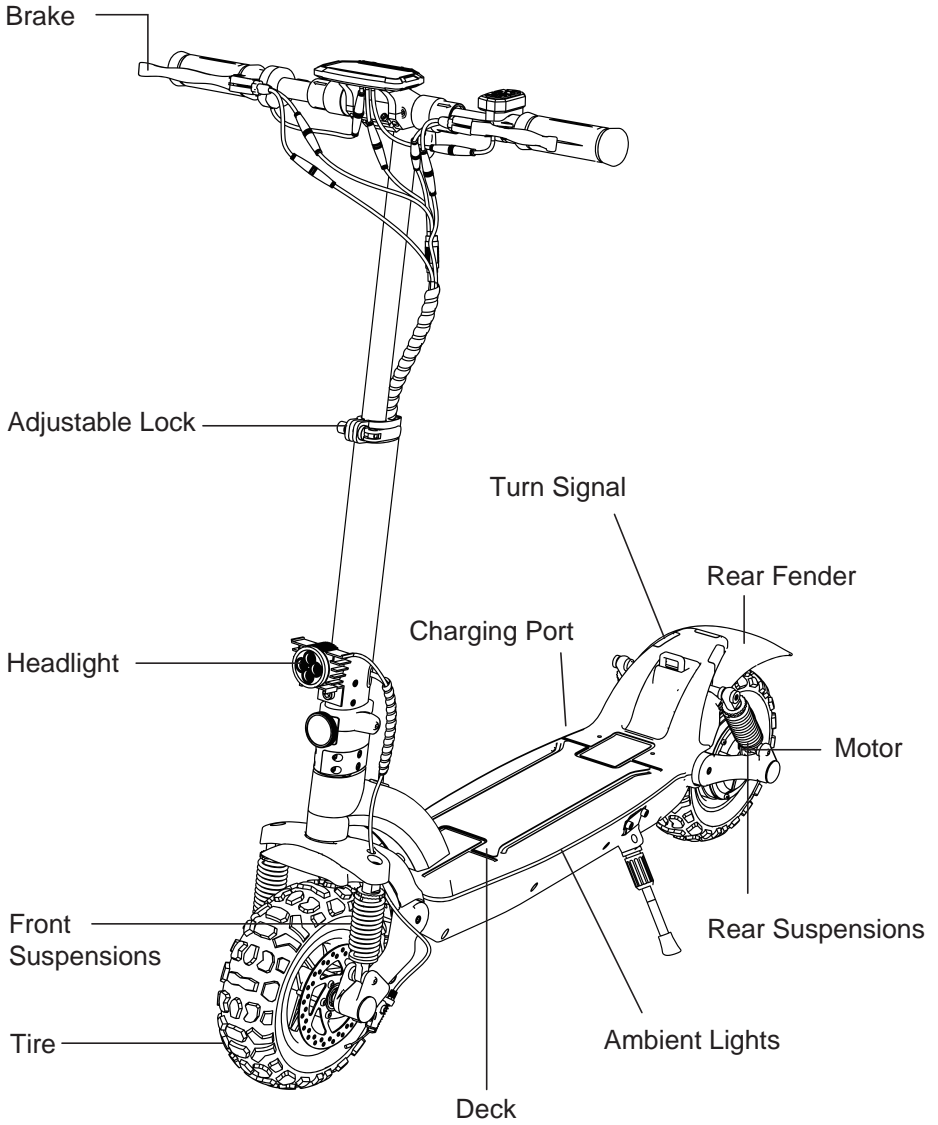



# Control Panel

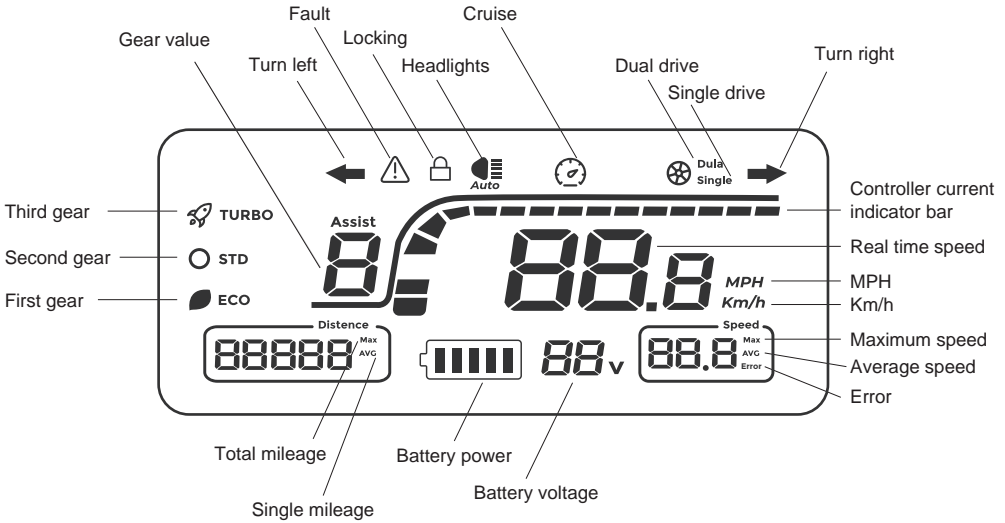

## Displayed Content

Speed	Distance riding per hour.		
Riding Mode	Three riding modes, after power on, press +/- key to switch between ECO, STD, and TURBO modes.		
	ECO: First gear 	STD: Second gear 	TURBO: Third gear 
Battery Level	5-bar battery level.		

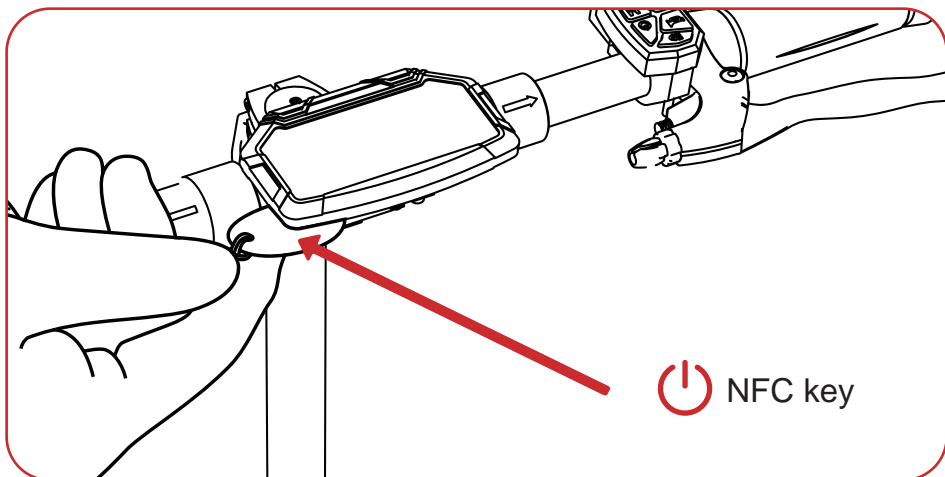

## Mode settings:

After turning on the scooter, press and hold 'M' and 'Light' buttons for about 10 seconds. Release the 'Light' button first, then release 'M' button to enter setting mode.

P01: Kilometer/mile selection setting

P02: Voltage level setting: 36V/48V/60V/72V; the default is 48V, and the undervoltage value is automatically adjusted when the voltage is selected (this item is not recommended to be adjusted)

P03: Wheel diameter: unit, inch; 8.0-12.0, default 10, increases by 0.5 for each change (this item is not recommended to be adjusted)

P04: Number of magnetic poles for speed measurement: range: 1-100, default 30 (default value is ideal) (this item is not recommended to be adjusted)

P05: Cruise selection: 0 means cruise off, 1 means cruise on; after the cruise is turned on, the cruise icon appears on the display

P06: Zero start/non-zero start setting, 0: zero start; 1: non-zero start

P07: Top speed setting 10%-100%; 00 means 100%

P08: Sleep time setting: 0, sleep off; other numbers are sleep time, range: 1-30; default 5 minutes

P09: Backlight brightness adjustment: Level 1 is the darkest, Level 3 is the brightest

P99: Restore factory default parameters; press and hold the + button for 5 seconds during P99

ODO: Travel distance reset; long press the + button for 5 seconds at ODO



## Assembly

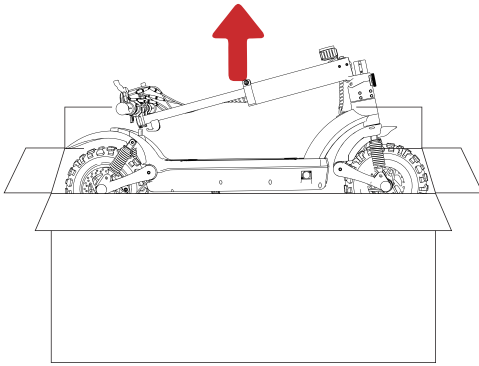

1. Open the package, take out the E-scooter and its accessories.

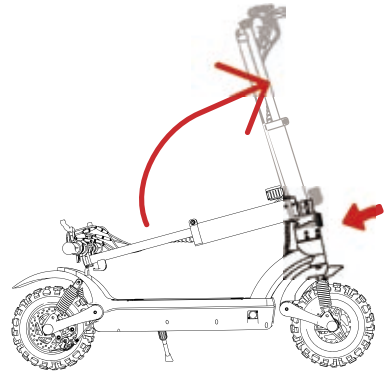

2. Press the folding mechanism and lift the T-bar upright. Push down the kickstand.

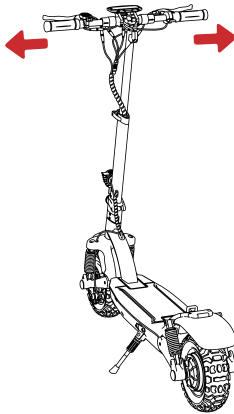

3. Cut the tapes on the handlebar. Lift the handlebars on both sides up and slide in to secure. (Tips: Don't tighten only one side one time, visit [www.iscooter.com](http://www.iscooter.com) for additional help with assembly, including a step-by-step video.)

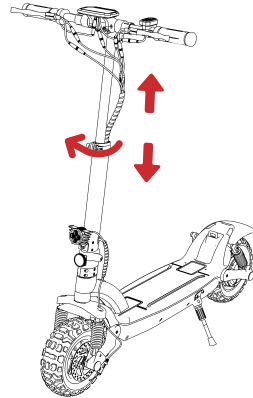

4. Open the adjustable lock, adjust the handlebar to the height you needed, then close the lock.



## Riding Notice

The scooter iX6 electric scooter is a leisure device. But once they're in a public area, they'll be seen as vehicles, subjecting to any risks faced by vehicles. For your safety, please follow instructions in the manual and traffic laws and regulations set forth by government and regulatory agencies.

- At the same time, you should understand that risks cannot be entirely avoided as others may violate traffic regulations and drive incautiously, and you're exposed to road accidents just as when you're walking or biking. The faster the scooter is, the longer it takes to stop. On a smooth surface, the scooter may slip, lose balance, and even result in a fall. Thus it is crucial that you use caution, keep proper speed and distance, especially so when you're unfamiliar with the place.
- Respect pedestrians' Right of Way. Try not to startle them while driving, especially children. When you ride from behind pedestrians, ring your bell to give them a heads-up and slow your scooter to pass from their left (applicable to countries where vehicles drive on the right). When you ride across pedestrians, keep to the right at a low speed. When you drive across pedestrians, keep the lowest speed or getting off the vehicle.
- Closely follow the safety instructions in the manual. iscooter shall not be liable for any financial losses, physical injuries, accidents, legal disputes and other interest conflicts resulted from actions that violate user instructions.
- Do not lend your scooter to whoever doesn't know the operations. And when you do lend it to your friends, please take the responsibility to ensure he/she knows the operation and wears the safety gear.
- Check the scooter before every use. When you note loosen parts, low battery alerts, excessive wear, strange sounds, malfunctions and other abnormal conditions, stop riding.
- WARNING – Risk of Fire – No User Serviceable Parts.



## Charging

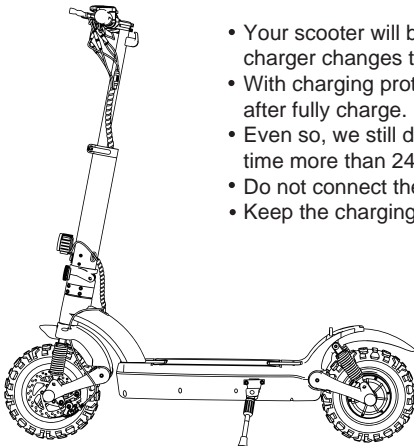

- Your scooter will be fully charged when the LED indicator on the charger changes to green from red.
- With charging protection, it will cut off charging automatically after fully charge.
- Even so, we still don't recommend charging your scooter for a long time more than 24 hours at one time.
- Do not connect the charger if the charging port is wet.
- Keep the charging port closed when not charging.

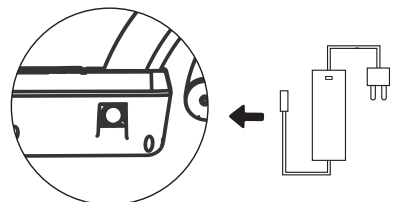





### Power Switch

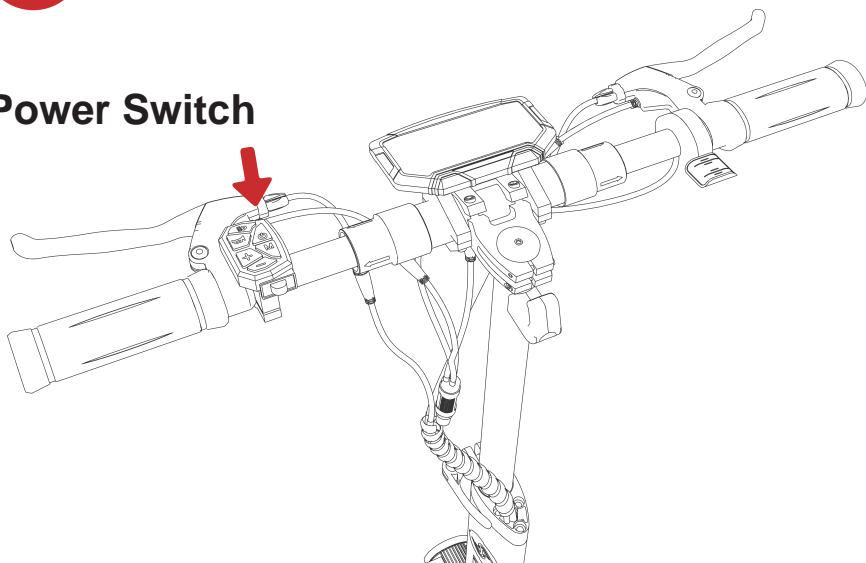

1. Press the power switch for 1-3 seconds and then release, LCD display is on — it means the electric scooter is successful turned on.



2. Press the headlight button after power on to turn on the headlight and the ambient light on the deck.



3. Zero start: after power-on, press the accelerator and the motor of the scooter will rotate, and the scooter will go forward. (The throttle works even when the E-scooter is not in motion.)



4. Non-zero/Kick-and-go start: With kick-and-go start mode on, scoot the E-scooter for the throttle to operate.



5. Riding mode: After power on, press +/- key to switch between ECO, STD, and TURBO modes. (The default mode is low-speed ECO at first power-on.)



6.1 Comfort mode: the speed is 10km/h in 1st gear, 15km/h in 2nd gear, 25km/h in 3rd gear  
6.2 Off-road mode: the speed is 15km/h in 1st gear, 30km/h in 2nd gear, 45km/h in 3rd gear

Mode switching: Short press the m key five times continuously after power on, the meter displays 45km/h, indicating that the setting is successful. Switch comfort mode: After restarting the scooter again, short press the M button five times in a row, and the meter displays 25km/h, indicating that the setting is successful.



## Riding Basics

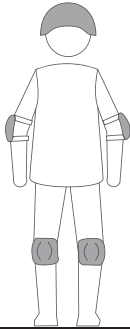

**⚠** Wear a helmet, elbow pads, and knee pads in case of falls and injuries either you are a beginner learning to ride or you are a seasoned rider.

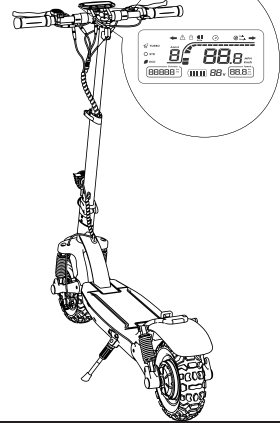

1. Turn the power on, and check the battery level indicator.

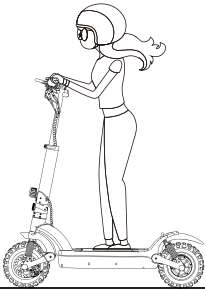

2. Stand with one foot on the deck and one foot on the ground. Scoot yourself with the foot on the ground.

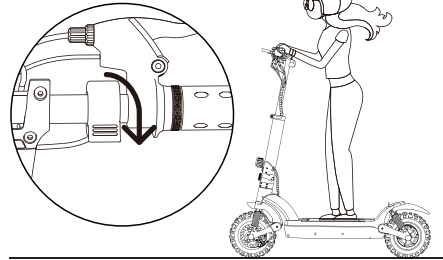

3. When the scooter starts to move forward, put both feet on the deck and press the accelerator. (The accelerator initiates once the speed exceeds 3 mph.)

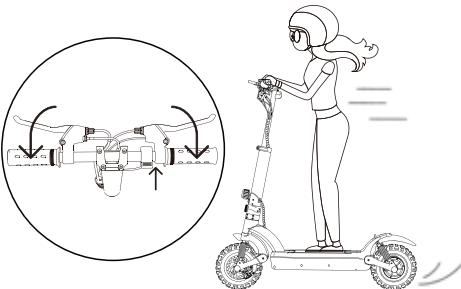

4. Release the accelerator and the kinetic energy recovery system (KERS) initiates automatically to brake slowly; And squeeze the brake lever for a sudden brake.

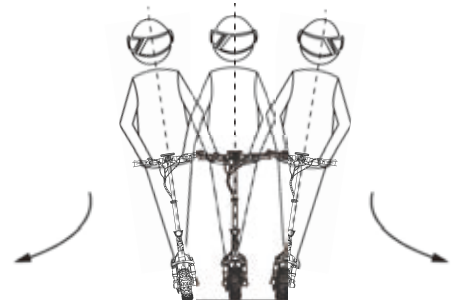

5. Tilt your body to the steering direction as you turn, and slowly turn the handlebar.



## Safety Instructions



Do not ride in the rain.

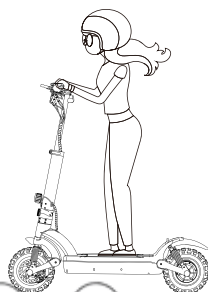

Please keep a medium or low speed (5mph) when you ride across speed bumps, elevator door sills, bumpy roads or other uneven surfaces. Slightly bend your knee to better adjust mentioned surfaces.

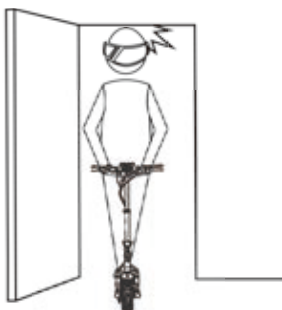

Look out for doors, elevators and other overhead obstacles.

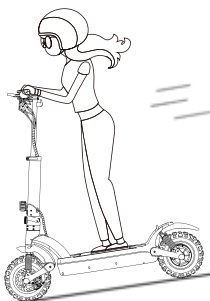

Do not accelerate when you go downhill.



Do not press the accelerator when you're walking alongside the scooter.



Always steer clear of obstacles.



Do not hang bags or other heavy stuff on the handlebar.

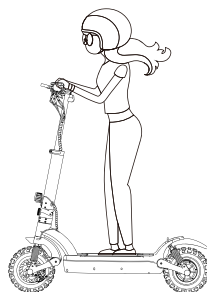

Keep both feet on the deck all time.



## Dangerous Actions (No Attempting!)



Do not ride in traffic lanes or residential areas where vehicles and pedestrians are both allowed.

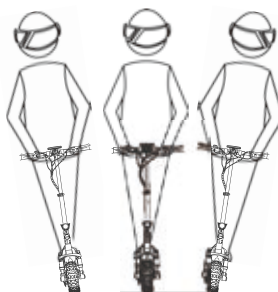

Do not turn the handlebar violently during high-speed riding.



Do not ride in a ponding that is higher than 20mm.

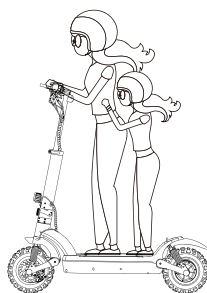

Do not ride with anyone else, including children.

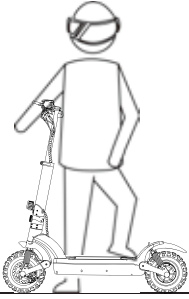

Keep your feet off the rear mudguard.

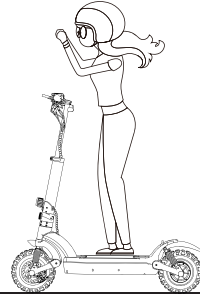

Always keep your hands on the handlebar.



Do not touch the disc brake.

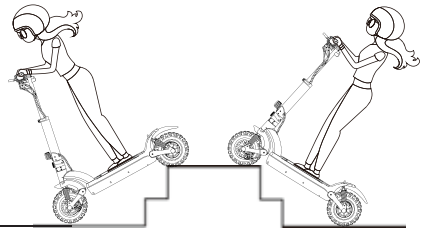

Do not try riding up or down stairs, and jumping over obstacles.



## Disc Brake Adjustment

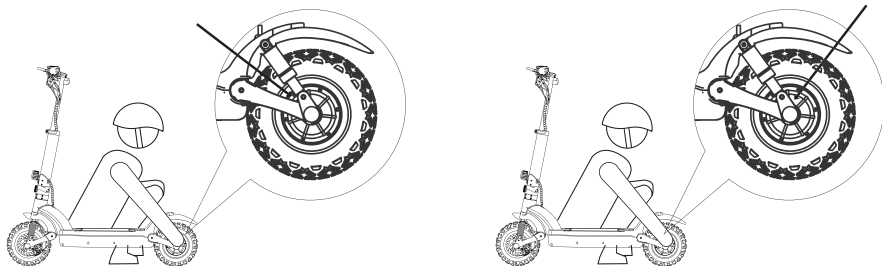

### To adjust the disc brake sensitivity:

You need a hex wrench to remove the screws on the rocker.

- When the disc brake is too sensitive, rotate the disc brake rocker down a bit. Then, reinstall the screws back to the brake cable core to tighten.
  - When the disc brake cannot stop, rotate the disc brake rocker up a bit. Then, reinstall the screw back to the brake cable core to tighten.
- Notice: The disc brake may squeak when in use until it is broken in. This is normal and does not affect the brake's function or performance.

### To remove the disc brake noise:

First make sure the scooter is turned off. For easier operating, we suggest you put the scooter on the desk.

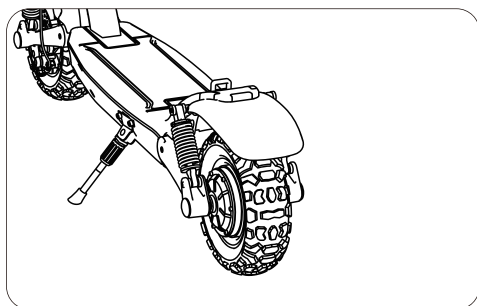

- Loosen two screws on the pump (not the screw on the rocker).
- Adjust the position of the disc brake pump to ensure that the brake disc is in the middle of the two brake pads.
- Keep the brake disc and brake pad not touching each other.
- Hold the disk brake pump in the desired position, then re-tighten the screws to the pump.



## Daily Care and Maintenance

### Cleaning and Storage

If you see stains on the scooter's body, wipe them off with a damp cloth. If you cannot scrub off the stain, put on some toothpaste, and brush them with a toothbrush, then wipe them off with a damp cloth.

Notes:

- Do not clean the scooter with alcohol, gasoline, kerosene, or other corrosive and volatile chemical solvents to prevent dire damage.
- Do not wash the deck with a high-pressure water spray. During cleaning, make sure that the scooter's turned off, the charging cable is unplugged, and the rubber flap is closed as water leakage may result in electric shock or other major problems. When the scooter is not in use, keep it indoors where it is dry and cool.
- Do not put it outdoors for a long time. Excessive sunlight, overheating, and over-cooling will shorten the battery pack's lifespan.

### Battery Maintenance

1. Use original battery packs. Use of batteries of other models or brands may bring about safety issues,
2. Do not touch the contacts. Do not dismantle or puncture the casing. Keep the contacts away from metal objects to prevent short circuit which may result in battery damage or even injuries and deaths,
3. Use original power adapter to avoid potential damage or fire,
4. Mishandling of used batteries may do tremendous harm to the environment. To protect natural environment, please follow local regulations to properly dispose used batteries.
5. After every use, fully charge the battery to prolong its lifespan.

### Storage and Disposal

1. Please try to store the scooter in a cool and dry place between 14 °F and 104 °F . In extremely humid environments the interior of the scooter may suffer condensation or even water accumulation, which may damage the battery rapidly. Devices are not intended for use at elevations greater than 2000 m above sea level. Prolonged Exposure to UV Rays, Rain and the Elements May Damage the Enclosure Materials, Store Indoors When Not in Use.
2. In daily use, try to recharge the scooter after completely exhausting the battery. If the battery level is low, charge it as soon as possible.
3. Please charge the scooter every other month to preserve the battery.



## Specifications

iX6	Item	Electric Scooter
Dimensions	Unfolded (Length. x Width x Height)	122*63*125 cm
	Folded (Length. x Width x Height)	122*22*57 cm
Weight	Net Weight	53LB / 24.3KG
	Load	150 kg
User	Recommended Age	14+
	Recommended Height	120~200cm
	Speed	25-45 km/h
Scooter	Long Range	40-45 km
	Max. Slope	35%
	Operating Temperature	-15°C~40°C
	Protection level	IPX4
Battery	Voltage	48 V
	Max.Charging Voltage	54.6 V
	Capacity	17.5 AH
Motor	Power	1000 W
	Input Voltage	110-240 V
Charger	Output Voltage	54.6 V
	Output Current	2A
	Charging Time	<u>9</u> 7-9 h

(1) The height of the body: Distance from the ground to the highest end of the body.

(2) Description of the battery life: It is measured under the condition of full charge, a load of 70KG, at 25°C, on a flat road without wind, and at a speed of 15KM/H. The real battery life will differ with different factors of the load, humidity, wind speed and operation habits.

(3) The maximum allowable weight shall be kept within 150KG (driver and objects included) in any case. Consider an extra weight of the clothes or other accessories with us during the trip and the gravity generated by speed, the scooter will not support it if this load limit is exceeded.





## Limited Warranty Statement

### 30 DAY SATISFACTION GUARANTEED RETURN POLICY

If you are unsatisfied with your purchase, iscooter's return policy allows you to return the product purchased on the Authorization channel within 30 days counting from the date of receipt of shipment, and request a refund from the Authorization channel for any reason.

For the return request, iscooter is not responsible for lost packages due to the carrier, or products received that cannot be verified. Received products that have damage determined to have been caused by the end-user may be subject to denial of the return request.

### TO QUALIFY FOR A REFUND, ALL THE FOLLOWING CONDITIONS MUST BE MET

1. A Return Merchandise Authorization (RMA) must be requested from iscooter within 30 days from the date of receipt of shipment.  
To request an RMA, contact iscooter Service Team at [vip.support@iscooterglobal.com](mailto:vip.support@iscooterglobal.com).
2. The cost of return shipping will be borne by the customer.
3. For warranty service, please keep your receipt and/or invoice to validate proof of purchase.
4. Returned product must be in good physical condition (not physically broken or damaged).
5. All accessories originally included with your purchase must be included with your return.
6. If you return a product to iscooter, (a) without an RMA from iscooter(b) without all parts included in the original package, iscooter retains the right to refuse delivery of such return.

### LIMITED PRODUCT WARRANTY

1. iscooter warrants the original purchaser that your iscooter product shall be free from defects in materials and workmanship under normal use for a period aforementioned.
2. iscooter does not warrant the operation of the product will be uninterrupted or error-free. iscooter is not responsible for damage arising from failure to follow instructions relating to the product's usage.
3. Within 180 days after purchasing the scooter, if the battery is defective, it can be replaced free of charge. After exceeding this time limit, it needs to be replaced at a charge.
4. Only the original owner of an scooter purchased from iscooter online store is covered by this Limited Warranty. The Warranty Period begins upon your receipt of the scooter and shall end immediately upon the earlier of the end of the Warranty Period or any sale or transfer of the scooter to another person, and under no circumstances shall the Limited Warranty apply to any subsequent owner or other transferees of the scooter.

### LIMITED WARRANTY DOES NOT COVER

1. Normal wear and tear of any Covered Component.
2. Consumables or normal wear and tear parts (including without limitation tires, tubes, brake pads, cables, housing, grips).
3. Any damage or defects to Covered Components resulting from failure to follow instructions in the scooter owner's manual, acts of God, accident, misuse, neglect, abuse, commercial use, alterations, modification, improper assembly, installation of parts or accessories not originally intended or compatible with the scooter as sold, operator error, water damage, extreme riding, stunt riding, or improper follow-up maintenance.
4. For the avoidance of doubt, iscooter will not be liable and/or responsible for any damage, failure or loss caused by any unauthorized service or use of unauthorized parts.
5. The Battery is not warranted from damage resulting from power surges, the use of an improper charger, improper maintenance or other such misuses, normal wear or water damage.

## REMEDIES

- If a hardware defect is found and a valid claim is received by iscooter within the Warranty Period, iscooter will, at its option and to the extent permitted by law, either (1) repair the product at no charge, using new or refurbished replacement parts or, (2) replace the product with a new or refurbished product. In the event of a defect, to the extent permitted by law, these are your sole and exclusive remedies. Shipping and handling charges may apply except where prohibited by applicable law. This Limited Warranty is valid only in the jurisdictions where the products are sold by [www.iscooter.com](http://www.iscooter.com), and is valid to the extent permitted by the applicable laws of such jurisdictions.
- Any replacement hardware product will be warranted for the remainder of the original warranty period or thirty (30) days, whichever is longer, or for any additional period of time that may be applicable in your jurisdiction.

## HOW TO OBTAIN WARRANTY SERVICE

- A Warranty Service Order must be requested from iscooter within Warranty Period from the date of receipt of shipment. To request a Warranty Service Order, contact iScooter Service Team [vip.support@iscooterglobal.com](mailto:vip.support@iscooterglobal.com).
- To obtain warranty service, you must deliver the product, in either its original packaging or packaging providing an equal degree of protection, to the address specified by iscooter. In accordance with applicable law, iscooter may require the customer to furnish proof of purchase details and/or comply with registration requirements before receiving warranty service. period or thirty (30) days, whichever is longer, or for any additional period of time that may be applicable in your jurisdiction.

## LIMITATION OF DAMAGES

- Except to the extent prohibited by applicable law, iscooter shall not be liable for any incidental, indirect, special, or consequential damages, including but not limited to loss of, even when iscooter has been advised of the profits, revenue or data, resulting from any breach of express or implied warranty or condition, or under any other legal theory possibility of such damages.
- Some jurisdictions do not allow the exclusion or limitation of special, indirect, incidental or consequential damages, so the above limitation or exclusion may not apply to you.



## Question & Answer

1. What if the E-Scooter arrived with missing accessories or broken parts?

A: Please take a photo and send to iscooter Support Team by sending email: And iscooter Support Team will reply you soon and send correct accessory or part replacement.

2. Is the tire replaceable and how to replace the tire?

Yes, the tire is replaceable. Please contact iscooter support team for more information or search the video "How to replace the offroad tire" in YouTube instead.

3. What if the rear disc brake of the scooter doesn't work well?

A: You may please contact us for instructions of brake adjusting, or search "How to adjust rear brake of scooter" in YouTube for tutorial video as well.

4. What should I do when I hear an unusual noise coming from the rear wheel? A: It usually means your disc brake tilts to cause friction noise. Please see Disc Brake Adjustment page. If you still have problem, please contact us for help.

5. Why does the screen display an error code?

A: If you see any error code below, Please contact iscooter Support Team to remove the error code.

Error code	Definition
03	Check whether the 3-phase wire terminals and the Hall signal connector are in poor contact, or the system startup time exceeds 2S due to heavy load, such as climbing or the wheels are stuck. If this state still occurs after reconnecting the terminals, the controller or motor is damaged.
04	Low battery voltage protection, under voltage protection
06	Detect whether the Hall commutation signal of the motor is faulty, and check whether the connector of the Hall signal is in poor contact. If the state still occurs after reconnecting the terminals, the Hall of the motor is damaged.
07	When the system is powered on, detect whether the handlebar is out of control, or the handlebar signal is less than 0.75V. Or the handlebar is twisted before the system works, in this case the fault can be removed after resetting.
08	Controller failure
10	The controller cannot receive the dashboard signal
15	The controller cannot receive the dashboard signal

If the 5-core wire connecting the dashboard and the controller fails, the specific reasons may be as follows:

(1) If the dashboard cannot be turned on, the screen is black. Possible reasons: The main power line between the controller and the battery is not properly connected, or there is a problem with any one of the red, black, and blue wires connecting the dashboard and the controller.

(2) If the dashboard can be turned on, but it will stop working after working for 3s. Possible reasons: Any one of the green-yellow signal wires connecting the dashboard and the controller is in open state.



Contact us if you experience issues relating to riding, maintenance and safety, or errors/faults with your iscooter iX6 electric scooter.

✉ E-mail Service: [support@iscooterglobal.com](mailto:support@iscooterglobal.com)

🌐 [www.iscooterglobal.com](http://www.iscooterglobal.com)