

Sylvox

OUTDOOR TV

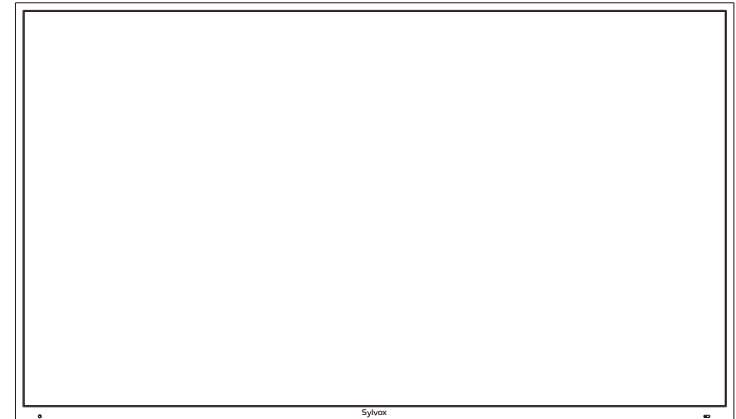

USER'S MANUAL

Note: The product and illustrations in this user's manual is only for explanation purposes and may vary depending on model.

USER'S MANUAL

BEDIENUNGSANLEITUNG

MANUEL DE L'UTILISATEUR

MANUALE D'UTENTE

MANUAL DE USUARIO

General Information

To avoid damaging the television set please observe the following safety instructions during setup and use.

Cleaning the television set	Before cleaning, disconnect the television set. Use only a soft damp cloth or a special cleaning product for flat-screens.
LED Display	Too much pressure on the screen can damage the television set.
Heat/damp/humidity	The television set should not be exposed to high temperatures (radiators, open fire). The television set should not be used in areas with high humidity.
Condensation	If moved from a cool area to one with a higher temperature, the television set should be left for at least an hour before plugging it in. A rapid change of temperature can lead to the formation of condensation in the television set itself. This can lead to damage if the television set is in use.
Air Circulation	To prevent overheating of the television set the ventilation slots at the rear should always be clear.
Small Objects	It is important to ensure that no small objects or liquids enter the television set. They can cause damage or even fire.
Liquids/Candles	Do not place anything holding a liquid or any candles on the television set.
Crushing	Take care to avoid crushing fingers or other objects when turning the television set in any direction.
Electric Supply	Use the television set only with the voltage indicated in the specifications. Ensure that there is easy access to the plug and that the television set can always be disconnected from the electricity supply. Do not disconnect the television set by pulling the power cable. Always take hold of the plug. The power cable must not be kinked or placed over sharp edges.
Moving the Television Set	When moving the television set, hold only the casing.
Repairs/Accessories	Repairs and servicing must be undertaken only by authorised and trained personnel.
	In accordance with the Batteries Regulation, batteries are to be disposed of only in containers provided for this purpose.



In extreme weather (storms, lightning) and long inactivity periods (going on holiday) disconnect the TV set from the mains. The mains plug is used to disconnect TV set from the mains and therefore it must remain readily operable. If the TV set is not disconnected electrically from the mains, the device will still draw power for all situations even if the TV is in standby mode or switched off.

IMPORTANT - Please read these instructions fully before installing or operating
WARNING: Never let people (including children) with reduced physical, sensory or mental capabilities or lack of experience and / or knowledge use electrical devices unsupervised.

- The TV set is intended for Outdoor and similar general use but may also be used in public places.
- For ventilation purposes, leave at least 5cm of free space around the TV.
- The ventilation should not be impeded by covering or blocking the ventilation openings with items, such as newspapers, table-cloths, curtains, etc.
- The power cord plug should be easily accessible. Do not place the TV, furniture, etc. on the power cord. A damaged power cord/plug can cause fire or give you an electric shock. Handle the power cord by the plug, do not unplug the TV by pulling the power cord. Never touch the power cord/plug with wet hands as this could cause a short circuit or electric shock. Never make a knot in the power cord or tie it with other cords. When damaged it must be replaced, this should only be done by qualified personnel.
- Do not expose the TV to dripping or splashing of liquids and do not place objects filled with
- liquids, such as vases, cups, etc. on or over the TV (e.g., on shelves above the unit).
- Do not place open flames such as lit candles on the top of or near the TV.
- Do not place any heat sources such as electric heaters, radiators, etc. near the TV set.
- Do not place the TV on the floor and inclined surfaces.
- To avoid danger of suffocation, keep plastic bags out of the reach of the babies, children and domestic animals.
- Do not dispose of the batteries in fire or with hazardous or flammable materials.
Warning: Batteries must not be exposed to excessive heat such as sunshine, fire or the like.
- If you think batteries might have been swallowed or placed inside any part of the body, seek immediate medical attention.

WARNING

Never place a television set in unstable or inclined locations. A television set may fall, causing serious personal injury or death. Many injuries, particularly to children, can be avoided by taking simple precautions such, Educating children about the dangers of climbing on furniture to reach the television set or its controls.

WALL MOUNTING WARNINGS

Read the instructions before mounting your TV on the wall.

The wall mount kit is optional.

Do not install the TV on a ceiling or on an inclined wall.

Use the specified wall mounting screws and other accessories.

Tighten the wall mounting screws firmly to prevent the TV from fall. Do not over-tighten the screws.

WARNING

This is not a recessed installable TV, Do not insert TV into the wall.

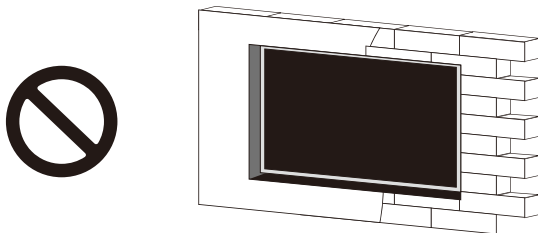

Accessories

Please make sure the following items are included with your TV.
 If any items are missing, Please contact us.



Remote Control

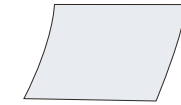

Warranty Card

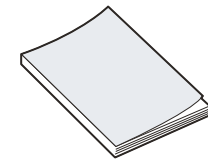

User's manual

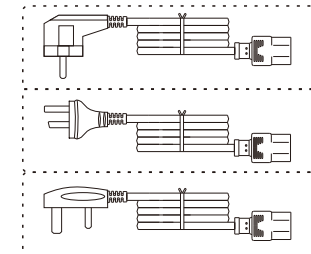

Euro Schuko plug power cord
 or AUS plug power cord
 or UK power cord



Screws BM8X14MM

(Matched with Sylvox Full Motion Cantilever Mount)



Screws BM8X28MM & Gasket

(Matched with Fixed Wall Mount)

Content

TV SPECIFICATION	1
INSTALLATION	2~4
OVERVIEW	5~6
SUPPORTING SIGNALS	7
REMOTE-CONTROL UNIT	8~9
General Description	10
TV OPERATION	11~26
READ BEFORE USING APPS	27
TROUBLESHOOTING	28~30
WARRANTY POLICY	31~32

TV Specification

Screen size	43"
Display Type	TFT LED
Resolution	3840 X 2160
Aspect Ratio	16:9
Alimentation	AC 100-240V 50/60Hz
Audio Output	L/R 10W X 2
Dimensions	38.40 x 22.56 x 3.45 inch
Operating Temperature	-22° to 122° F (-30° to 50°C)

Screen size	55"
Display Type	TFT LED
Resolution	3840 X 2160
Aspect Ratio	16:9
Alimentation	AC 100-240V 50/60Hz
Audio Output	L/R 10W X 2
Dimensions	48.98 x 28.60 x 3.45 inch
Operating Temperature	-22° to 122° F (-30° to 50°C)

Screen size	65"
Display Type	TFT LED
Resolution	3840 X 2160
Aspect Ratio	16:9
Alimentation	AC 100-240V 50/60Hz
Audio Output	L/R 10W X 2
Dimensions	57.61 x 33.45 x 3.45 inch
Operating Temperature	-22° to 122° F (-30° to 50°C)

Screen size	75"
Display Type	TFT LED
Resolution	3840 X 2160
Aspect Ratio	16:9
Alimentation	AC 100-240V 50/60Hz
Audio Output	L/R 10W X 2
Dimensions	66.32 x 38.35 x 3.45 inch
Operating Temperature	-22° to 122° F (-30° to 50°C)

Note:

Design and specification modification maybe made at any time without prior notice, all data and dimensions are approximations.

Installation

Fixed Wall Mount



Warning - Please read before installation
(Mounting Brackets are not supplied with TV)

Please thoroughly read instructions before attempting installation. The only suitable for the 43"-75" Outdoor TVs.

We advise that 2 people install the screen due to the heavy load of the screens.

Please be sure the mounting surface is strong enough to hold the weight of the screen.

Installation

Step1-Mounting Bracket to Wall

Fix the horizontal bracket into wall with screws.

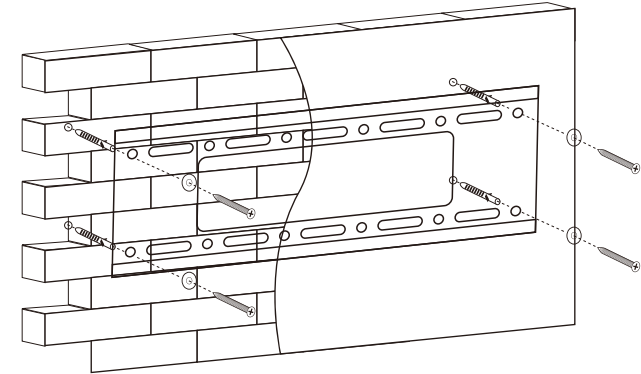

Step2-Mounting bracket to TV

Fix the vertical bracket on the back of TV with screws(M8).

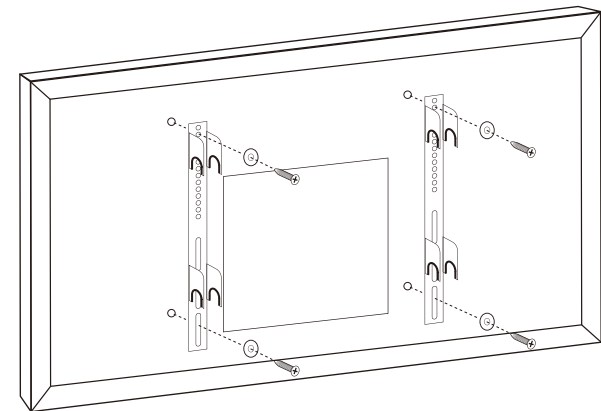

Installation

Step 3—Mounting TV to Bracket
Attach TV with brackets on wall.

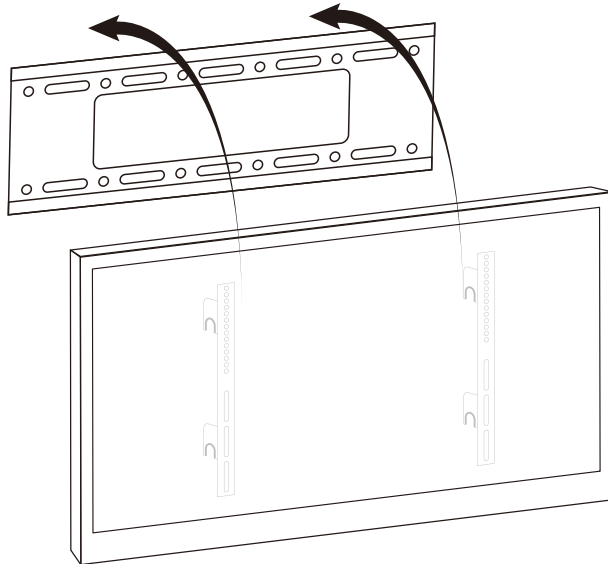

VESA Standard	43": 400 x 200 mm
	55": 400 x 200 mm
	65": 400 x 400 mm
	75": 600 x 400 mm

Overview

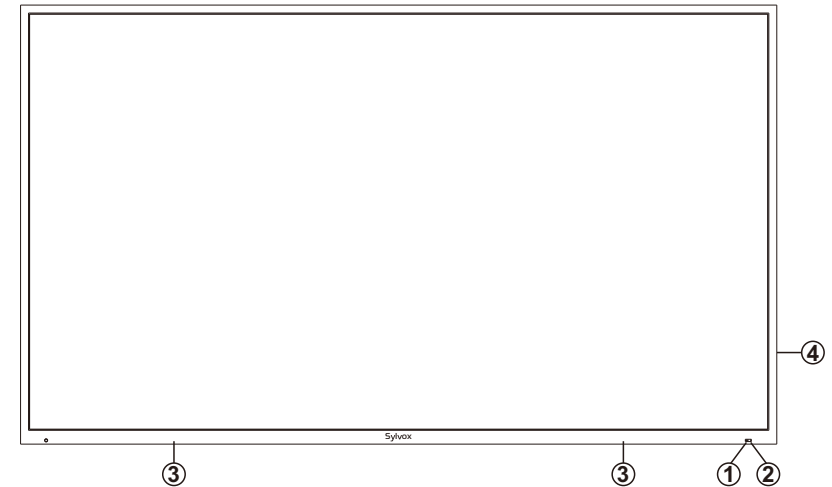

- ① REMOTE CONTROL SENSOR
- ② POWER INDICATOR
Green: In power on mode.
Red: In standby mode.
- ③ SPEAKER

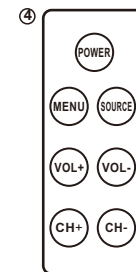

POWER

Press POWER button to toggle between normal and standby mode.

MENU

Press to see an on-screen menu of your TV's features.

SOURCE

Toggles between all the available input sources.

VOL+/-

Press to increase or decrease the volume. In the on-screen menu, use the VOL +/- buttons as left/right arrow buttons.

CH+/-

Press to change channels. In the on-screen menu, use the CH +/- buttons as up/down arrow buttons.

Overview

Connection Port

Please remove the waterproof panel on the back of the TV and you will see all the ports.

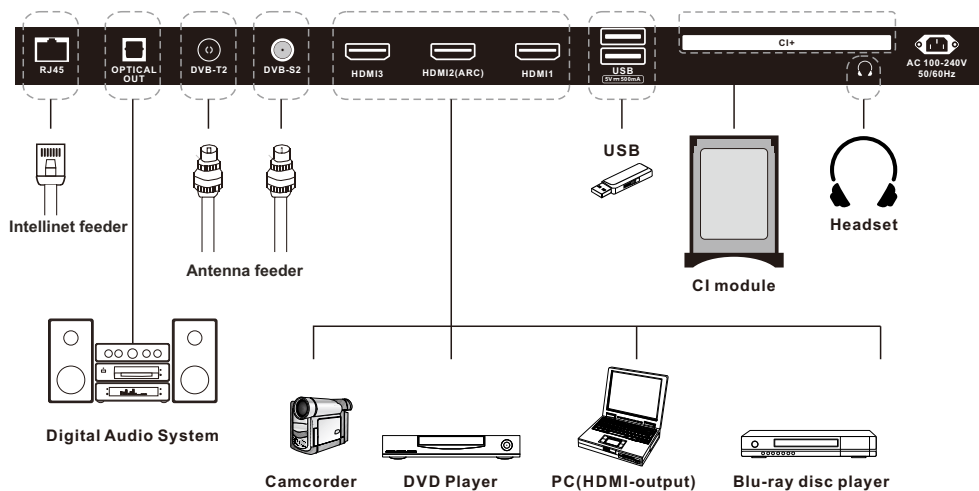
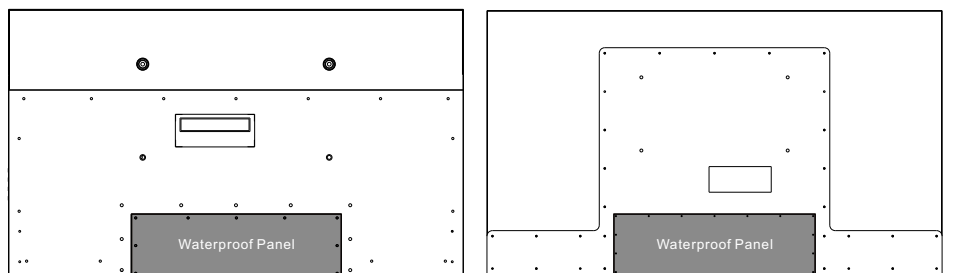

1. **RJ45**
Ethernet connection.
2. **OPTICAL OUT**
Digital audio output.
3. **DVB-T2**
Connected to external antenna to receive the ATV/DTV program in ATV/DTV mode.
4. **DVB-S2**
Connected to external SATELLITE to receive.
5. **HDMI1/2/3**
Connecting for HDMI signal.
6. **USB1/2**
USB input.
7. **CI+**
Used to insert the CI+ card.
8. **EARPHONE OUT**
Connecting for headphone.

Supporting Signals

Input	Mode
Digital	DVB-T/C/T2/S/S2
Analog	SECAM/PAL

PRESET MODE (HDMI)

	Resolution	V.Freq.(Hz)	H.Freq.(KHz)
1	640x480	59.94	31.469
2	720x480	59.94	31.469
3	720x576p	50	31.25
4	800x600	60	37.9
5	1280x720p	60	45
6	1920x1080i	60	33.75
7	1920x1080p	60	67.5
8	3840x2160	60	135

Remote-Control unit

1. **POWER:** Turn the TV on and off.
2. **Google Assistant:** Press to open the google assistant or start a voice search.
3. **Digital Buttons(0-9, -):** Directly select channel with digital buttons.
4. **SOURCE:** Press to open the input source list.
5. **NETFLIX:** If network connects, press this key to view NETFLIX directly.
6. **Google Play:** If network connects, press this key to view Google Play directly.
7. **YouTube:** If network connects, press this key to view YouTube directly.
8. **Prime Video:** If network connects, press this key to view Prime Video directly.
9. **HOME:** Display the HOME page.
10. **Arrow button ▲▼◀▶:** Use to select on-screen menu items and change menu values.
11. **MENU:** Display the main menu or exit the current menu.
12. **OK:** Confirms selection.
13. **BACK:** Return to the previous menu.
14. **MUTE:** Press this button to cut off the sound of the TV set temporarily, press again to resume.
15. **EXIT:** Exit the menu.
16. **VOL +/- :** Press these buttons to adjust the volume.
17. **COLOR BUTTONS:** It's used in the APPS.
18. **CHA/V:** Press these buttons to change channel upward or downward.

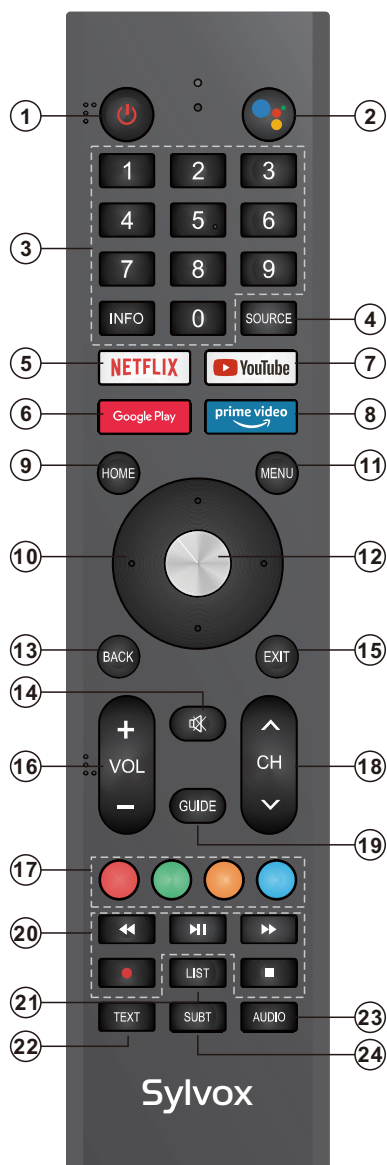

Remote-Control unit

19. **GUIDE:** Select electronic program guide, in DTV mode, it will display all the information of program in a week when pressing this button.
20. **DIGITAL MEDIA PLAYER CONTROL BUTTON:** Include backward, forward, play/pause, stop in USB mode. In DTV mode, press ● button to record the TV program. Please refer to relevant instructions in the section of multimedia player.
21. **LIST:** Press to display the channel list.
22. **TEXT:** Press to select the teletext mode.
23. **AUDIO:** Press to select mono, nicam, stereo for ATV channel, audio language for DTV channel.
24. **SUBT:** Open or close subtitle.

Loading batteries:

- 1) Remove the lid of the battery compartment.
- 2) Insert 2 size AAA batteries with polarities as indicated inside the compartment.
- 3) Replace the lid.

Note:

- 1) A loading of batteries should be last one year under normal use.
- 2) If you don't intend to use the remote control for a long period of time, remove batteries to avoid damage due to leakage.
- 3) Do not mix old and new batteries or different types.
- 4) Do not throw batteries into fire or water.
- 5) The batteries (battery pack or batteries installed) should not be exposed to excessive heat such as sunshine, fire or the like.



General Description

Installing Batteries in the Remote Control

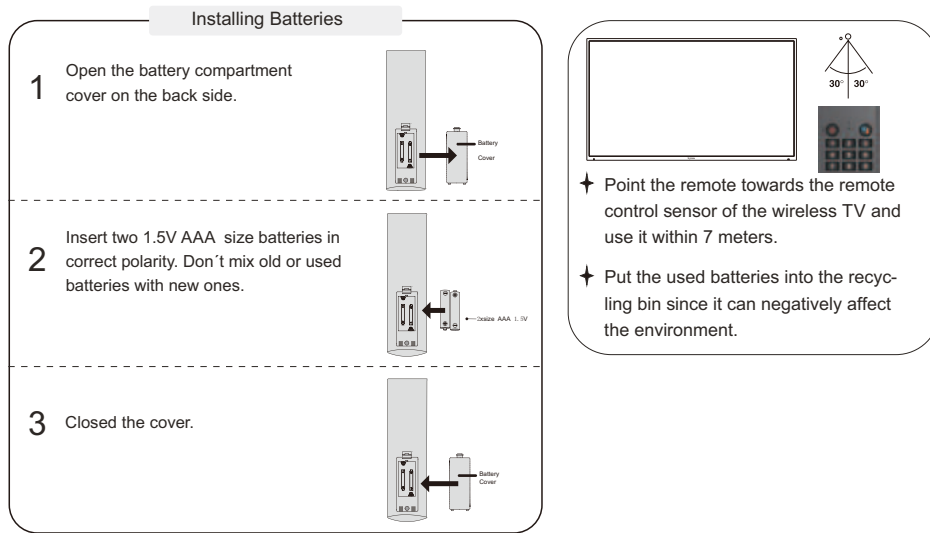

NOTES:

- One loading of batteries will last for 1 year under normal use.
- If you do not intend to use the remote controller for a long period of time, remove them to avoid damage due to leakage.
- Do not use old and new batteries together.
- The batteries (battery pack or batteries installed) shall not exposed to excessive heat such as sunshine, fire or the like.

External Connection

Antenna connection

Antenna input impedance of this unit is 75ohm. VHF/UHF 75ohm coaxial cable can be connected to the antenna jack directly, if the antenna cable is 300ohm parallel flat feeder cable, you need to use the 300ohm/75ohm converter to connect the antenna cable to the antenna jack. For details Please refer to the following drawing.

Antennas with 300ohm flat twins Leads

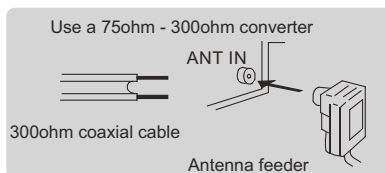

Antennas with 75ohm Round Leads

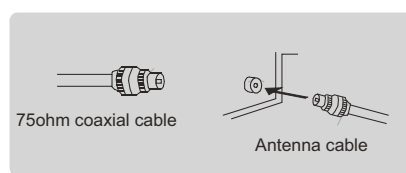

TV Operation

INITIAL SETUP

The first time you turn on your TV, the setup wizard will guide you through setting up basic settings. Please according to the Text Tip to First Time Setup.

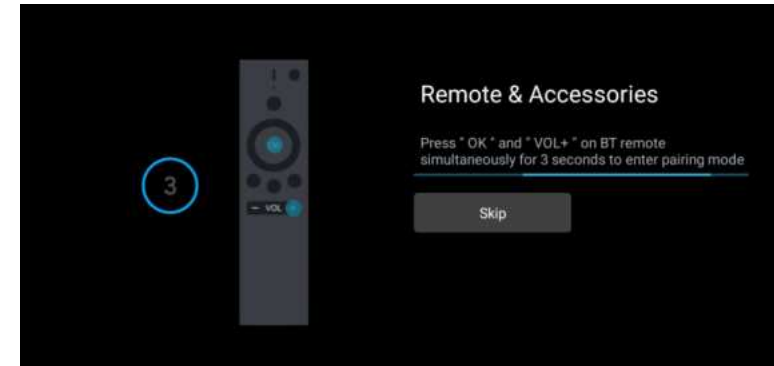

This function is used for the remote control pair code. After the code is successful, you can use the Bluetooth remote control to operate the TV.

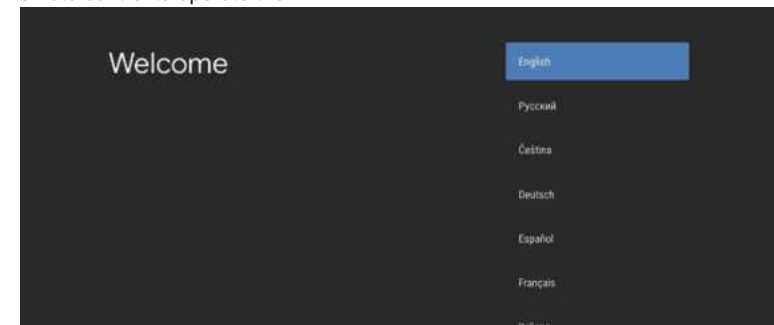

Press ▲/▼ to select the system language and press OK to confirm the language.



Connect your Android phone to your TV, select "Continue" to continue the connection, and choose "Skip" to skip this step.



Press ▲/▼ to select the wifi to connect, press OK and enter the password to confirm the connection is successful.

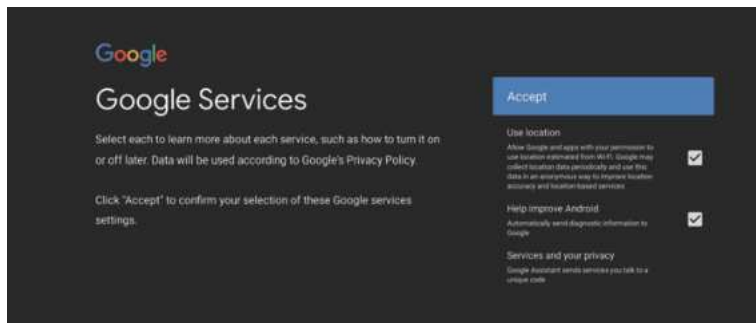

By agreeing to automatically send diagnostic information to Google to improve discriminative power, choose "YES" to accept.

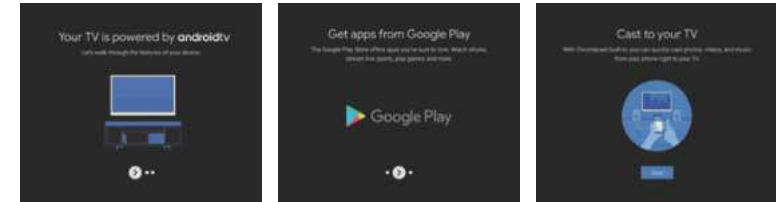

1. Your device is powered by Android TV and press the ► button to select the browsing feature.
2. You can get more apps from Google Play and press the ► button to go to the next screen.
3. Transfer photos and other content to the TV via the built-in chromecast, press OK to complete the browsing.

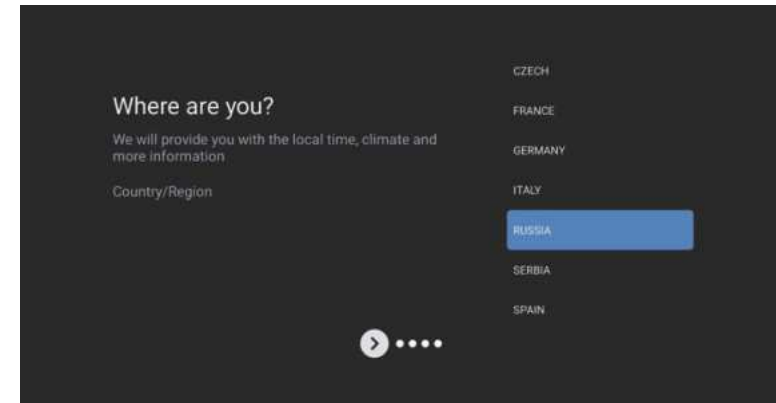

Press ▲/▼ to select the country of your device and press OK to confirm.

HOME SCREEN

After completing the wizard Settings, you can watch TV and go to the home screen.

①

②

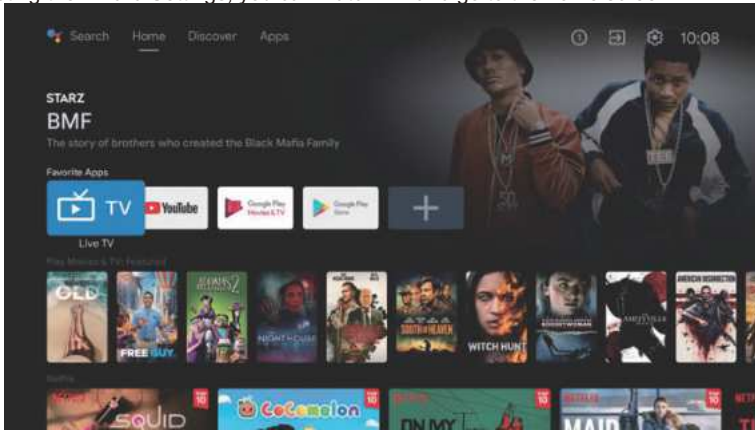

1. Open Google Assistant or start a text search.
2. Among the applications installed on the TV, the icons for the favourite applications are shown inside here. (Favourite applications can be added/ deleted/changed its order by users.)

📺 Inputs: Icon to select an input source.

⚙️ Settings: Various settings can be configured here. For details on the settings, see the next explanation.

INPUT SOURCE

In the HOME interface, press ▲/▼/◀/▶ to select the "Inputs" icon, press OK to open the input source list, then press up to highlight an input and press OK to switch.

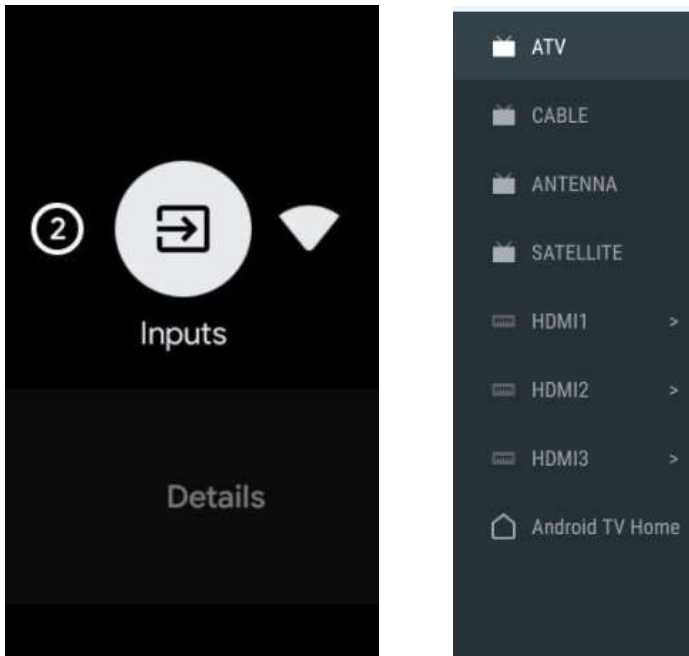

Under live TV, press the SOURCE button to display the list of input sources. You can select the desired source.

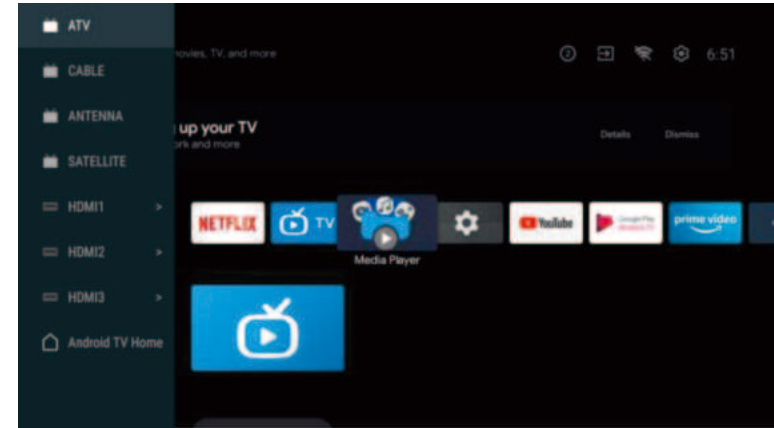

NAVIGATING THE ON-SCREEN MENU

1. In the HOME interface, press the ► key to select the icon of the circular settings menu, press OK to confirm.

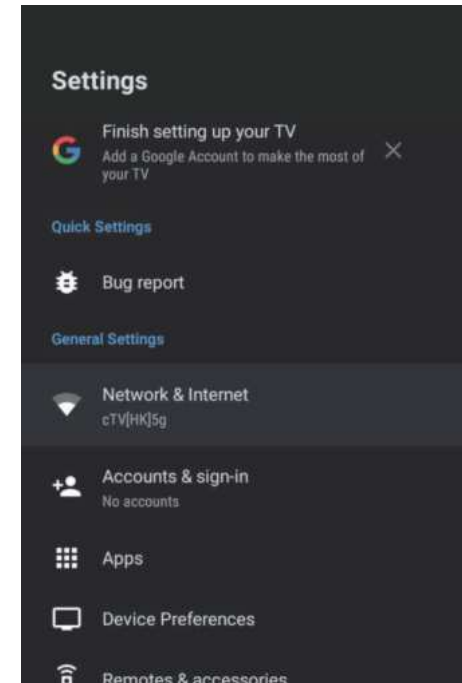

2. Press ▲/▼ button to select what you want set.
3. Press OK to enter setting.

Network

- 1 Press ▲/▼ button to select what you want set.
2. press OK button to adjust.
3. After finishing your adjustment, press OK button to save and return to the previous menu.

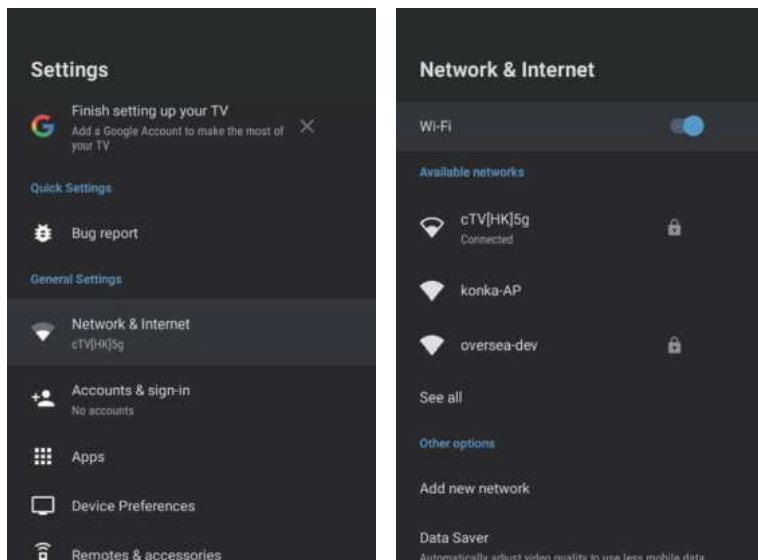
**Antenna**

1. Go into LiveTV App -> Channel -> Channel Scan -> Tuner Mode enter, choose Antenna.

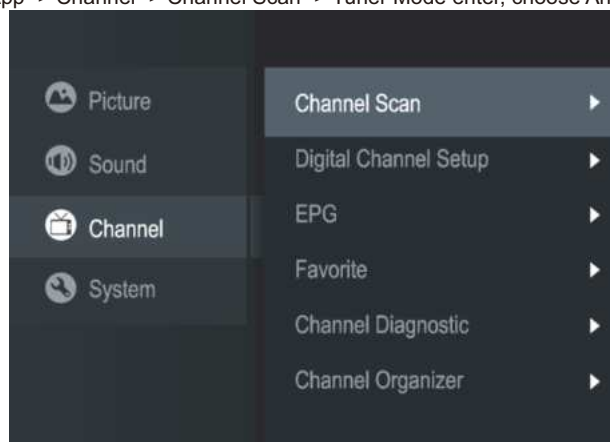

2. Enter Menu -> Channel -> Channel Scan.

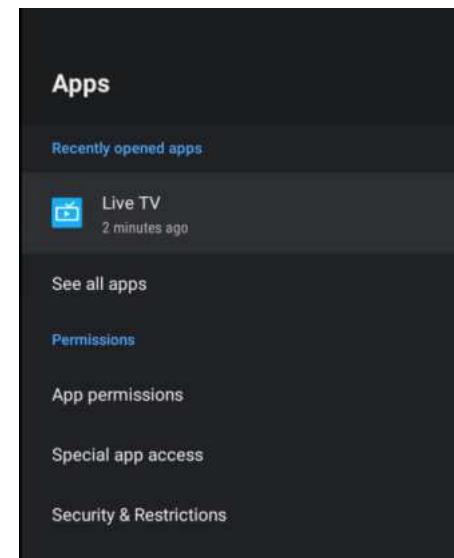
APPS

In this menu, you can set the APP permissions, and read the app lists.

1. Press ▲/▼ button to select what you want set.
2. Press OK button to adjust.
3. After finishing your adjustment, press BACK button to return to the previous menu.

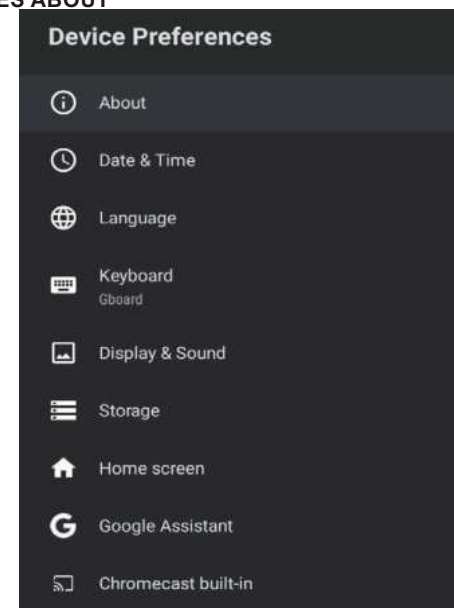
DEVICE PREFERENCES ABOUT

In this menu, you can read the information and settings of TV.

1. Press ▲/▼ button to select what you want set.
2. Press OK button to adjust.
3. After finishing your adjustment, press BACK button to return to the previous menu.

DATE & TIME

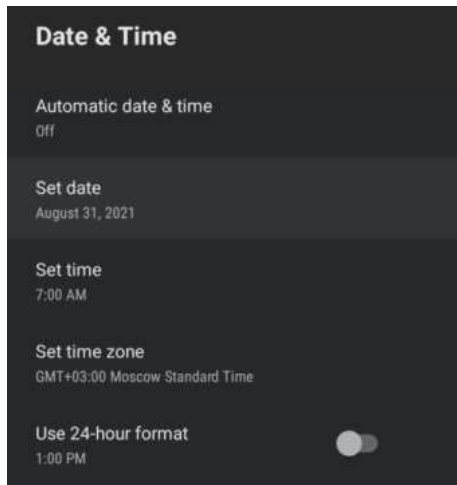

Automatic date & time- Press ▲/▼ button to select the option then press OK button to enter the sub-menu.(Optional: Use network-provided time, Off)

- Manually adjusting date & time settings will automaticall change the Automatic date & time to OFF.

Set date- Press ▲/▼ button to select the option then press OK button to enter the sub-menu.

Set time- Press ▲/▼ button to select the option then press OK button to enter the sub-menu.

Set time zone- Press ▲/▼ button to select the option then press OK button to enter the sub-menu.

Use 24-hour format- Press ▲/▼ button to select the option then press OK button to choose ON/OFF.

LANGUAGE

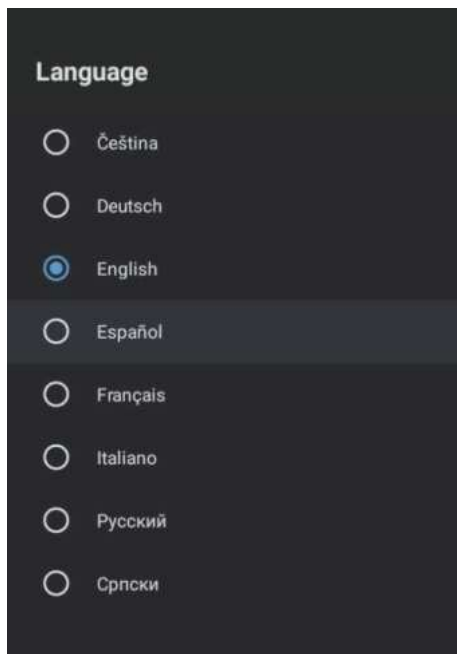

Language- Press ▲/▼ button to select the option then press button to enter the OK select language.

KEYBOARD

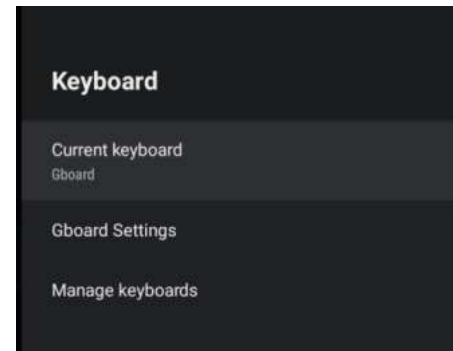

Current keyboard- Press ▲/▼ button to select the option then press OK button to enter the sub-menu.

Gboard Settings- Press ▲/▼ button to select the option then press OK button to enter the sub-menu.

Manage keyboards- Press ▲/▼ button to select the option then press OK button to enter the sub-menu.

ENERGY SAVER

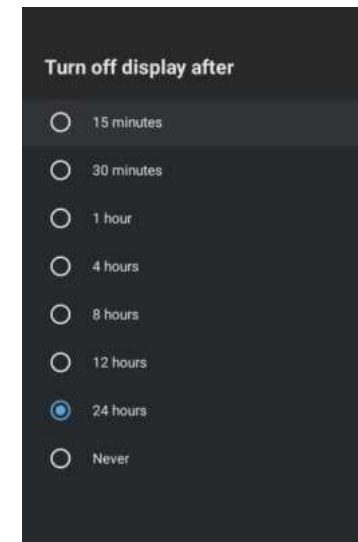

Turn off Display- Press ▲/▼ button to select the option then press OK button to enter the sub-menu.
(Options: 15 minutes, 30 minutes,24 hours, Never.)

SOUND



Press MENU key to the main menu, and select Sound.

Sound Mode- Press OK to enter the sub-menu, press button to select option and press OK to select the option.

Pure Sound- Press ▲/▼ button to select the option then press OK button to choose ON/OFF.

Surround- Press ▲/▼ button to select the option then press OK button to choose ON/OFF.

Sound Only- Press OK to enter the sub-menu, press OK button to select option.

Output Device- Press ▲/▼ to enter the sub-menu.

Audio Output Type- Press ▲/▼ to enter the sub-menu.

Advanced Settings- Press ▲/▼ to enter the sub-menu.

PICTURE

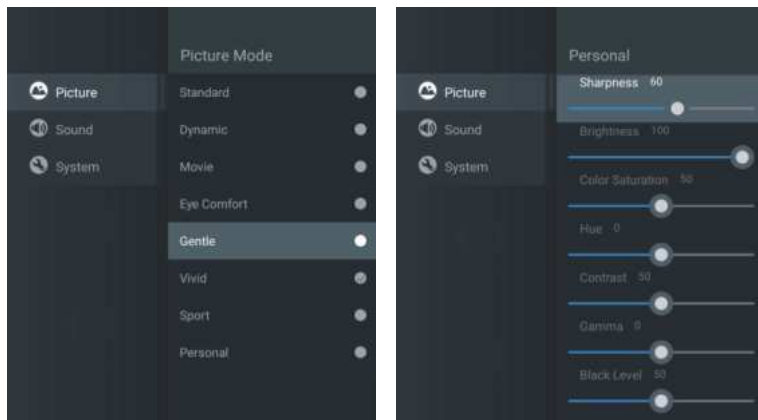

Picture Mode- Press ▲/▼ button to select the option button to enter the sub-menu.(Optional: Standard, Dynamic, Movie, Eye Comfort, Gentle, Vivid, Sport, Personal).

Brightness/Color Saturation/Hue/Contrast/Gamma/Black Level Sharpness- Press ▲/▼ button to select the option.

Press ◀ to decrease the parameter. Press ▶ to increase the parameter.

Gamma- Press ▲/▼ button to select the option.

Press ◀ to decrease the parameter.

Press ▶ to increase the parameter.

STORAGE

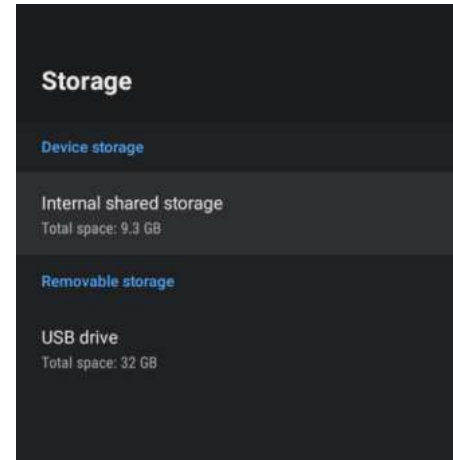

Internal shared storage- Press ▲/▼ button to select the option then press OK button to enter the sub-menu.

Removable Storage- Press ▲/▼ button to select the option then press OK button to enter the sub-menu.(Note: Show external devices if available)

HOME SCREEN

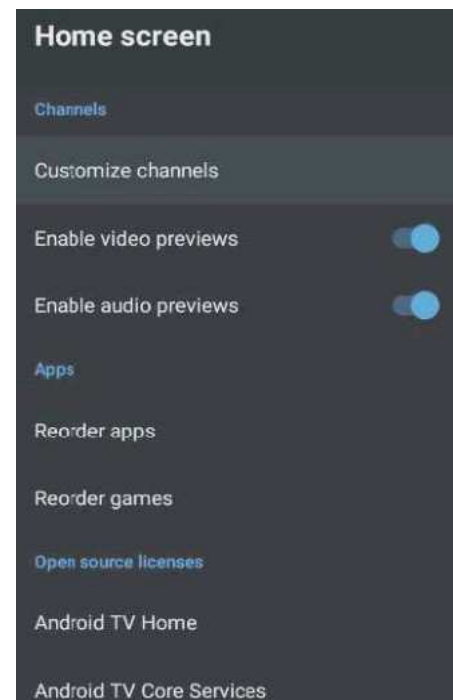

In this menu, you can set channels, apps, open source licenses.

1. Press ▲/▼ button to select what you want set.

2. Press OK button to adjust.

3. After finishing your adjustment, press BACK button return to the previous menu.

GOOGLE

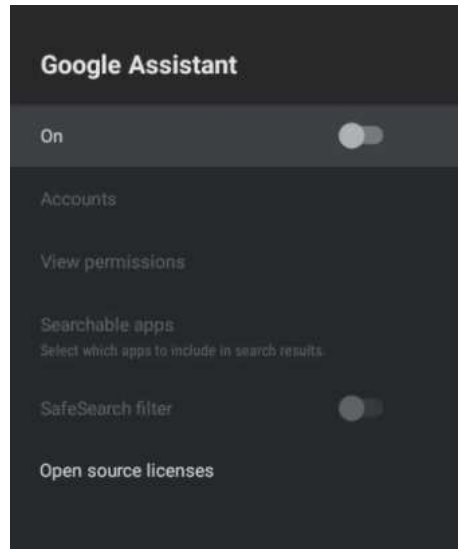

In this menu, you can set searchable apps, safe search filter, block offensive words, open source licenses.

1. Press ▲/▼ button to select what you want set.
2. Press OK button to adjust.
3. After finishing your adjustment, press BACK button return to the previous menu.

CHROMECAST BUILT-IN

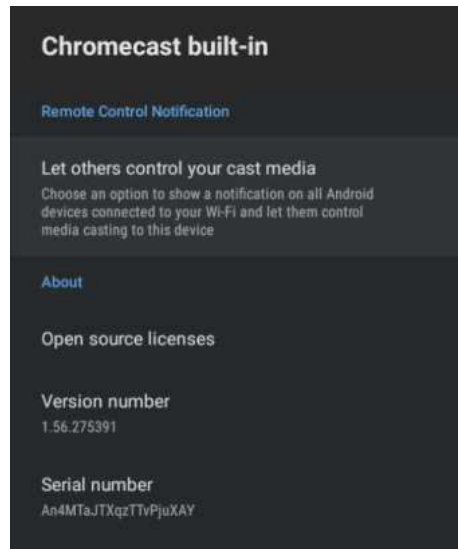

In this menu, you can read the information and settings of Chromecast.

1. Press ▲/▼ button to select what you want set.
2. Press OK button to adjust.
3. After finishing your adjustment, press BACK button return to the previous menu.

SCREEN SAVER

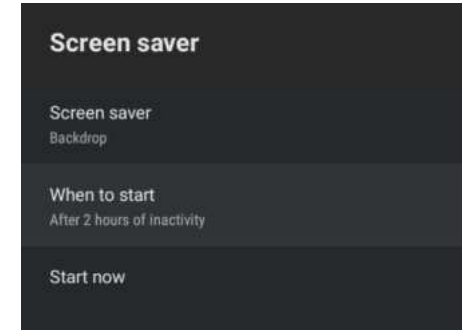

Screen saver- Press ▲/▼ button to select the option then press OK button to enter the sub-menu.(Optional: Turn screen off, Backdrop, Colors)

When to Start- Press ▲/▼ button to select the option then press OK button to enter the sub-menu. (Optional: 5 minutes, 15 minutes, 30 minutes, 1 hour, 2 hours.)

Start now- Press ▲/▼ button to select the option then press OK button to enter screen saver.

LOCATION

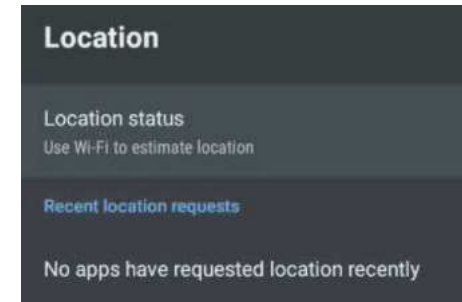

Location status- Press ▲/▼ button to select the option then press OK button to enter the sub-menu. (Optional: Use Wi-Fi to estimate location, Off)

USAGE & DIAGNOSTICS

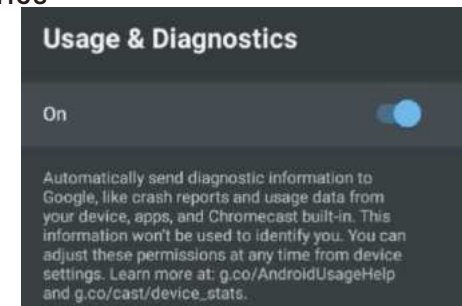

Usage & diagnostics- Press ▲/▼ button to select the option then press button OK to choose ON/OFF.

ACCESSIBILITY

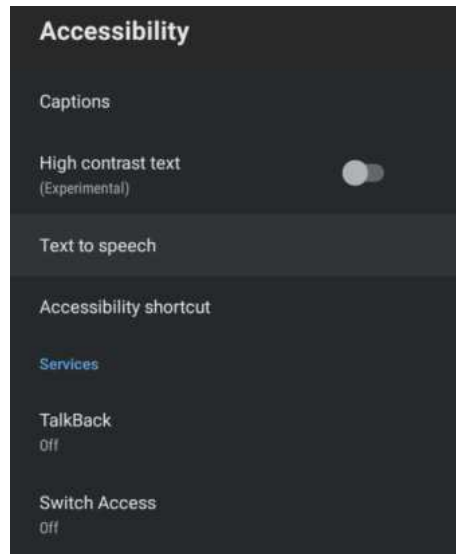

Captions- Press ▲/▼ button to select the option then press OK button to enter the sub-menu.

High contrast text- Press ▲/▼ button to select the option then press OK button to choose ON/OFF.

Text to speech- Press ▲/▼ button to select the option then press OK button to enter the sub-menu.

Accessibility shortcut- Press ▲/▼ button to select the option then press OK button to choose ON/OFF.

TalkBack- Press ▲/▼ button to select the option then press OK button to enter the sub-menu.

Switch Access- Press ▲/▼ button to select the option then press OK button to enter the sub-menu.

RESTART

Press OK button to enter the sub-menu.

Restart the TV.

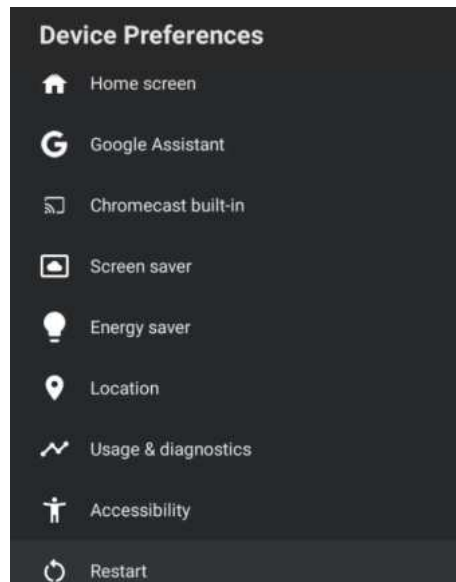

REMOTES & ACCESSORIES

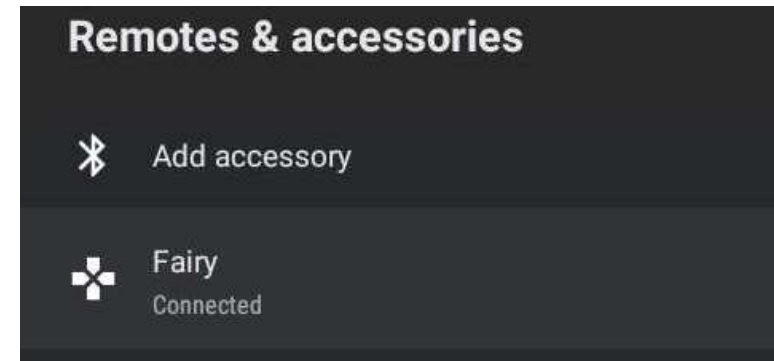
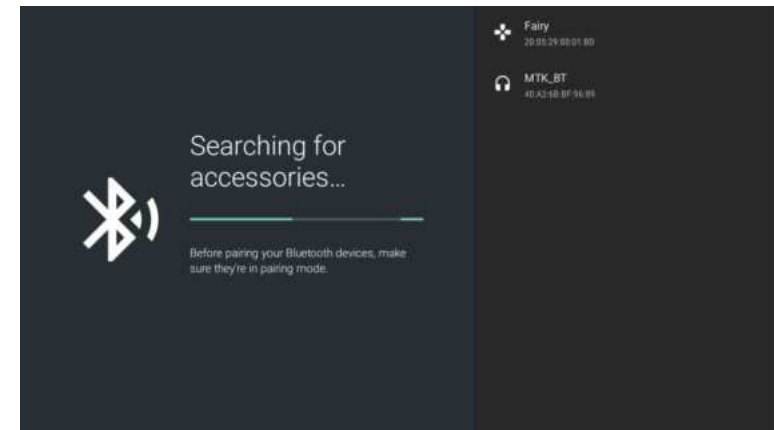

Note: It is only available to the remote control with Bluetooth.

In this menu, you can pair Bluetooth devices.

1. Press "OK" and "Volume+" buttons for about 5 seconds.
2. When the LED starts to flash, release it. The remote controller will send the pairing signal to the TV and display the information of the remote control on the right side of the screen.
3. Press the OK button to display the pairing. If the paired is displayed, the connection is successful.
4. Press BACK button return to the previous menu.

NOTE

The menu/function may be different depending on when you purchased the TV.

ADD AND USE OF MEDIA PLAYER

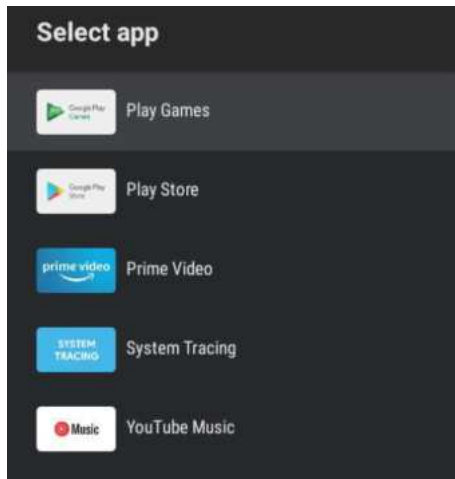

1. In the HOME interface, select the + icon in the APP column to add the application, and click OK. Press up and down to select the Media Player application, and click to add it OK to the HOME interface.



2. Focus on the corresponding USB driver and press OK to display video, photo, audio files. Press navigation button to select the file.

Read Before Using Apps

(*Terms & Conditions Apply)

- Due to the product characteristics featured on the Apps store, as well as limitations in available content, certain featured applications, and services may not be available on all devices or in all territories. Some Apps featured may also require additional peripheral device or membership fees. Services and content availability are subject to change without prior notice.
- Manufacture takes no legal responsibility whatsoever for any interruption of App services caused by the service provider for any reason.
- An unstable Internet connection may cause delays or interruptions. In addition, applications may terminate automatically depending on the network environment.
- Applications services and updates may become unavailable.
- Application content is subject to change by the services provider without prior notice.
- Specific services may differ with the version of the application installed on the TV.
- An application's functionality may change in future version of the application.
- Depending on the third party service provider/s policies, certain applications may not support multitasking.
- The response to remote commands and the resulting on screen display may be delayed while a webpage is loading.
- The copy and paste operations are not supported.
- The web browsing speed will differs with the network environment.
- Depending on the types of video/audio codecs supported, it might not be possible to play certain video and audio files while playing content.
- Apps store have certain limitation, it consist many inbuilt apps for various needs of user but user doesn't have facility to add other apps from any other media.

Troubleshooting

If you have any problem, check the counter measures for each symptom listed below. The following symptoms may have been caused by inappropriate adjustment rather than actual malfunction of the unit. If the trouble persists, contact the Customer Care Centre, see back page for contact details.

Symptoms	Possible solutions
No power	Please check the power cord plugged in and that the power outlet works. Unplug the power cord and plug it in after 60 seconds and restart the TV.
No picture	Please check antenna connection. Station may be experiencing problems, please tune to another station. Please adjust the settings of contrast and brightness.
Good picture but no sound	Please increase the volume. Please check TV is under mute mode, press MUTE button on the remote control. Please check sound settings. If external devices are being used, check their volumes are not set too low or turned off. If using AVI or Component inputs, please make sure cables are connected properly and not loose. If using DVI to HDMI cable, a separate audio cable is required. Make sure a headphone jack >s not connected.
Good sound but abnormal color or no picture	Please check antenna connection and antenna condition. If using Component input, please check Component connections, incorrect or loose connections may cause colour problems or cause the screen to be blank.
No response to remote control	Batteries of remote control may have exhausted, if necessary, please change the batteries. Clean the remote control lens. The distance between LED TV and remote control should be within 8m, within recommended operating angle and path is free of obstructions.
Colored dots may be present on the screen	Although the LED screen is made with high-precision technology and 99.99% or more of the pixels are effective, black dots may appear or bright points of light (red, blue, or green) may appear constantly on the LED screen. This is a structural property of the LED screen and not a malfunction.
Picture is breaking up	Keep the TV away from noisy electrical sources such as cars, hair dryers, welders, and all optional equipment. Electrical atmospheric interference such as local or distant lightning storms may cause picture to break up. When installing optional equipment, leave some space between the optional equipment and the TV. Check the antenna and connection. Keep the antenna away from any power or input/output cables.

Symptoms

Possible solutions

After Auto Tuning only some channels are available	Check your area is covered by Digital Video Broadcasts. Try re-tuning or manually tuning missing channels. Check that you are using the correct antenna type.
Channel cannot be selected	Check if the channel has been blocked in the main menu settings. Please check connecting USB cable and power supply is connected. Hard drive has not been formatted. Please make sure USB disk is compatible and the multimedia data formats are supported. Only support FAT32 format for the USB disk.
USB not playing	Compression of video contents may cause distortion especially on fast moving pictures such as sports and action movies.
Picture is distorted, macroblock, small block, dots, pixelization, etc	Check cable connections, make sure a video cable is not connected to an audio input. Low signal level may cause sound distortion.
Noise from speaker	Check if the Off Timer is set to On in the Setup menu. Sleep Timer may have been enabled. If there is no signal for about 10 minutes from an input, the TV will turn off.
TV turns off automatically	Check if the On Timer is set to On in the Setup menu.
TV turns on automatically	Black bars on each side will be shown on HD channels when displaying SD (4:3) contents. Black bars on Top & Bottom will be shown on movies that have aspect ratios different from your TV. Adjust picture size option on your external device or TV to full screen.
Picture is not shown in full screen	

WARNING

Never place a television set in an unstable location. A television set may fall, causing serious personal injury or death. Many injuries, particularly to children, can be avoided by taking simple precautions such as:

- Using cabinets or stands recommended by the manufacturer of the television set.
 - Only using furniture that can safely support the television set.
 - Ensuring the television set is not overhanging the edge of the supporting furniture.
 - Not placing the television set on tall furniture (for example, cupboards or bookcases) without anchoring both the furniture and the television set to a suitable support.
 - Not placing the television set on cloth or other materials that may be located between the television set and supporting furniture.
 - Educating children about the dangers of climbing on furniture to reach the television set or its controls
- If your existing television set is being retained and relocated, the same considerations as above should be applied.

The plug or appliance coupler is used as the disconnect device, the disconnect device shall remain readily operable.

THE DISPOSAL OF ELECTRICAL AND ELECTRONIC EQUIPMENT WASTE PRODUCTS ON THE PART OF FINAL USERS IN THE EUROPEAN UNION

This symbol on the product or on the container indicates that this product cannot be eliminated with the general waste. The user is responsible for eliminating this kind of waste by throwing them away at a "recycling point" specifically for electrical and electronic waste. Selective collection and electrical equipment recycling contribute to preserve natural resources and warrant waste recycling to protect environment and health. In order to receive further information about electrical and electronic waste collecting and recycling, contact your Local Council, the service of household waste or the establishment where the product was acquired.

The crossed out "wheeled bin" symbol on the product reminds you of your obligation, that when you dispose of the appliance, it must be separately collected.



Warranty

Thank you for purchasing this Sylvox product. We are glad to offer 12 months free warranty for you. If you have any questions, please contact us via our after-sales email or website for assistance.

After-sales email:

service.eu@sylvoxtv.com
service.uk@sylvoxtv.com
service.au@sylvoxtv.com

Website:

www.sylvoxtv.eu

Customer Service Support:

Service Hotline-USA: +1(833)379-5869 (Monday-Friday,9:00AM-5:00PM EST)

Warranty Policy

(1) When returning an item, please note the following:

1. Only items purchased directly from www.sylvoxtv.eu and authorized resellers can be returned, such as Amazon, Walmart, Newegg, Wayfair, Aliexpress, etc.
2. We will not accept any return requests for products purchased from unauthorized third-party suppliers.
3. Customer must contact the original vendor with your order ID or purchase proof and the detail of the product issue at Sylvox-Team to request a return/refund/repair/replace before returning products. Sylvox will provide you with the shipping label in the mail.
4. Sylvox are responsible for all return shipping costs for quality problem.
5. If there is no reason to return the product after installation and use, Sylvox shall have the right to charge restocking fees of 20% of the product value. (Only accept applications for no reason return within 7 days after arrival, and freight costs are the responsibility of the customer)
6. Ensure that the item(s) you are returning is repackaged in the original condition with all the documentation and accessories that came with it.
7. If the returned product is not in original packaging: artificial damage causes to affect the second sale, such as its appearance being damaged, the lack of accessories, etc., we will deduct the corresponding expenses according to the situation.
8. We will handle your request once getting your returning item.

(2) How to return a product for a refund? (30 days money-back guarantee)

To return an item to Sylvox, Please contact the Sylvox-team to submit an after-sales application, we will provide you with the shipping label in the mail.

Please include your original order number or order proof in the email and ensure that the item is returned within 30 days. No refunds will be issued until the item is received in its original packaging (with its documentation and accessories).

(3) Refunds

Once we receive and verify the condition of your product, a refund is initiated. The way your refund is processed depends on your original payment method.

For credit or debit cards, refunds will be back to the card-issuing bank within 7-10 business days of receipt of the returned item. Please contact the card-issuing bank with questions about when the credit will be posted to your account.

(4) What does the warranty not cover?

- (a) The wrong way of use and improper repair by the user caused the failure or damage.
- (b) Failure or damage caused by transportation, moving, and falling after purchase.
- (c) Other unavoidable external factors cause failure and damage.
- (d) Improper use of the equipment caused by water or other solution of damage.
- (e) Failure caused by a lightning strike or other electric system reasons
- (f) Damage caused by using power supply other than specified voltage.

Warranty Period:

- * Sylvox repairs the TV free of charge under the condition of the normal use of the instruction manual within 12 months.
- * Sylvox warrants that this product conforms to the manufacturer's specifications and will be free of defects in material and workmanship should any defect occur.
- * Sylvox will correct the defect subject to the following conditions:
 - (a) Any defects caused or repairs required as a result of the abusive operation, negligence, accident, shipment damages, improper delivery and installation, application, and use for which this product was not intended as set forth in the user's manual or other applicable Product documentation.
 - (b) Any defects caused or repairs required as a result of any product that has been tampered with, modified, adjusted, or repaired by any person other than Sylvox, a Sylvox authorized service provider or a Sylvox authorized service center or dealer.
 - (c) Any replacement of accessories, glassware, consumable or peripheral items required through normal use of the Product, including but not limited to, earphones, remote controls, batteries, etc.
 - (d) Any cosmetic damage to the Product surface or exterior, including but not limited to that which has been defaced or caused through normal wear and tear, improper shipping and handling, or the use of chemical cleaning agents.
 - (e) Any defects caused or repairs required as a result of damage caused by any external or environmental conditions, including but not limited to, the use of incorrect voltage, fluctuations or surges in transmission line/power line voltage, liquid spillage, or acts of nature or God.
 - (f) Warranty claims for Products returned with the altered, illegible, or missing model, factory serial number, and UL markings.
 - (g) Any Products used for rental, business, or commercial purposes.
 - (h) Any installation, consumer instruction, delivery, setup, adjustment, and/or programming charges.
 - (i) A Product that is not installed following installation instructions is included with the Product.
 - (j) Any signal reception problems (including antenna-related problems), images "burnt" into the screen, signal noise or echo, interference or other signal transmission or delivery problems, availability of third-party provided services or content (including, without limitation, image, audio or video content).

No other entity other than Sylvox is authorized to extend, enlarge or transfer this warranty on behalf of Sylvox.

The express warranties in this limited warranty are, in lieu of and, except to the extent prohibited by applicable law, Sylvox disclaims all other warranties and conditions, express or implied, whether arising by law, statute, by course of dealing, or usage of trade, including, without limitation, implied warranties or conditions of all claims, whether based in contract, negligence, strict liability or otherwise. Some states do not allow the exclusion or limitation of incidental or consequential damages, so the above limitation or exclusion may not apply to you.

For any questions, feel free to contact us via service.eu@sylvoxtv.com at any time!
service.uk@sylvoxtv.com
service.au@sylvoxtv.com

Sylvox

OUTDOOR-FERNSEHER

