

# SMARTBOXY

CATALOG 2023



BIN BO  
XY

PARCEL BO  
XY

FIRE BO  
XY

GARDEN BO  
XY

CAREGE BO  
XY

KITCHEN BO  
XY



Passion for creating

# SMART PRODUCTS

We are an independent manufacturer with our own R&D department, offering products of the highest quality, modern design, and excellent weather resistance. Our products are the result of our passion for innovation and a relentless pursuit of excellence.

Our R&D team consists of experienced and creative designers and engineers who constantly work on developing new solutions. We strive to ensure that our products not only meet the highest quality standards but also stand out with innovative designs that set new trends in the market.

All our products are meticulously designed and tested for durability and resistance to variable weather conditions. We use durable, high-quality materials that provide long-lasting protection against UV rays, moisture, corrosion, and other external factors. As a result, our products maintain their appearance and functionality even in challenging conditions.

Our goal is to provide our customers with products that are not only aesthetically appealing but also practical and durable. Whether you're looking for outdoor furniture, exterior lighting, storage systems, or other outdoor products, you can be confident that our offerings will meet your expectations in terms of quality, design, and longevity.

As an independent manufacturer, we have full control over the production process, enabling us to maintain high quality and meet the individual needs of our customers. We prioritize innovation, impeccable craftsmanship, and customer satisfaction.

Thanks to our efforts, we take pride in the fact that our products are appreciated by both individual customers and industry professionals. We offer products that are not only practical but also add character and beauty to any outdoor space.

If you're seeking products of the highest quality, with modern design and excellent weather resistance, our offering is perfect for you. We are confident that our products will meet your expectations and contribute to creating a beautiful and functional outdoor space.

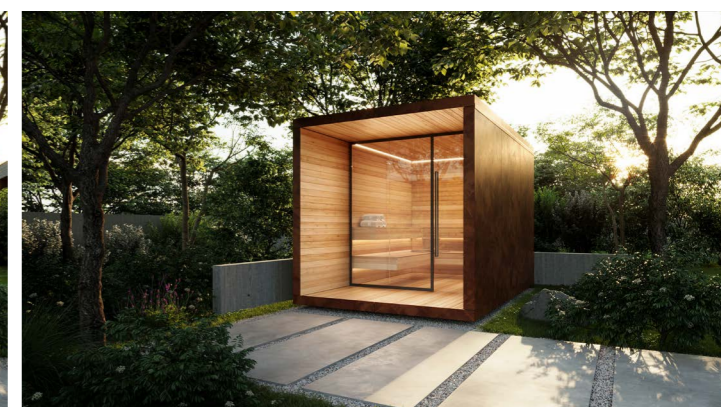
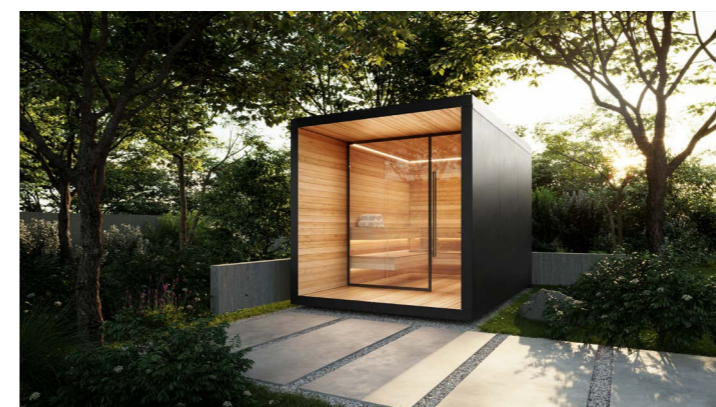

Coming soon: **SaunaBOXY**



23



## BinBOXY

In response to the growing demand for solutions that are characterized by modern design, we have created covers for household garbage containers that harmonize with the modern exterior of the house. Stylish and practical modular systems for storing bins BIN BOXY - modern enclosures for bins, thanks to which the home environment will gain an aesthetic appearance, and waste bins will be aesthetically hidden from view, becoming an interesting complement to the backyard space arrangement. Be ECO and live more beautifully!

BIN BOXY enclosures have a universal size for bins from 120-240 liters. In addition to the basic construction solutions mentioned above, in this version also the front door is made of galvanized steel, which perfectly matches the elegant and minimalist character. Stable steel construction ensures quality and reliability for many years. The door is equipped with an integrated handle for opening. In addition, the logo burned into the handle perfectly complements the whole.

## DIMENSIONS

### FLORA

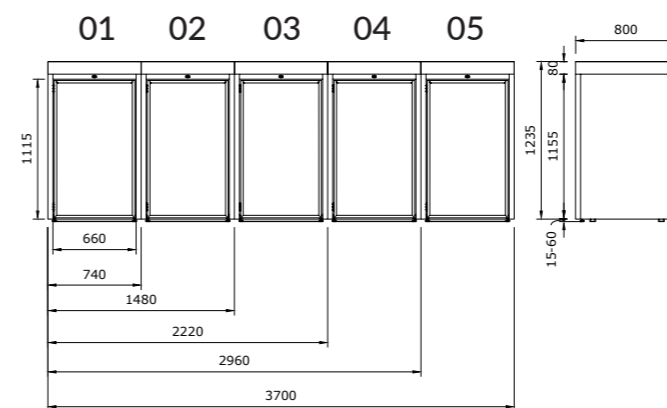

### HATCH

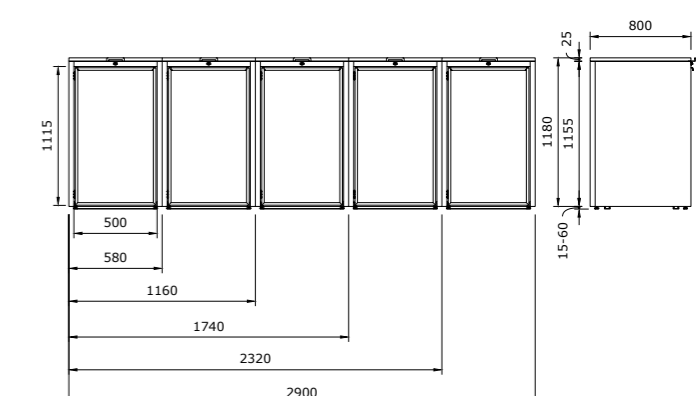
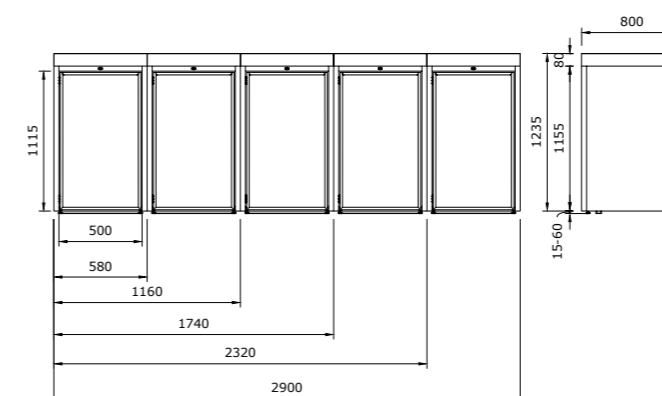
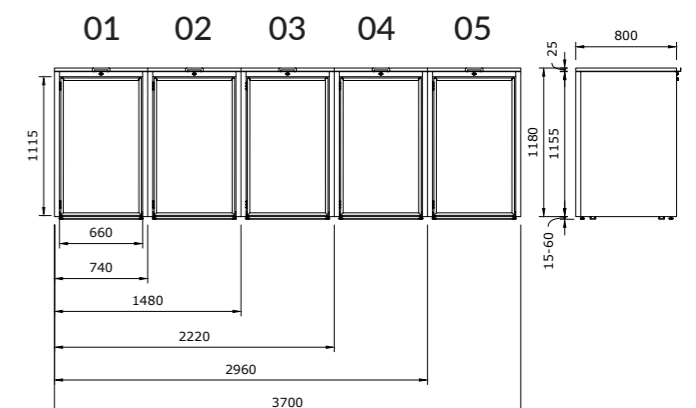

FLORA



HATCH



ACCESSORIES

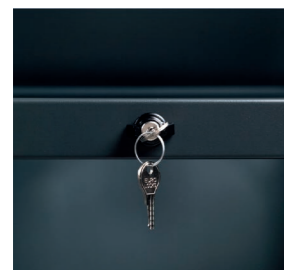

LOCK



CHAIN



SHELF



HATCH - OPENING WAY



WHEEL LIMIT

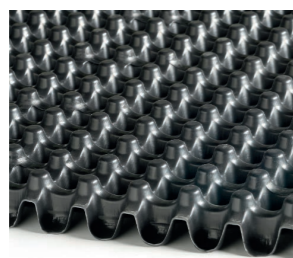

DRAINAGE MAT - FLORA



PLATE WITH LOGO



HATCH - OPENING WAY\*  
\* FLAPES OPEN AS REVERSE  
\* THE LOCK IS NOT POSSIBLE TO USE

TYPE CONSTRUCTION FLORA



FLO 01

FLO 02

FLO 03

FLO 04

FLO 05



RAL 7016



RAL 9005



RAL 7045



RAL 7016\_WOOD



RAL 9005\_WOOD



RAL 7045\_WOOD



RAL 7016\_CORTEN



RAL 9005\_CORTEN



RAL 7045\_CORTEN



FRONT PERFORATION OPTION



TYPE CONSTRUCTION HATCH



HAT 01

HAT 02

HAT 03

HAT 04

HAT 05



RAL 7016



RAL 9005

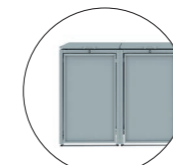

RAL 7045



RAL 7016\_WOOD



RAL 9005\_WOOD



RAL 7045\_WOOD



RAL 7016\_CORTEN



RAL 9005\_CORTEN

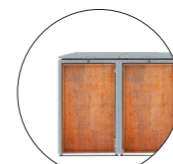

RAL 7045\_CORTEN



FRONT PERFORATION OPTION





## ParcelBOXY

ParcelBOXY are innovative home parcel lockers. Ordering online is now even more convenient thanks to our solution. In this way, freight shipments are safely stored! It's annoying if you're not at home when the courier arrives with the package. Instead of using public parcel machines, it is better to use your own solution. ParcelBOXES provide enough space for letters as well as medium-sized parcels. Our home parcel locker is equipped with a security lock, thanks to which your parcels are protected against access by third parties. In addition, the rainproof design can keep the items stored in the box dry on rainy days and save you from worry.

## FINISH OPTIONS



STEEL 7016    STEEL 9005    STEEL 7045    CORTEN    WOOD 7016    WOOD 9005    WOOD 7045



## DIMENSIONS

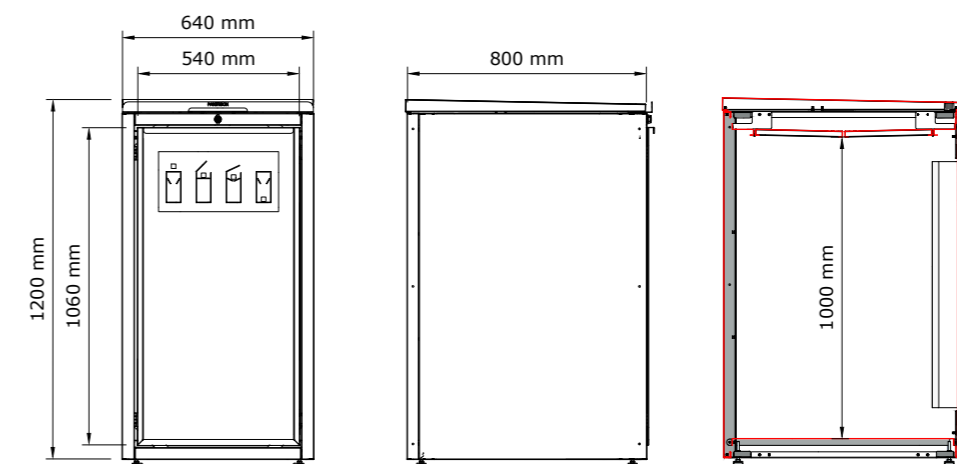



## FireBOXY

The modern and stylish garden fire pit is crafted from powder-coated galvanized steel, with its central section made of corten. This exceptional fire pit is designed to create a cozy and functional space for outdoor gatherings. Made from galvanized steel, the fire pit is not only durable but also weather-resistant, ensuring long-lasting use. But that's not all! The central section of the fire pit is constructed with corten, adding a unique charm and character to its design. Corten, a special type of steel, develops a natural, rustic patina over time when exposed to the elements, giving the fire pit a distinctive appearance. This eye-catching feature makes the fire pit not just a practical addition but also a stylish decorative element.

Furthermore, the fire pit is equipped with upholstered seats that are conveniently stored in a specially designed space beneath the fire pit. This innovative solution allows you to comfortably sit and enjoy the warmth of the fire, while the seats are safely stored, protected from the elements when not in use.

The size of the fire pit and the space beneath the seats are thoughtfully designed to provide comfort and ensure safety during use. The robust construction of the fire pit prevents the spread of fire, while the upholstered seats offer comfort for outdoor relaxation.

This modern and stylish garden fire pit is not only practical but also aesthetically pleasing. The combination of galvanized steel, corten, and upholstered seats creates a harmonious composition that adds elegance and allure to your garden or patio. You can invite family and friends for enjoyable evenings around the fire, making use of the comfortable seats and basking in the warmth of the flames.

## COLORS



RAL 7016



RAL 9005



RAL 7045



CORTEN

## Upholstery

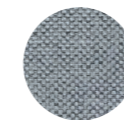

ALASKA



OAK

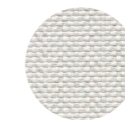

ARCTIC

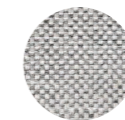

ASH

## DIMENSIONS

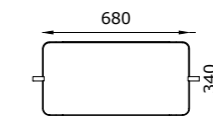
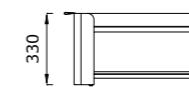
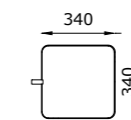
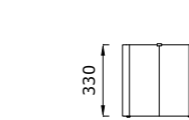
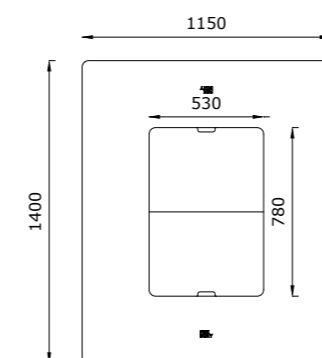
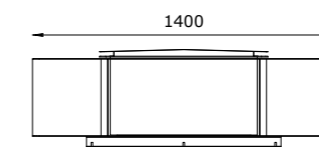
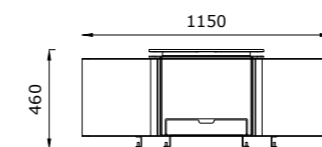



## GardenBOXY

The terrace and garden box is a modern solution made of high-quality galvanized steel, coated with powder paint. This material ensures durability and resistance to outdoor conditions such as rain and UV radiation. The box is stable and rigid, providing secure storage for various garden items.

Its main purpose is to store cushions and seat covers from outdoor sofas, as well as other garden accessories. With sufficient capacity, it offers a safe place to store these items, protecting them from moisture, dust, and dirt. The box provides protection against rain, keeping the cushions and seats dry. Additionally, the terrace and garden box is aesthetically pleasing and complements modern outdoor arrangements. The powder-coated finish gives it an elegant appearance while also protecting it from corrosion, allowing for long-term use. The box is stable and rigid, which means it can be used to hold other items or even serve as an additional seating option on the terrace.

In summary, the modern terrace and garden box made of galvanized steel, coated with powder paint, is an ideal solution for storing cushions, seat covers from outdoor sofas, and other garden items. Its solid construction ensures stability and durability, while the proper finish protects it from outdoor conditions. With this box, you can maintain order on your terrace or in your garden while preserving an aesthetic outdoor space.

## COLORS



RAL 7016



RAL 9005



RAL 7045



CORTEN

## DIMENSIONS

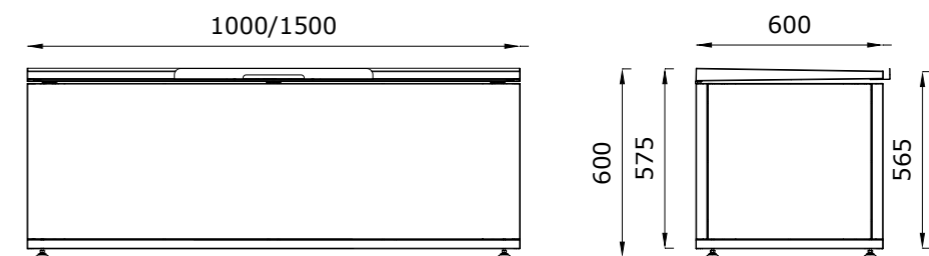





## GarageBOXY

The modern system of garage cabinets, wall panels, and shelves is made of powder-coated galvanized steel, resistant to moisture and temperature changes. This innovative modular system offers a variety of expansion and configuration possibilities. Constructed from galvanized steel and coated with a durable powder finish, this system is designed to withstand the challenges of garage environments. It is moisture-resistant and can handle fluctuations in temperature, ensuring its longevity and functionality. The system comprises garage cabinets that provide practical storage for tools, automotive accessories, and other items. The wall panels allow for hanging tools or objects, maximizing the available workspace. Additionally, shelves are available for storing smaller items or displaying collections.

One of the key advantages of this system is its modularity. It can be easily expanded and configured according to individual needs. Additional cabinets, wall panels, and shelves can be added as requirements evolve and change. This flexible approach allows for personalization and optimal utilization of the available space. Not only does this system provide practical storage solutions, but it also boasts a modern design that adds elegance and style to the garage or workshop. The use of galvanized steel with a powder-coated finish also ensures easy cleaning and maintenance, keeping the system in excellent condition for years to come.

The modern system of garage cabinets, wall panels, and shelves made of powder-coated galvanized steel is the perfect solution for those seeking practical, functional, and flexible storage solutions in their garage or workshop. With its expandability and configurability, this system allows for customization based on individual needs and preferences.

## COLORS



RAL 7016



RAL 9005



RAL 7045



CORTEN

## DIMENSIONS

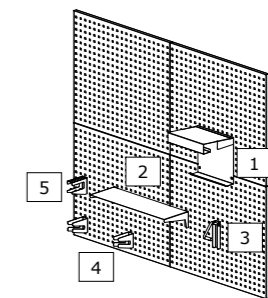
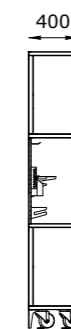
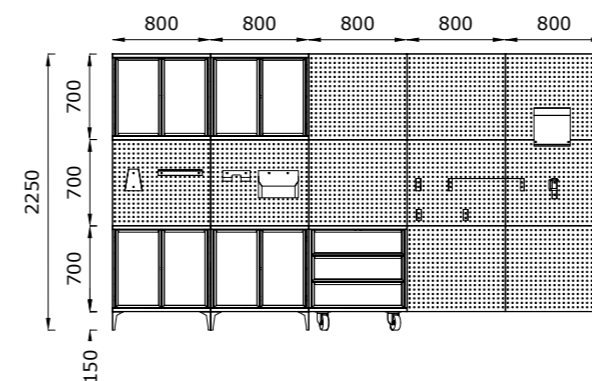

1. Shelf / bicycle hanger
2. Hanging shelf
3. Vertical bicycle hanger
4. Snowboard holders
5. Ski hanger





### KitchenBOXY

Our weatherproof steel garden kitchens are an excellent choice for people who want to enjoy the pleasure of cooking outdoors all year round. These kitchens are designed and made to withstand a variety of weather conditions, such as rain, snow and sunlight. They may include gas burners, grates, grills, ovens or sinks. Our outdoor kitchens often also have practical shelves, drawers or cabinets that allow you to keep kitchen accessories, dishes or spices within easy reach. Garden kitchens are also characterized by an attractive appearance. Steel is a modern material that gives the kitchen an elegant and stylish look, which blends perfectly with the garden environment. Some models of garden kitchens also offer additional personalization options, such as the choice of color or design, so you can match them to your individual taste and style of garden design.

### COLOR

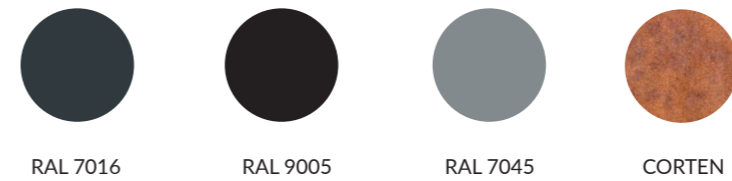

### Compact 12mm HPL laminate

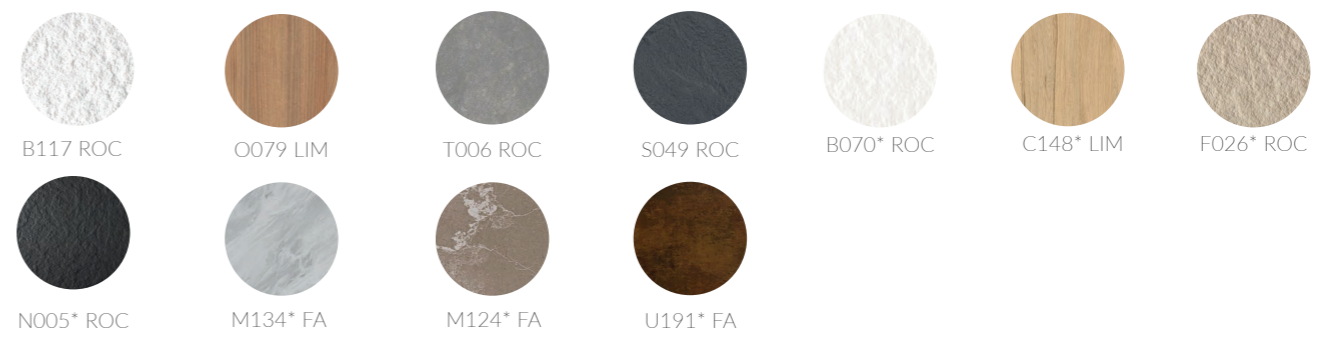

### DIMENSIONS

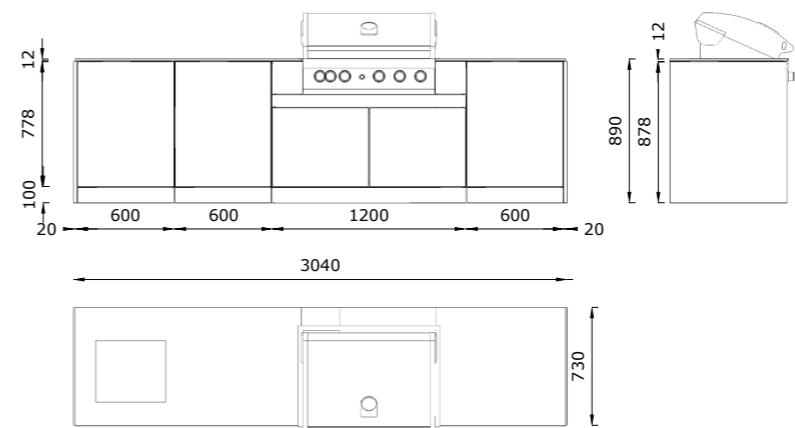

Distributor:

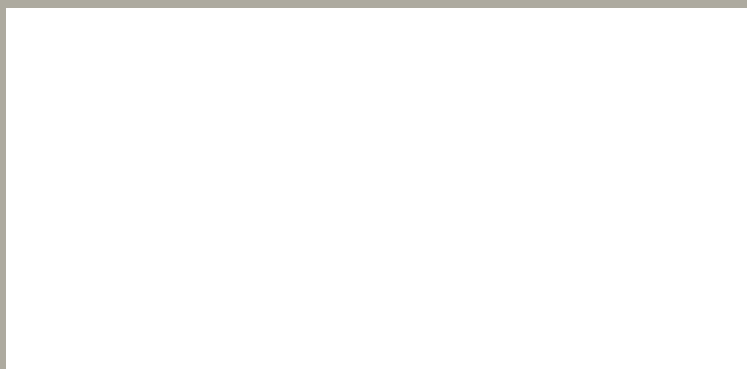

**SMART  
BOXY**

SMART BOXY  
Wedrowcow 112  
43-300 Bielsko-Biala  
T:+44 208 333 050  
info@smartboxy.eu  
www.smartboxy.eu