

## JSC-02N-XXXX-100mA SERIES

JSC series of split-core current transformer offers 333mV at secondary from sensed primary current. Without using secondary CT inside of meter, users directly connect JSC series to a meter for high accuracy metering application. It enables one meter to be adopted for various current rating by only changing primary CT so it makes compact design meter and reduces developing cost. Also, over-voltage protection circuit is included to offer safe, fast and cost effective installation.



### Advantages

- IEEE/ANSI C57.13, Class 0.3/0.6 accuracy
- IEC 61869-2 Class 0.2S/0.5S accuracy
- Accessories options for installation (Terminal, plug-in, RJ12 port)

### Application

- ANSI C12.20 of class 0.5
- IEC 62053-22 of class 0.5S
- IEC 61000-4-30 A ED3 for Power Quality Meter

### Standards

- UL Listed UL2808 (XOBA) : Pollution Degree: 3 CAT IV, 600 Vac
- UL/EN61010-1(PICQ) : Pollution Degree: 3 CAT IV, 600 Vac



Model	Rated Amps	Output	Accuracy	Internal Burden (Ohms)
JSC-02N-0400-100mA	400A	100mA	0.5%	3Ω
JSC-02N-0600-100mA	600A	100mA	0.5%	3Ω
JSC-02N-0800-100mA	800A	100mA	0.5%	3Ω
JSC-02N-1000-100mA	1000A	100mA	0.5%	3Ω
JSC-02N-1200-100mA	1200A	100mA	0.5%	3Ω

Note: the burden resistor is built into the JSC-02N-XXXX-333mV SERIES.

### How to Use

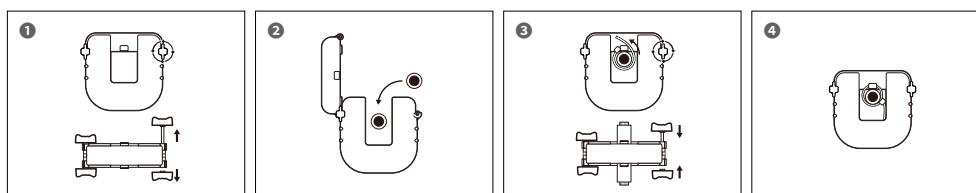

Please refer to "Split-core Current Transformer Installation Guide" for further details.

## 1. Specifications

- Accuracy : Class 0.5S
- System Voltage : 720 V (0.72 kV)
- Overload Withstand : 1.2 times rated current continuously
- Compliant with : IEC/EN 61869-2 & IEC 61010-1
- Operating Temperature Range : -20°C to 60°C
- Relative Humidity : 0 to 85% non-condensing
- Test Voltage : 3 kV for 1 minute
- Frequency Range : 50/60 Hz
- Protection Level : 3.0V0-P
- Insulation Category : CAT III 600 Vac

### 1.1 Accuracy

- Ratio Error :  
Accuracy 0.5% conforms to IEC 61869-2 & IEEE/ANSI C57.13 meets the measuring range from 1% to 120% of  $I_n$
- Phase Angle :  
50/60 Hz – 0.0 to 2.0 degrees leading from 1% to 120% of rated current

### Position Sensitivity

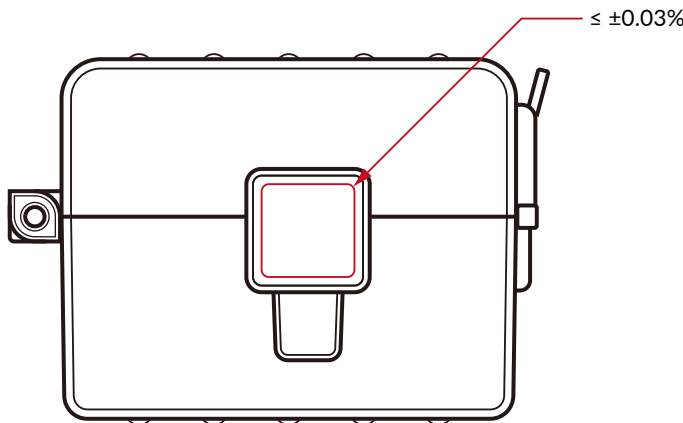

### Shock and Air Gap Test

▪ Shock and Vibration Test Report(JPS10)

100A	
Phase error(°)	Linearity Error(%)
0.21	- 0.15
0.23	- 0.16



100A	
Phase error(°)	Linearity Error(%)
0.21	- 0.17
0.22	- 0.18

▪ Core Air Gap Test Report(JPS10)

100A	
Air gap : 2microns	
Phase error(°)	Linearity Error(%)
0.21	- 0.15



100A	
Air gap : 2.5microns	
Phase error(°)	Linearity Error(%)
0.21	- 0.17

**1.2 Regulatory**

- CE
- UL Listed UL2808 (XOBA) : Pollution Degree: 3 CAT IV, 600 Vac
- UL/EN61010-1(PICQ) : Pollution Degree: 3 CAT IV, 600 Vac
- RoHs Compliant

**1.3 Environmental**

- **Operating Temperature** : -40°C to 70°C (-40°F to +158°F)
- **Operating Humidity** : Non-condensing, 0 to 95% relative humidity(RH)
- **Operating Altitude** : Up to 3000 m (9842 feet)
- **Pollution Degree** : 3 (harsh environment)
- **Indoor Use** : Suitable for indoor use
- **Outdoor Use** : Suitable for outdoor use when mounted in a NEMA 3R or 4 (IP 66) rated enclosure, provided the ambient temperature will not exceed 55°C (131°F)

**1.4 Mechanical**

- **Width** : 122mm
- **Height** : 128mm
- **Thickness** : 29mm
- **Opening** : 10mm
- **Weight** : 700g
- **Core Nickel Core** : high permeability ferrite
- **Standard lead wire** : 2.44m, 18AWG

(mm)

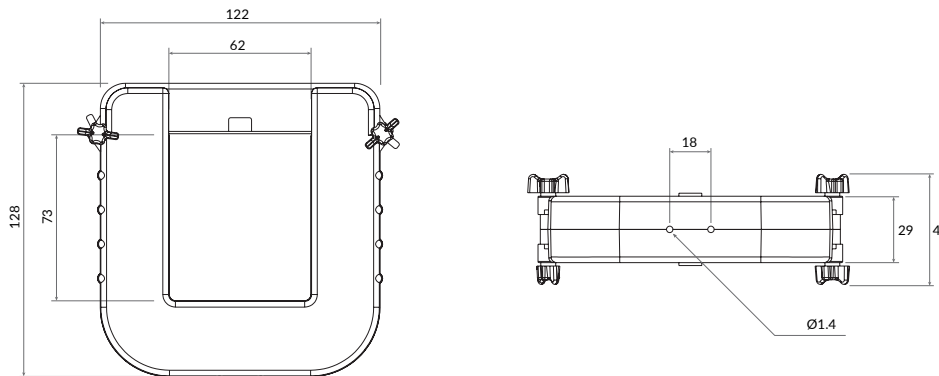

**1.5 Labels**

**Front Label**

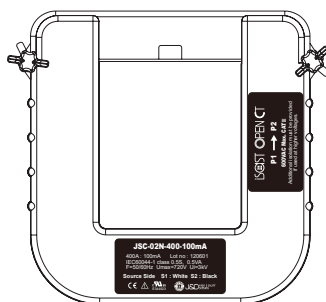

- **QR code** : <Model> ; <SerialNum> ; Scan QR code for Instruction Manual
- **Orientation** : Mount the CT referring to the right side label attached(P1->P2).

## 2. Typical Accuracy

- In the following graphs, a positive phase angle error indicates that the output of the CT leads the primary current.
- Graphs show typical performance at 25°C, 60 Hz
- Performance Graphs - The standard CT meets ANSI/IEEE C57.13 class 1.2 standard & IEC 61869-2 class 1.0 standard

### 2.1 Schematic Diagram

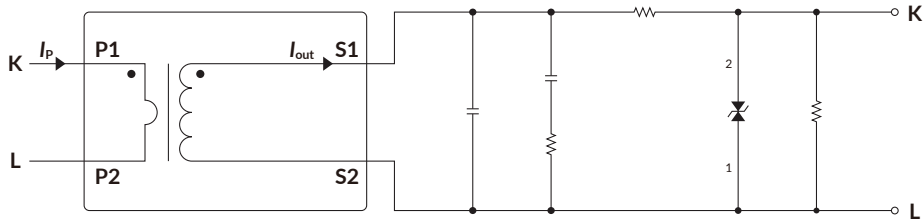

### 2.2 JSC-02N-0400-100mA

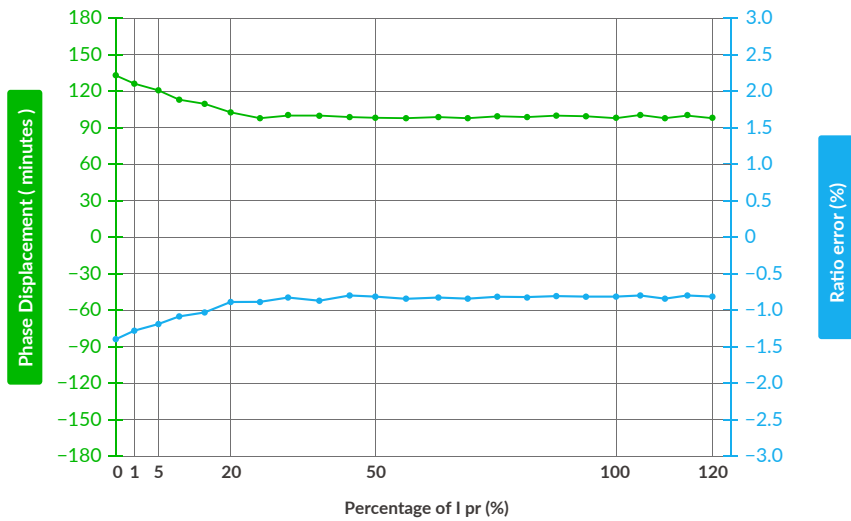

### 2.3 JSC-02N-0600-100mA

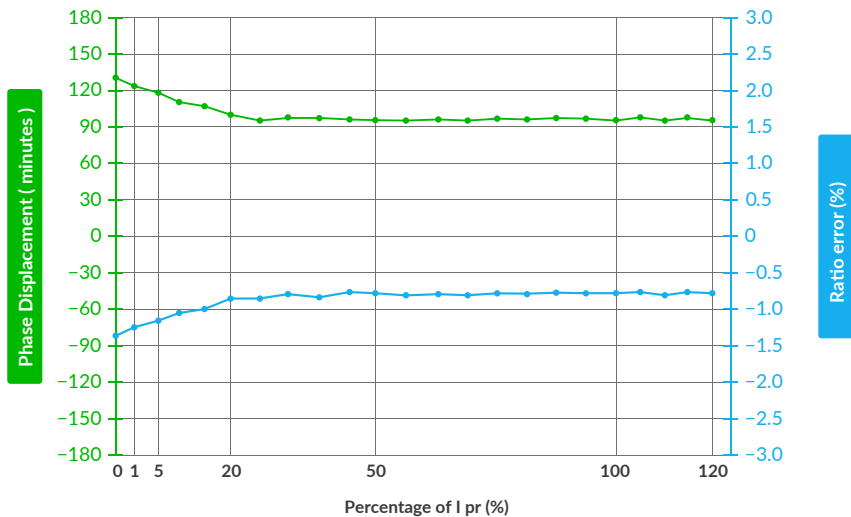

2.4 JSC-02N-0800-100mA

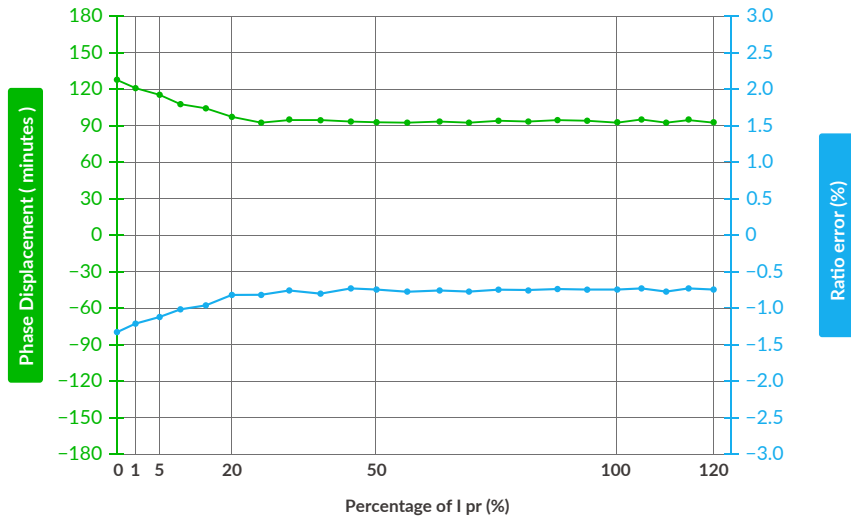

2.5 JSC-02N-1000-100mA

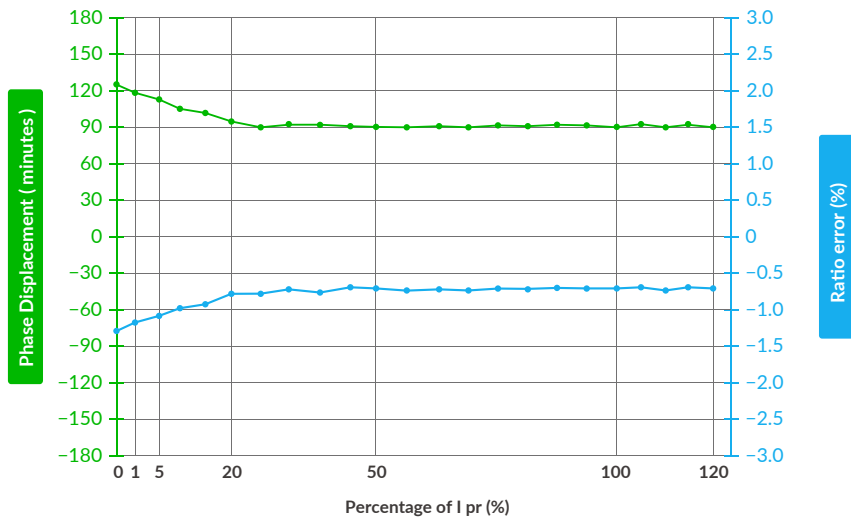

2.6 JSC-02N-1200-100mA

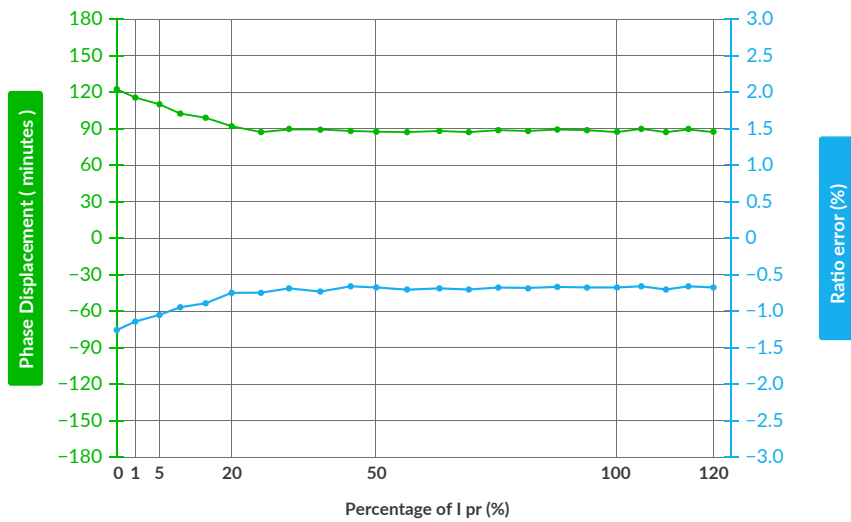

### 3. Safety Notes



Caution : Danger



HAZARD OF ELECTRIC SHOCK, EXPLOSION, OR ARC FLASH

- In order to guarantee safe operation of the transformer, please read and understand the instructions thoroughly. For your reference, see NFPA 70E in the USA, or applicable local codes.
- Before servicing the CTs, turn off all sources of power and use a properly rated voltage sensing device to check if the power is off.
- Current transformer secondary must be shorted or connected to a burden all times.
- The transformer (split core type) must not be operated when it is not fully closed or the installation is not completed.
- Rearrange all covers and protective devices before powering the equipment.
- A qualified person is the one who is skilled and has knowledge about the construction and operation of this electrical equipment, and has received safety training to recognize and avoid the hazards involved. (NEC2011 Article 100)



Notice

- If you impact the core surface, internal core material could be damaged.
- Customizing output lead wire
- This product is not intentionally made for safety applications.
- Make sure not to install this transformer in hazardous or classified areas.
- The installer is responsible for conformance to all applicable codes.
- Ignoring the warnings can lead to serious injury and/or cause damages.
- If this product is used in a way not specified by the manufacturer, the protection offered by the product may be impaired. No responsibility is taken by J&D Electronics for any consequences arising by not following this material properly.