

Current Transformers JPS33N-XXXX-100mA SERIES

The JPS series of split core current transformers is designed for easy and efficient installation, making them ideal for use in both new construction and retrofit applications. The split core design enables quick and simple installation by allowing the CT to be easily opened and placed around the power cable. The JPS series also features enhanced durability, making them resistant to the effects of vibration and shock.

The JPS series of CTs can accurately measure the current flowing through the power line with Revenue grade accuracy. This makes them suitable for use in Power Quality measuring and Revenue Grade metering applications. The unique design of the JPS series is listed under UL 2808 and UL/EN 61010-1, allowing for field installation of the CT in manufactured subpanels and electrical cabinets while maintaining the UL rating and manufacturer warranty. In addition, the JPS series CTs feature a secure locking mechanism that is noticed by a single click sound. This ensures that the CTs remain firmly in place and do not shift or move, providing accurate and reliable current measurement. Overall, the JPS series of split core current transformers offers a convenient and effective solution for current measurement in a variety of applications.

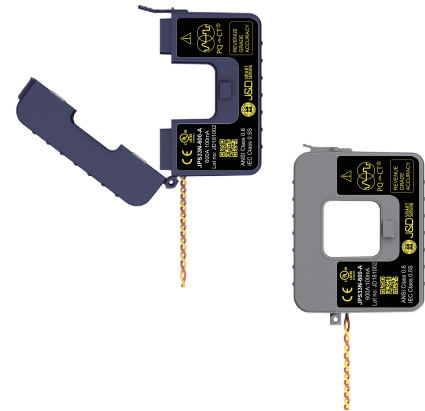

Advantages

- IEEE/ANSI C57.13, Class 0.3/0.6 accuracy
- IEC 61869-2 Class 0.2S/0.5S accuracy
- Accessories options for installation (Terminal, plug-in, RJ12 port)

Application

- ANSI C12.20 of class 0.2/0.5
- IEC 62053-22 of class 0.2S/0.5S
- IEC 61000-4-30 A ED3 for Power Quality Meter

Standards

- UL Listed UL2808 (XOBA) : Pollution Degree: 3 CAT IV, 600 Vac
- UL/EN61010-1(PICQ) : Pollution Degree: 3 CAT IV, 600 Vac

Model	Rated Amps	Output	Accuracy	Internal Burden (Ohms)
JPS33N-250-100mA	250A	100mA	0.2/0.5%	47.4 Ω
JPS33N-300-100mA	300A	100mA	0.2/0.5%	68.2 Ω
JPS33N-400-100mA	400A	100mA	0.2/0.5%	116.6 Ω
JPS33N-500-100mA	500A	100mA	0.2/0.5%	162 Ω
JPS33N-600-100mA	600A	100mA	0.2/0.5%	237 Ω

How to Use

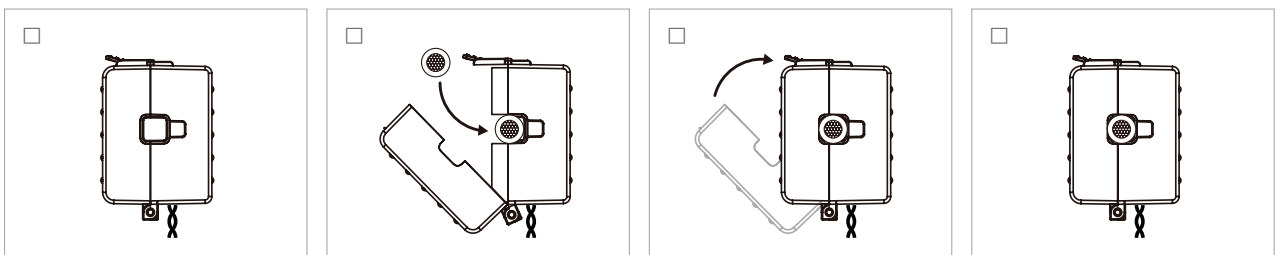

Please refer to "Split-core Current Transformer Installation Guide" for further details.

1. Specifications

- Accuracy : Class 0.5S
- System Voltage : 720 V (0.72 kV)
- Overload Withstand : 1.2 times rated current continuously
- Compliant with : IEC/EN 61869-2 & IEEE/ANSI C57.13
- Operating Temperature Range : -40°C to 70°C
- Relative Humidity : 0 to 90% non-condensing
- Test Voltage : 3 kV for 1 minute
- Frequency Range : 50/60 Hz
- Protection Level : 3.0V0-P
- Insulation Category : CAT III 1000 Vac, CAT IV 600 Vac
- Output Lead Wires :
 Style : Two conductor, brown and yellow twisted pair (equivalent to about one #8 AWG 0.213" dia.), MTW, UL 1015
 Standard length : 8 ft (2.44m), Gauge : #18 AWG, Voltage : 600Vac

1.1 Accuracy

- Ratio Error :
 Accuracy 0.5% conforms to IEC 61869-2 & IEEE/ANSI C57.13 meets the measuring range from 1% to 120% of I_n
- Phase Angle :
 50/60 Hz - 0.0 to 2.0 degrees leading from 1% to 120% of rated current

Position Sensitivity

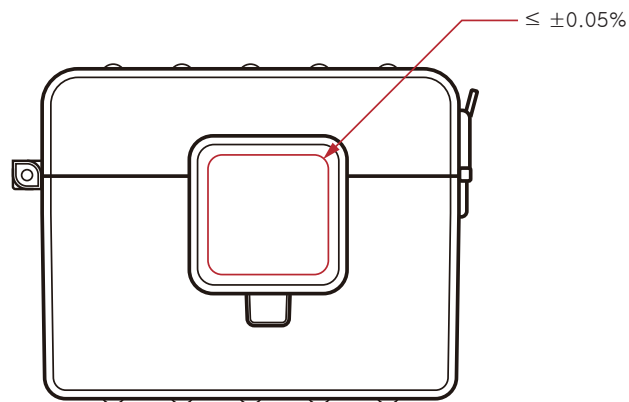

Shock and Air Gap Test

- Shock and Vibration Test Report(JPS33)

400A	
Phase error(°)	Linearity Error(%)
0.20	- 0.16
0.22	- 0.15



400A	
Phase error(°)	Linearity Error(%)
0.20	- 0.16
0.21	- 0.17

- Core Air Gap Test Report(JPS33)

400A	
Air gap : 2microns	
Phase error(°)	Linearity Error(%)
0.20	- 0.14



400A	
Air gap : 2.5microns	
Phase error(°)	Linearity Error(%)
0.22	- 0.18

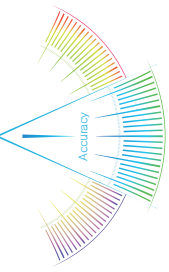

Harmonic Graphs

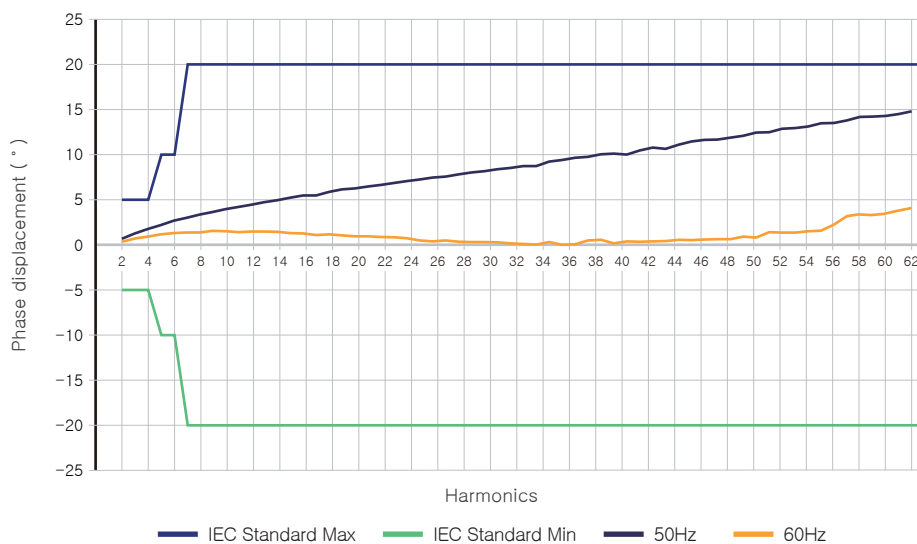
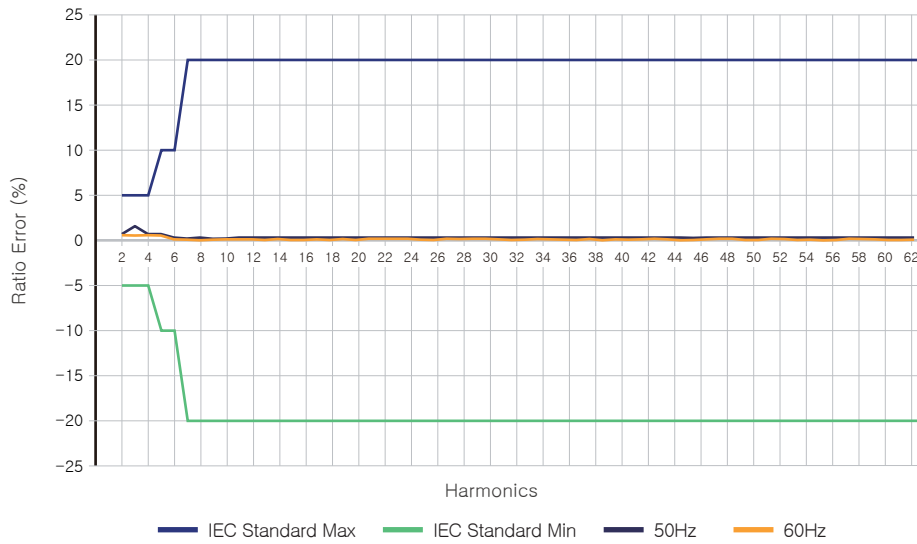

1.2 Regulatory

- CE
- UL Listed UL2808 (XOBA) : Pollution Degree: 3 CAT IV, 600 Vac
- UL/EN61010-1(PICQ) : Pollution Degree: 3 CAT IV, 600 Vac
- RoHs Compliant

1.3 Environmental

- Operating Temperature : -40°C to 70°C (-40°F to +158°F)
- Operating Humidity : Non-condensing, 0 to 95% relative humidity(RH)
- Operating Altitude : Up to 3000 m (9842 feet)
- Pollution Degree : 3 (harsh environment)
- Indoor Use : Suitable for indoor use
- Outdoor Use : Suitable for outdoor use when mounted in a NEMA 3R or 4 (IP 66) rated enclosure, provided the ambient temperature will not exceed 55°C (131°F)

1.4 Mechanical

- Width : 96mm
- Height : 77.5mm
- Thickness : 36mm
- Opening : 33mm
- Weight : 590g
- Core Nickel Core : high permeability ferrite
- Standard lead wire : 2.44m, 18AWG

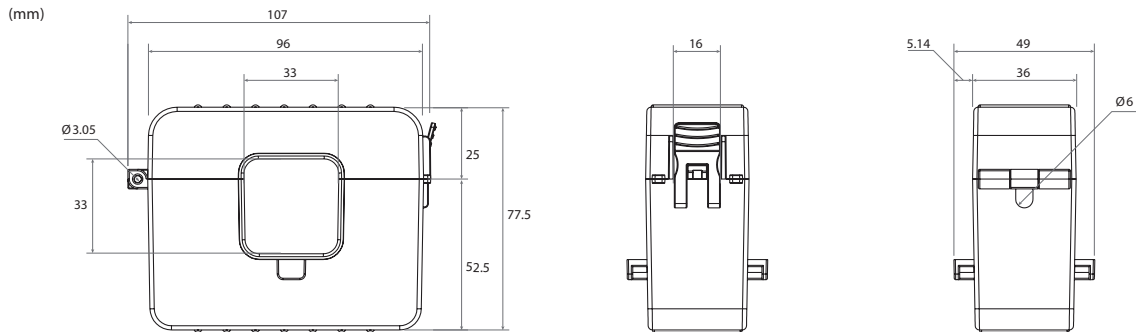

1.5 Labels

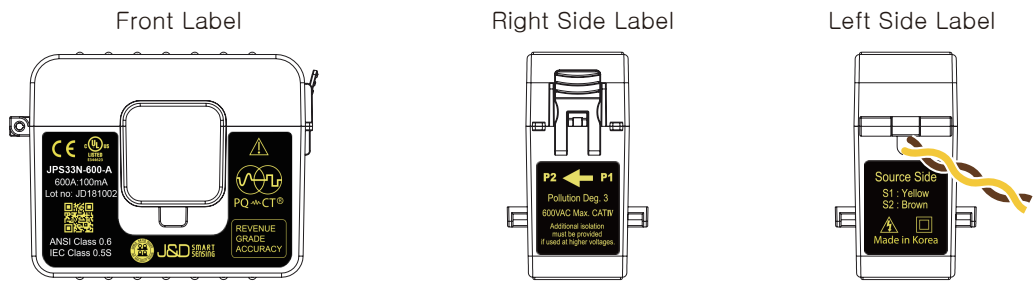

- QR code : <Model> ; <SerialNum> ; Scan QR code for Instruction Manual
- Orientation : Mount the CT referring to the right side label attached(P1→P2).

2. Typical Accuracy

- In the following graphs, a positive phase angle error indicates that the output of the CT leads the primary current.
- Graphs show typical performance at 25°C, 60 Hz
- Performance Graphs – The standard CT meets ANSI/IEEE C57.13 class 0.6 standard & IEC 61869-2 standard class 0.5

2.1 Schematic Diagram

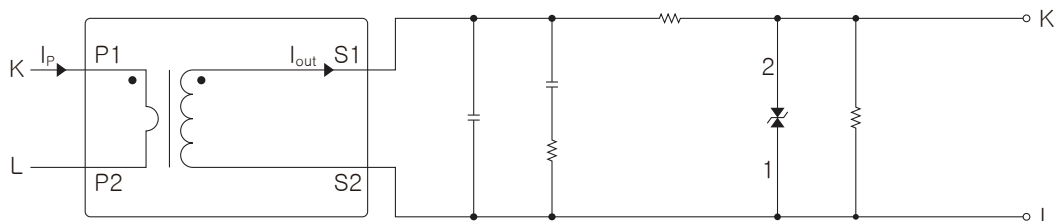

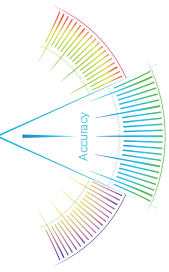

2.2 JPS33N-250-100mA

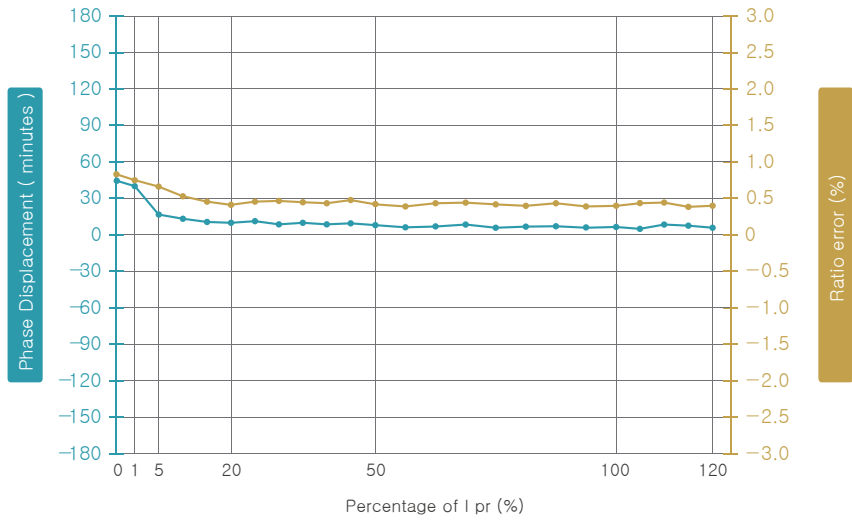

2.3 JPS33N-300-100mA

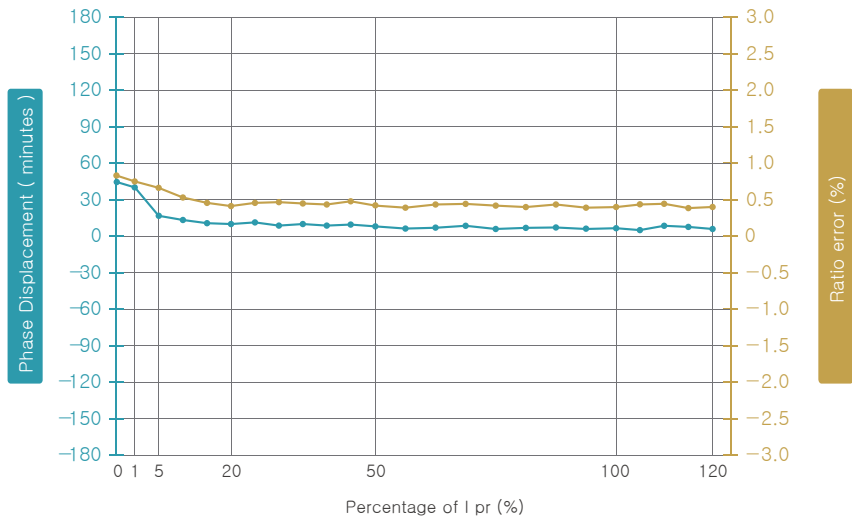

2.4 JPS33N-400-100mA

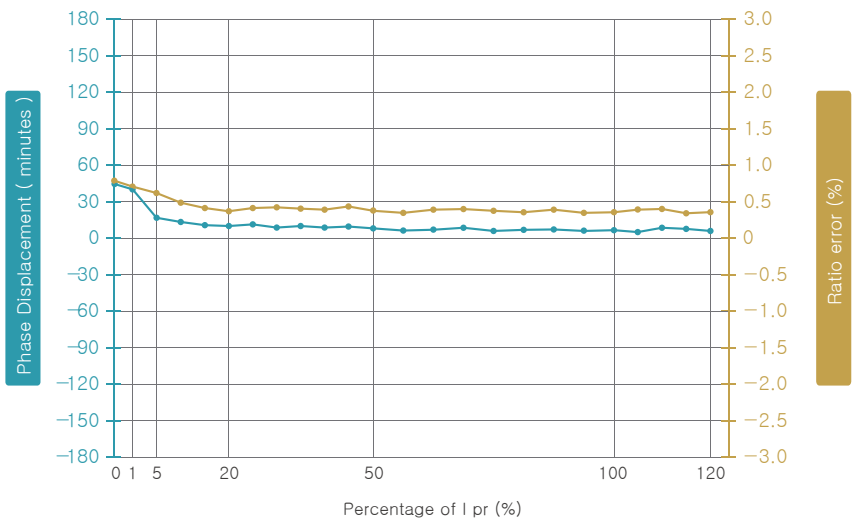

2.5 JPS33N-500-100mA

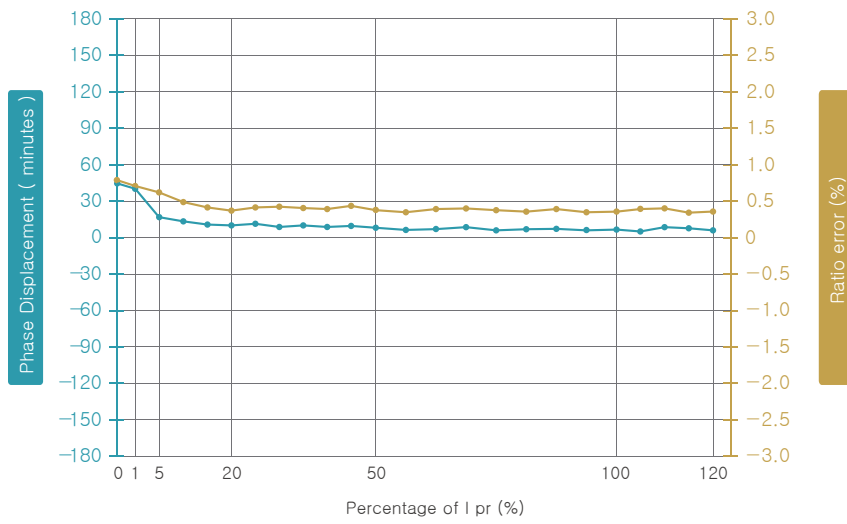

2.6 JPS33N-600-100mA

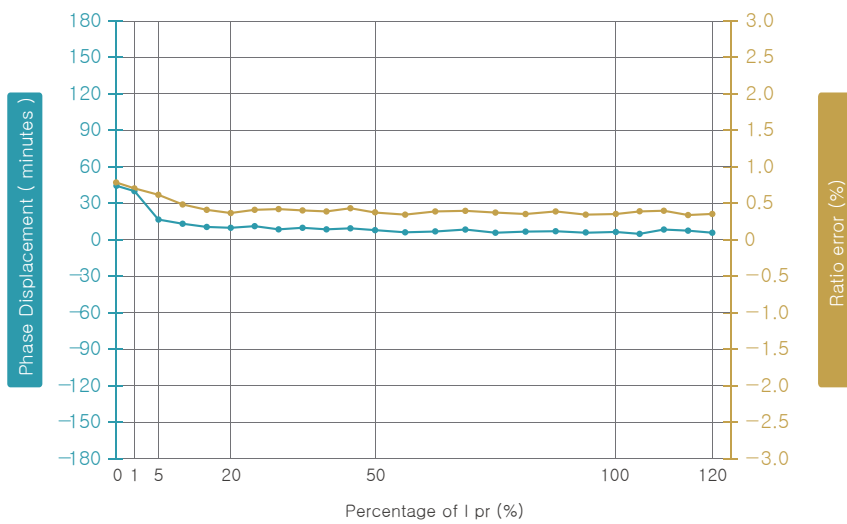

Safety Guide

Safety

The J&D CTs are UL2808 Listed, UL/EN 61010-1, CE, RoHS compliant and certified, are also conformed up to Pollution degree 3, 600Vac CAT IV rated devices.



Please be sure that Failure to follow these instructions can result in serious injury and/or cause damage.

The transformer shall be used in electric/electronic equipment in accordance with the operating instructions of all related systems and component manufacturers with respect to applicable standards and safety requirements.

Follow corresponding national regulations and safe electrical work practices.

This equipment must only be installed and serviced by qualified personnel. And the qualified personnel are those who has skills and knowledge related to the construction and operation of this electrical equipment and installations, and has received safety training to recognize and avoid potential hazards.



When operating the transformer, there may be dangerous active voltages (e.g. primary conductor) in certain parts of the module. Users should make sure to take all necessary steps to protect against electric shock. The transformer is a built-in device containing conductive parts that are inaccessible after installation. Therefore, a protective enclosure or additional insulation barrier is necessary.

Safe and trouble-free operation of this converter can only be guaranteed if transport, storage and installation are carried out correctly and operation and maintenance are carried out carefully.

Remark

- V_o is positive when I_p flows in the direction of the arrow. (o : output, p : primary current)
- Temperature of the primary conductor should not exceed 80°C(176°F).
- Dynamic performances (di/dt and delay time) are the best with a single bar when the primary hole is completely filled.

Attention

Contact areas (air gap) must be kept clean (particle free) to ensure proper performance

Warning



This product can expose you to chemicals including Antimony Trioxide, which is known to the State of California to cause cancer. For more information go to: www.P65Warnings.ca.gov