

Split-Core Current Transducer

JM21FA-XXX-RMS

The JM21FA-RMS series is a split core current transducer for electronic measurement of AC waveform current with galvanic separation between the primary AC current circuit and the secondary 4-20mADC output circuit.



Applications

- Remote control of current measurement distributed PLC for processes in SCADA systems,
- Load trend of monitor critical motor (compressor, fuel, etc.) and other loads up to 250A.
- Convenient connection to power consumption submeter for energy monitoring.

Features

- RMS output
- Loop-powered 4-20mADC current output
- $\varnothing 21$ mm sensing aperture for non-contact measurement
- Nylon-spring, output-terminal, secure locking hinge, one-touch structure make it easy to install to the existent equipment such as a power distribution board.
- Isolated plastic case recognized according to UL94-V0
- UL/EN 61010-1 certified

Benefits

- Compact and lightweight design Easy to install in confined spaces.
- It is a split type, and the installation cost is reduced through easy, fast and simple installation.
- Convenient connection to power consumption submeter for energy monitoring.

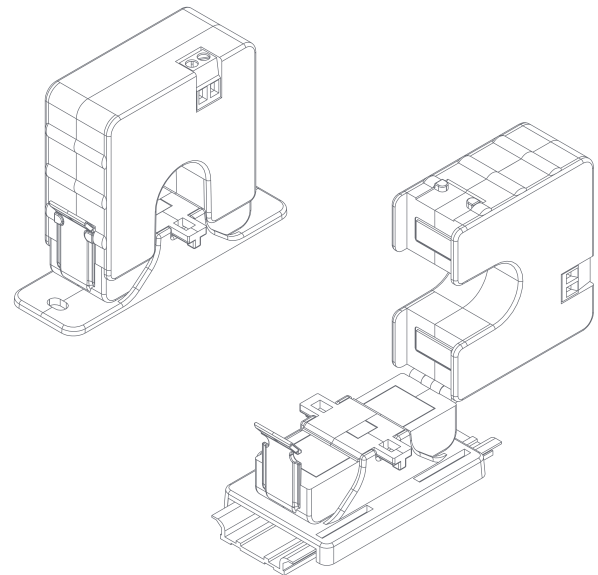

Notice

- This product is not intended for life or safety applications.
- Do not install this product in hazardous or classified locations.
- The installer is responsible for conformance to all applicable codes.
- Mount this product inside a suitable fire and electrical enclosure.
- If you impact the core contact surface, internal core material could be damaged.
- Please use only the original output screws. Not recommended to replace it with anything else.
- Clean the contact surface and make sure to remove all debris on the contact parts.
- Be careful of damaging or breaking the core.

Specification

(F=50/60Hz)

Model	JM21FA-XXX-RMS			
Rating current	5, 10, 20 (Arms)	25, 50 (Arms)	75, 100, 150 (Arms)	200, 250 (Arms)
Output current	4~20mADC/from zero to rated current (Recommended load resistor $\leq 600\Omega$ / at power supply 24V)			
Power supply	Single power supply(24V)			
Maximum current	120%(continuous), 150%(1min)			
Accuracy	<2% of nominal primary Current			
Response time	100ms (typ)			
Output ripple	Within 5% of output			
Withstand voltage	AC3500V(50/60Hz), 1min (between core and output terminal in a lump)			
Insulation Resistance	DC500V, $\geq 100M\Omega$ (between core and output terminal in a lump)			
Operating temperature	-20°C~ +50°C, $\leq 80\%RH$, no condensation, for indoor assembly, free direction for setting			
Storage temperature	-30°C~ +90°C, $\leq 85\%RH$, no condensation			
Fitting repeatability	≈ 100 times			
Output terminal	2XM3 screw terminal and with terminal cover			
Screw torque	0.3N · m			
Mass	approximately 75g			

Internal Circuit Drawings

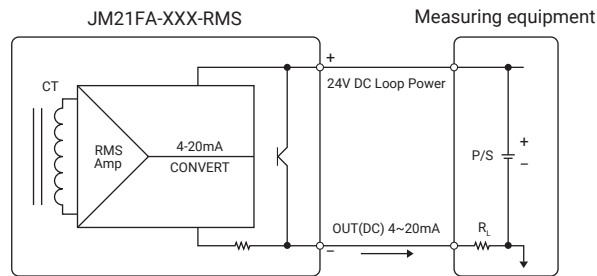

2-Wire Transmission method(Loop powered) using P/S(+ side) of Measuring equipment

Output Ampere Data

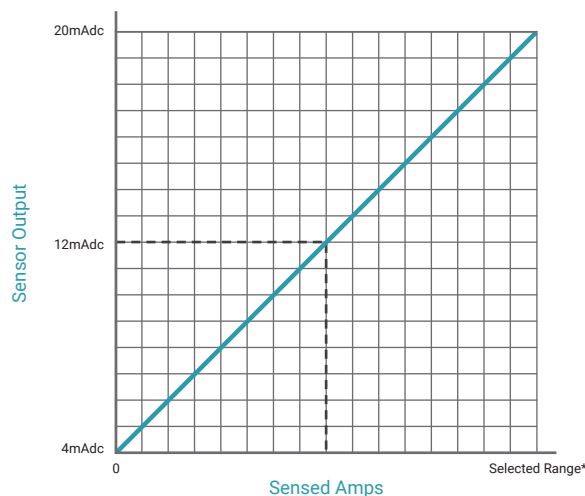

*Factory calibrated ranges selected with the amperage range switch

Dimensions

(Unit: mm)

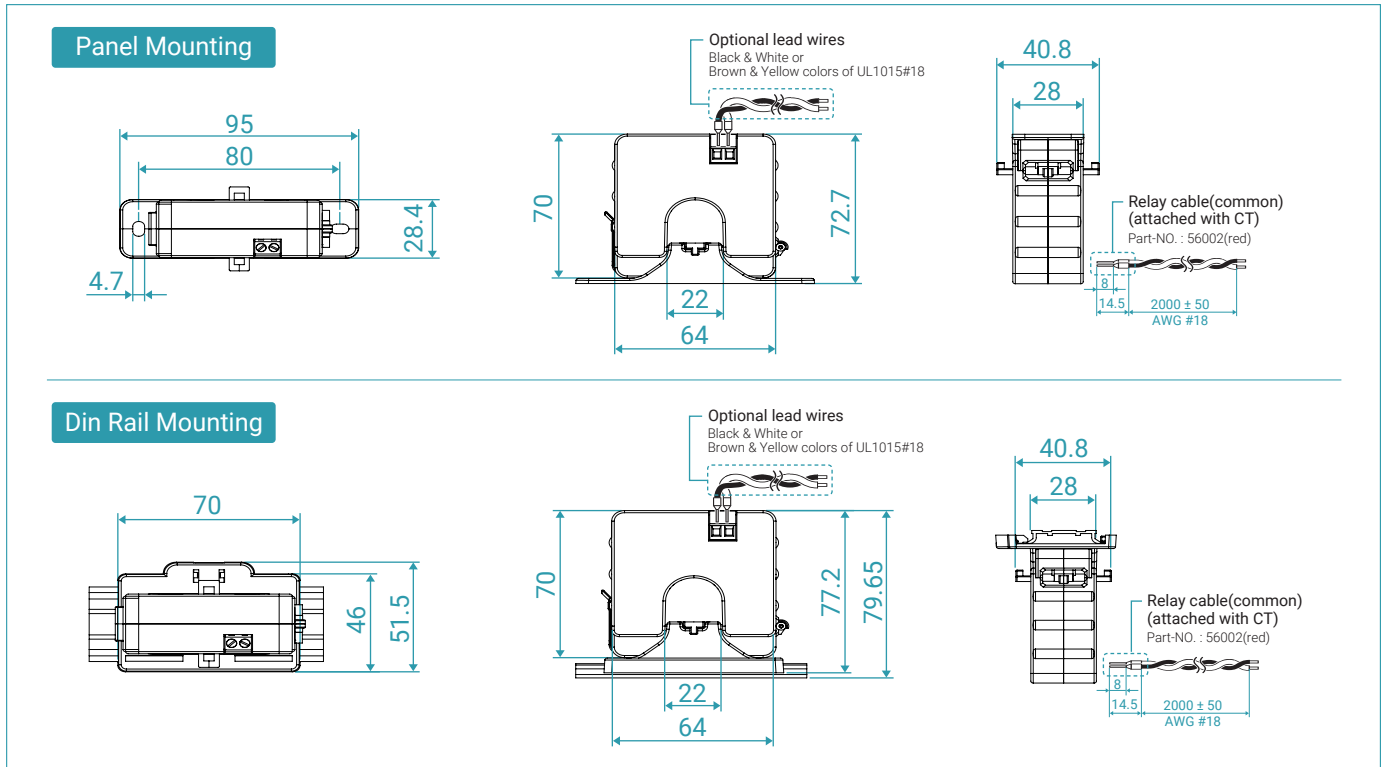

Installation

Disconnect and lock out power to the enclosure containing the conductor to be monitored.

- 1 The cables passing through the primary current must be insulated cables. Choose a location for the sensor. The monitored conductor must pass.
- 2 Wire the output connections between the sensor and the controller (4-20mADC).
- 3 Check the inner diameter of the sensor to be installed and the outer diameter of the cable. Snap the sensor over the conductor to be monitored. And secure with cable ties.
- 4 Secure the enclosure and reconnect power.

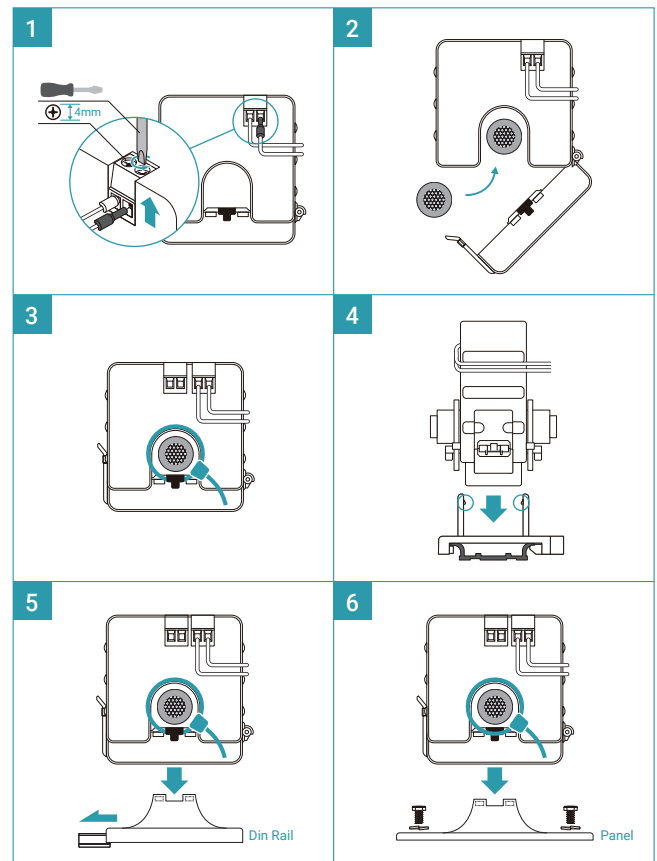
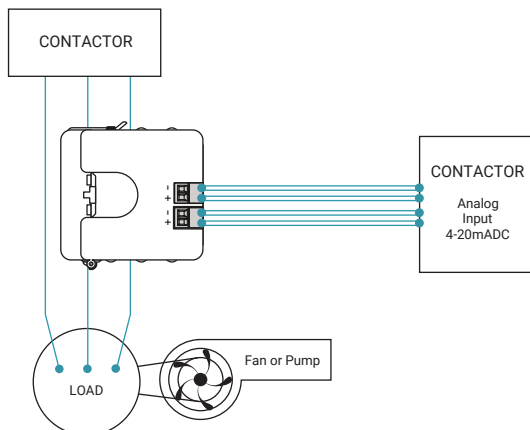

Accessory Option

Panel Mounting

Tighten screws on the hole to mount bracket and install current transformer

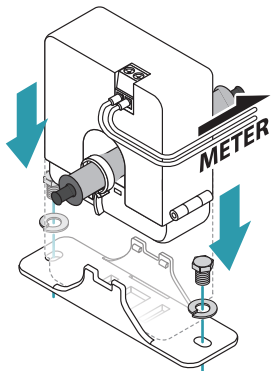

• Dimensions (unit: mm)

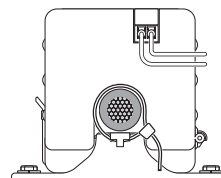
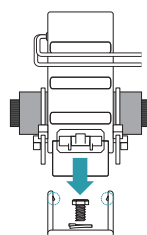
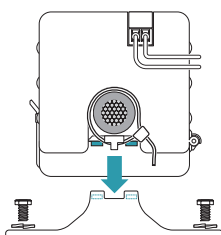
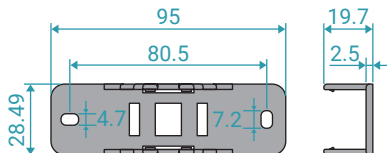

Din Rail Mounting

Mount the bracket on the rail and install current transformer

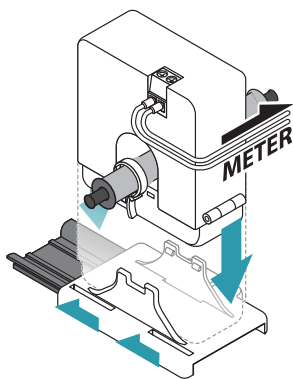

• Dimensions (unit: mm)

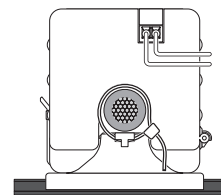
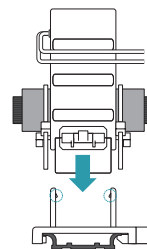
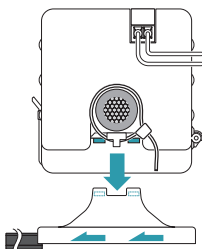
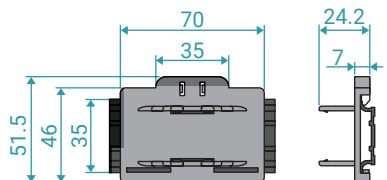

SAFETY & DANGER NOTES



The J&D CTs are UL/EN 61010-1, CE, RoHS 3 compliant and certified, are also conformed up to Pollution degree 2, 600Vac CAT III rated devices. *The transducer shall be used in electric/ electronic equipment in accordance with the operating instructions of all related systems and component manufacturers with respect to applicable standards and safety requirements.

- Follow corresponding national regulations and safe electrical work practices. See NFPA 70E in the USA, or applicable local codes.
- This equipment must only be installed and serviced by qualified electrical personnel. A qualified person is one who has skills and knowledge related to the construction and operation of this electrical equipment and the installation and has received safety training to recognize and avoid the hazards involved.
- When operating the transducer, there may be dangerous active voltages (e.g. primary conductor) in certain parts of the module. Users should make sure to take all necessary steps to protect against electric shock.
The transducer is a built-in device containing conductive parts that are inaccessible after installation. Therefore, a protective enclosure or additional insulation barrier is necessary.
Safe and trouble-free operation of this converter can only be guaranteed if transport, storage and installation are carried out correctly and operation and maintenance are carried out carefully.
- Read, understand, and follow the instructions before installing this product. Please be sure that Failure to follow these instructions can result in serious injury and/or cause damage.
- Turn off all power supplying equipment before working on or inside the equipment.
- Use a properly rated voltage sensing device to confirm power is off.
DO NOT DEPEND ON THIS PRODUCT FOR VOLTAGE INDICATION.
Only install this product on insulated conductors. Failure to follow these instructions will result in death or serious injury.
- NEC2009 Article 100.
No responsibility is assumed by J&D for any consequences arising out of the use of this material.

REMARK

- V_o is positive when IP flows in the direction of the arrow. (o : output, p : primary current)
- Temperature of the primary conductor should not exceed 50°C(122°F)
- Dynamic performances (di/dt and delay time) are the best with a single bar when the primary ole is completely filled.
- By hysteresis of core, offset drift occurs proportionally to the over-current higher than rating value.
- The output value fluctuates upon the various factors, so it is recommended to use the current range higher than 5% of the rated current.
- Do not use the product over the maximum current continuously.

ATTENTION

- J&D reserves the right to revise the data sheet without prior notice to improve product haracteristics.