

## JC24F-XXX-333mV SERIES

JC series of split-core current transformer offers 333mV at secondary from sensed primary current. Without using secondary CT inside of meter, users directly connect JC series to meter for high accuracy metering application. It enables one meter to be adopted for various current rating by only changing primary CT so it makes compact meter design and reduces developing cost. Also, over-voltage protection circuit is included to offer safe, fast and cost effective installation.

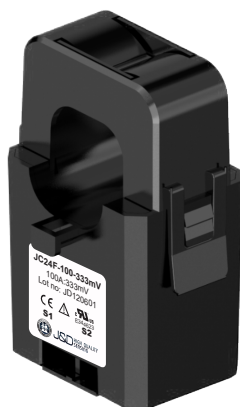

### Applications

- Energy sub - meter
- Power meters
- Power quality monitoring
- HVAC&Pumps, etc
- Distributed measurement system

### Benefits

- Small-size, light-weight
- Simple Installation
- Over-Voltage protection circuit is installed.

### Features

- High accuracy : 1% from 10% to 120% of rated current
- Nylon-spring, output-terminal, secure locking hinge, one-touch structure makes easy to install to the existent equipments such as a power distribution boards.
- Isolated plastic case recognized according to UL94-V0
- UL / EN 61010-1 certified

### Notice

- If you impact the core contact surface, internal core material could be damaged. (Ø10, Ø16, Ø24 type)
- Core contact surface is waterproofed, however if it gets rusty, you could reuse after removing rusts with spraying WD-40 or CRC5-56 on the rusted side.(Ø36 type)
- Do not use any other chemicals except WD-40 or CRC5-56 on housing or any other parts.
- Please use only the original output screws. Not recommended to replace it with anything else.
- Customizing output lead wire

Model	Rated Amps	Output	Accuracy	Internal Burden (Ohms)	DCR
JC24F-005-333mV	5A	333mV	1.0%	3.3Ω	201Ω
JC24F-010-333mV	10A	333mV	1.0%	3.3Ω	100Ω
JC24F-030-333mV	30A	333mV	1.0%	3.3Ω	
JC24F-050-333mV	50A	333mV	1.0%	3.3Ω	
JC24F-070-333mV	70A	333mV	1.0%	3.3Ω	
JC24F-100-333mV	100A	333mV	1.0%	3.3Ω	
JC24F-150-333mV	150A	333mV	1.0%	3.3Ω	
JC24F-200-333mV	200A	333mV	1.0%	3.3Ω	

Note: the burden resistor is built into the JC24F-XXX-333mV SERIES.

### How to Use

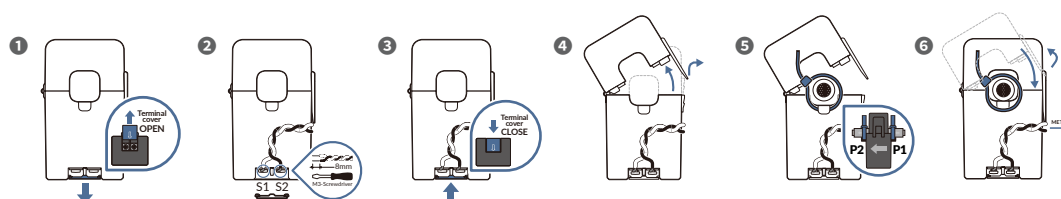

## 1. Specifications

- Amperage Range : 5, 10, 30, 50, 70, 100, 150, 200
- Output Voltage : 333mV
- Nominal Phase Angle Error :  $+1.0 \pm 1^\circ$
- Nominal Linearity Error :  $-1 \pm 1\%$
- Insulation Category : CATIII
- Operating Condition :  $-20^\circ\text{C} \sim +50^\circ\text{C}$ ,  $\leq 85\% \text{RH}$ , No condensation, In-house & Any direction installable
- Storage Condition :  $-30^\circ\text{C} \sim +90^\circ\text{C}$ ,  $\leq 85\% \text{RH}$ , No condensation

### 1.1 Accuracy

- Ratio Error :  
Accuracy 0.5% conforms to IEC 61869-2 & IEEE/ANSI C57.13 meets the measuring range from 5% to 120% of  $I_n$
- Phase Angle :  
50/60 Hz - 0.0 to 0.5 degrees leading from 5% to 120% of rated current (Two roop)

### Position Sensitivity

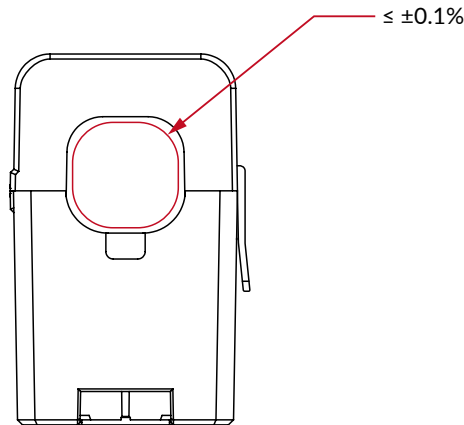

### Shock and Air Gap Test

#### ▪ Shock and Vibration Test Report

100A		100A	
Phase error(°)	Linearity Error(%)	Phase error(°)	Linearity Error(%)
0.21	- 0.15	0.21	- 0.17
0.23	- 0.16	0.22	- 0.18

#### ▪ Core Air Gap Test Report

100A		100A	
Air gap : 2microns		Air gap : 2.5microns	
Phase error(°)	Linearity Error(%)	Phase error(°)	Linearity Error(%)
0.21	- 0.15	0.21	- 0.17

## 1.2 Regulatory

- CE
- UL Listed UL2808 (XOBA) : Pollution Degree: 3 CAT IV, 600 Vac
- UL/EN61010-1(PICQ) : Pollution Degree: 3 CAT IV, 600 Vac
- RoHs Compliant

## 1.3 Environmental

- **Operating Temperature** : -40°C to 70°C (-40°F to +158°F)
- **Operating Humidity** : Non-condensing, 0 to 95% relative humidity(RH)
- **Operating Altitude** : Up to 3000 m (9842 feet)
- **Pollution Degree** : 3 (harsh environment)
- **Indoor Use** : Suitable for indoor use
- **Outdoor Use** : Suitable for outdoor use when mounted in a NEMA 3R or 4 (IP 66) rated enclosure, provided the ambient temperature will not exceed 55°C (131°F)

## 1.4 Mechanical

- **Width** : 45mm
- **Height** : 74.5mm
- **Thickness** : 33.7mm
- **Weight** : 200g
- **Core Nickel Core** : high permeability ferrite
- **Standard lead wire** : 2.44m, 18AWG

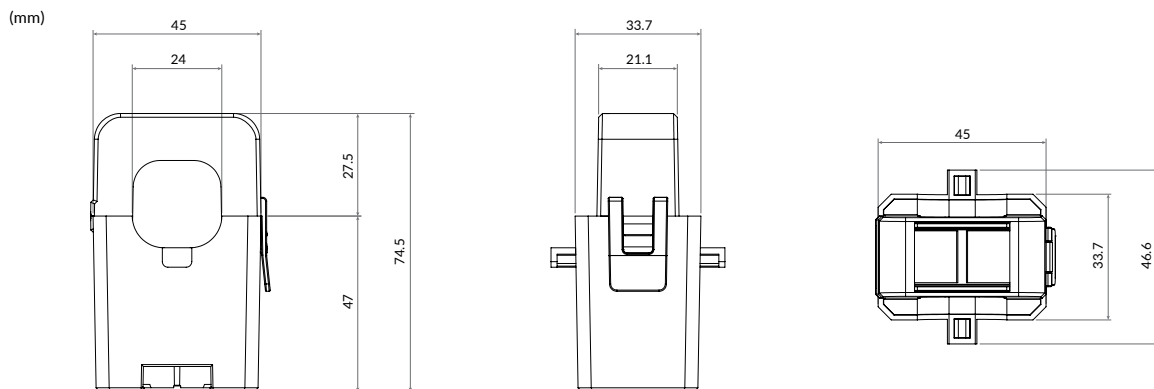

## 1.5 Labels

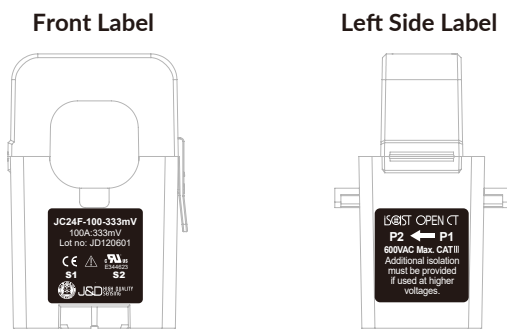

- **QR code** : <Model> ; <SerialNum> ; Scan QR code for Instruction Manual
- **Orientation** : Mount the CT referring to the right side label attached(P1->P2).

## 2. Typical Accuracy

- In the following graphs, a positive phase angle error indicates that the output of the CT leads the primary current.
- Graphs show typical performance at 25°C, 60 Hz
- Performance Graphs - The standard CT meets ANSI/IEEE C57.13 class 0.6 standard & IEC 61869-2 class 0.5 standard

### 2.1 Schematic Diagram

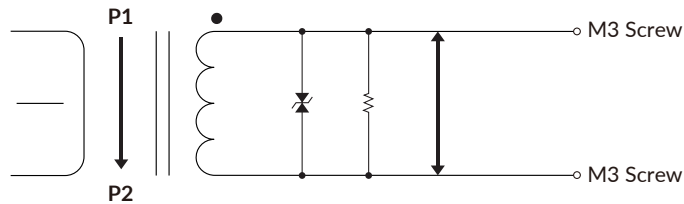

### 2.2 JC24F-005-333mV

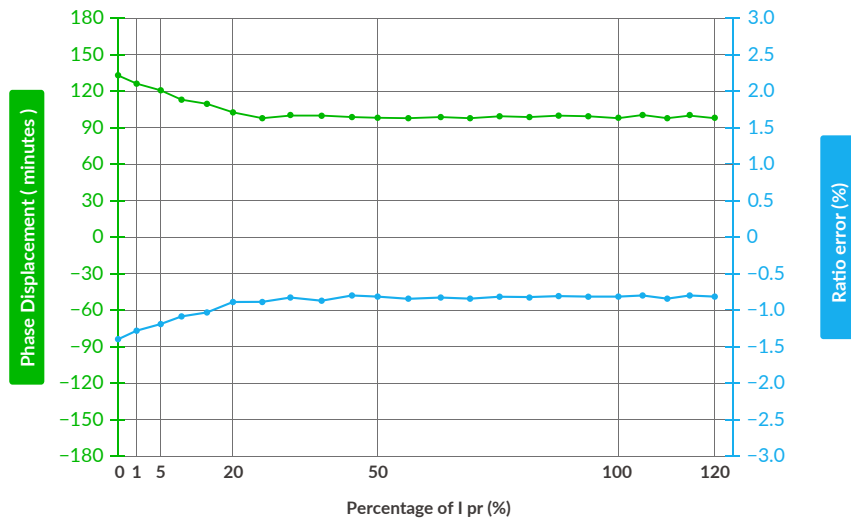

### 2.3 JC24F-010-333mV

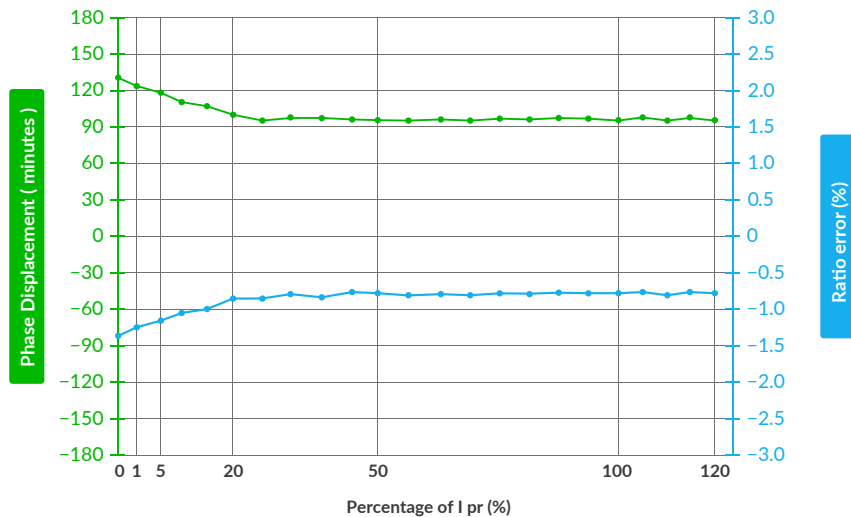

2.4 JC24F-030-333mV

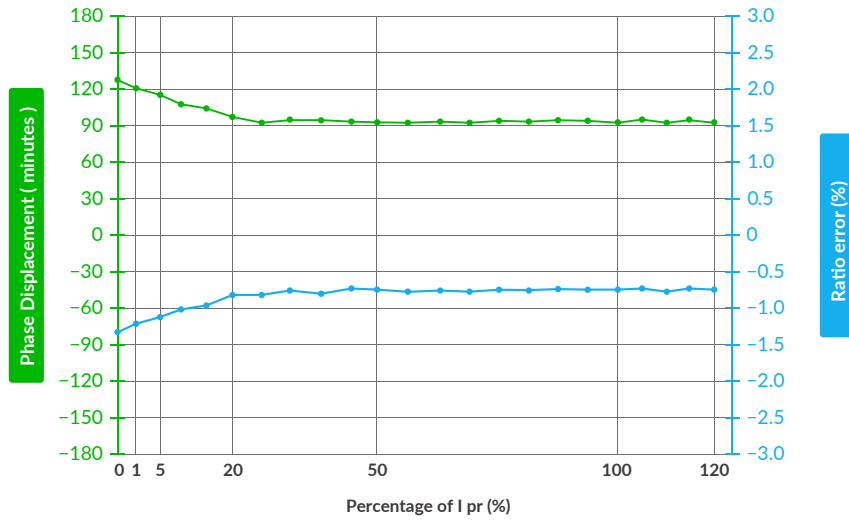

2.5 JC24F-050-333mV

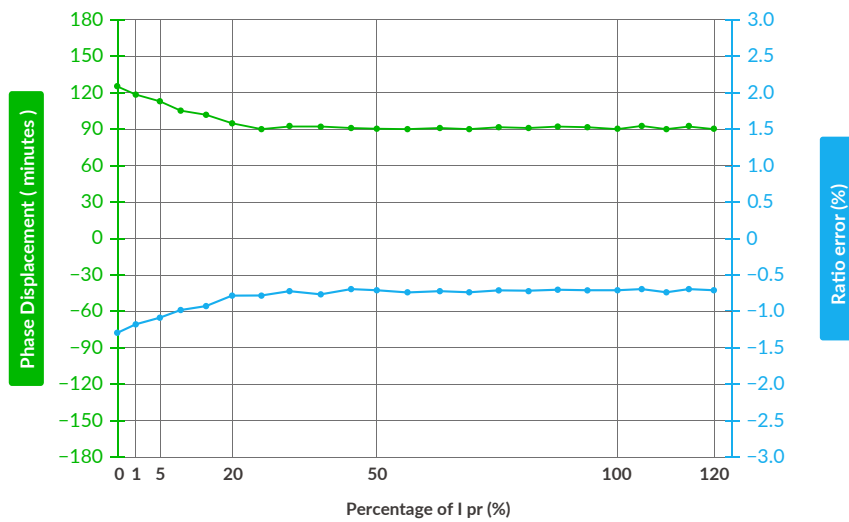

2.6 JC24F-070-333mV

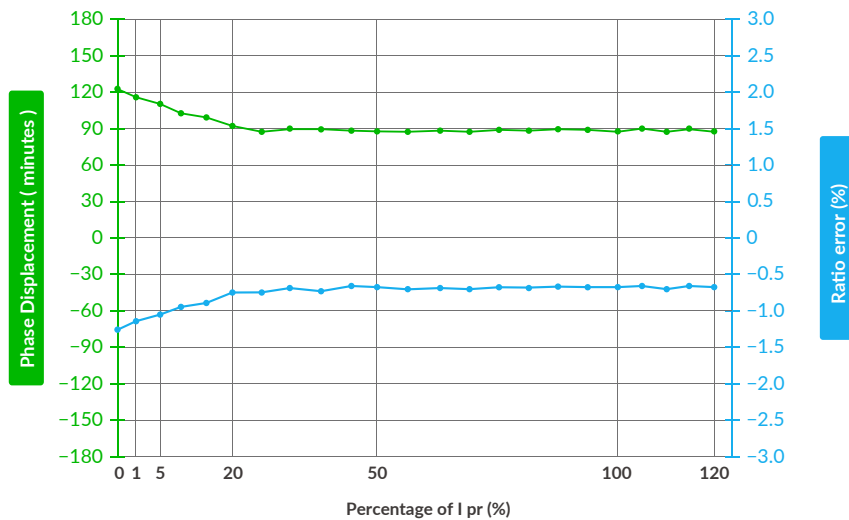

2.7 JC24F-030-333mV

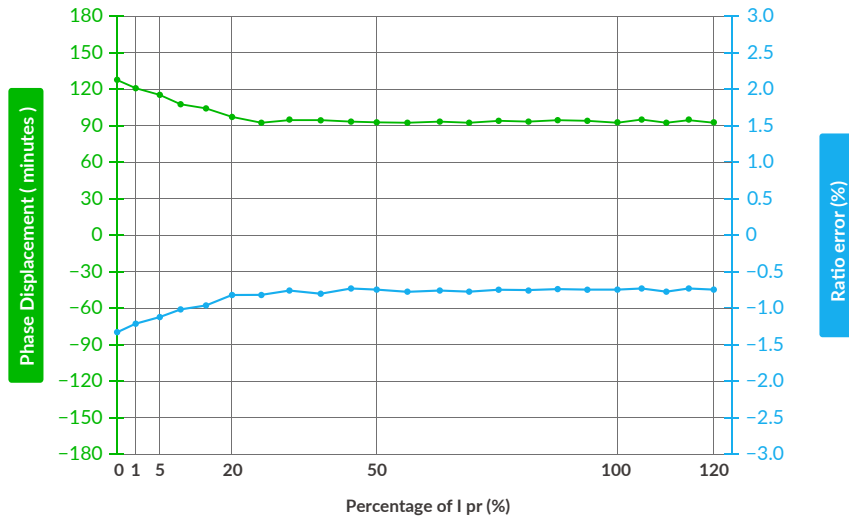

2.8 JC24F-050-333mV

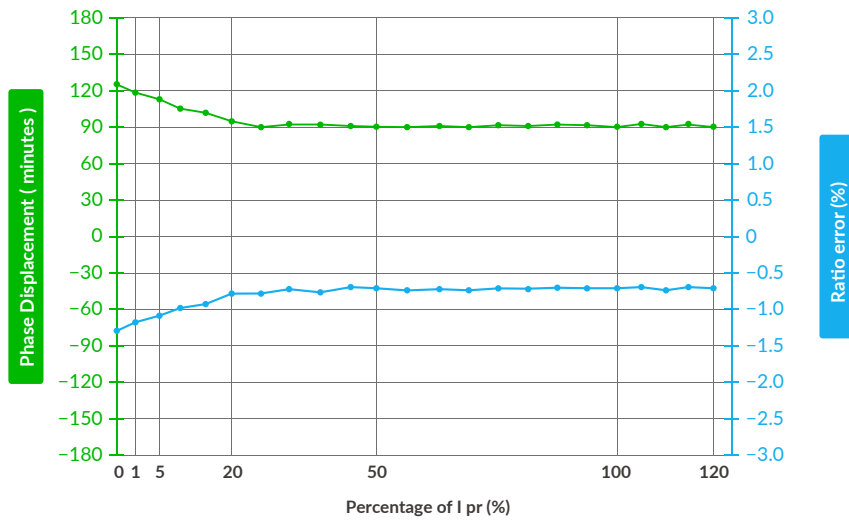

2.9 JC24F-070-333mV

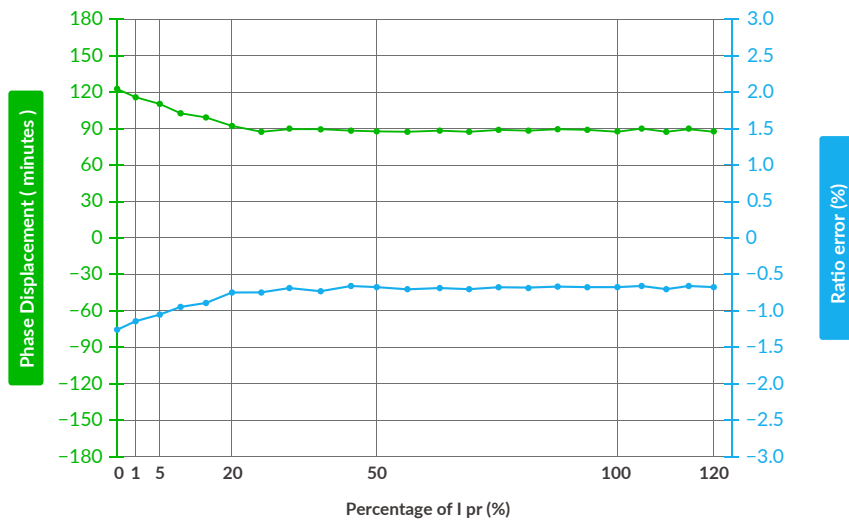

### 3. Safety Notes



Caution : Danger



**HAZARD OF ELECTRIC SHOCK, EXPLOSION, OR ARC FLASH**

- In order to guarantee safe operation of the transformer, please read and understand the instructions thoroughly. For your reference, see NFPA 70E in the USA, or applicable local codes.
- This equipment must only be installed and put into operation by qualified electrical personnel or appropriately trained individual.
- Before servicing the CTs, turn off all sources of power and use a properly rated voltage sensing device to check if the power is off.
- Current transformer secondary must be shorted or connected to a burden all times.
- The transformer (split core type) must not be operated when it is not fully closed or the installation is not completed.
- Rearrange all covers and protective devices before powering the equipment.



Notice

- This product is not intentionally made for safety applications.
- Make sure not to install this transformer in hazardous or classified areas.
- The installer is responsible for conformance to all applicable codes.
- Ignoring the warnings can lead to serious injury and/or cause damages.
- A qualified person is the one who is skilled and has knowledge about the construction and operation of this electrical equipment, and has received safety training to recognize and avoid the hazards involved. (NEC2011 Article 100)
- If this product is used in a way not specified by the manufacturer, the protection offered by the product may be impaired. No responsibility is taken by J&D Electronics for any consequences arising by not following this material properly.