

**J&D**

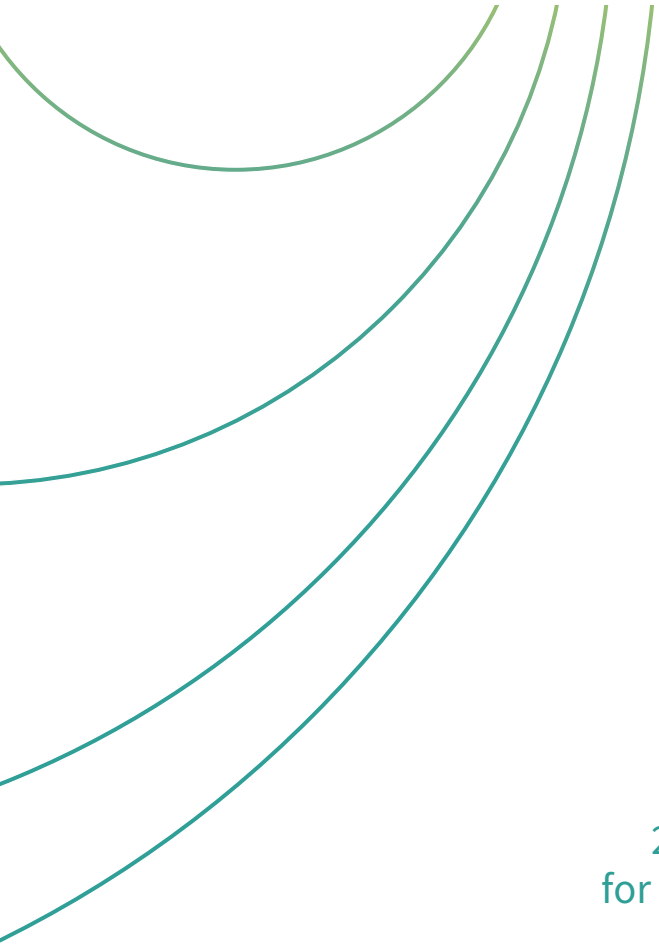

2023 new JPS series of current transformers  
for Revenue-grade and current quality analysis

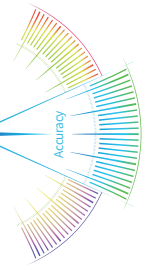



## J&D announces JPS series current transformers rated to UL2808.

### From Pioneers to Innovators: The Story of J&D

When J&D was founded more than 20 years ago, it was not possible to imagine how far our industry would expand. J&D is one of the pioneering companies that supported customers in implementing smart metering by using voltage and current sensors. Now, we have a close relationship with the most innovative power quality and smart metering companies in the world due to our efforts over the years.

As of today, we have helped to empower the market so that customers can have control over breakthrough products, and the rapid growth of human energy use could be ensured until the future. We are "innovation" at the DNA level. Our customers are also innovators and have contributed to making the new boundaries of branding and industry today. These changes always inspire us.

We are recognized as leaders in the smart metering market due to our constant efforts and dedication to improving traditional energy efficiency solutions for the development of our customers and industries. We strive to delight our customers by providing better value and innovative energy efficiency solutions that enhance their operations and industry.

### Take Your Energy Monitoring to the Next Level with the JPS Series

Our spirit is filled with a passion for maintaining innovative power quality, revenue grade metering, and energy efficiency measures at all times.

The JPS series of split-core current transformers boasts remarkable linearity and low-end accuracy, a result of its specific design for use with solar inverters, variable speed motor drives, and other applications with significant current variations. Available in both power quality and revenue grade accuracy models, the revenue grade models of JPS series come with a serialized certificate of calibration.

### The JPS Series: A New Design for Compliance with UL 2808

The JPS series of split-core current transformers (CTs) boasts high-accuracy technology that is UL certified to meet the 2017 NEC code requirement. This code demands that CTs installed in the field must be UL 2808 Listed. Before the advent of the JPS series, most CTs used with electric submeters were classified as "Recognized" rather than "Listed" components. In 2012, the UL 2808 CT safety standard was introduced under category code XOBA, covering open-type, "split-core" current transformers. The National Fire Protection Association (NFPA) Technical Committee, responsible for maintaining the National Electrical Safety Code (NESC), passed an amendment that requires UL Listed CTs, not UL Recognized CTs. This amendment is for CTs used in measuring current on service entrance or branch circuit conductors within panel boards, switchboards, industrial control equipment, and energy-monitoring/management equipment that must conform to the UL 2808 (XOBA) standard.

**Join the innovative journey together with JPS series.**

Our Story	2
Our Technologies	4
J&D announces split core current transformers rated to UL 2808 & UL/EN 61010-1	4
Split Core Current Transformer JPS Series Expanded with Network Power	5
Challenges to Implementing a Power Quality Solution in low-voltage range	6
<b>JPS Series</b>	<b>8</b>
JPS10N-XXXX-100mA SERIES	8
JPS20N-XXXX-100mA SERIES	14
JPS33N-XXXX-100mA SERIES	22
JPS52N-XXXX-100mA SERIES	28
JPS10N-XXXX-333mV SERIES	36
JPS20N-XXXX-333mV SERIES	44
JPS33N-XXXX-333mV SERIES	52
JPS52N-XXXX-333mV SERIES	58
<b>JPS Safety</b>	<b>65</b>
Safety Guide	65
<b>JPS Installation</b>	<b>66</b>
Installation Guide	66
<b>JPS Certificate</b>	<b>68</b>
Certificate of Calibration	68



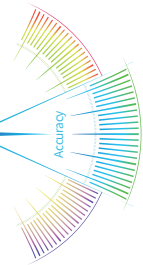

# J&D announces split core current transformers rated to UL 2808 & UL/EN 61010-1

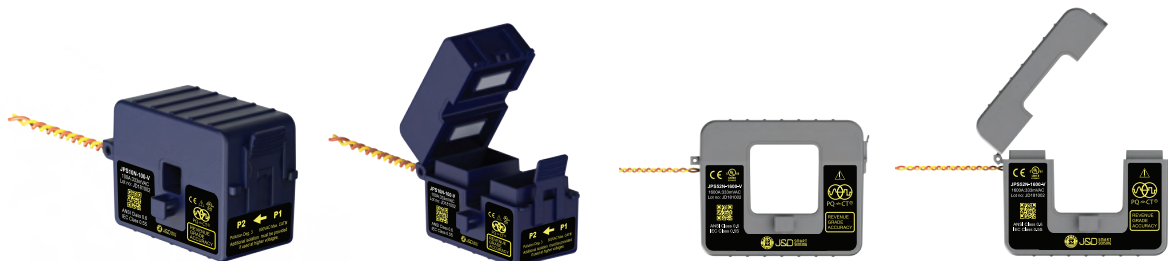

The JPS series of high-accuracy split-core current transformers are certified by UL Listed to meet the new 2017 NEC code requirement that CTs installed in the field must be UL 2808 Listed.

The next-generation CT, the JPS series, guarantees trouble-free operation even in the harmonic band of up to 9 kHz. However, in order to avoid measurement errors as much as possible in the presence of harmonic oscillations, the measurement system is limited to 1 kHz of the frequency spectrum being monitored.

Some of the key standards created by industry are IEC 61000-4-30 Class A and Class S, IEC61000-4-7 harmonic measurements, and IEC61000-4-15 for flicker.

In electrical networks, voltage sags, swells, flickers, variation in nominal ratings, and distortion due to harmonics all contain the key information regarding the electrical health of the network.

Therefore, the accuracy of current measurement is highly related to power quality, and the current measurement accuracy is the key to providing reliable and repeatable results.

At this time, the demand of wide frequency range, revenue-grade current transformers to revenue-grade metering requiring high accuracy measurement is growing because it is important to enhance network power quality for the reliable results.

The innovative design of JPS-CT split core current transformer technology provides excellent linearity and low-end accuracy.

JPS-CTs are available in both current quality analysis and revenue grade accuracy models.

Revenue grade models ship with a serialized certificate of calibration.

JPS offers full feature power quality solutions including the Revenue-Grade CTs.

**The JPS-CT revenue grade, split-core current transformer**

PERFECT SPLIT-CORE TECHNOLOGY

- 1
- 2
- 3
- 4

**PROTECTION INSIDE**

IEC 61869-2, Class 0.2S & 0.5S

IEEE/ANSI C57.13, Class 0.3 & 0.6

**SHOCK and VIBRATION TEST REPORT(JPS33)**

No	Before Test		→	Before Test	
	400A(1Ω)			400A(1Ω)	
	Phase error(°)	Linearity Error(%)		Phase error(°)	Linearity Error(%)
1	0.21	-0.15		0.21	-0.17
2	0.23	-0.16		0.23	-0.18

**CORE AIR GAP TEST REPORT(JPS33)**

No	Before Test		→	Before Test	
	400A(1Ω)			400A(1Ω)	
	Phase error(°)	Linearity Error(%)		Phase error(°)	Linearity Error(%)
	Air gap : 2microns			Air gap : 2.5microns	
1	0.21	-0.15		0.21	-0.17

## Split Core Current Transformer JPS Series Expanded with Network Power

The rise in non-linear devices and alternative energy sources is expected to cause a continuous increase in harmonic loads in global networks, making a return to linear loads unlikely. To address this issue, J&D offers the JPS series of split core current transformers, which provide high-precision transmission up to 9kHz and are thermally designed to withstand harmonic-loaded networks. These transformers are crucial for accurate and reliable current measurements, extending the lifespan of equipment, and addressing power quality issues that can lead to distortion and potentially overheat transformers. The JPS series is an excellent choice for revenue class metering, as it can identify and mitigate power quality issues, including harmonic distortion, and ensure precise and reliable power measurement.

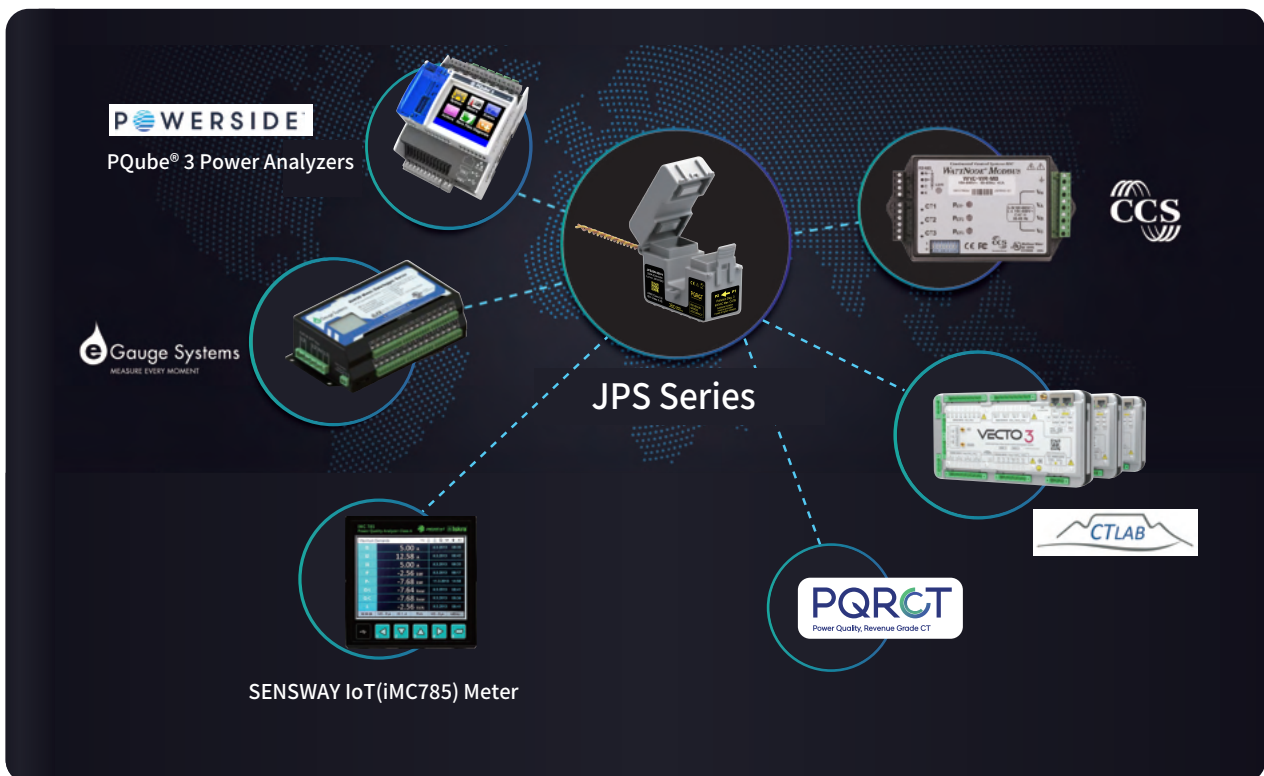

### Partner mission

J&D's partner companies are leading companies for power quality and energy meters.

Secondary Output 333mV CT of JPC Series for WattNode® Wide-Range Meter and eGauge Core or eGauge Pro meter

#### \*\*Revenue Grade Accuracy

- Meets ANSI C12.1-2014 & ANSI C12.20-2015
- Class 0.5S when used with Class 0.2S CTs

Secondary Output 333mV CT of JPC Series for PQube 3 power analyzers

PQube3 is the energy meter certified to the world's most accurate standards: fully certified to: IEC 62053-22 Class 0.2Sand ANSI C12.20 Class 0.2. Brief features include: Class A Power Quality, Energy Revenue meter, Cloud and Email data comms.

Secondary Output 100mA CT of JPC Series for VECTO 3 The grid-monitoring edge-computer and iMC 784 Advanced Power Quality Analyzer

This IEC 61000-4-30 Class A Edition 3 certified PQ meter is intended for permanent Power Quality monitoring and detailed event analysis on all voltage and current levels

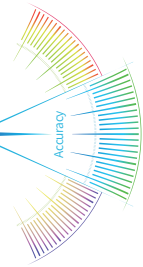

# Challenges to Implementing a Power Quality Solution in low-voltage range

## International standards compliant JPS series current transformers

### IEC 61000-4-7 Class-A

The nominal supply voltage ( $U_{NOM}$ ), nominal current ( $I_{NOM}$ ), and frequency will vary depending on the location and application of the power quality device. Independent of the nominal value the instrument measures, the IEC 61000-4-7 standard requires power quality measurement instruments to reach the accuracies given in the table. Therefore, the transducer must be selected so that the instrument meets the accuracy requirements.

Class	Measurement	Conditions	Maximum Error
A	Voltage	$U_M \geq 1\% U_{NOM}$ $U_M < 1\% U_{NOM}$	$\pm 5\% U_M$ $\pm 0.05\% U_{NOM}$
	Current	$I_M \geq 3\% I_{NOM}$ $I_M < 3\% I_{NOM}$	$\pm 5\% I_M$ $\pm 0.15\% I_{NOM}$
	Power	$P_M \geq 150 W$ $P_M < 150 W$	$\pm 5\% P_M$ $\pm 1.5\% W$
S	Voltage	$U_M \geq 3\% U_{NOM}$ $U_M < 3\% U_{NOM}$	$\pm 5\% U_M$ $\pm 0.15\% U_{NOM}$
	Voltage	$I_M \geq 10\% I_{NOM}$ $I_M < 10\% I_{NOM}$	$\pm 5\% I_M$ $\pm 0.15\% I_{NOM}$

\*\* Accuracy Requirements for Current, Voltage, and Power Measurements Specified by IEC 61000-4-7 Standard

$I_{NOM}$ : Nominal current range of the measurement instrument

$U_{NOM}$ : Nominal voltage range of the measurement instrument

$U_M$ ,  $I_M$ , and  $P_M$ : Measured values

The IEC61000-4-7 standard recommends designing the input circuitry following these nominal voltages ( $U_{NOM}$ ) and nominal currents ( $I_{NOM}$ ):

- For 50 Hz systems: 66 V, 115 V, 230 V, 400 V, 690 V
- For 60 Hz systems: 69 V, 120 V, 240 V, 277 V, 347 V, 480 V, 600 V
- 0.1 A, 0.2 A, 0.5 A, 1 A, 2 A, 5 A, 10 A, 20 A, 50 A, 100 A

Additionally, transducers selected for voltage and current measurement must maintain their characteristics and accuracy unchanged when  $1.2 \times U_{NOM}$  and  $I_{NOM}$  are continuously applied. A signal of 4 times the nominal voltage or 1 kV rms, whichever is less, must not be damaged when applied to the instrument for 1 second. Likewise, a  $10 \times I_{NOM}$  current for 1 second will not cause any damage.

### VDE-AR-N 4100

VDE-AR-N 4100 is a standard regulation for distribution network operators.

The latest draft of VDE-AR-N 4100 addresses this issue.

Subclause 5.4.4.3 of this regulation refers to harmonic currents up to 9 kHz.

Monitoring is required and includes power plants as well as receiving facilities and storage systems.

Customers should take steps to reduce harmonic currents, especially by building a filter circuit.

Therefore, current measurements up to 9 kHz will continue in low-voltage networks in the future.

Looking at the bigger picture of distributed energy power plants and the rise of non-linear consumers, this turns out to be a very smart move.

Power companies and their customers need measurement equipment that can accurately record harmonic currents up to 9 kHz.

## The changes in the structure of generation and consumption

Increase in renewable energy generation and non-linear loads is having a major impact on the reliability and quality of power grid, which has led to the need for new measuring requirements for inductive current transformers in the low-voltage range.

The introduction of more and more renewable energy sources with non-linear inverters has increased the level of harmonics in the grid, which can cause voltage distortions, equipment malfunctions, and even failures if not properly managed.

Harmonics can have various negative effects on the power grid and the connected equipment.

One of the most significant economic impacts is the overloading of neutral conductors, which can cause overheating and even fires.

Another effect is the generation of disturbing noise in the frequency range up to 16 kHz, which can be annoying to humans and affect sensitive equipment such as audio systems.

In renewable energy generation, inverters or frequency converters are used, which cause distortions due to the switching semiconductor elements, resulting in harmonics that can extend into the single-digit kilohertz range.

On the consumer side, the shift to non-linear loads such as LED lights and switched-mode power supplies has also contributed to the increase in harmonics and reactive power.

There are already international norms that limit harmonic currents in end devices with a power consumption greater than 75 W, but devices under 75 W are not currently covered by standards.

This has resulted in manufacturers not usually implementing filter measures or complex power factor correction. Additionally, the standards only define limit values up to 2 kHz.

In the industrial sector, more and more electrical motors with variable-frequency drive technology are being used, which can generate high levels of total harmonic distortion.

Grid operators are primarily interested in the economic effects of harmonics, including overloading of neutral conductors, overheating of transformers, false tripping of circuit breakers/miniature circuit breakers, overstressing of power-factor correction capacitors, and skin effects.

If the distortion level in the supply voltage reaches a value greater than 10%, it shortens the lifetime of devices considerably, and over-dimensioning of devices is required to maintain their expected lifetime.

Therefore, new measuring equipment is needed to accurately record harmonic currents of up to 9 kHz across the whole low-voltage network to mitigate the economic effects of harmonics.

Harmonics can also cause overheating of transformers, false tripping of circuit breakers and miniature circuit breakers, and overstressing of power-factor correction capacitors.

Additionally, harmonics can cause skin effects, which result in increased resistance and heating in conductors at high frequencies.

However, the most significant concern is that harmonics can affect the voltage quality of the power supply.

Non-linear loads can cause voltage harmonics, which can violate the required EN 50160 standard for voltage quality. This can ultimately result in a violation of the electricity supply contract.

Therefore, it is important to control harmonic currents and ensure compliance with relevant standards to maintain a stable and high-quality power supply.

Harmonic graphs of JPS33N-XXXX-100mA SERIES

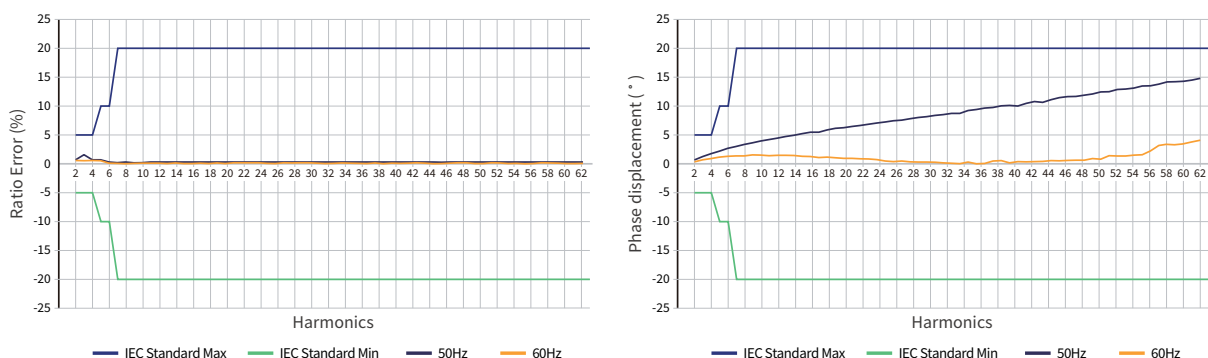

The output signal of the split core current transformer is 333mV or 100mA, and it shows stable characteristics in terms of phase difference and ratio error even with 0.2S and 0.5S accuracy according to IEC 61869-2 and the 63rd harmonic.



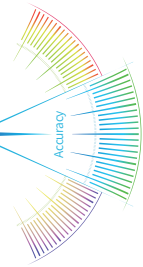

## Current Transformers

# JPS10N-XXXX-100mA SERIES

The JPS series of split core current transformers is designed for easy and efficient installation, making them ideal for use in both new construction and retrofit applications. The split core design enables quick and simple installation by allowing the CT to be easily opened and placed around the power cable. The JPS series also features enhanced durability, making them resistant to the effects of vibration and shock.

The JPS series of CTs can accurately measure the current flowing through the power line with Revenue grade accuracy. This makes them suitable for use in Power Quality measuring and Revenue Grade metering applications. The unique design of the JPS series is listed under UL 2808 and UL/EN 61010-1, allowing for field installation of the CT in manufactured subpanels and electrical cabinets while maintaining the UL rating and manufacturer warranty.

In addition, the JPS series CTs feature a secure locking mechanism that is noticed by a single click sound. This ensures that the CTs remain firmly in place and do not shift or move, providing accurate and reliable current measurement. Overall, the JPS series of split core current transformers offers a convenient and effective solution for current measurement in a variety of applications.

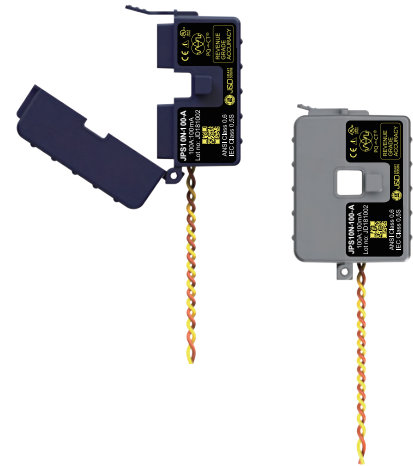

### Advantages

- IEEE/ANSI C57.13, Class 0.3/0.6 accuracy
- IEC 61869-2 Class 0.2S/0.5S accuracy
- Accessories options for installation (Terminal, plug-in, RJ12 port)

### Application

- ANSI C12.20 of class 0.2/0.5
- IEC 62053-22 of Class 0.2S/0.5S
- IEC 61000-4-30 A ED3 for Power Quality Meter

### Standards

- UL Listed UL2808 (XOBA) : Pollution Degree: 3 CAT IV, 600 Vac
- UL/EN61010-1(PICQ) : Pollution Degree: 3 CAT IV, 600 Vac

Model	Rated Amps	Output	Accuracy	Internal Burden (Ohms)
JPS10N-030-100mA	30A	100mA	0.5%	1.66Ω
JPS10N-050-100mA	50A	100mA	0.5%	4.93Ω
JPS10N-070-100mA	70A	100mA	0.5%	9.22Ω
JPS10N-100-100mA	100A	100mA	0.2/0.5%	19.73Ω

### How to Use

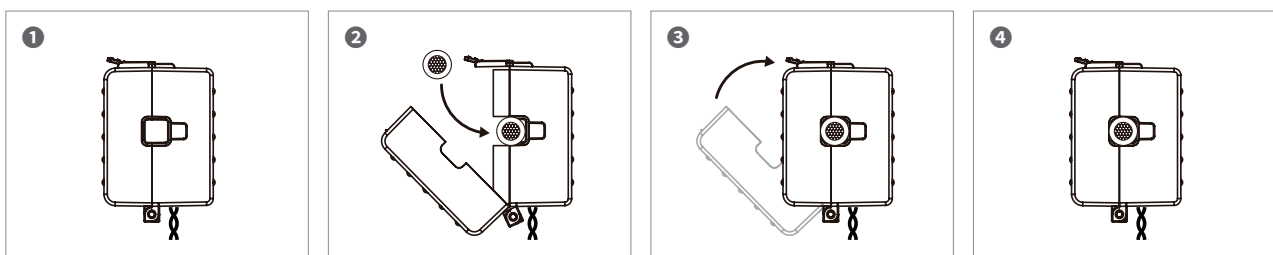

Please refer to "Split-core Current Transformer Installation Guide" for further details.



## 1. Specifications

- Accuracy : Class 0.5S
- System Voltage : 720 V (0.72 kV)
- Overload Withstand : 1.2 times rated current continuously
- Compliant with : IEC/EN 61869-2 & IEEE/ANSI C57.13
- Operating Temperature Range : -40°C to 70°C
- Relative Humidity : 0 to 90% non-condensing
- Test Voltage : 3 kV for 1 minute
- Frequency Range : 50/60 Hz
- Protection Level : 3.0V0-P
- Insulation Category : CAT III 1000 Vac, CAT IV 600 Vac
- Output Lead Wires :  
 Style : Two conductor, brown and yellow twisted pair (equivalent to about one #8 AWG 0.213" dia.), MTW, UL 1015  
 Standard length : 8 ft (2.44m), Gauge : #18 AWG, Voltage : 600Vac

### 1.1 Accuracy

- Ratio Error :  
 Accuracy 0.5% conforms to IEC 61869-2 & IEEE/ANSI C57.13 meets the measuring range from 1% to 120% of  $I_n$
- Phase Angle :  
 50/60 Hz – 0.0 to 2.0 degrees leading from 1% to 120% of rated current

### Position Sensitivity

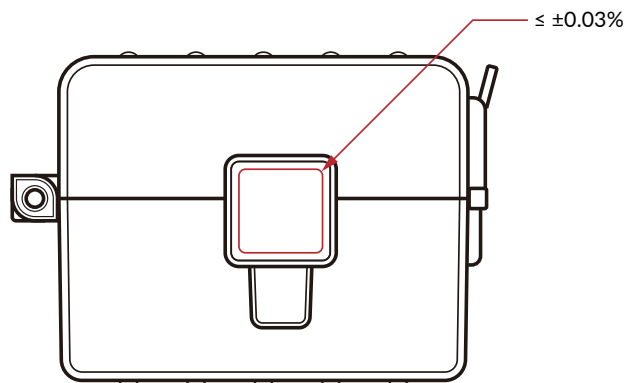

### Shock and Air Gap Test

- Shock and Vibration Test Report(JPS10)

100A		→	100A	
Phase error(°)	Linearity Error(%)		Phase error(°)	Linearity Error(%)
0.21	- 0.15		0.21	- 0.17
0.23	- 0.16		0.22	- 0.18

- Core Air Gap Test Report(JPS10)

100A		→	100A	
Air gap : 2microns			Air gap : 2.5microns	
Phase error(°)	Linearity Error(%)		Phase error(°)	Linearity Error(%)
0.21	- 0.15		0.21	- 0.17

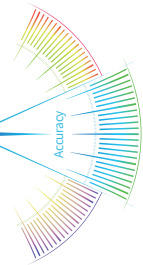

## Harmonic Graphs

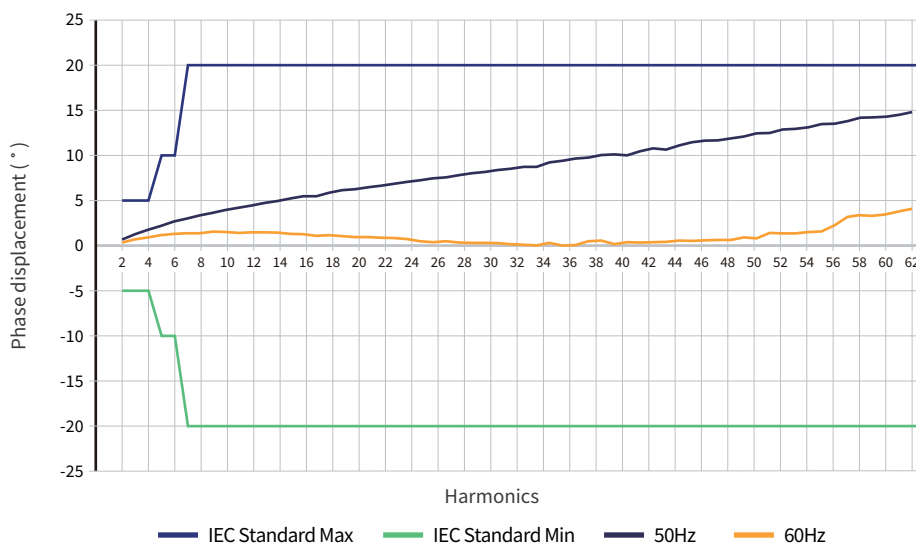
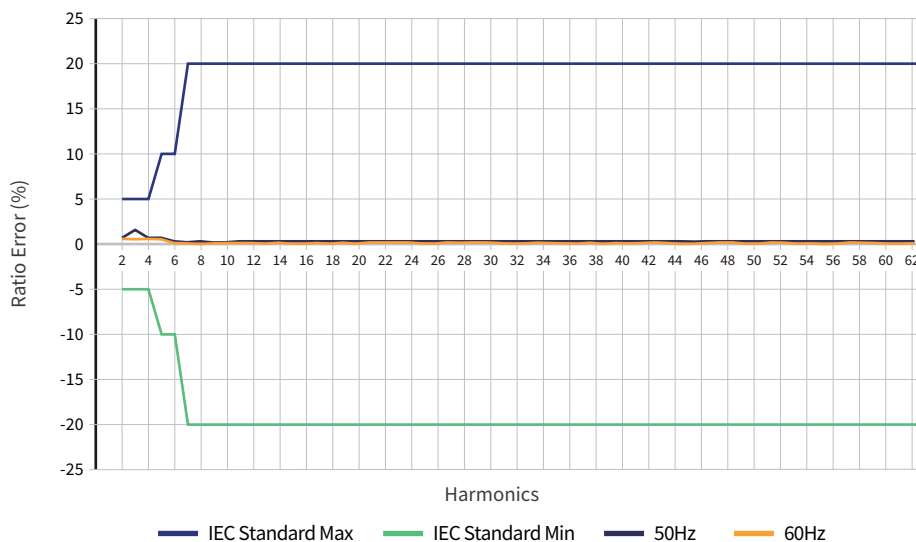

### 1.2 Regulatory

- CE
- UL Listed UL2808 (XOBA) : Pollution Degree: 3 CAT IV, 600 Vac
- UL/EN61010-1(PICQ) : Pollution Degree: 3 CAT IV, 600 Vac
- RoHs Compliant

### 1.3 Environmental

- Operating Temperature : -40°C to 70°C (-40°F to +158°F)
- Operating Humidity : Non-condensing, 0 to 95% relative humidity(RH)
- Operating Altitude : Up to 3000 m (9842 feet)
- Pollution Degree : 3 (harsh environment)
- Indoor Use : Suitable for indoor use
- Outdoor Use : Suitable for outdoor use when mounted in a NEMA 3R or 4 (IP 66) rated enclosure, provided the ambient temperature will not exceed 55°C (131°F)

### 1.4 Mechanical

- Width : 61mm
- Height : 48mm
- Thickness : 35mm
- Opening : 10mm
- Weight : 230g
- Core Nickel Core : high permeability ferrite
- Standard lead wire : 2.44m, 18AWG

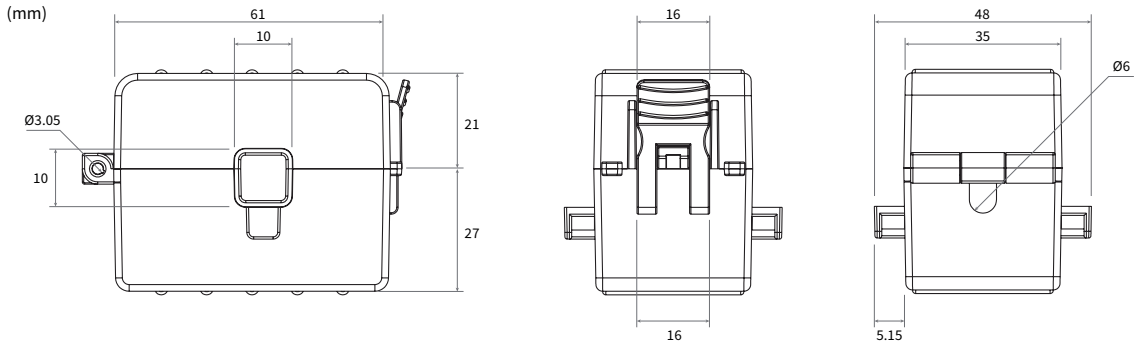

### 1.5 Labels

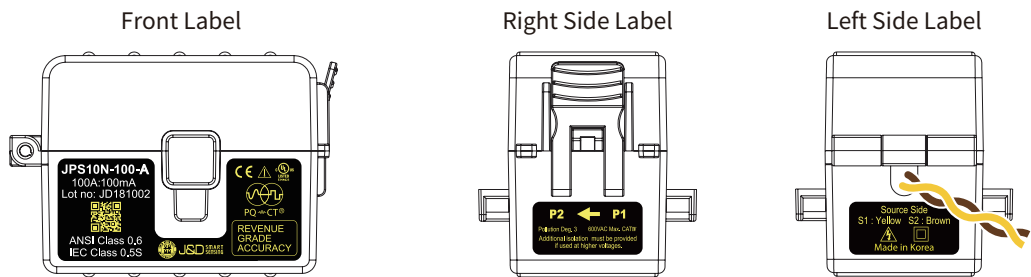

- QR code : <Model> ; <SerialNum> ; Scan QR code for Instruction Manual
- Orientation : Mount the CT referring to the right side label attached(P1->P2).

## 2. Typical Accuracy

- In the following graphs, a positive phase angle error indicates that the output of the CT leads the primary current.
- Graphs show typical performance at 25°C, 60 Hz
- Performance Graphs - The standard CT meets ANSI/IEEE C57.13 class 0.6 standard & IEC 61869-2 standard class 0.5

### 2.1 Schematic Diagram

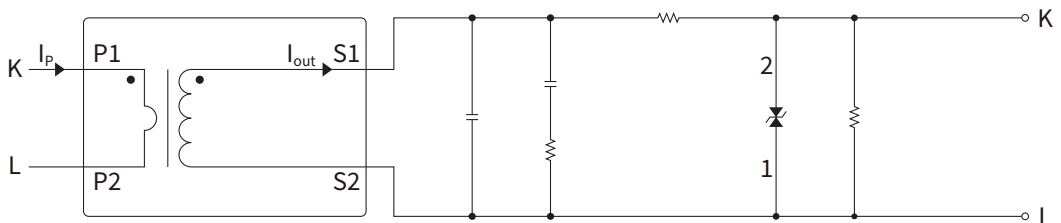

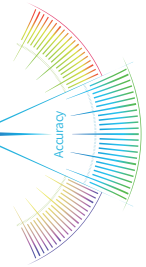

## 2.2 JPS10N-030-100mA

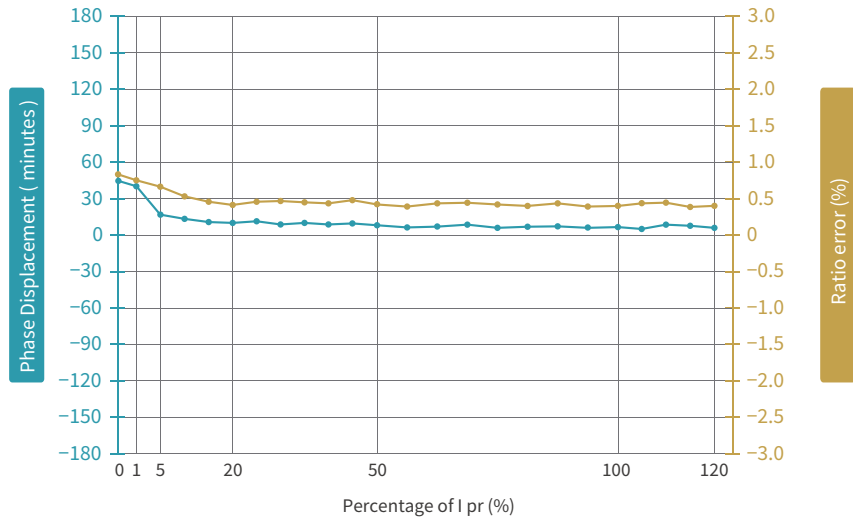

## 2.3 JPS10N-050-100mA

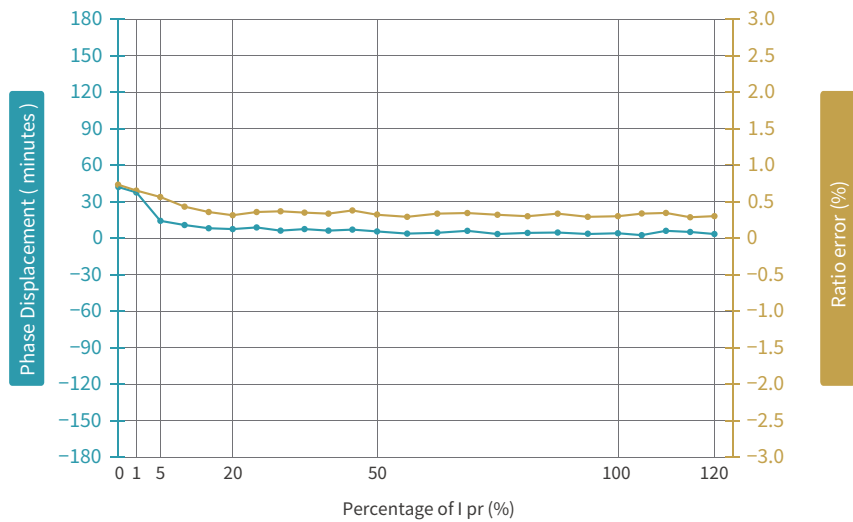

## 2.4 JPS10N-070-100mA

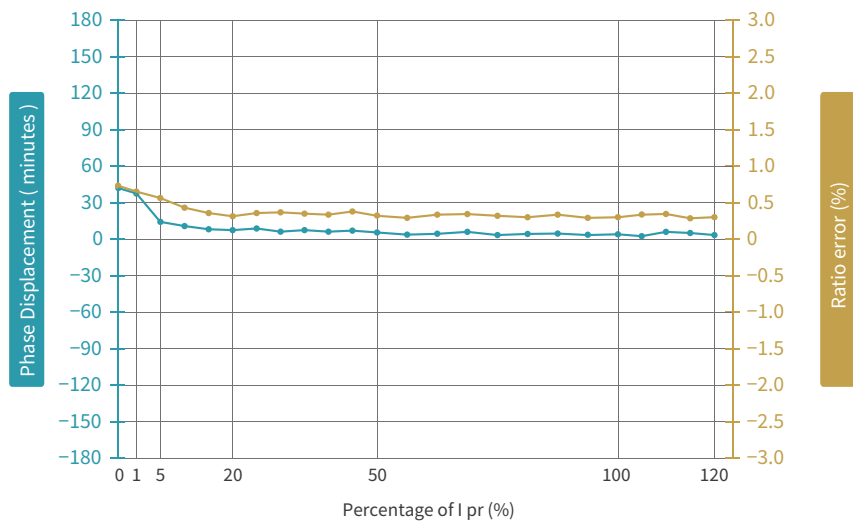

### 2.5 JPS10N-100-100mA

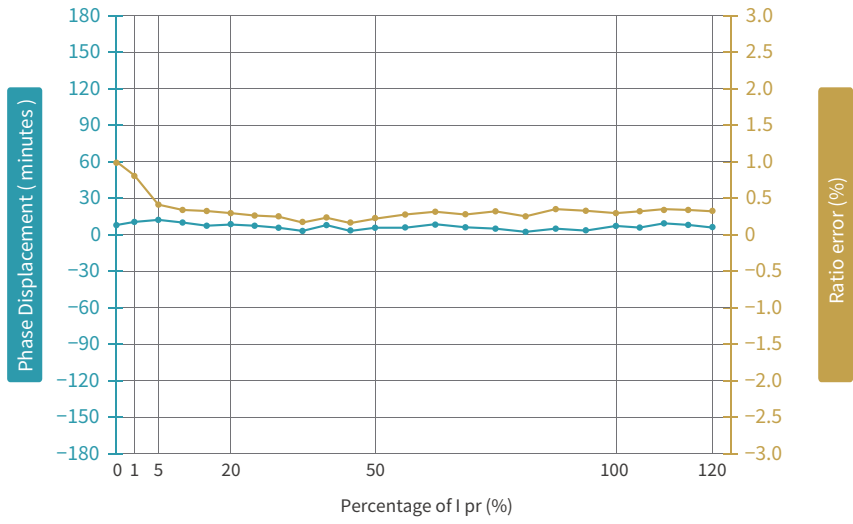

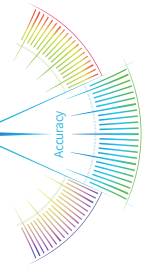

## Current Transformers JPS20N-XXXX-100mA SERIES

The JPS series of split core current transformers is designed for easy and efficient installation, making them ideal for use in both new construction and retrofit applications. The split core design enables quick and simple installation by allowing the CT to be easily opened and placed around the power cable. The JPS series also features enhanced durability, making them resistant to the effects of vibration and shock.

The JPS series of CTs can accurately measure the current flowing through the power line with Revenue grade accuracy. This makes them suitable for use in Power Quality measuring and Revenue Grade metering applications. The unique design of the JPS series is listed under UL 2808 and UL/EN 61010-1, allowing for field installation of the CT in manufactured subpanels and electrical cabinets while maintaining the UL rating and manufacturer warranty.

In addition, the JPS series CTs feature a secure locking mechanism that is noticed by a single click sound. This ensures that the CTs remain firmly in place and do not shift or move, providing accurate and reliable current measurement. Overall, the JPS series of split core current transformers offers a convenient and effective solution for current measurement in a variety of applications.

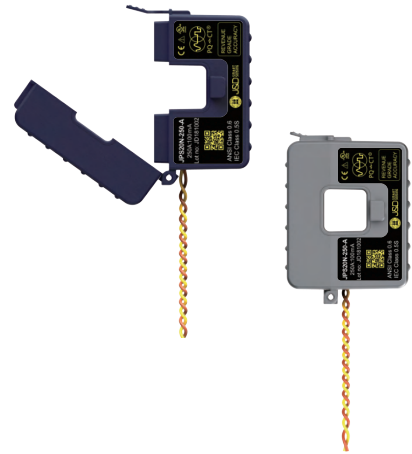

### Advantages

- IEEE/ANSI C57.13, Class 0.3/0.6 accuracy
- IEC 61869-2 Class 0.2S/0.5S accuracy
- Accessories options for installation (Terminal, plug-in, RJ12 port)

### Application

- ANSI C12.20 of class 0.2/0.5
- IEC 62053-22 of class 0.2S/0.5S
- IEC 61000-4-30 A ED3 for Power Quality Meter

### Standards

- UL Listed UL2808 (XOBA) : Pollution Degree: 3 CAT IV, 600 Vac
- UL/EN61010-1(PICQ) : Pollution Degree: 3 CAT IV, 600 Vac

Model	Rated Amps	Output	Accuracy	Internal Burden (Ohms)
JPS20N-030-100mA	30 A	100mA	0.5%	1.13 Ω
JPS20N-050-100mA	50 A	100mA	0.5%	2.70 Ω
JPS20N-070-100mA	70 A	100mA	0.5%	5.76 Ω
JPS20N-100-100mA	100 A	100mA	0.2/0.5%	10.99 Ω
JPS20N-125-100mA	125 A	100mA	0.2/0.5%	16.30 Ω
JPS20N-150-100mA	150 A	100mA	0.2/0.5%	22.47 Ω
JPS20N-200-100mA	200 A	100mA	0.2/0.5%	49.87 Ω
JPS20N-250-100mA	250 A	100mA	0.2/0.5%	68.04 Ω

### How to Use

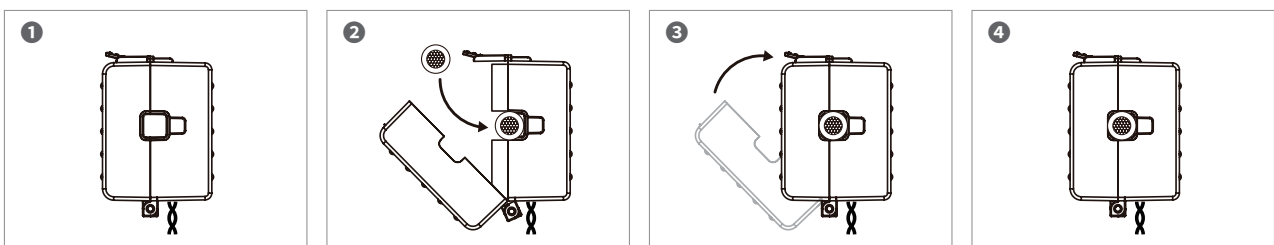

Please refer to "Split-core Current Transformer Installation Guide" for further details.

## 1. Specifications

- Accuracy : Class 0.5S
- System Voltage : 720 V (0.72 kV)
- Overload Withstand : 1.2 times rated current continuously
- Compliant with : IEC/EN 61869-2 & IEEE/ANSI C57.13
- Operating Temperature Range : -40°C to 70°C
- Relative Humidity : 0 to 90% non-condensing
- Test Voltage : 3 kV for 1 minute
- Frequency Range : 50/60 Hz
- Protection Level : 3.0V0-P
- Insulation Category : CAT III 1000 Vac, CAT IV 600 Vac
- Output Lead Wires :  
 Style : Two conductor, brown and yellow twisted pair (equivalent to about one #8 AWG 0.213" dia.), MTW, UL 1015  
 Standard length : 8 ft (2.44m), Gauge : #18 AWG, Voltage : 600Vac

### 1.1 Accuracy

- Ratio Error :  
 Accuracy 0.5% conforms to IEC 61869-2 & IEEE/ANSI C57.13 meets the measuring range from 1% to 120% of  $I_n$
- Phase Angle :  
 50/60 Hz – 0.0 to 2.0 degrees leading from 1% to 120% of rated current

#### Position Sensitivity

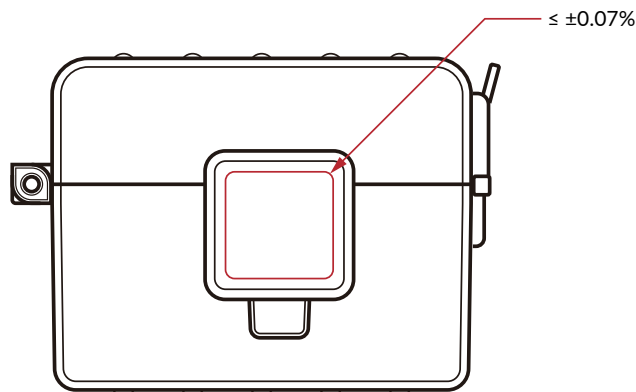

#### Shock and Air Gap Test

- Shock and Vibration Test Report(JPS20)

200A	
Phase error(°)	Linearity Error(%)
0.20	- 0.14
0.22	- 0.15



200A	
Phase error(°)	Linearity Error(%)
0.20	- 0.16
0.22	- 0.17

- Core Air Gap Test Report(JPS20)

200A	
Air gap : 2microns	
Phase error(°)	Linearity Error(%)
0.20	- 0.14



200A	
Air gap : 2.5microns	
Phase error(°)	Linearity Error(%)
0.20	- 0.16



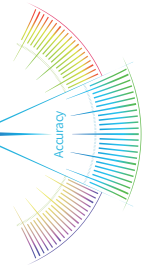

## Harmonic Graphs

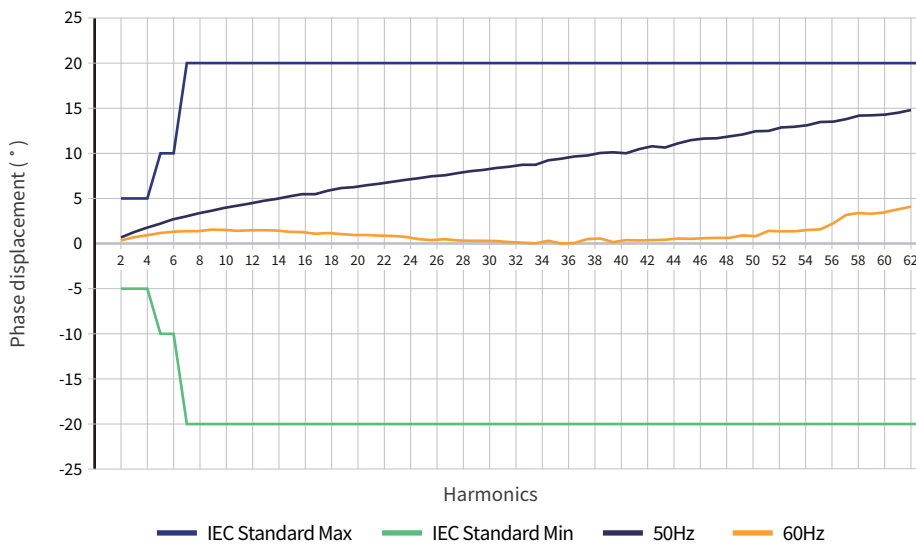
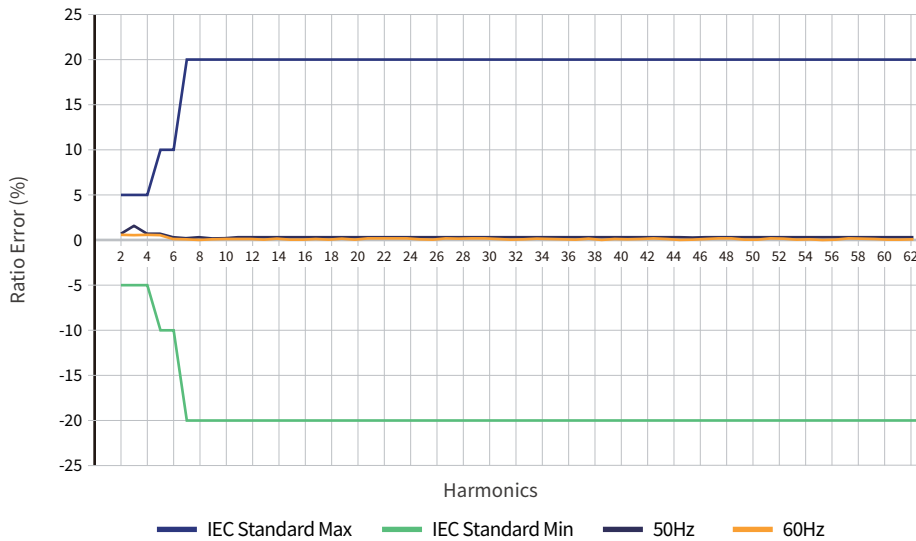

### 1.2 Regulatory

- CE
- UL Listed UL2808 (XOBA) : Pollution Degree: 3 CAT IV, 600 Vac
- UL/EN61010-1(PICQ) : Pollution Degree: 3 CAT IV, 600 Vac
- RoHs Compliant

### 1.3 Environmental

- Operating Temperature : -40°C to 70°C (-40°F to +158°F)
- Operating Humidity : Non-condensing, 0 to 95% relative humidity(RH)
- Operating Altitude : Up to 3000 m (9842 feet)
- Pollution Degree : 3 (harsh environment)
- Indoor Use : Suitable for indoor use
- Outdoor Use : Suitable for outdoor use when mounted in a NEMA 3R or 4 (IP 66) rated enclosure, provided the ambient temperature will not exceed 55°C (131°F)

### 1.4 Mechanical

- Width : 71.5mm
- Height : 58mm
- Thickness : 35mm
- Opening : 20mm
- Weight : 360g
- Core Nickel Core : high permeability ferrite
- Standard lead wire : 2.44m, 18AWG

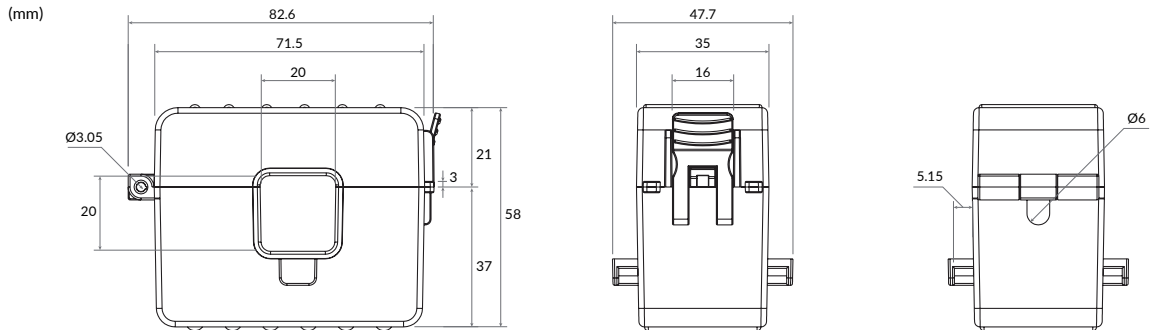

### 1.5 Labels

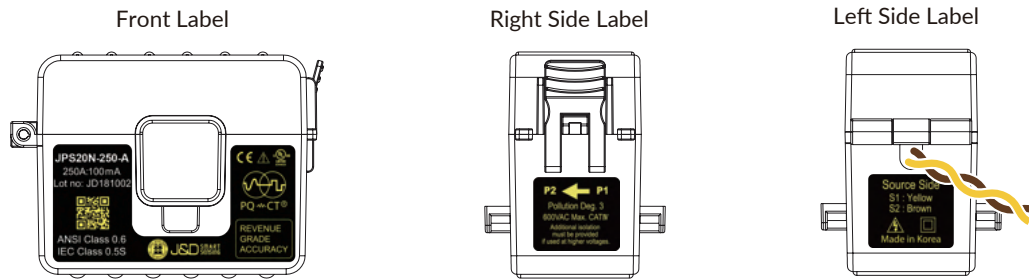

- QR code : <Model> ; <SerialNum> ; Scan QR code for Instruction Manual
- Orientation : Mount the CT referring to the right side label attached(P1->P2).

## 2. Typical Accuracy

- In the following graphs, a positive phase angle error indicates that the output of the CT leads the primary current.
- Graphs show typical performance at 25°C, 60 Hz
- Performance Graphs - The standard CT meets ANSI/IEEE C57.13 class 0.6 standard & IEC 61869-2 standard class 0.5

### 2.1 Schematic Diagram

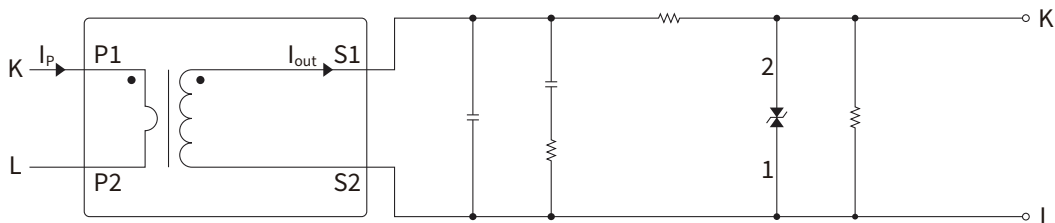

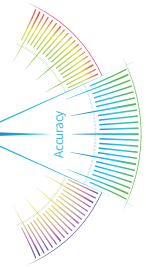

## 2.2 JPS20N-030-100mA

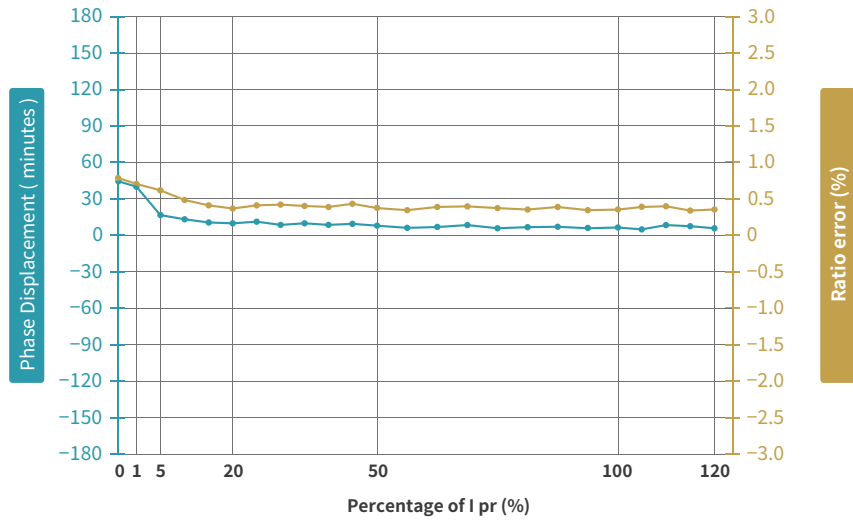

## 2.3 JPS20N-050-100mA

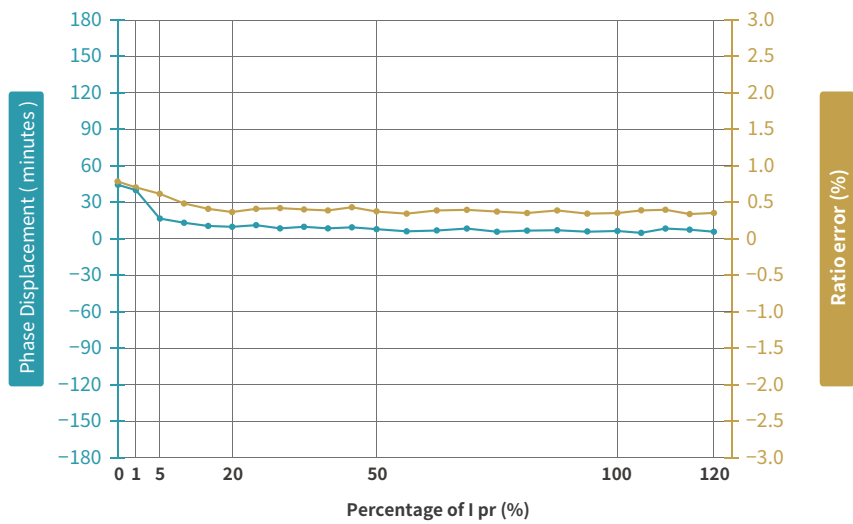

## 2.4 JPS20N-070-100mA

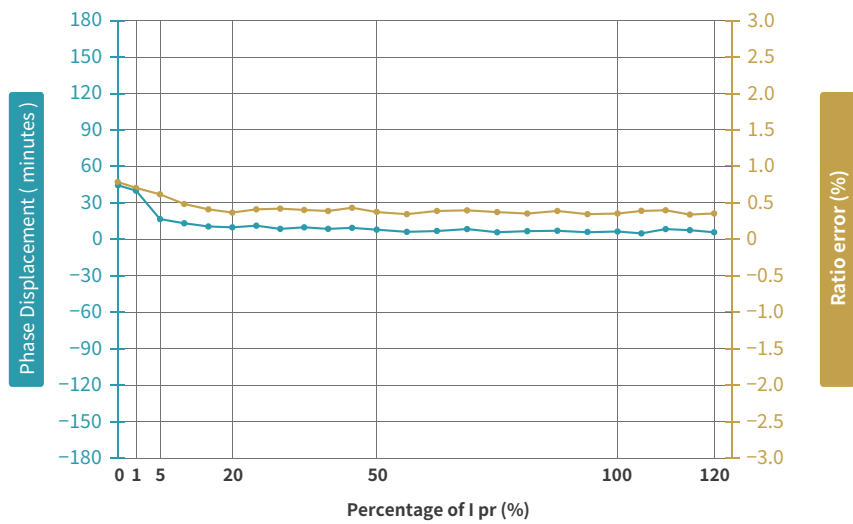

2.5 JPS20N-100-100mA

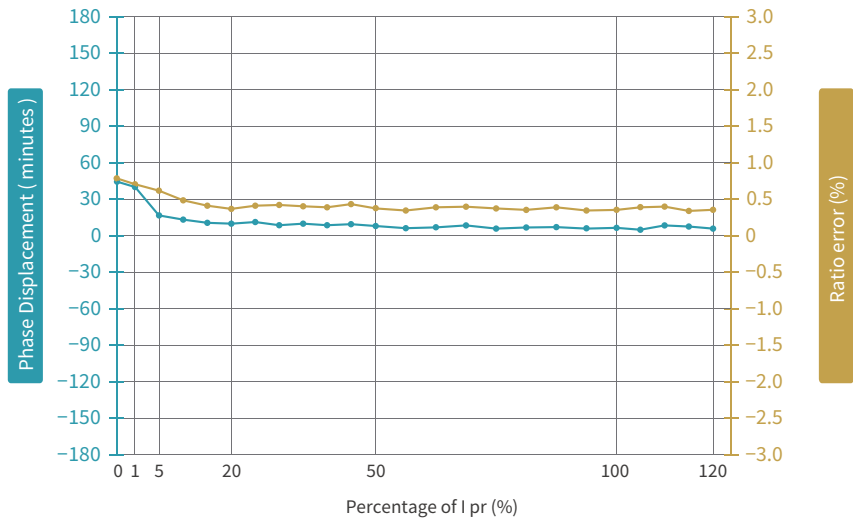

2.6 JPS20N-125-100mA

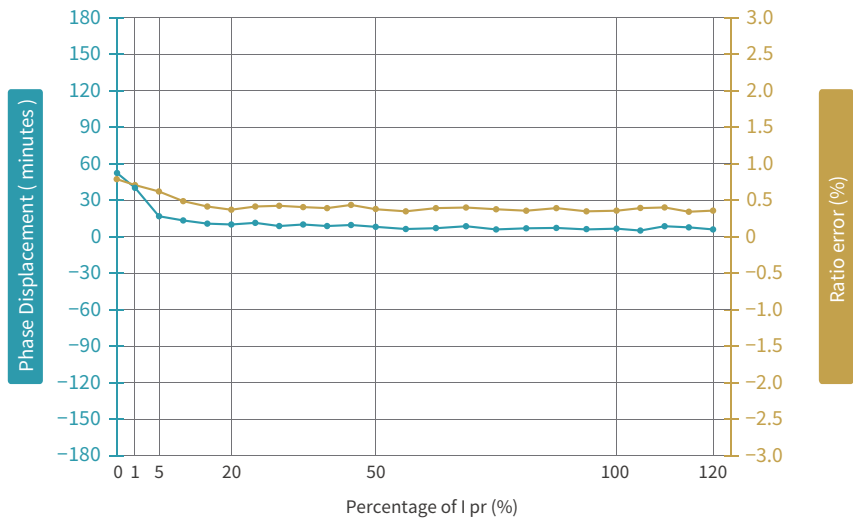

2.7 JPS20N-150-100mA

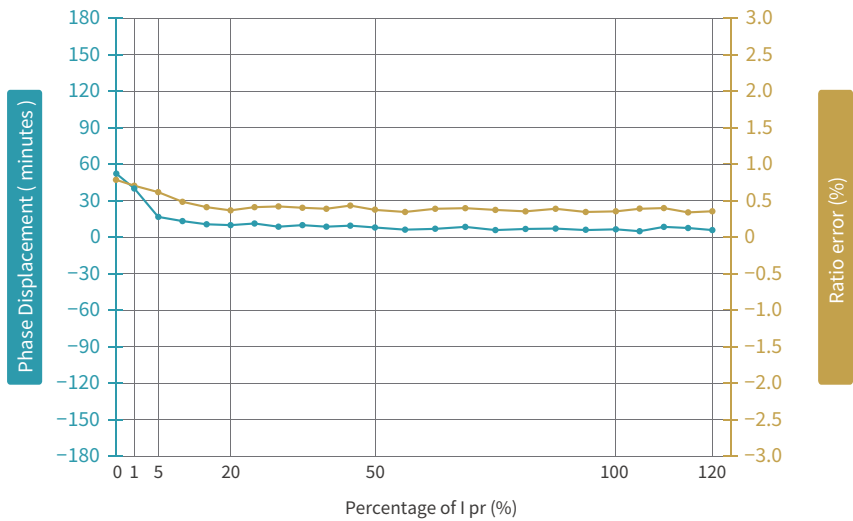

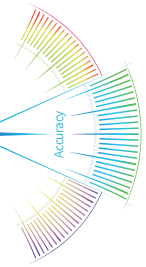

### 2.8 JPS20N-200-100mA

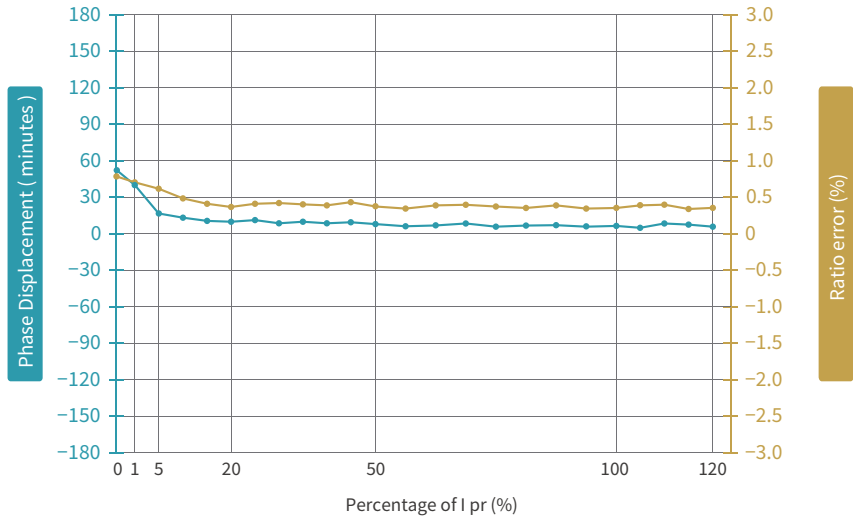

### 2.9 JPS20N-250-100mA

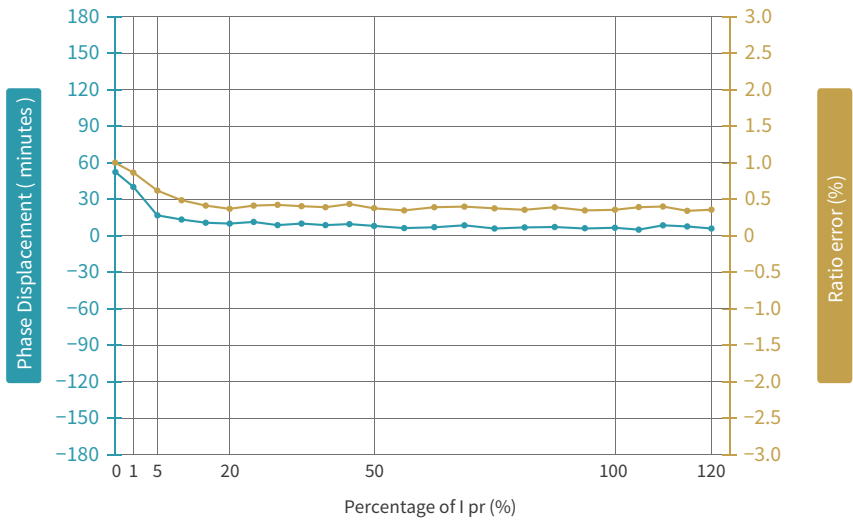



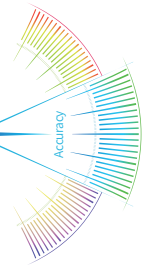

## Current Transformers JPS33N-XXXX-100mA SERIES

The JPS series of split core current transformers is designed for easy and efficient installation, making them ideal for use in both new construction and retrofit applications. The split core design enables quick and simple installation by allowing the CT to be easily opened and placed around the power cable. The JPS series also features enhanced durability, making them resistant to the effects of vibration and shock.

The JPS series of CTs can accurately measure the current flowing through the power line with Revenue grade accuracy. This makes them suitable for use in Power Quality measuring and Revenue Grade metering applications. The unique design of the JPS series is listed under UL 2808 and UL/EN 61010-1, allowing for field installation of the CT in manufactured subpanels and electrical cabinets while maintaining the UL rating and manufacturer warranty.

In addition, the JPS series CTs feature a secure locking mechanism that is noticed by a single click sound. This ensures that the CTs remain firmly in place and do not shift or move, providing accurate and reliable current measurement. Overall, the JPS series of split core current transformers offers a convenient and effective solution for current measurement in a variety of applications.



### Advantages

- IEEE/ANSI C57.13, Class 0.3/0.6 accuracy
- IEC 61869-2 Class 0.2S/0.5S accuracy
- Accessories options for installation (Terminal, plug-in, RJ12 port)

### Application

- ANSI C12.20 of class 0.2/0.5
- IEC 62053-22 of class 0.2S/0.5S
- IEC 61000-4-30 A ED3 for Power Quality Meter

### Standards

- UL Listed UL2808 (XOBA) : Pollution Degree: 3 CAT IV, 600 Vac
- UL/EN61010-1(PICQ) : Pollution Degree: 3 CAT IV, 600 Vac

Model	Rated Amps	Output	Accuracy	Internal Burden (Ohms)
JPS33N-250-100mA	250A	100mA	0.2/0.5%	47.4 Ω
JPS33N-300-100mA	300A	100mA	0.2/0.5%	68.2 Ω
JPS33N-400-100mA	400A	100mA	0.2/0.5%	116.6 Ω
JPS33N-500-100mA	500A	100mA	0.2/0.5%	162 Ω
JPS33N-600-100mA	600A	100mA	0.2/0.5%	237 Ω

### How to Use

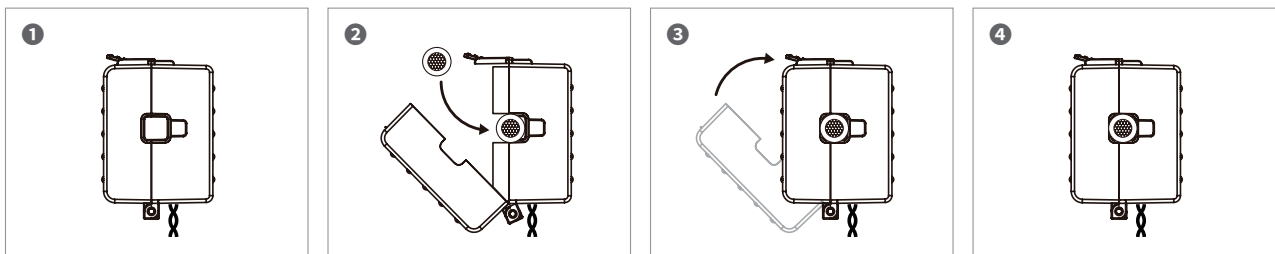

Please refer to "Split-core Current Transformer Installation Guide" for further details.



## 1. Specifications

- Accuracy : Class 0.5S
- System Voltage : 720 V (0.72 kV)
- Overload Withstand : 1.2 times rated current continuously
- Compliant with : IEC/EN 61869-2 & IEEE/ANSI C57.13
- Operating Temperature Range : -40°C to 70°C
- Relative Humidity : 0 to 90% non-condensing
- Test Voltage : 3 kV for 1 minute
- Frequency Range : 50/60 Hz
- Protection Level : 3.0V0-P
- Insulation Category : CAT III 1000 Vac, CAT IV 600 Vac
- Output Lead Wires :  
 Style : Two conductor, brown and yellow twisted pair (equivalent to about one #8 AWG 0.213" dia.), MTW, UL 1015  
 Standard length : 8 ft (2.44m), Gauge : #18 AWG, Voltage : 600Vac

### 1.1 Accuracy

- Ratio Error :  
 Accuracy 0.5% conforms to IEC 61869-2 & IEEE/ANSI C57.13 meets the measuring range from 1% to 120% of  $I_n$
- Phase Angle :  
 50/60 Hz – 0.0 to 2.0 degrees leading from 1% to 120% of rated current

#### Position Sensitivity

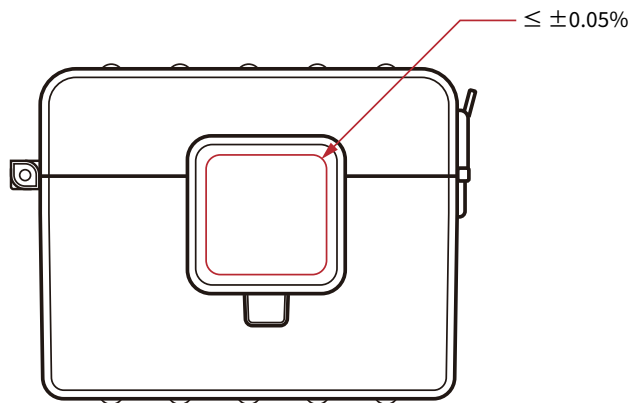

#### Shock and Air Gap Test

- Shock and Vibration Test Report(JPS33)

400A	
Phase error(°)	Linearity Error(%)
0.20	- 0.16
0.22	- 0.15



400A	
Phase error(°)	Linearity Error(%)
0.20	- 0.16
0.21	- 0.17

- Core Air Gap Test Report(JPS33)

400A	
Air gap : 2microns	
Phase error(°)	Linearity Error(%)
0.20	- 0.14



400A	
Air gap : 2.5microns	
Phase error(°)	Linearity Error(%)
0.22	- 0.18

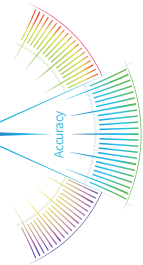

## Harmonic Graphs

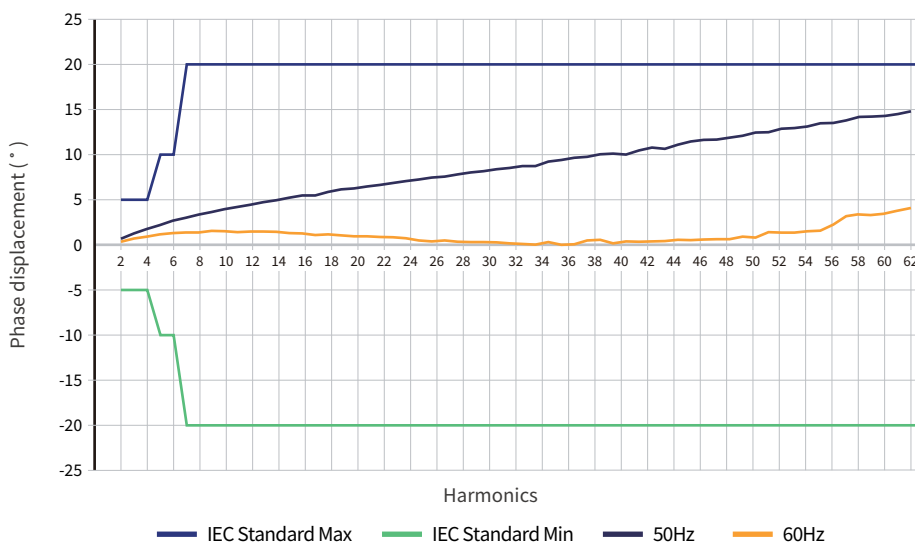
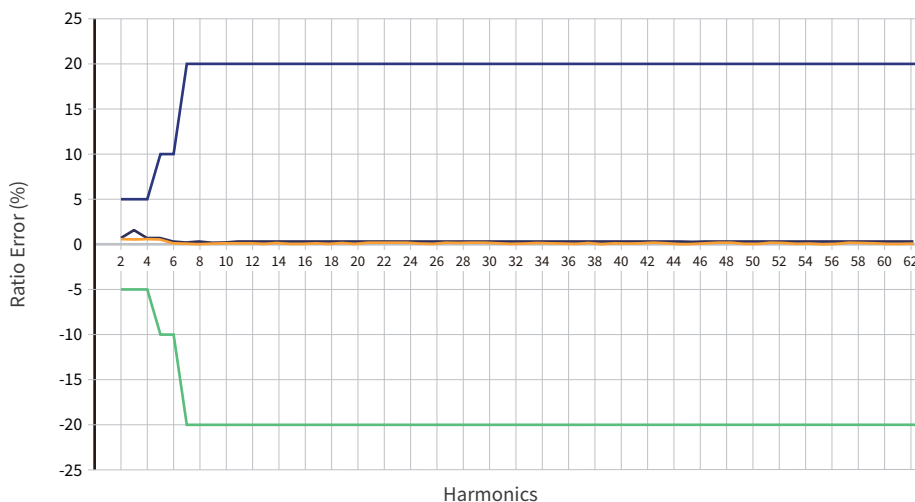

### 1.2 Regulatory

- CE
- UL Listed UL2808 (XOBA) : Pollution Degree: 3 CAT IV, 600 Vac
- UL/EN61010-1(PICQ) : Pollution Degree: 3 CAT IV, 600 Vac
- RoHs Compliant

### 1.3 Environmental

- Operating Temperature : -40°C to 70°C (-40°F to +158°F)
- Operating Humidity : Non-condensing, 0 to 95% relative humidity(RH)
- Operating Altitude : Up to 3000 m (9842 feet)
- Pollution Degree : 3 (harsh environment)
- Indoor Use : Suitable for indoor use
- Outdoor Use : Suitable for outdoor use when mounted in a NEMA 3R or 4 (IP 66) rated enclosure, provided the ambient temperature will not exceed 55°C (131°F)

### 1.4 Mechanical

- Width : 96mm
- Height : 77.5mm
- Thickness : 36mm
- Opening : 33mm
- Weight : 590g
- Core Nickel Core : high permeability ferrite
- Standard lead wire : 2.44m, 18AWG

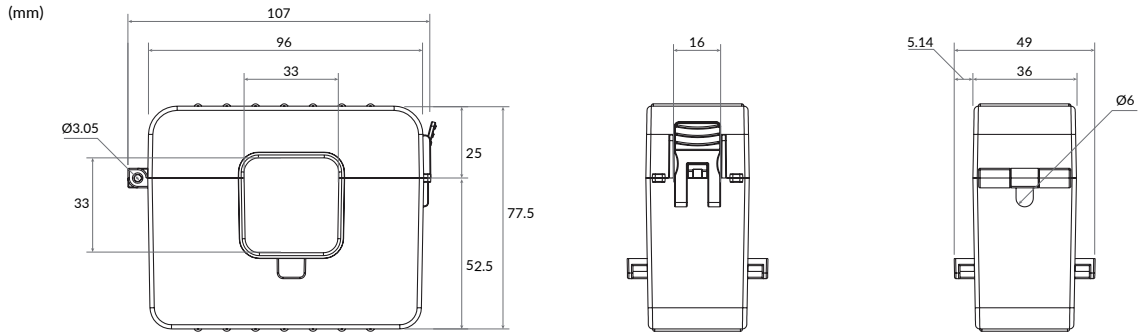

### 1.5 Labels

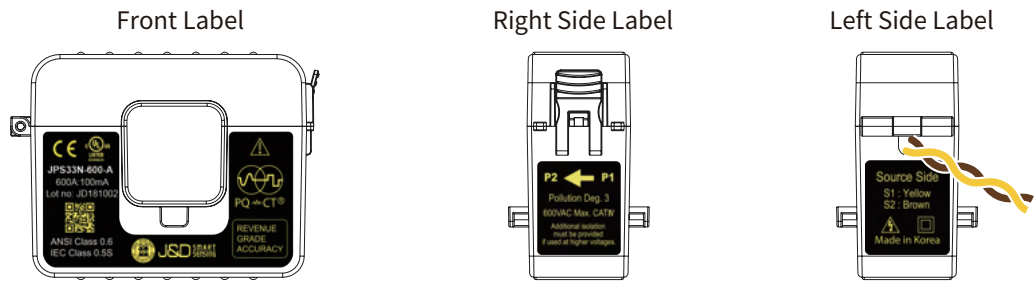

- QR code : <Model> ; <SerialNum> ; Scan QR code for Instruction Manual
- Orientation : Mount the CT referring to the right side label attached(P1->P2).

## 2. Typical Accuracy

- In the following graphs, a positive phase angle error indicates that the output of the CT leads the primary current.
- Graphs show typical performance at 25°C, 60 Hz
- Performance Graphs - The standard CT meets ANSI/IEEE C57.13 class 0.6 standard & IEC 61869-2 standard class 0.5

### 2.1 Schematic Diagram

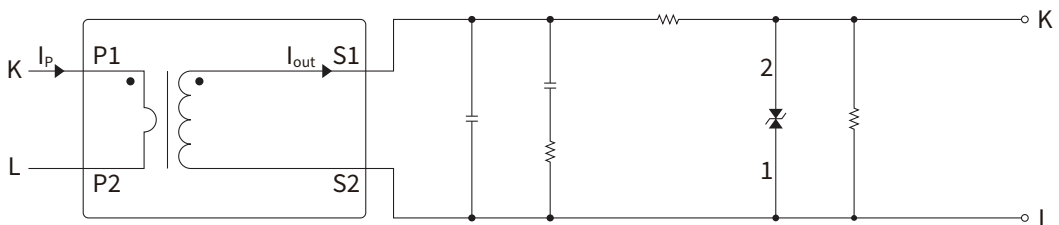

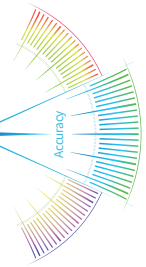

## 2.2 JPS33N-250-100mA

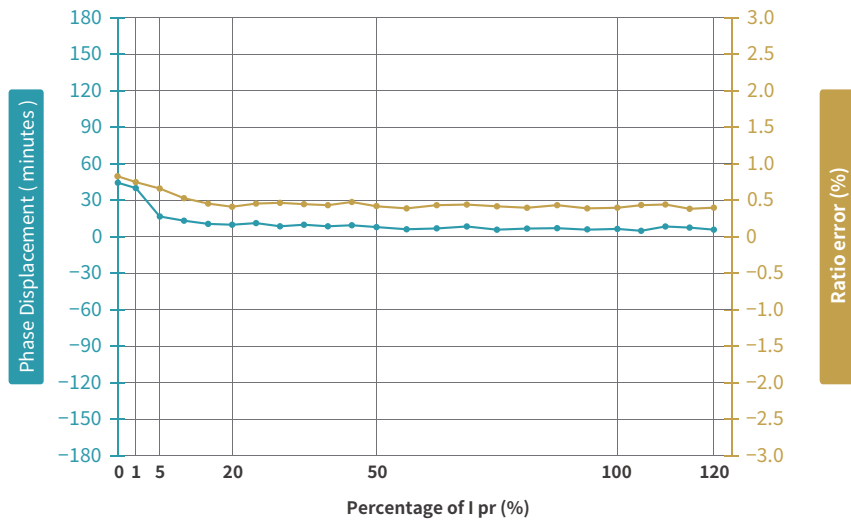

## 2.3 JPS33N-300-100mA

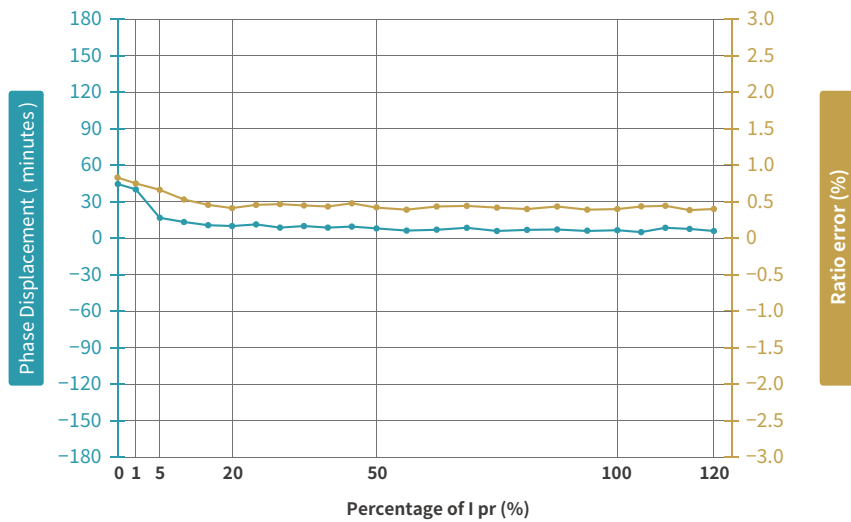

## 2.4 JPS33N-400-100mA

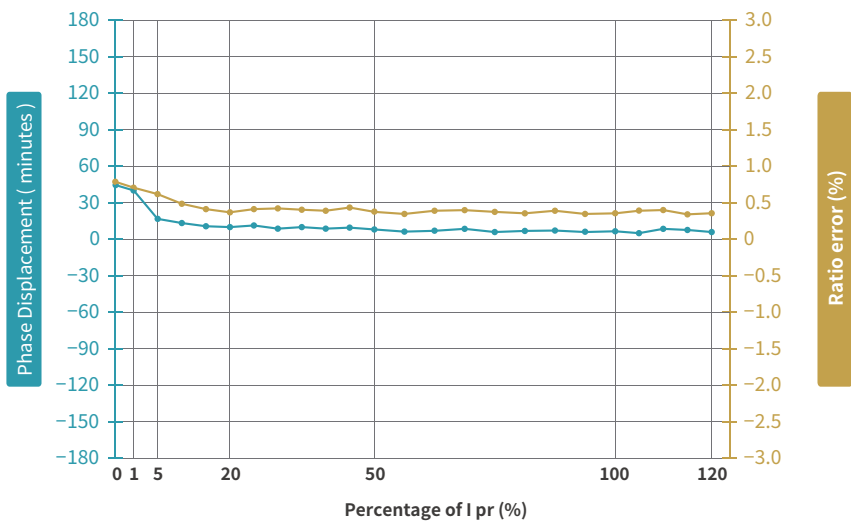

2.5 JPS33N-500-100mA

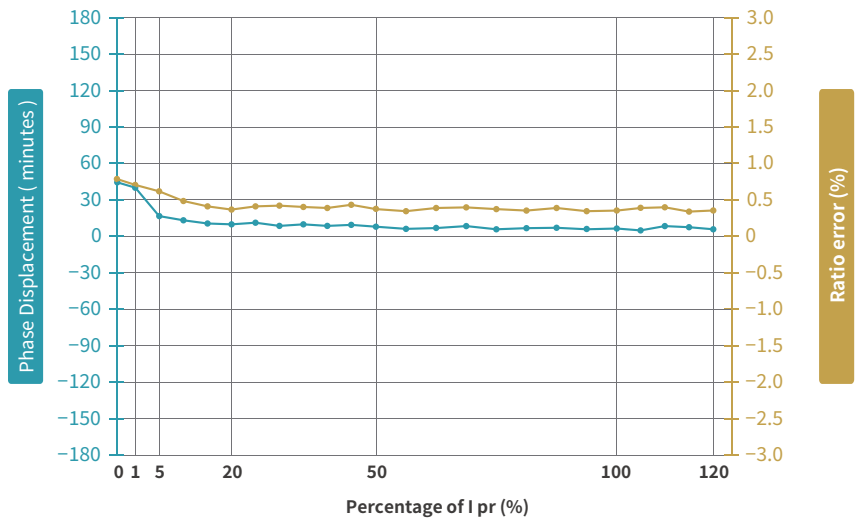

2.6 JPS33N-600-100mA

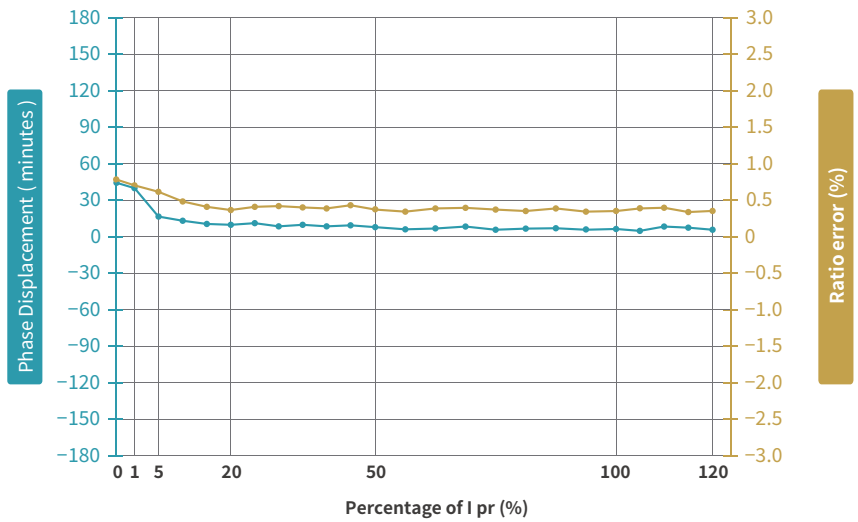

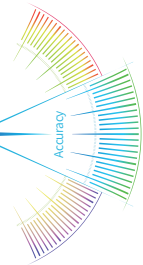

## Current Transformers JPS52N-XXXX-100mA SERIES

The JPS series of split core current transformers is designed for easy and efficient installation, making them ideal for use in both new construction and retrofit applications. The split core design enables quick and simple installation by allowing the CT to be easily opened and placed around the power cable. The JPS series also features enhanced durability, making them resistant to the effects of vibration and shock.

The JPS series of CTs can accurately measure the current flowing through the power line with Revenue grade accuracy. This makes them suitable for use in Power Quality measuring and Revenue Grade metering applications. The unique design of the JPS series is listed under UL 2808 and UL/EN 61010-1, allowing for field installation of the CT in manufactured subpanels and electrical cabinets while maintaining the UL rating and manufacturer warranty.

In addition, the JPS series CTs feature a secure locking mechanism that is noticed by a single click sound. This ensures that the CTs remain firmly in place and do not shift or move, providing accurate and reliable current measurement. Overall, the JPS series of split core current transformers offers a convenient and effective solution for current measurement in a variety of applications.

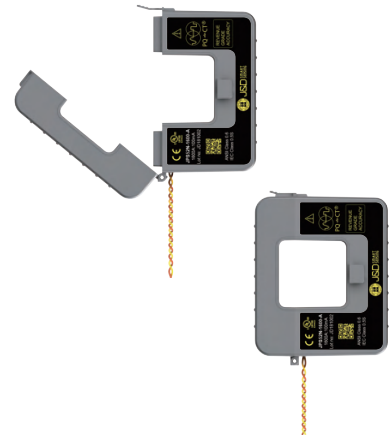

### Advantages

- IEEE/ANSI C57.13, Class 0.3/0.6 accuracy
- IEC 61869-2 Class 0.2S/0.5S accuracy
- Accessories options for installation (Terminal, plug-in, RJ12 port)

### Application

- ANSI C12.20 of class 0.2/0.5
- IEC 62053-22 of class 0.2S/0.5S
- IEC 61000-4-30 A ED3 for Power Quality Meter

### Standards

- UL Listed UL2808 (XOBA) : Pollution Degree: 3 CAT IV, 600 Vac
- UL/EN61010-1(PICQ) : Pollution Degree: 3 CAT IV, 600 Vac

Model	Rated Amps	Output	Accuracy	Internal Burden (Ohms)
JPS52N-400-100mA	400mA	100mA	0.2/0.5%	53 Ω
JPS52N-500-100mA	500mA	100mA	0.2/0.5%	80 Ω
JPS52N-600-100mA	600mA	100mA	0.2/0.5%	124 Ω
JPS52N-800-100mA	800mA	100mA	0.2/0.5%	199 Ω
JPS52N-1000-100mA	1000mA	100mA	0.2/0.5%	315 Ω
JPS52N-1200-100mA	1200mA	100mA	0.2/0.5%	581 Ω
JPS52N-1600-100mA	1600mA	100mA	0.2/0.5%	977 Ω

### How to Use

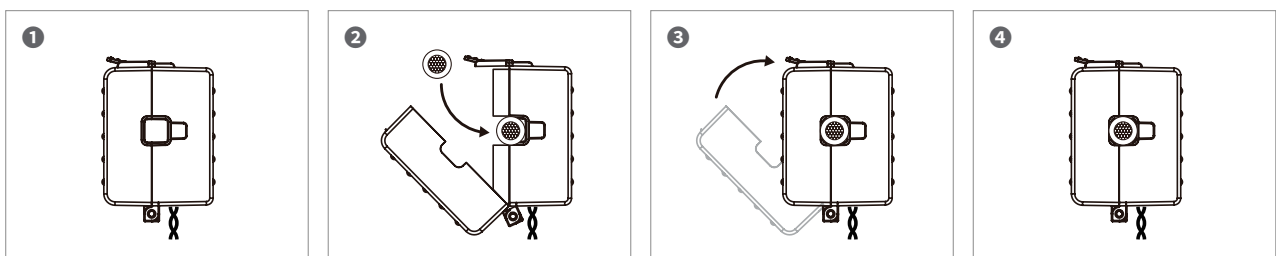

Please refer to "Split-core Current Transformer Installation Guide" for further details.

## 1. Specifications

- Accuracy : Class 0.5S
- System Voltage : 720 V (0.72 kV)
- Overload Withstand : 1.2 times rated current continuously
- Compliant with : IEC/EN 61869-2 & IEEE/ANSI C57.13
- Operating Temperature Range : -40°C to 70°C
- Relative Humidity : 0 to 90% non-condensing
- Test Voltage : 3 kV for 1 minute
- Frequency Range : 50/60 Hz
- Protection Level : 3.0V0-P
- Insulation Category : CAT III 1000 Vac, CAT IV 600 Vac
- Output Lead Wires :  
 Style : Two conductor, brown and yellow twisted pair (equivalent to about one #8 AWG 0.213" dia.), MTW, UL 1015  
 Standard length : 8 ft (2.44m), Gauge : #18 AWG, Voltage : 600Vac

### 1.1 Accuracy

- Ratio Error :  
 Accuracy 0.5% conforms to IEC 61869-2 & IEEE/ANSI C57.13 meets the measuring range from 1% to 120% of  $I_n$
- Phase Angle :  
 50/60 Hz – 0.0 to 2.0 degrees leading from 1% to 120% of rated current

#### Position Sensitivity

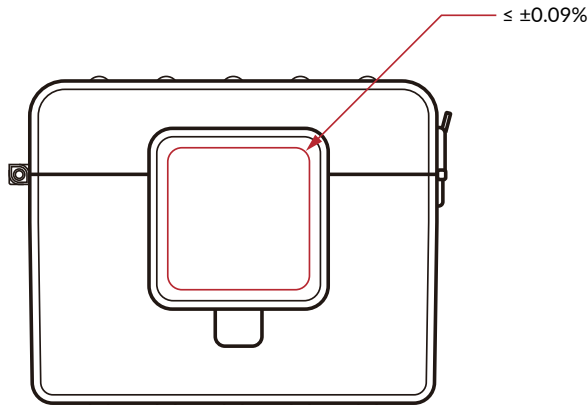

#### Shock and Air Gap Test

- Shock and Vibration Test Report(JPS52)

1000A		→	1000A	
Phase error(°)	Linearity Error(%)		Phase error(°)	Linearity Error(%)
0.22	- 0.16		0.20	- 0.16
0.24	- 0.17		0.23	- 0.19

- Core Air Gap Test Report(JPS52)

1000A		→	1000A	
Air gap : 2microns			Air gap : 2.5microns	
Phase error(°)	Linearity Error(%)		Phase error(°)	Linearity Error(%)
0.22	- 0.16		0.22	- 0.18



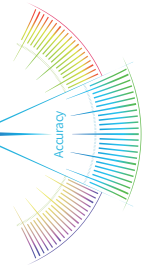

## Harmonic Graphs

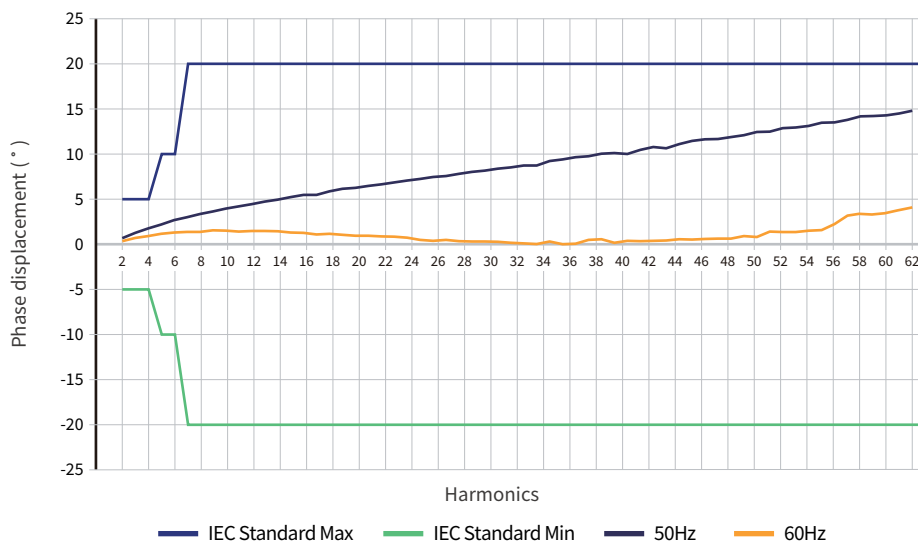
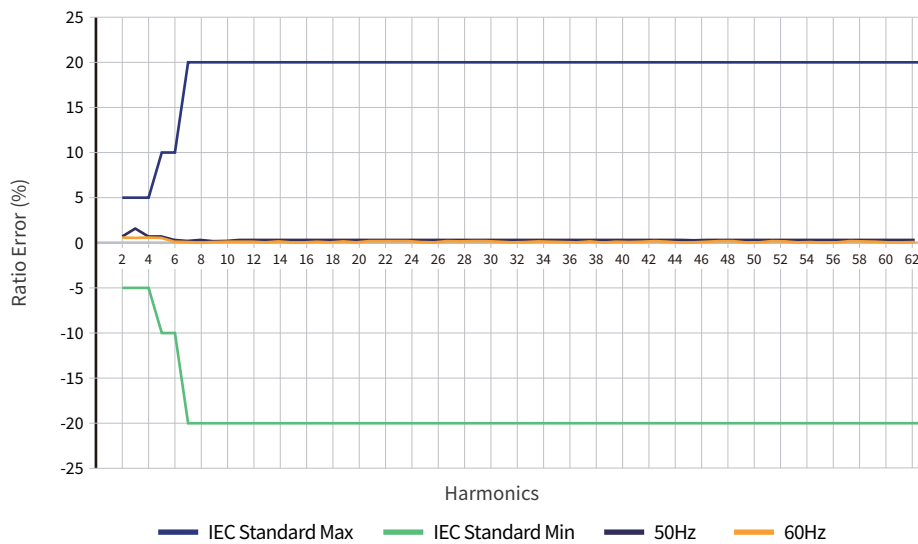

### 1.2 Regulatory

- CE
- UL Listed UL2808 (XOBA) : Pollution Degree: 3 CAT IV, 600 Vac
- UL/EN61010-1(PICQ) : Pollution Degree: 3 CAT IV, 600 Vac
- RoHs Compliant

### 1.3 Environmental

- Operating Temperature : -40°C to 70°C (-40°F to +158°F)
- Operating Humidity : Non-condensing, 0 to 95% relative humidity(RH)
- Operating Altitude : Up to 3000 m (9842 feet)
- Pollution Degree : 3 (harsh environment)
- Indoor Use : Suitable for indoor use
- Outdoor Use : Suitable for outdoor use when mounted in a NEMA 3R or 4 (IP 66) rated enclosure, provided the ambient temperature will not exceed 55°C (131°F)

### 1.4 Mechanical

- Width : 125mm
- Height : 103.5mm
- Thickness : 41mm
- Opening : 52mm
- Weight : 970g
- Core Nickel Core : high permeability ferrite
- Standard lead wire : 2.44m, 18AWG

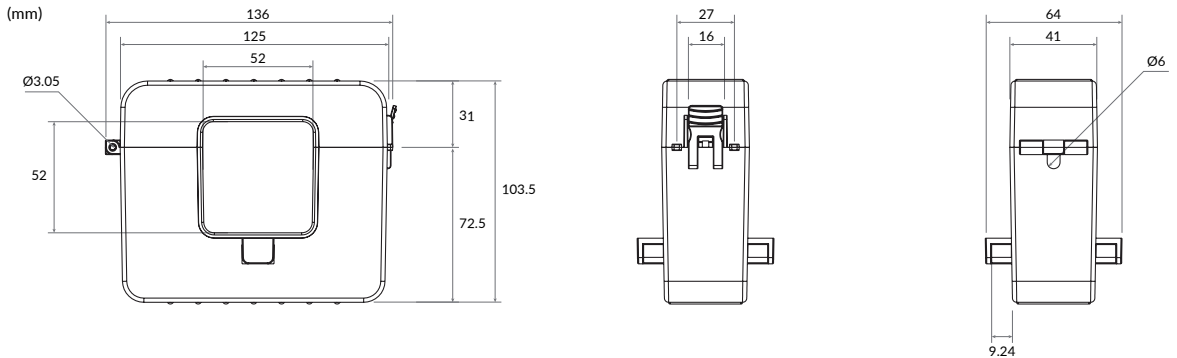

### 1.5 Labels



- QR code : <Model> ; <SerialNum> ; Scan QR code for Instruction Manual
- Orientation : Mount the CT referring to the right side label attached(P1->P2).

## 2. Typical Accuracy

- In the following graphs, a positive phase angle error indicates that the output of the CT leads the primary current.
- Graphs show typical performance at 25°C, 60 Hz
- Performance Graphs - The standard CT meets ANSI/IEEE C57.13 class 0.6 standard & IEC 61869-2 standard class 0.5

### 2.1 Schematic Diagram

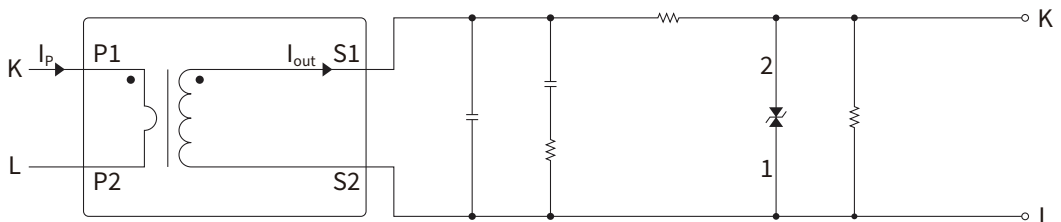

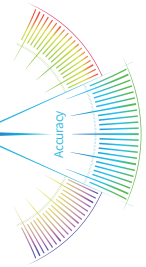

## 2.2 JPS52N-400-100mA

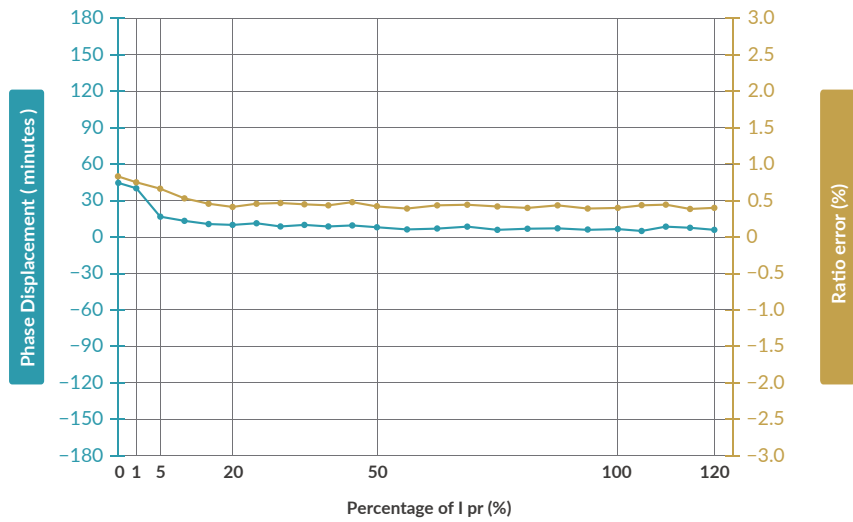

## 2.3 JPS52N-500-100mA

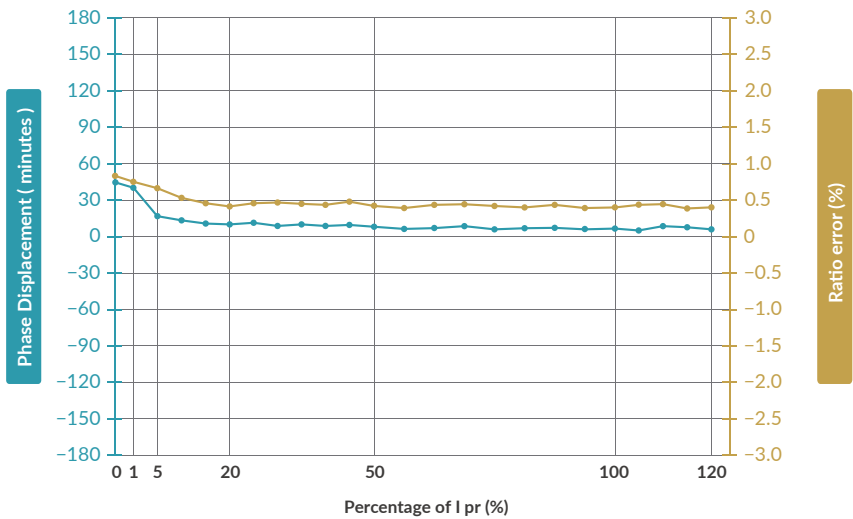

## 2.4 JPS52N-600-100mA

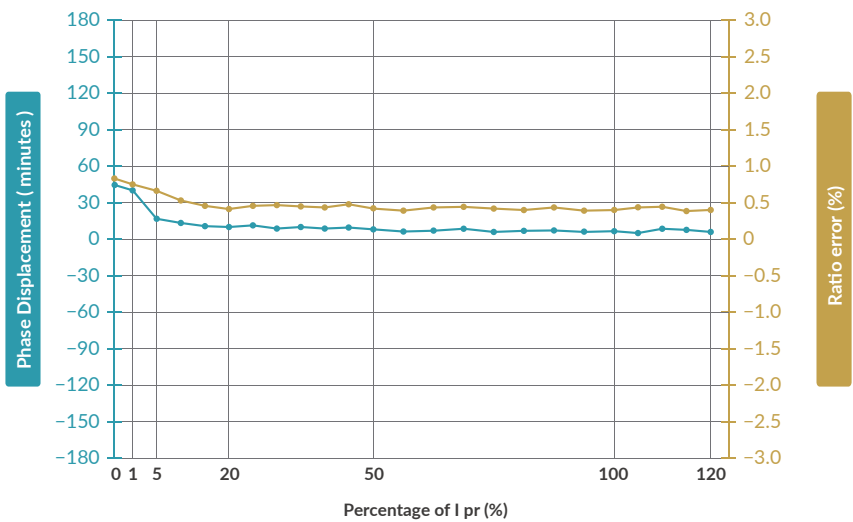

2.5 JPS52N-800-100mA

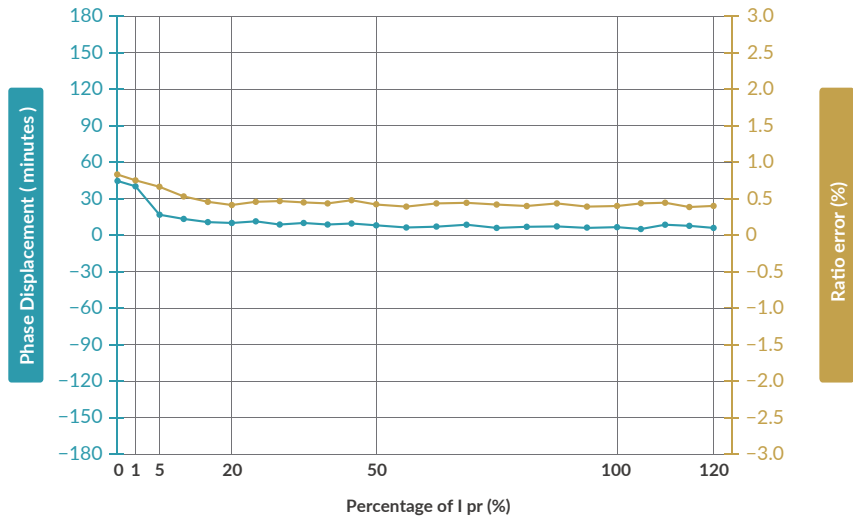

2.6 JPS52N-1000-100mA

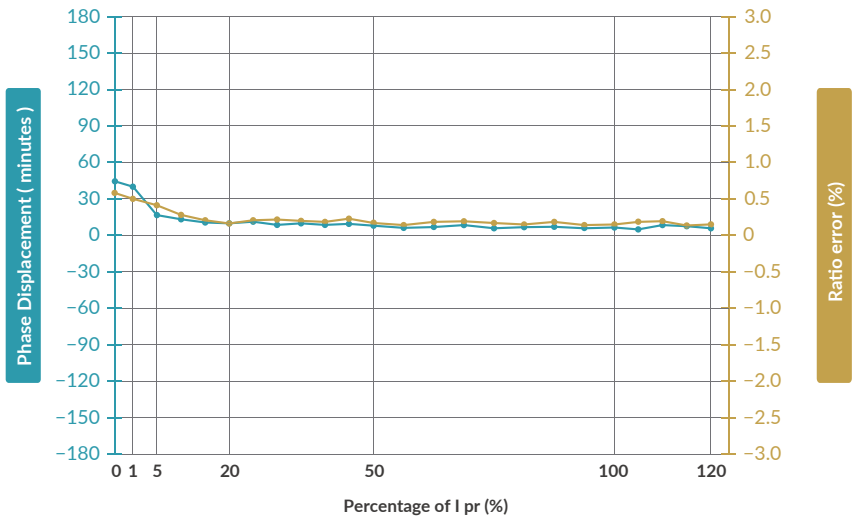

2.7 JPS52N-1200-100mA

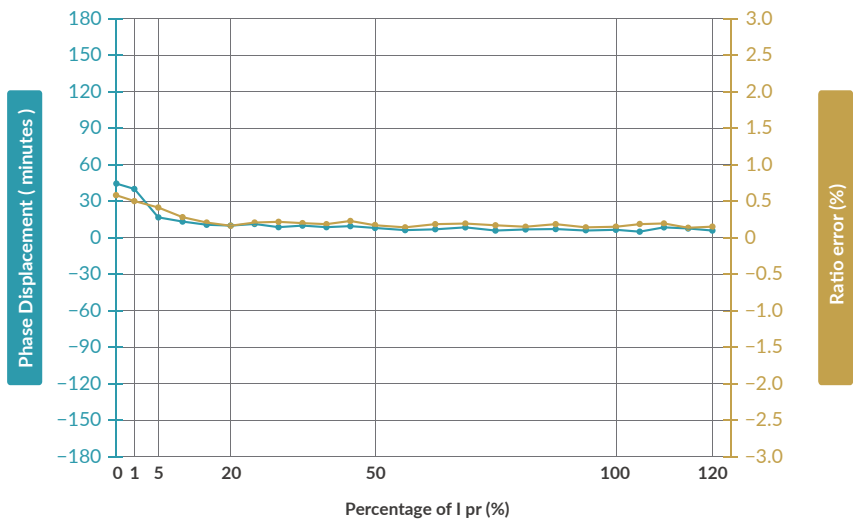

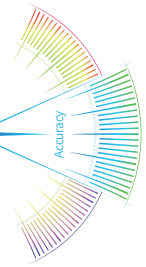

## 2.8 JPS52N-1600-100mA

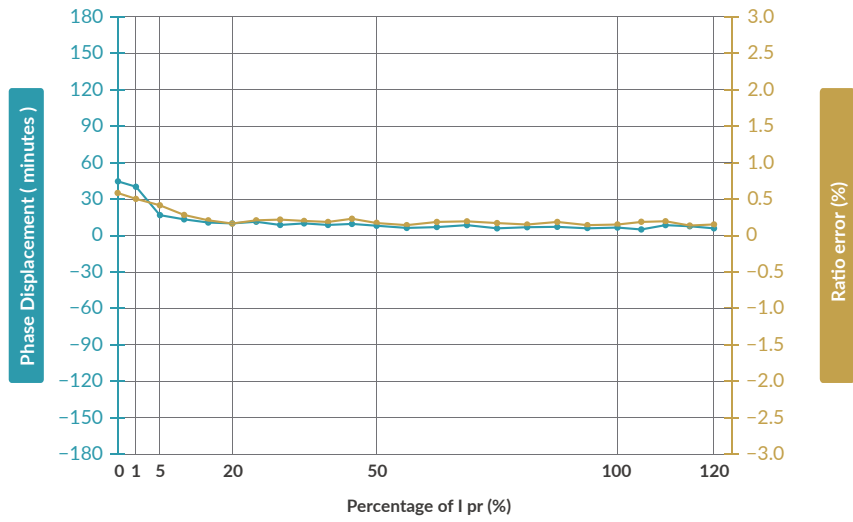



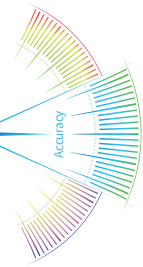

## Current Transformers JPS10N-XXXX-333mV SERIES

The JPS series of split core current transformers is designed for easy and efficient installation, making them ideal for use in both new construction and retrofit applications. The split core design enables quick and simple installation by allowing the CT to be easily opened and placed around the power cable. The JPS series also features enhanced durability, making them resistant to the effects of vibration and shock.

The JPS series of CTs can accurately measure the current flowing through the power line with Revenue grade accuracy. This makes them suitable for use in Power Quality measuring and Revenue Grade metering applications. The unique design of the JPS series is listed under UL 2808 and UL/EN 61010-1, allowing for field installation of the CT in manufactured subpanels and electrical cabinets while maintaining the UL rating and manufacturer warranty.

In addition, the JPS series CTs feature a secure locking mechanism that is noticed by a single click sound. This ensures that the CTs remain firmly in place and do not shift or move, providing accurate and reliable current measurement. Overall, the JPS series of split core current transformers offers a convenient and effective solution for current measurement in a variety of applications.

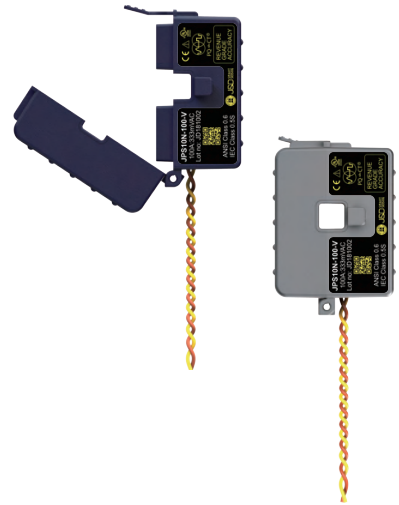

### Advantages

- IEEE/ANSI C57.13, Class 0.3/0.6 accuracy
- IEC 61869-2 Class 0.2S/0.5S accuracy
- Accessories options for installation (Terminal, plug-in, RJ12 port)

### Application

- ANSI C12.20 of class 0.2/0.5
- IEC 62053-22 of class 0.2S/0.5S
- IEC 61000-4-30 A ED3 for Power Quality Meter

### Standards

- UL Listed UL2808 (XOBA) : Pollution Degree: 3 CAT IV, 600 Vac
- UL/EN61010-1(PICQ) : Pollution Degree: 3 CAT IV, 600 Vac

Model	Rated Amps	Output	Accuracy	Internal Burden (Ohms)
JPS10N-005-333mV	5A	333mV	0.5%	268.14Ω
JPS10N-015-333mV	15A	333mV	0.5%	89.27Ω
JPS10N-020-333mV	20A	333mV	0.5%	66.63Ω
JPS10N-030-333mV	30A	333mV	0.5%	44.74Ω
JPS10N-050-333mV	50A	333mV	0.5%	26.77Ω
JPS10N-070-333mV	70A	333mV	0.5%	19.07Ω
JPS10N-100-333mV	100A	333mV	0.2/0.5%	13.39Ω

### How to Use

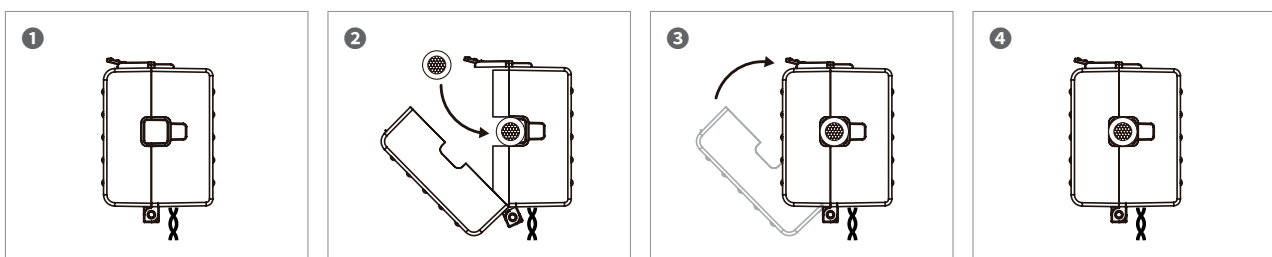

Please refer to "Split-core Current Transformer Installation Guide" for further details.



## 1. Specifications

- Accuracy : Class 0.5S
- System Voltage : 720 V (0.72 kV)
- Overload Withstand : 1.2 times rated current continuously
- Compliant with : IEC/EN 61869-2 & IEEE/ANSI C57.13
- Operating Temperature Range : -40°C to 70°C
- Relative Humidity : 0 to 90% non-condensing
- Test Voltage : 3 kV for 1 minute
- Frequency Range : 50/60 Hz
- Protection Level : 3.0V0-P
- Insulation Category : CAT III 1000 Vac, CAT IV 600 Vac
- Output Lead Wires :  
 Style : Two conductor, brown and yellow twisted pair (equivalent to about one #8 AWG 0.213" dia.), MTW, UL 1015  
 Standard length : 8 ft (2.44m), Gauge : #18 AWG, Voltage : 600Vac

### 1.1 Accuracy

- Ratio Error :  
 Accuracy 0.5% conforms to IEC 61869-2 & IEEE/ANSI C57.13 meets the measuring range from 1% to 120% of  $I_n$
- Phase Angle :  
 50/60 Hz – 0.0 to 2.0 degrees leading from 1% to 120% of rated current

#### Position Sensitivity

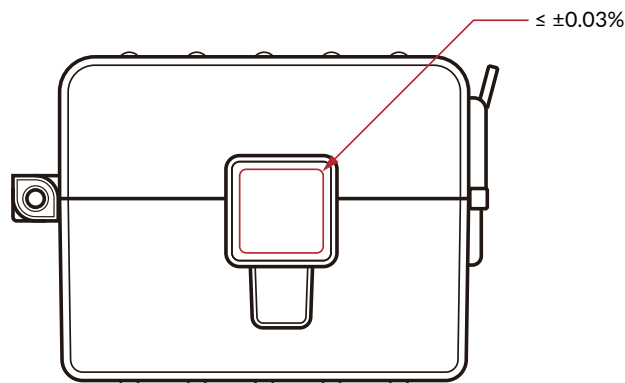

#### Shock and Air Gap Test

- Shock and Vibration Test Report(JPS10)

100A	
Phase error(°)	Linearity Error(%)
0.21	- 0.15
0.23	- 0.16



100A	
Phase error(°)	Linearity Error(%)
0.21	- 0.17
0.22	- 0.18

- Core Air Gap Test Report(JPS10)

100A	
Air gap : 2microns	
Phase error(°)	Linearity Error(%)
0.21	- 0.15



100A	
Air gap : 2.5microns	
Phase error(°)	Linearity Error(%)
0.21	- 0.17

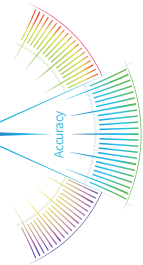

## Harmonic Graphs

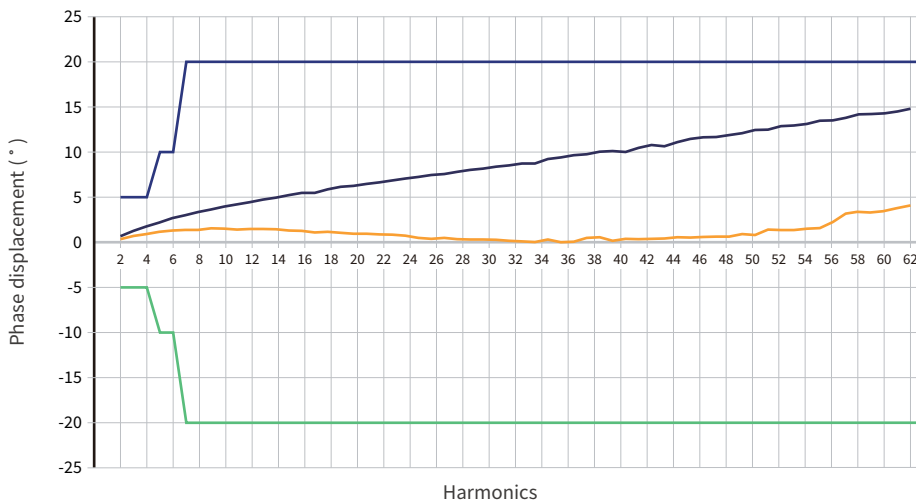
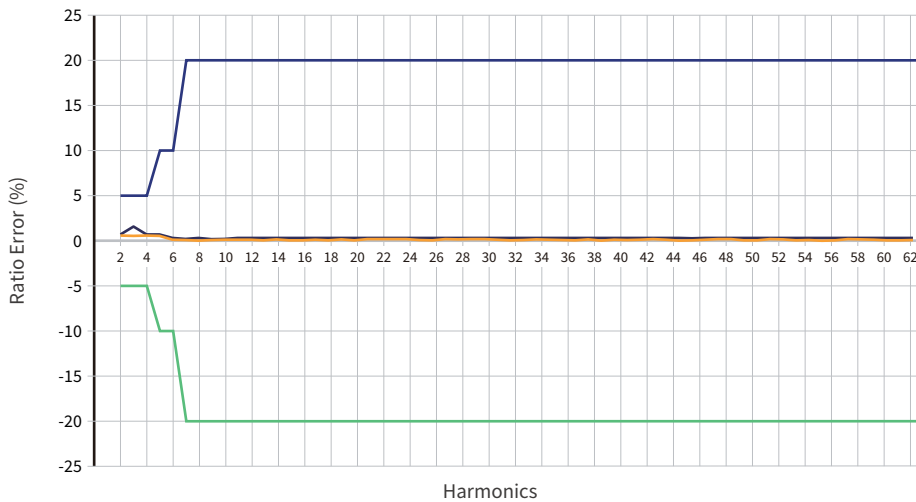

### 1.2 Regulatory

- CE
- UL Listed UL2808 (XOBA) : Pollution Degree: 3 CAT IV, 600 Vac
- UL/EN61010-1(PICQ) : Pollution Degree: 3 CAT IV, 600 Vac
- RoHs Compliant

### 1.3 Environmental

- **Operating Temperature** : -40°C to 70°C (-40°F to +158°F)
- **Operating Humidity** : Non-condensing, 0 to 95% relative humidity(RH)
- **Operating Altitude** : Up to 3000 m (9842 feet)
- **Pollution Degree** : 3 (harsh environment)
- **Indoor Use** : Suitable for indoor use
- **Outdoor Use** : Suitable for outdoor use when mounted in a NEMA 3R or 4 (IP 66) rated enclosure, provided the ambient temperature will not exceed 55°C (131°F)

### 1.4 Mechanical

- Width : 61mm
- Height : 48mm
- Thickness : 35mm
- Opening : 10mm
- Weight : 230g
- Core Nickel Core : high permeability ferrite
- Standard lead wire : 2.44m, 18AWG

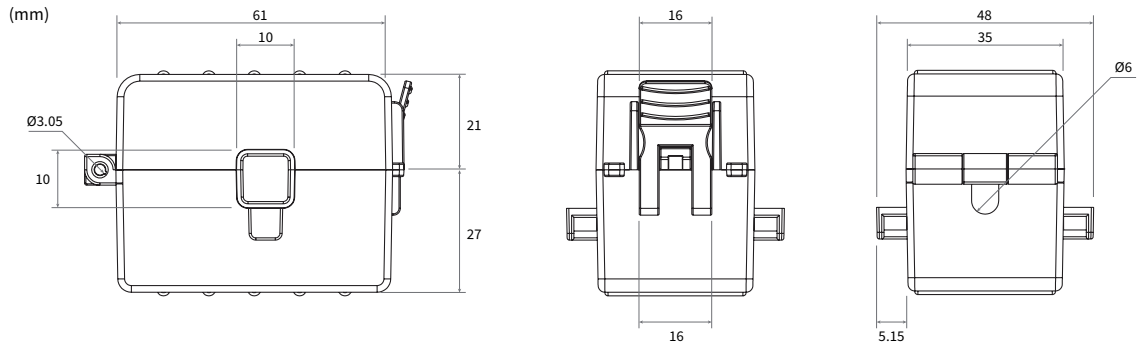

### 1.5 Labels

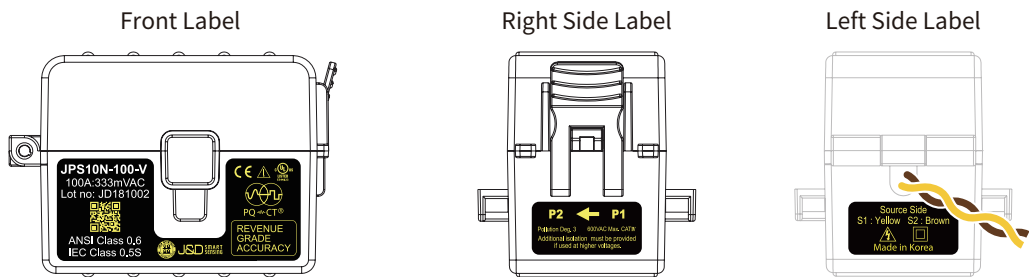

- QR code : <Model> ; <SerialNum> ; Scan QR code for Instruction Manual
- Orientation : Mount the CT referring to the right side label attached(P1->P2).

## 2. Typical Accuracy

- In the following graphs, a positive phase angle error indicates that the output of the CT leads the primary current.
- Graphs show typical performance at 25°C, 60 Hz
- Performance Graphs - The standard CT meets ANSI/IEEE C57.13 class 0.6 standard & IEC 61869-2 standard class 0.5

### 2.1 Schematic Diagram

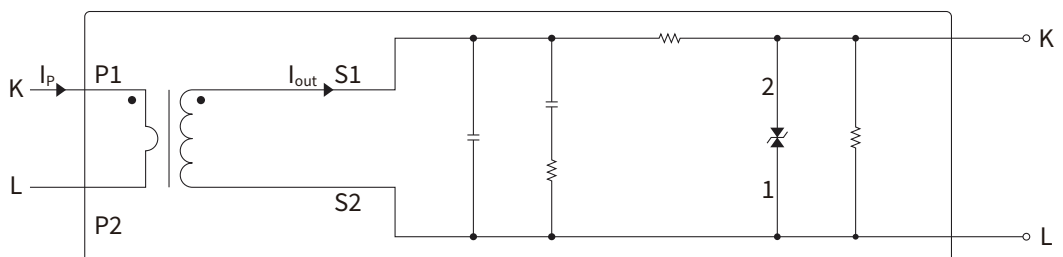

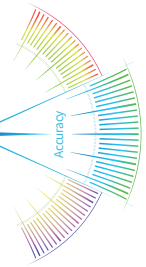

### 2.2 JPS10N-005-333mV

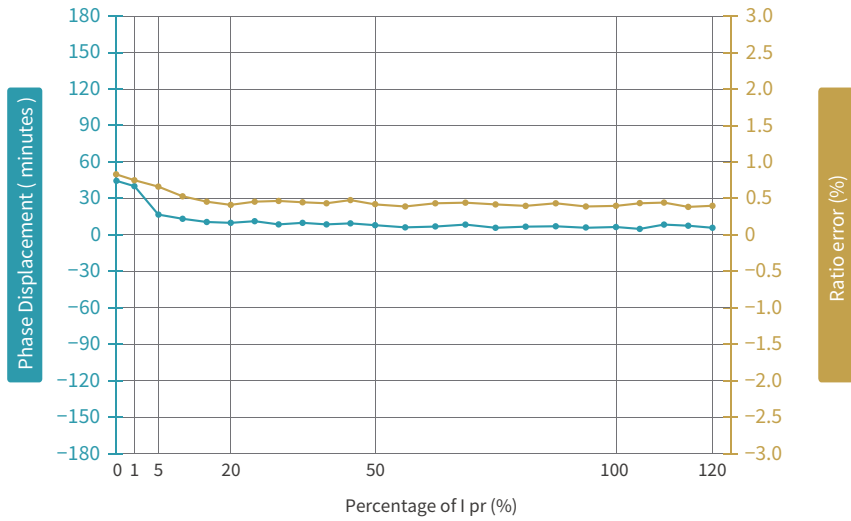

### 2.3 JPS10N-015-333mV

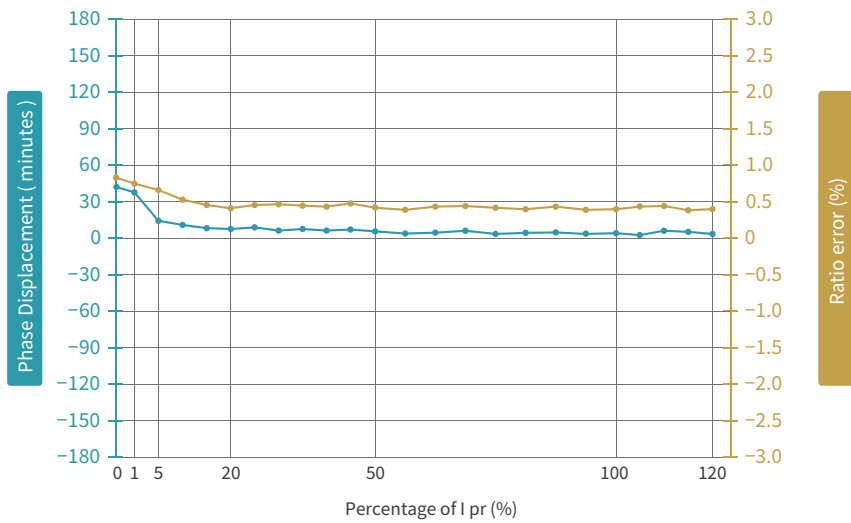

### 2.4 JPS10N-020-333mV

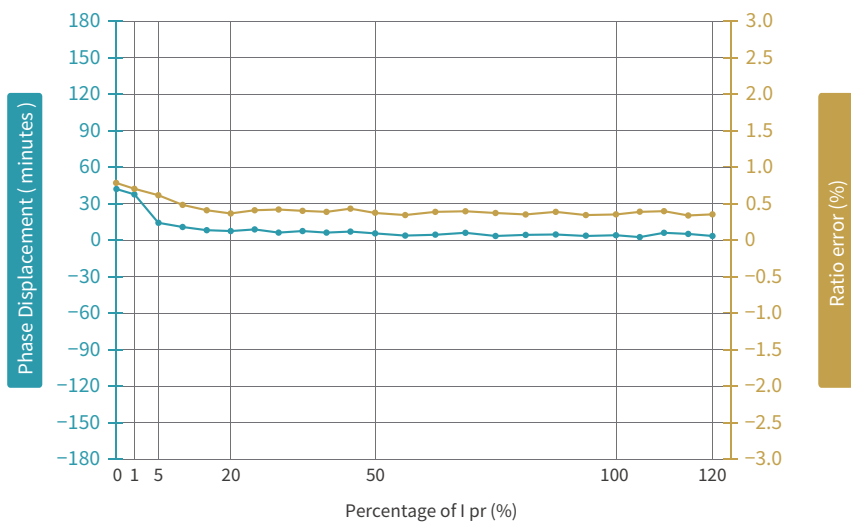

2.5 JPS10N-030-333mV

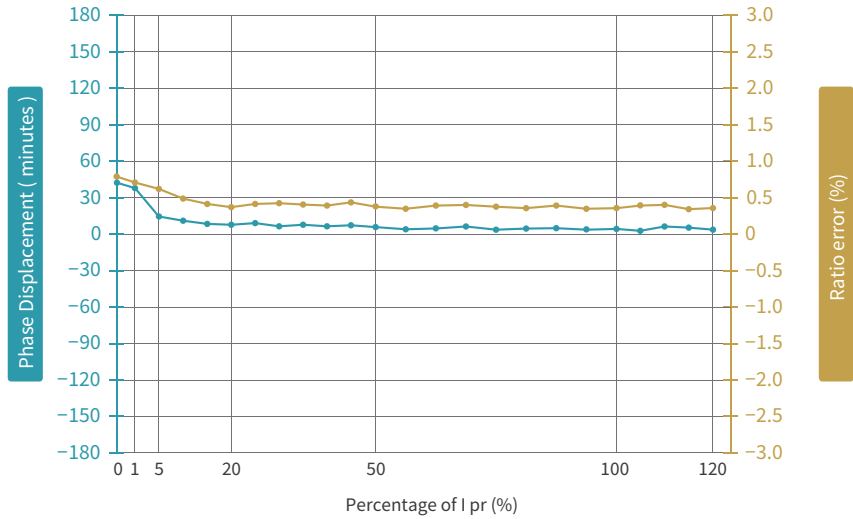

2.6 JPS10N-050-333mV

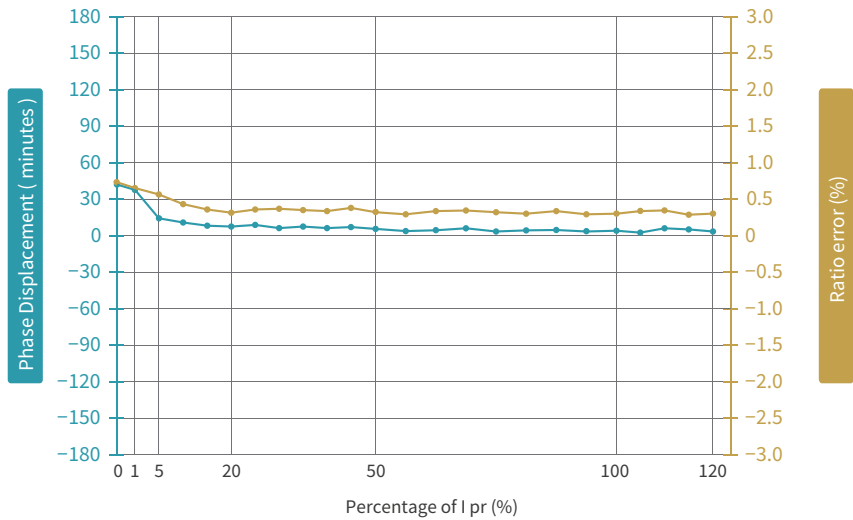

2.7 JPS10N-070-333mV

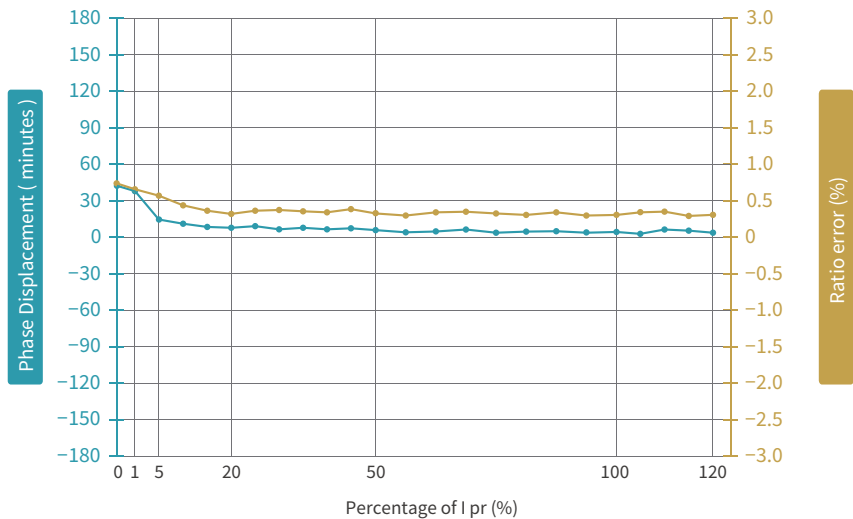

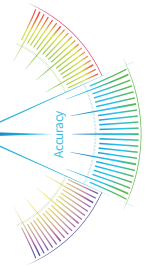

## 2.8 JPS10N-100-333mV

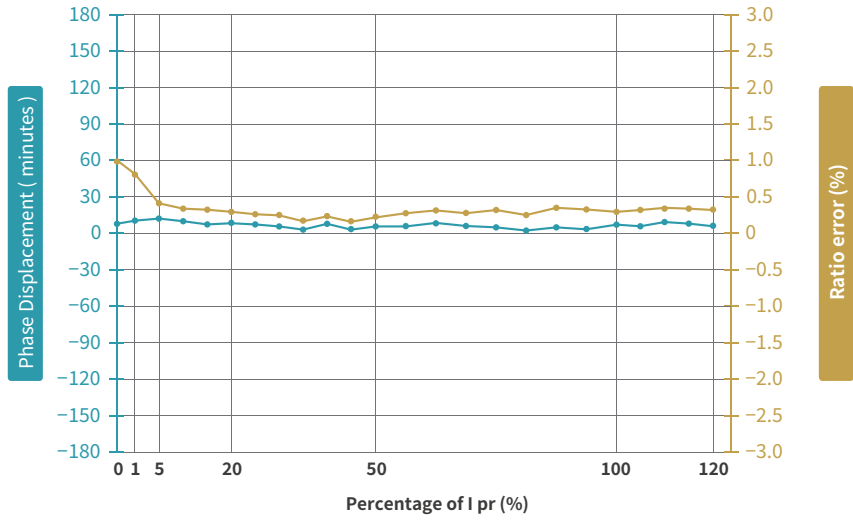



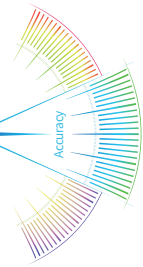

## Current Transformers JPS20N-XXXX-333mV SERIES

The JPS series of split core current transformers is designed for easy and efficient installation, making them ideal for use in both new construction and retrofit applications. The split core design enables quick and simple installation by allowing the CT to be easily opened and placed around the power cable. The JPS series also features enhanced durability, making them resistant to the effects of vibration and shock.

The JPS series of CTs can accurately measure the current flowing through the power line with Revenue grade accuracy. This makes them suitable for use in Power Quality measuring and Revenue Grade metering applications. The unique design of the JPS series is listed under UL 2808 and UL/EN 61010-1, allowing for field installation of the CT in manufactured subpanels and electrical cabinets while maintaining the UL rating and manufacturer warranty.

In addition, the JPS series CTs feature a secure locking mechanism that is noticed by a single click sound. This ensures that the CTs remain firmly in place and do not shift or move, providing accurate and reliable current measurement. Overall, the JPS series of split core current transformers offers a convenient and effective solution for current measurement in a variety of applications.

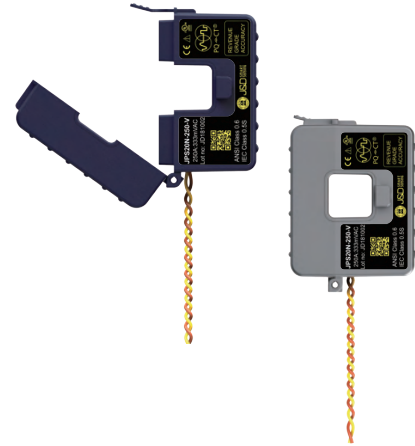

### Advantages

- IEEE/ANSI C57.13, Class 0.3/0.6 accuracy
- IEC 61869-2 Class 0.2S/0.5S accuracy
- Accessories options for installation (Terminal, plug-in, RJ12 port)

### Application

- ANSI C12.20 of class 0.2/0.5
- IEC 62053-22 of class 0.2S/0.5S
- IEC 61000-4-30 A ED3 for Power Quality Meter

### Standards

- UL Listed UL2808 (XOBA) : Pollution Degree: 3 CAT IV, 600 Vac
- UL/EN61010-1(PICQ) : Pollution Degree: 3 CAT IV, 600 Vac

Model	Rated Amps	Output	Accuracy	Internal Burden (Ohms)
JPS20N-005-333mV	5A	333mV	0.5%	268.14Ω
JPS20N-015-333mV	15A	333mV	0.5%	89.27Ω
JPS20N-020-333mV	20A	333mV	0.5%	66.63Ω
JPS20N-030-333mV	30A	333mV	0.5%	44.74Ω
JPS20N-050-333mV	50A	333mV	0.5%	26.77Ω
JPS20N-070-333mV	70A	333mV	0.5%	19.07Ω
JPS20N-100-333mV	100A	333mV	0.2/0.5%	13.39Ω
JPS20N-125-333mV	125A	333mV	0.2/0.5%	11.16Ω
JPS20N-150-333mV	150A	333mV	0.2/0.5%	8.94Ω
JPS20N-200-333mV	200A	333mV	0.2/0.5%	6.69Ω
JPS20N-250-333mV	250A	333mV	0.2/0.5%	5.35Ω

### How to Use

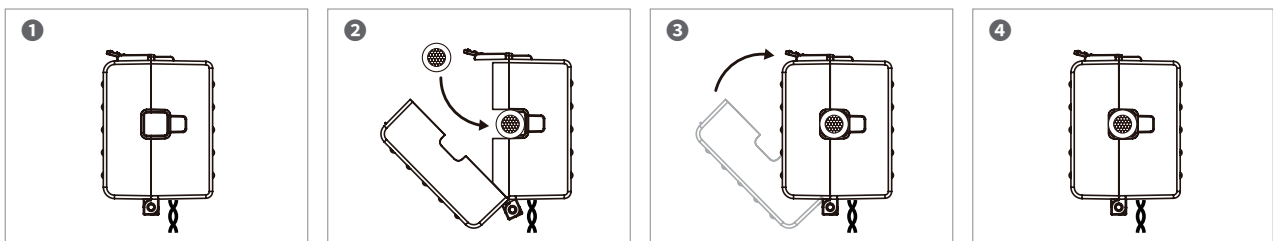

Please refer to "Split-core Current Transformer Installation Guide" for further details.



## 1. Specifications

- Accuracy : Class 0.5S
- System Voltage : 720 V (0.72 kV)
- Overload Withstand : 1.2 times rated current continuously
- Compliant with : IEC/EN 61869-2 & IEEE/ANSI C57.13
- Operating Temperature Range : -40°C to 70°C
- Relative Humidity : 0 to 90% non-condensing
- Test Voltage : 3 kV for 1 minute
- Frequency Range : 50/60 Hz
- Protection Level : 3.0V0-P
- Insulation Category : CAT III 1000 Vac, CAT IV 600 Vac
- Output Lead Wires :  
 Style : Two conductor, brown and yellow twisted pair (equivalent to about one #8 AWG 0.213" dia.), MTW, UL 1015  
 Standard length : 8 ft (2.44m), Gauge : #18 AWG, Voltage : 600Vac

### 1.1 Accuracy

- Ratio Error :  
 Accuracy 0.5% conforms to IEC 61869-2 & IEEE/ANSI C57.13 meets the measuring range from 1% to 120% of  $I_n$
- Phase Angle :  
 50/60 Hz – 0.0 to 2.0 degrees leading from 1% to 120% of rated current

#### Position Sensitivity

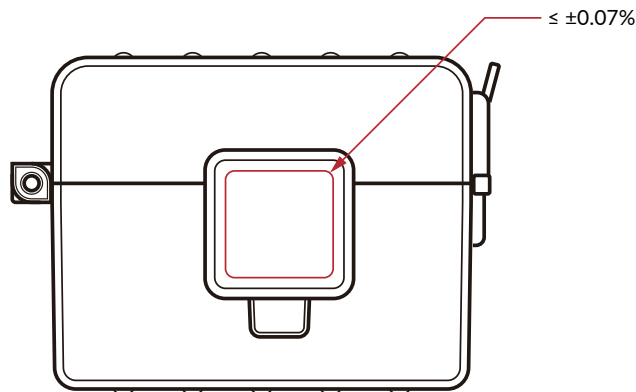

#### Shock and Air Gap Test

- Shock and Vibration Test Report(JPS20)

200A	
Phase error(°)	Linearity Error(%)
0.20	- 0.14
0.22	- 0.15



200A	
Phase error(°)	Linearity Error(%)
0.20	- 0.16
0.22	- 0.17

- Core Air Gap Test Report(JPS20)

200A	
Air gap : 2microns	
Phase error(°)	Linearity Error(%)
0.20	- 0.14



200A	
Air gap : 2.5microns	
Phase error(°)	Linearity Error(%)
0.20	- 0.16

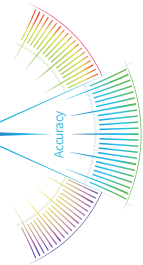

## Harmonic Graphs

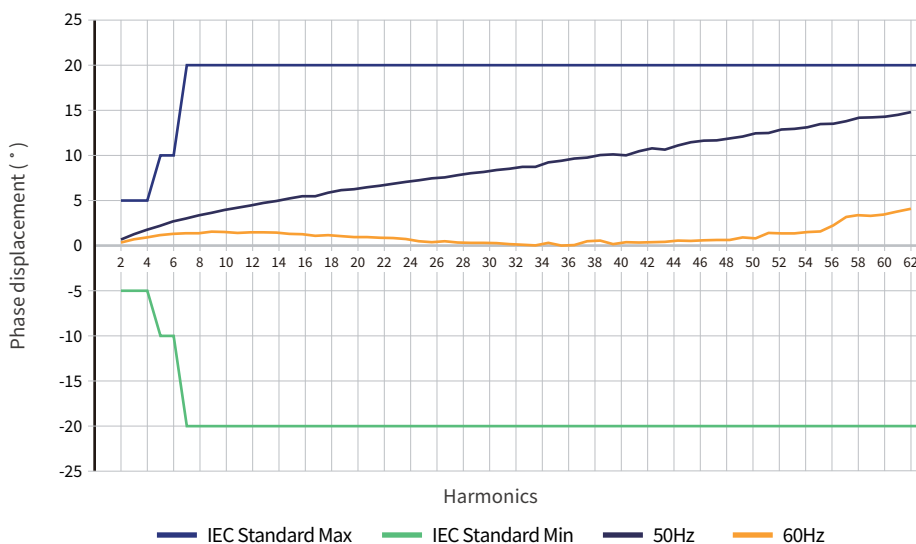
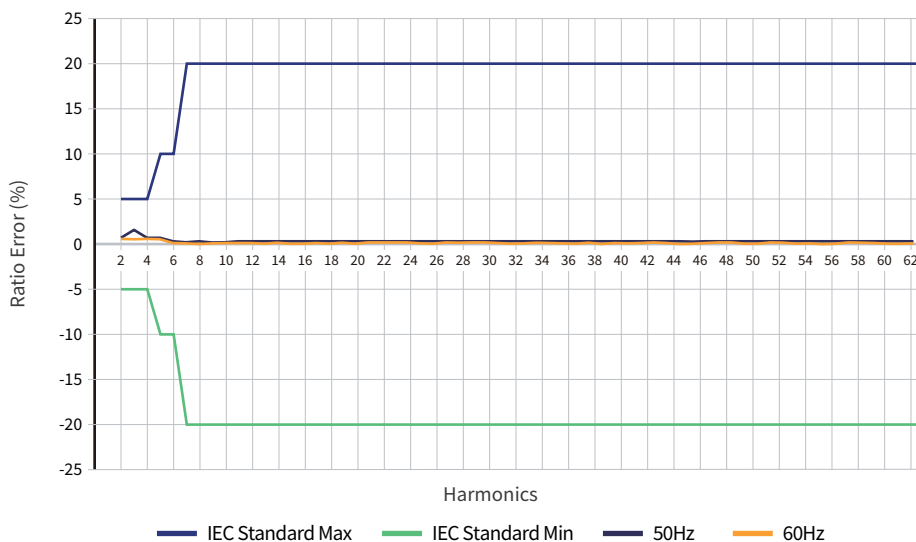

### 1.2 Regulatory

- CE
- UL Listed UL2808 (XOBA) : Pollution Degree: 3 CAT IV, 600 Vac
- UL/EN61010-1(PICQ) : Pollution Degree: 3 CAT IV, 600 Vac
- RoHs Compliant

### 1.3 Environmental

- **Operating Temperature** : -40°C to 70°C (-40°F to +158°F)
- **Operating Humidity** : Non-condensing, 0 to 95% relative humidity(RH)
- **Operating Altitude** : Up to 3000 m (9842 feet)
- **Pollution Degree** : 3 (harsh environment)
- **Indoor Use** : Suitable for indoor use
- **Outdoor Use** : Suitable for outdoor use when mounted in a NEMA 3R or 4 (IP 66) rated enclosure, provided the ambient temperature will not exceed 55°C (131°F)

### 1.4 Mechanical

- Width : 71.5mm
- Height : 58mm
- Thickness : 35mm
- Opening : 20mm
- Weight : 360g
- Core Nickel Core : high permeability ferrite
- Standard lead wire : 2.44m, 18AWG

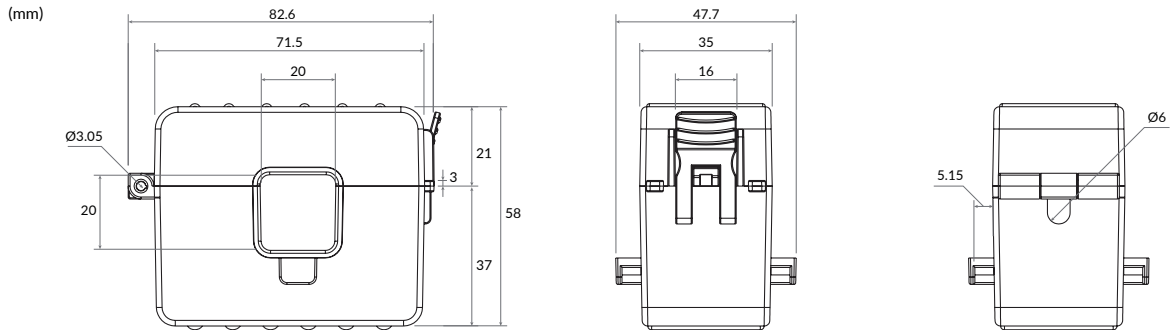

### 1.5 Labels



- QR code : <Model> ; <SerialNum> ; Scan QR code for Instruction Manual
- Orientation : Mount the CT referring to the right side label attached(P1->P2).

## 2. Typical Accuracy

- In the following graphs, a positive phase angle error indicates that the output of the CT leads the primary current.
- Graphs show typical performance at 25°C, 60 Hz
- Performance Graphs - The standard CT meets ANSI/IEEE C57.13 class 0.6 standard & IEC 61869-2 standard class 0.5

### 2.1 Schematic Diagram

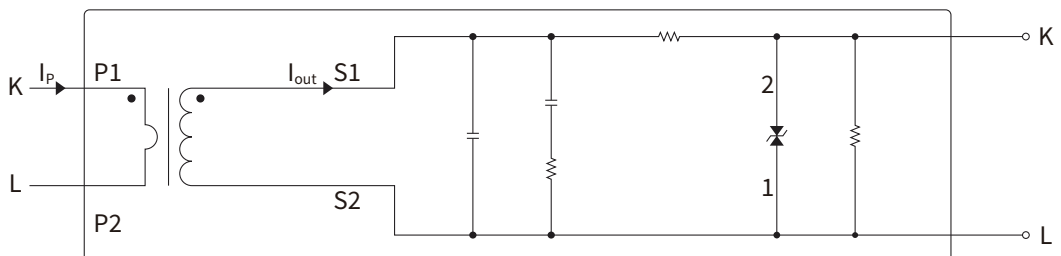

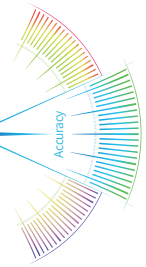

## 2.2 JPS20N-005-333mV

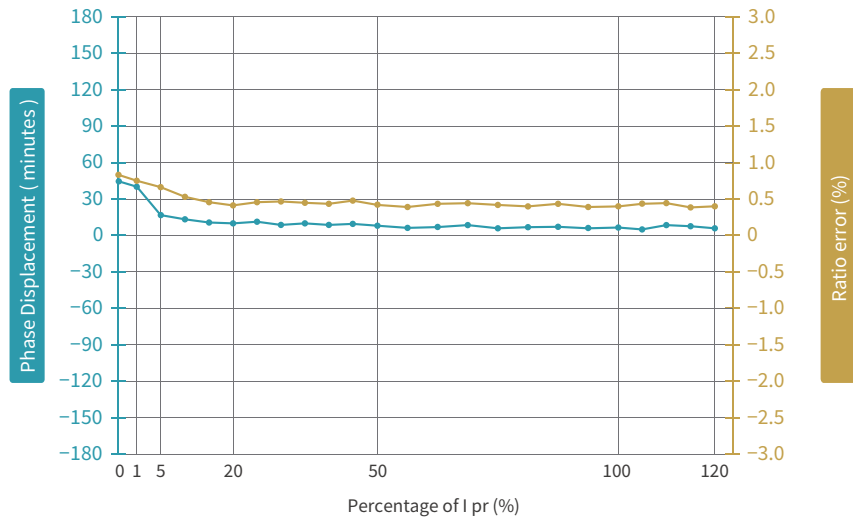

## 2.3 JPS20N-015-333mV

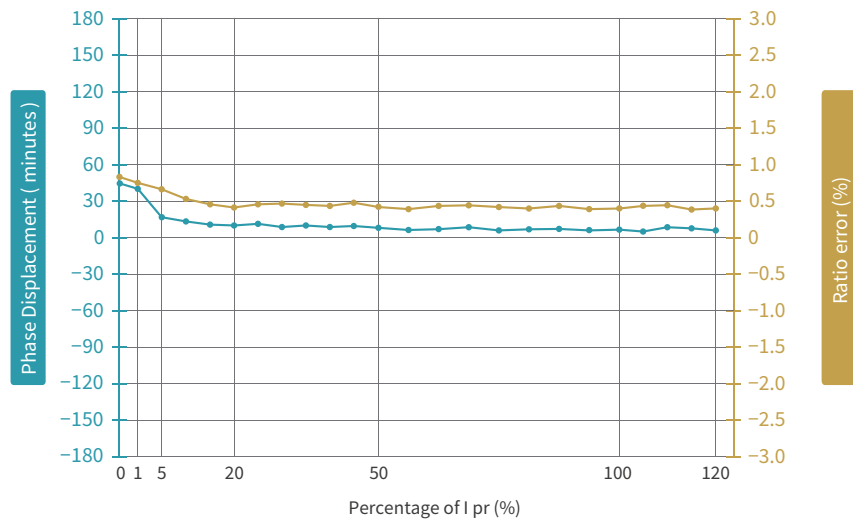

## 2.4 JPS20N-020-333mV

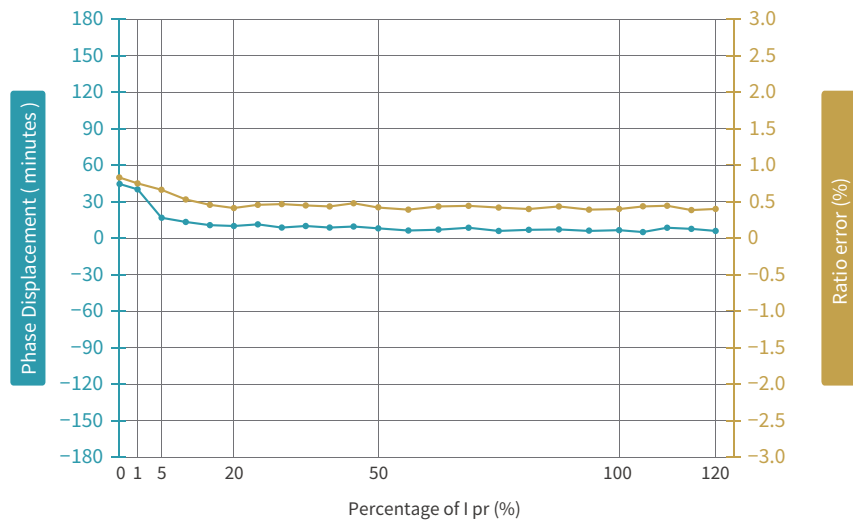

2.5 JPS20N-030-333mV

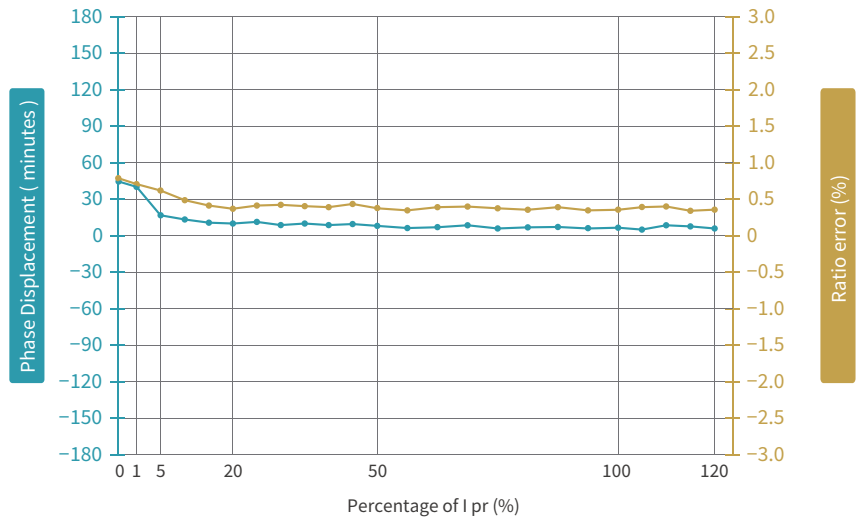

2.6 JPS20N-050-333mV

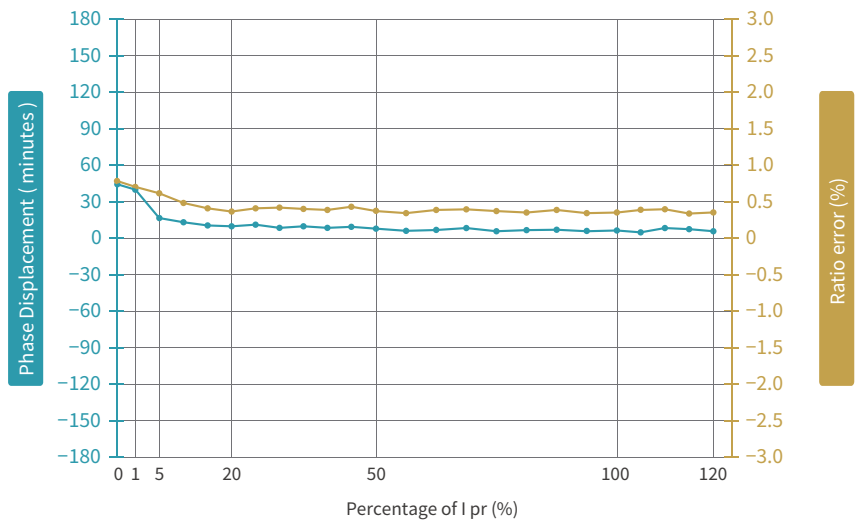

2.7 JPS20N-070-333mV

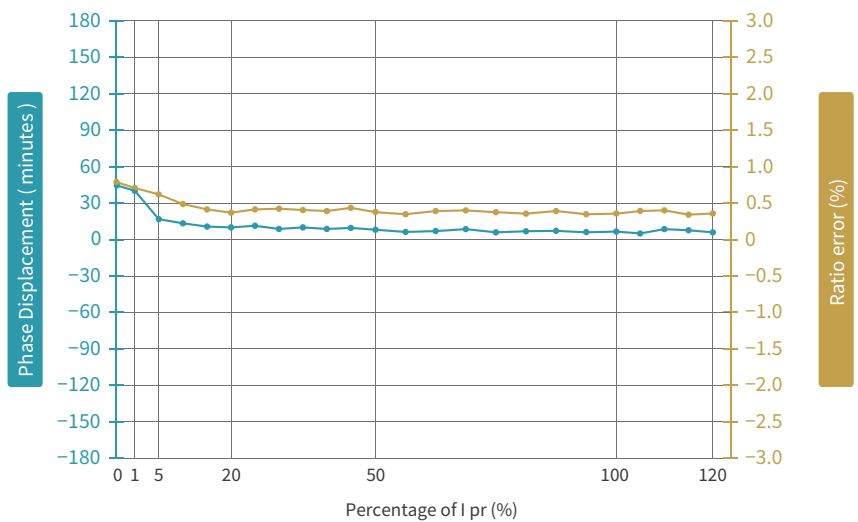

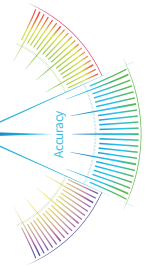

### 2.8 JPS20N-100-333mV

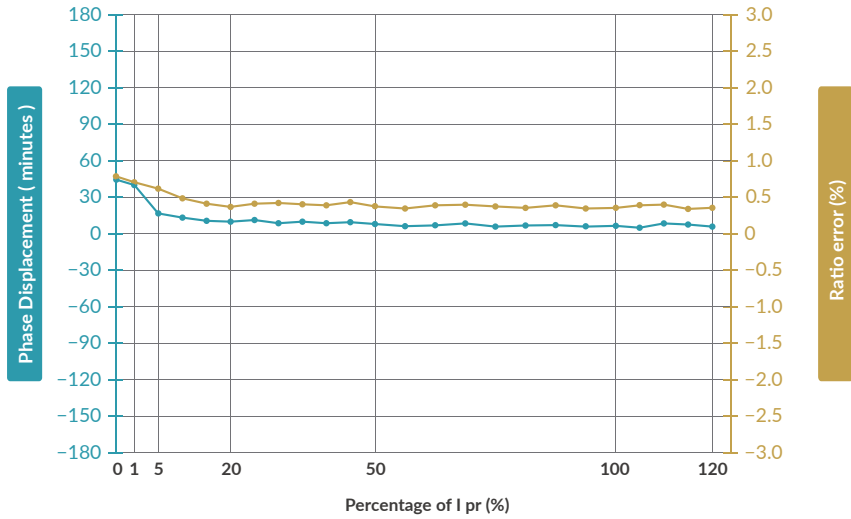

### 2.9 JPS20N-125-333mV

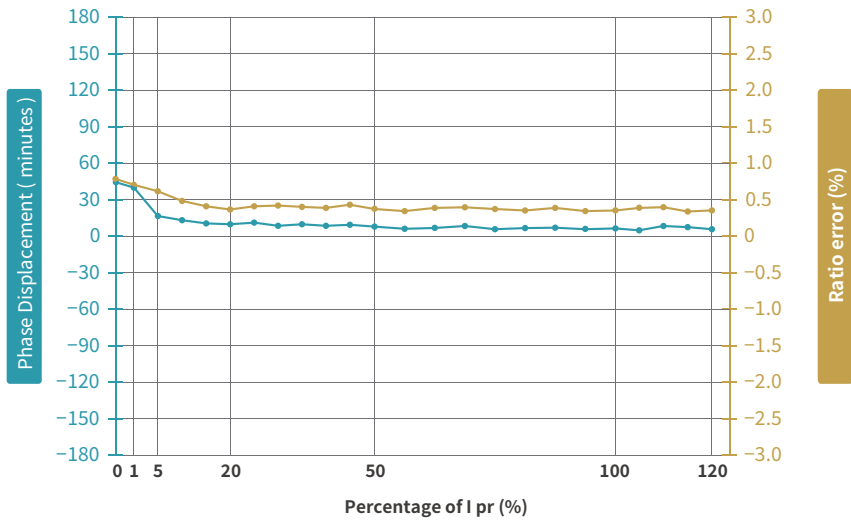

### 2.10 JPS20N-150-333mV

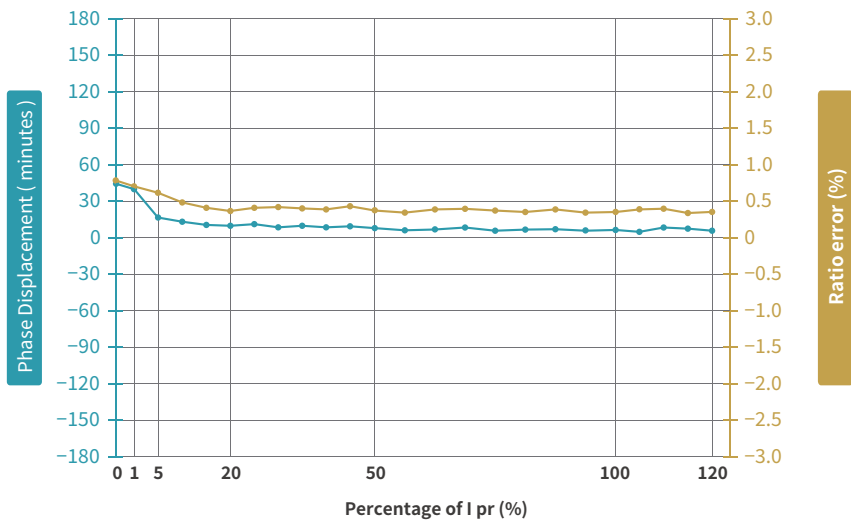

2.11 JPS20N-200-333mV

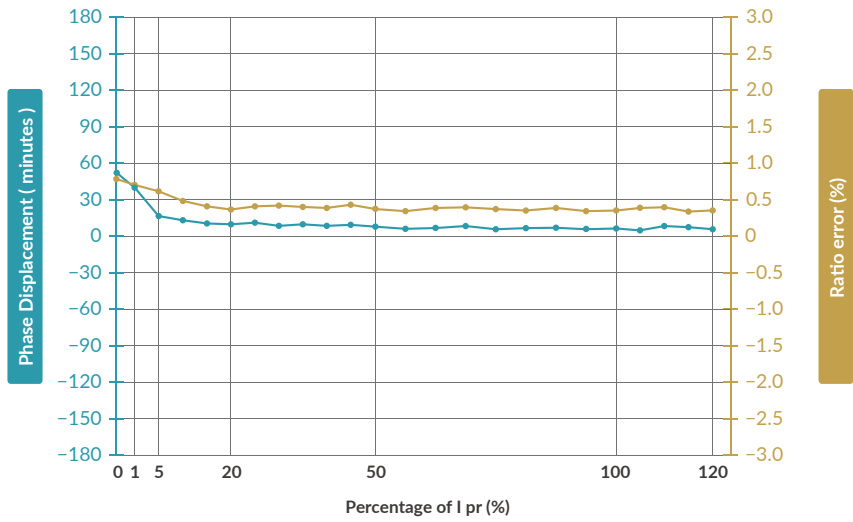

2.12 JPS20N-250-333mV

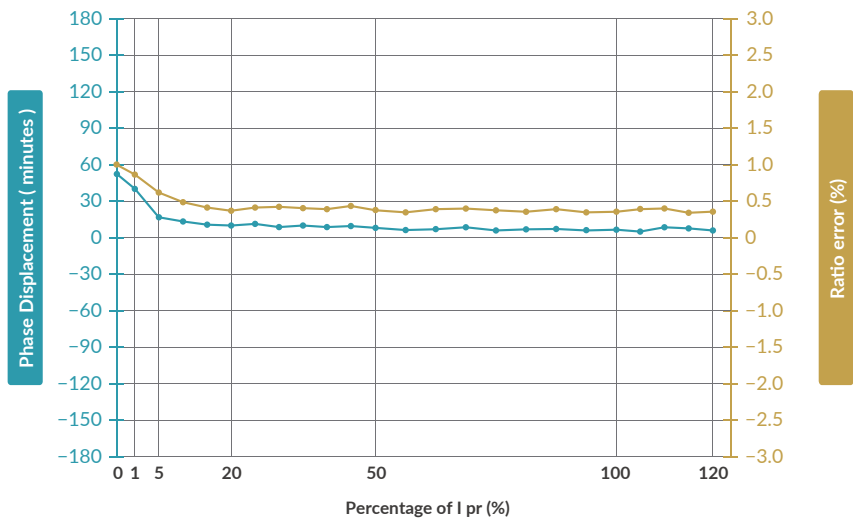

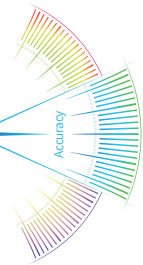

## Current Transformers JPS33N-XXXX-333mV SERIES

The JPS series of split core current transformers is designed for easy and efficient installation, making them ideal for use in both new construction and retrofit applications. The split core design enables quick and simple installation by allowing the CT to be easily opened and placed around the power cable. The JPS series also features enhanced durability, making them resistant to the effects of vibration and shock.

The JPS series of CTs can accurately measure the current flowing through the power line with Revenue grade accuracy. This makes them suitable for use in Power Quality measuring and Revenue Grade metering applications. The unique design of the JPS series is listed under UL 2808 and UL/EN 61010-1, allowing for field installation of the CT in manufactured subpanels and electrical cabinets while maintaining the UL rating and manufacturer warranty.

In addition, the JPS series CTs feature a secure locking mechanism that is noticed by a single click sound. This ensures that the CTs remain firmly in place and do not shift or move, providing accurate and reliable current measurement. Overall, the JPS series of split core current transformers offers a convenient and effective solution for current measurement in a variety of applications.

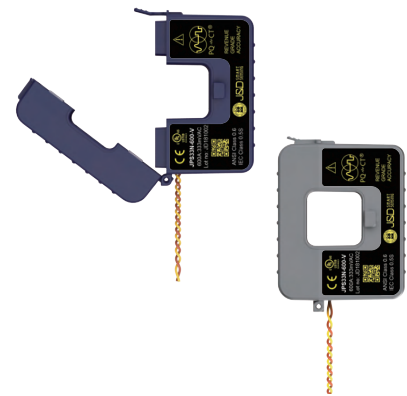

### Advantages

- IEEE/ANSI C57.13, Class 0.3/0.6 accuracy
- IEC 61869-2 Class 0.2S/0.5S accuracy
- Accessories options for installation (Terminal, plug-in, RJ12 port)

### Application

- ANSI C12.20 of class 0.2/0.5
- IEC 62053-22 of class 0.2S/0.5S
- IEC 61000-4-30 A ED3 for Power Quality Meter

### Standards

- UL Listed UL2808 (XOBA) : Pollution Degree: 3 CAT IV, 600 Vac
- UL/EN61010-1(PICQ) : Pollution Degree: 3 CAT IV, 600 Vac

Model	Rated Amps	Output	Accuracy	Internal Burden (Ohms)
JPS33N-250-333mV	250A	333mV	0.2/0.5%	3.36 Ω
JPS33N-300-333mV	300A	333mV	0.2/0.5%	3.36 Ω
JPS33N-400-333mV	400A	333mV	0.2/0.5%	3.36 Ω
JPS33N-500-333mV	500A	333mV	0.2/0.5%	3.36 Ω
JPS33N-600-333mV	600A	333mV	0.2/0.5%	3.36 Ω

### How to Use

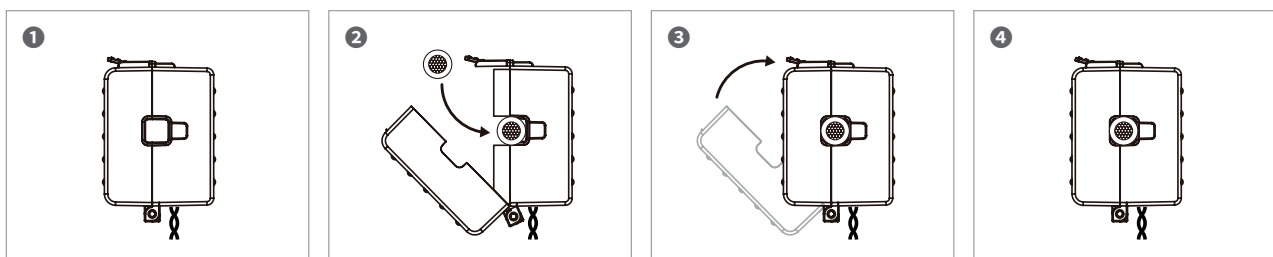

Please refer to "Split-core Current Transformer Installation Guide" for further details.



## 1. Specifications

- Accuracy : Class 0.5S
- System Voltage : 720 V (0.72 kV)
- Overload Withstand : 1.2 times rated current continuously
- Compliant with : IEC/EN 61869-2 & IEEE/ANSI C57.13
- Operating Temperature Range : -40°C to 70°C
- Relative Humidity : 0 to 90% non-condensing
- Test Voltage : 3 kV for 1 minute
- Frequency Range : 50/60 Hz
- Protection Level : 3.0V0-P
- Insulation Category : CAT III 1000 Vac, CAT IV 600 Vac
- Output Lead Wires :  
 Style : Two conductor, brown and yellow twisted pair (equivalent to about one #8 AWG 0.213" dia.), MTW, UL 1015  
 Standard length : 8 ft (2.44m), Gauge : #18 AWG, Voltage : 600Vac

### 1.1 Accuracy

- Ratio Error :  
 Accuracy 0.5% conforms to IEC 61869-2 & IEEE/ANSI C57.13 meets the measuring range from 1% to 120% of  $I_n$
- Phase Angle :  
 50/60 Hz – 0.0 to 2.0 degrees leading from 1% to 120% of rated current

#### Position Sensitivity

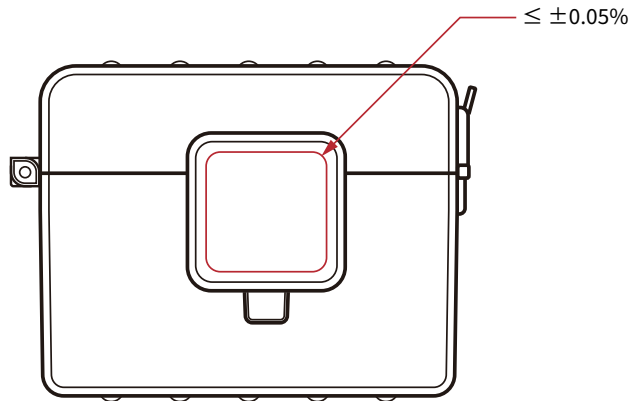

#### Shock and Air Gap Test

- Shock and Vibration Test Report(JPS33)

400A	
Phase error(°)	Linearity Error(%)
0.20	- 0.16
0.22	- 0.15



400A	
Phase error(°)	Linearity Error(%)
0.20	- 0.16
0.21	- 0.17

- Core Air Gap Test Report(JPS33)

400A	
Air gap : 2microns	
Phase error(°)	Linearity Error(%)
0.20	- 0.14



400A	
Air gap : 2.5microns	
Phase error(°)	Linearity Error(%)
0.22	- 0.18

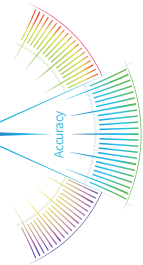

## Harmonic Graphs

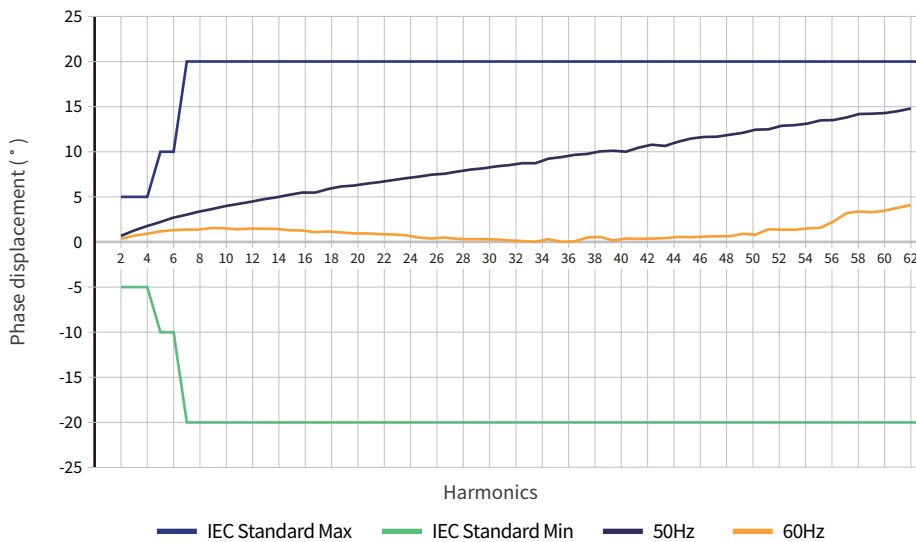
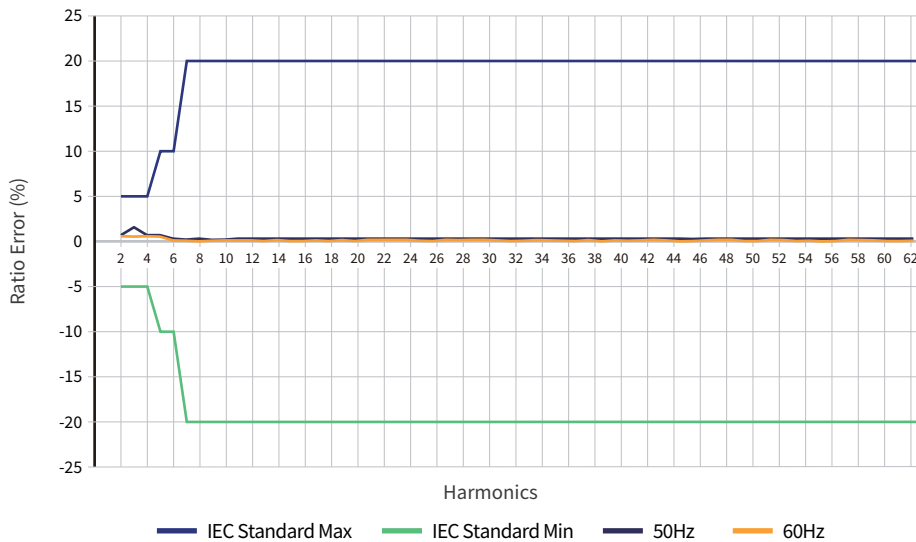

### 1.2 Regulatory

- CE
- UL Listed UL2808 (XOBA) : Pollution Degree: 3 CAT IV, 600 Vac
- UL/EN61010-1(PICQ) : Pollution Degree: 3 CAT IV, 600 Vac
- RoHs Compliant

### 1.3 Environmental

- **Operating Temperature** : -40°C to 70°C (-40°F to +158°F)
- **Operating Humidity** : Non-condensing, 0 to 95% relative humidity(RH)
- **Operating Altitude** : Up to 3000 m (9842 feet)
- **Pollution Degree** : 3 (harsh environment)
- **Indoor Use** : Suitable for indoor use
- **Outdoor Use** : Suitable for outdoor use when mounted in a NEMA 3R or 4 (IP 66) rated enclosure, provided the ambient temperature will not exceed 55°C (131°F)

### 1.4 Mechanical

- Width : 96mm
- Height : 77.5mm
- Thickness : 36mm
- Opening : 33mm
- Weight : 590g
- Core Nickel Core : high permeability ferrite
- Standard lead wire : 2.44m, 18AWG

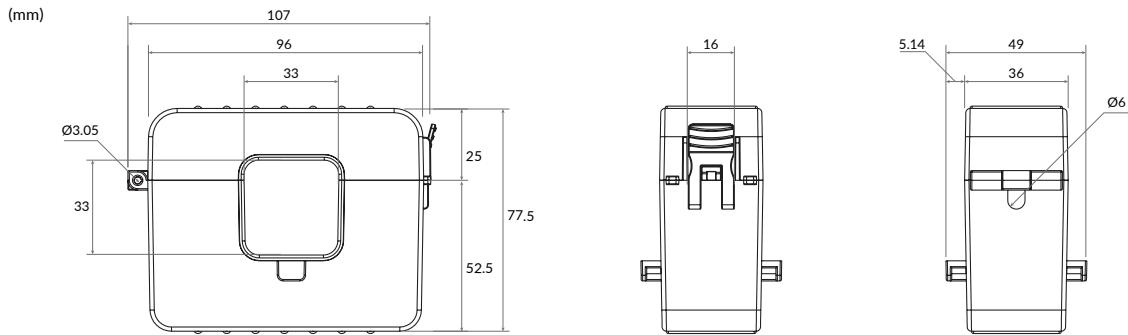

### 1.5 Labels

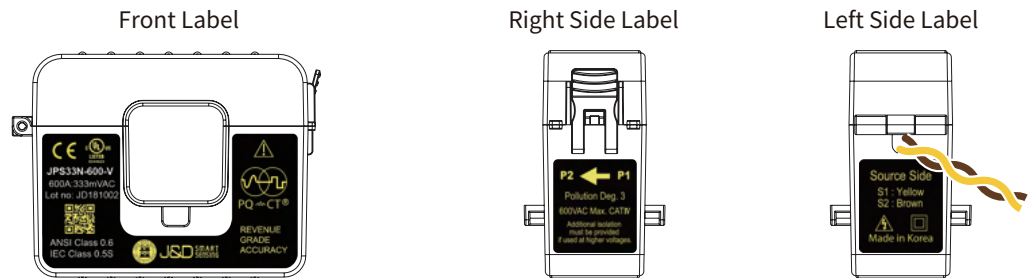

- QR code : <Model> ; <SerialNum> ; Scan QR code for Instruction Manual
- Orientation : Mount the CT referring to the right side label attached(P1->P2).

## 2. Typical Accuracy

- In the following graphs, a positive phase angle error indicates that the output of the CT leads the primary current.
- Graphs show typical performance at 25°C, 60 Hz
- Performance Graphs - The standard CT meets ANSI/IEEE C57.13 class 0.6 standard & IEC 61869-2 standard class 0.5

### 2.1 Schematic Diagram

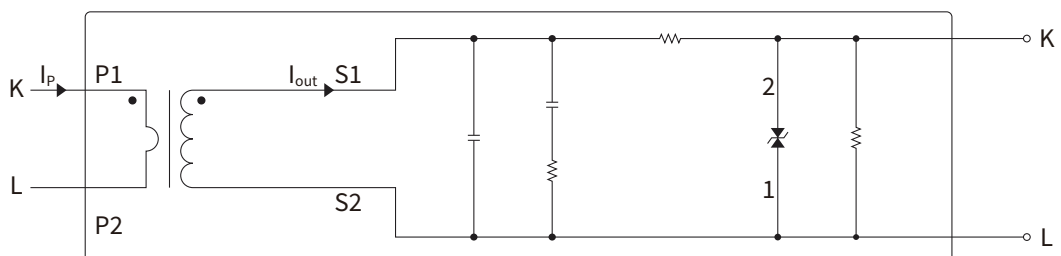

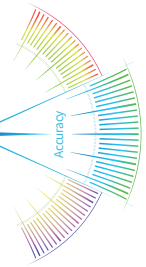

## 2.2 JPS33N-250-333mV

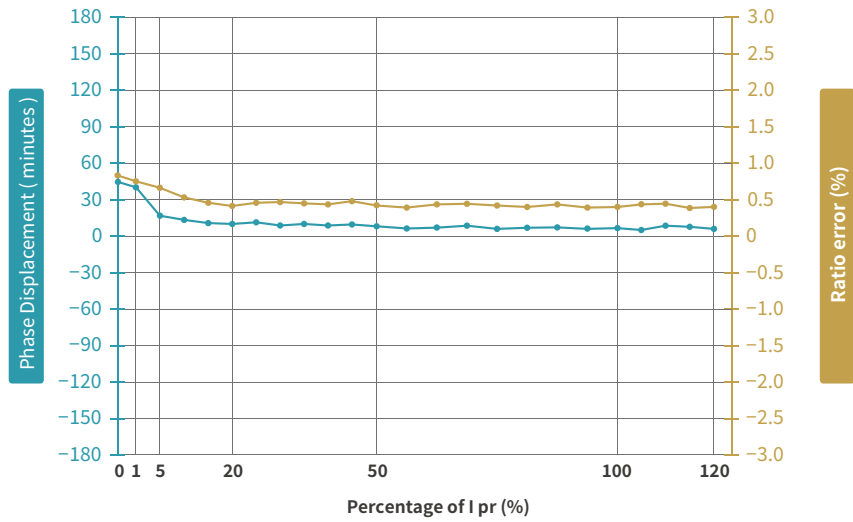

## 2.3 JPS33N-300-333mV

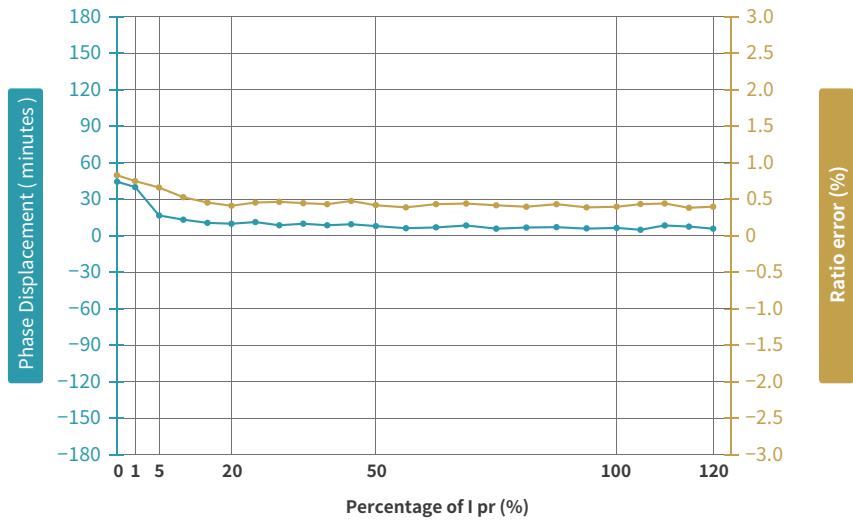

## 2.4 JPS33N-400-333mV

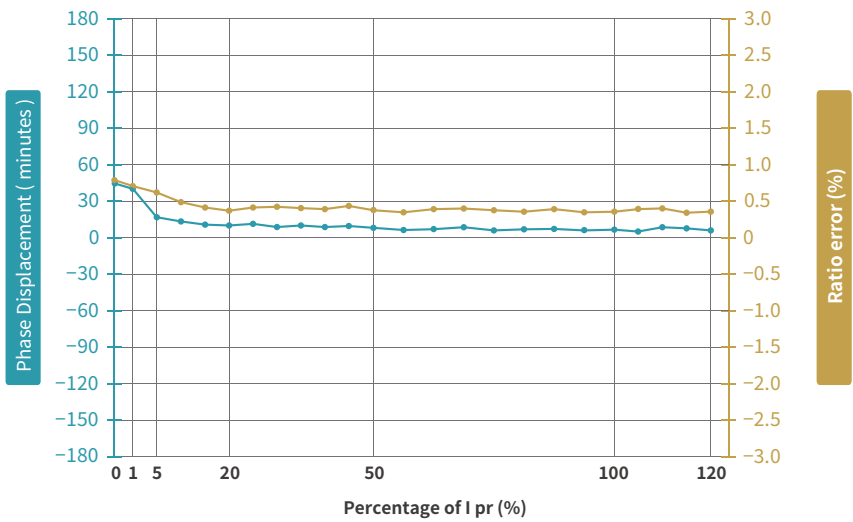

2.5 JPS33N-500-333mV

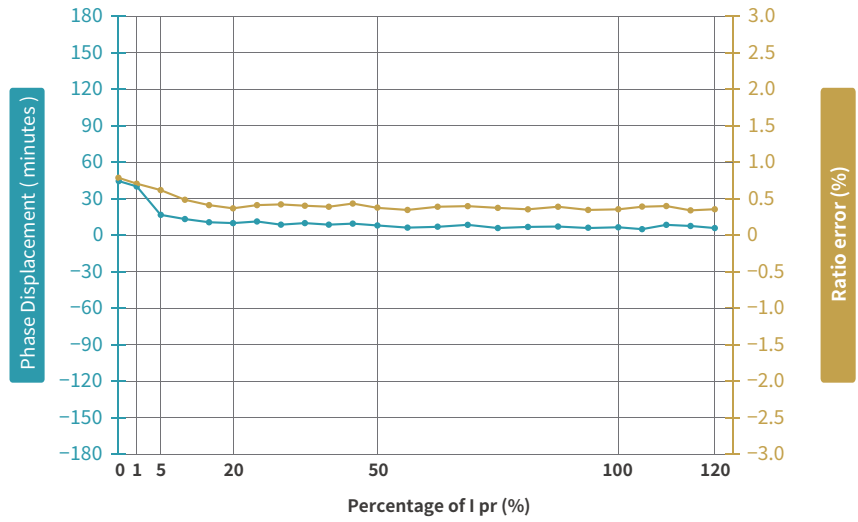

2.6 JPS33N-600-333mV

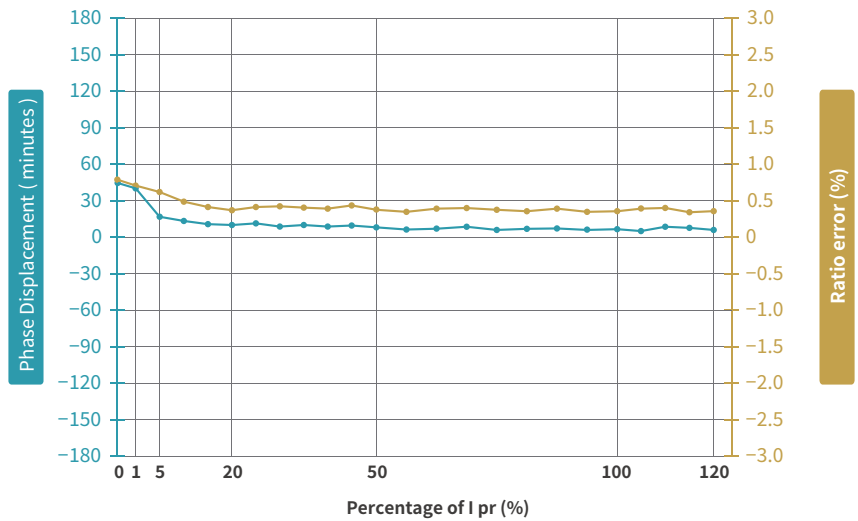

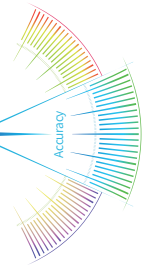

## Current Transformers JPS52N-XXXX-333mV SERIES

The JPS series of split core current transformers is designed for easy and efficient installation, making them ideal for use in both new construction and retrofit applications. The split core design enables quick and simple installation by allowing the CT to be easily opened and placed around the power cable. The JPS series also features enhanced durability, making them resistant to the effects of vibration and shock.

The JPS series of CTs can accurately measure the current flowing through the power line with Revenue grade accuracy. This makes them suitable for use in Power Quality measuring and Revenue Grade metering applications. The unique design of the JPS series is listed under UL 2808 and UL/EN 61010-1, allowing for field installation of the CT in manufactured subpanels and electrical cabinets while maintaining the UL rating and manufacturer warranty.

In addition, the JPS series CTs feature a secure locking mechanism that is noticed by a single click sound. This ensures that the CTs remain firmly in place and do not shift or move, providing accurate and reliable current measurement. Overall, the JPS series of split core current transformers offers a convenient and effective solution for current measurement in a variety of applications.

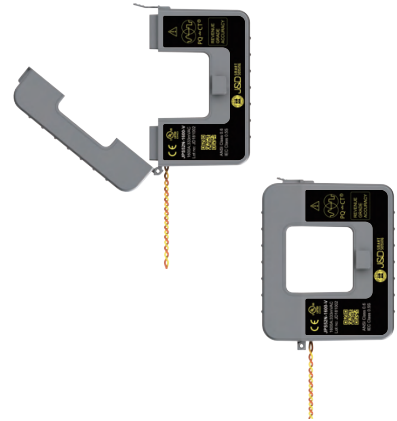

### Advantages

- IEEE/ANSI C57.13, Class 0.3/0.6 accuracy
- IEC 61869-2 Class 0.2S/0.5S accuracy
- Accessories options for installation (Terminal, plug-in, RJ12 port)

### Application

- ANSI C12.20 of class 0.2/0.5
- IEC 62053-22 of class 0.2S/0.5S
- IEC 61000-4-30 A ED3 for Power Quality Meter

### Standards

- UL Listed UL2808 (XOBA) : Pollution Degree: 3 CAT IV, 600 Vac
- UL/EN61010-1(PICQ) : Pollution Degree: 3 CAT IV, 600 Vac

Model	Rated Amps	Output	Accuracy	Internal Burden (Ohms)
JPS52N-400-333mV	400mA	333mV	0.2/0.5%	3.36 Ω
JPS52N-500-333mV	500mA	333mV	0.2/0.5%	3.36 Ω
JPS52N-600-333mV	600mA	333mV	0.2/0.5%	3.36 Ω
JPS52N-800-333mV	800mA	333mV	0.2/0.5%	3.36 Ω
JPS52N-1000-333mV	1000mA	333mV	0.2/0.5%	3.36 Ω
JPS52N-1200-333mV	1200mA	333mV	0.2/0.5%	3.36 Ω
JPS52N-1600-333mV	1600mA	333mV	0.2/0.5%	3.36 Ω

### How to Use

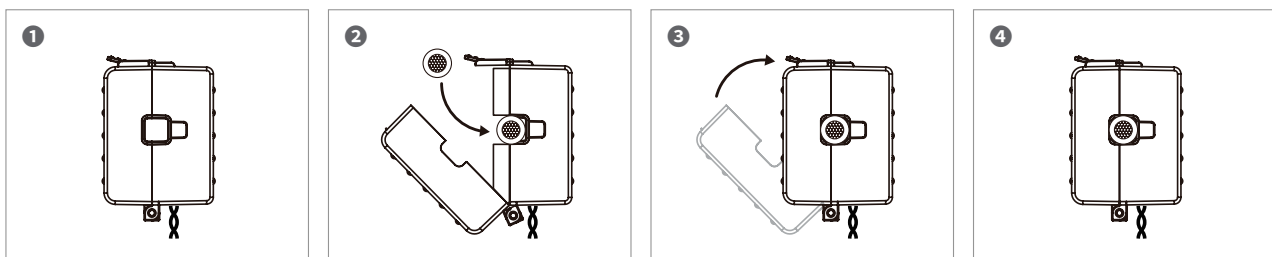

Please refer to "Split-core Current Transformer Installation Guide" for further details.

## 1. Specifications

- Accuracy : Class 0.5S
- System Voltage : 720 V (0.72 kV)
- Overload Withstand : 1.2 times rated current continuously
- Compliant with : IEC/EN 61869-2 & IEEE/ANSI C57.13
- Operating Temperature Range : -40°C to 70°C
- Relative Humidity : 0 to 90% non-condensing
- Test Voltage : 3 kV for 1 minute
- Frequency Range : 50/60 Hz
- Protection Level : 3.0V0-P
- Insulation Category : CAT III 1000 Vac, CAT IV 600 Vac
- Output Lead Wires :  
 Style : Two conductor, brown and yellow twisted pair (equivalent to about one #8 AWG 0.213" dia.), MTW, UL 1015  
 Standard length : 8 ft (2.44m), Gauge : #18 AWG, Voltage : 600Vac

### 1.1 Accuracy

- Ratio Error :  
 Accuracy 0.5% conforms to IEC 61869-2 & IEEE/ANSI C57.13 meets the measuring range from 1% to 120% of  $I_n$
- Phase Angle :  
 50/60 Hz – 0.0 to 2.0 degrees leading from 1% to 120% of rated current

#### Position Sensitivity

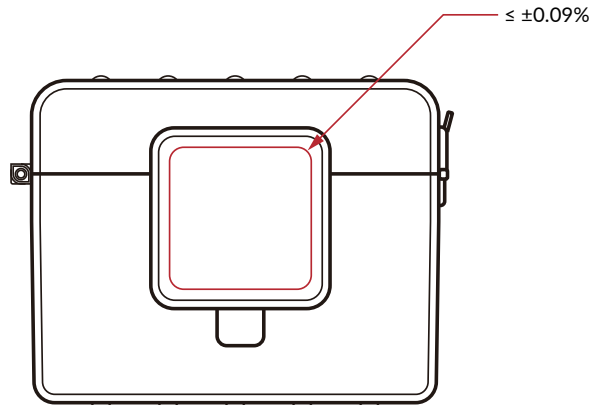

#### Shock and Air Gap Test

- Shock and Vibration Test Report(JPS52)

1000A	
Phase error(°)	Linearity Error(%)
0.22	- 0.16
0.24	- 0.17



1000A	
Phase error(°)	Linearity Error(%)
0.20	- 0.16
0.23	- 0.19

- Core Air Gap Test Report(JPS52)

1000A	
Air gap : 2microns	
Phase error(°)	Linearity Error(%)
0.22	- 0.16



1000A	
Air gap : 2.5microns	
Phase error(°)	Linearity Error(%)
0.22	- 0.18

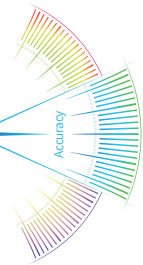

## Harmonic Graphs

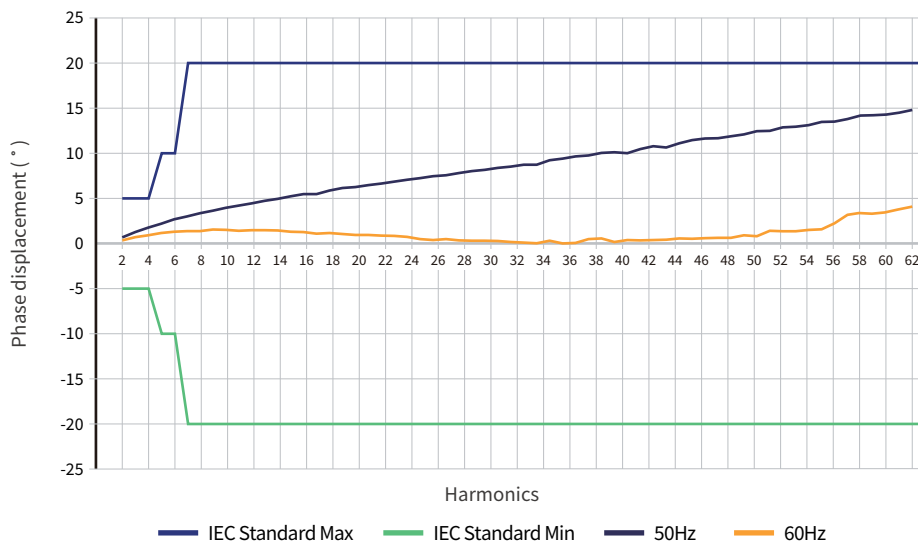
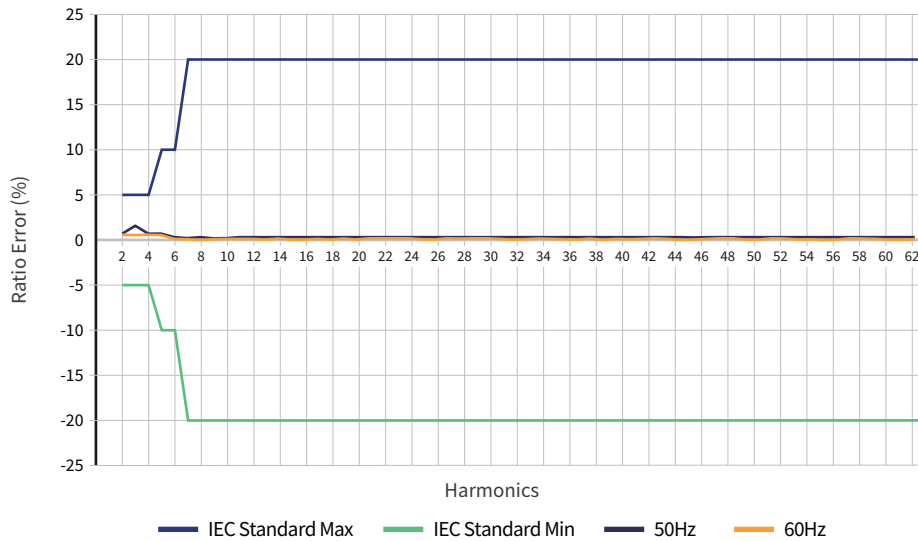

### 1.2 Regulatory

- CE
- UL Listed UL2808 (XOBA) : Pollution Degree: 3 CAT IV, 600 Vac
- UL/EN61010-1(PICQ) : Pollution Degree: 3 CAT IV, 600 Vac
- RoHs Compliant

### 1.3 Environmental

- **Operating Temperature** : -40°C to 70°C (-40°F to +158°F)
- **Operating Humidity** : Non-condensing, 0 to 95% relative humidity(RH)
- **Operating Altitude** : Up to 3000 m (9842 feet)
- **Pollution Degree** : 3 (harsh environment)
- **Indoor Use** : Suitable for indoor use
- **Outdoor Use** : Suitable for outdoor use when mounted in a NEMA 3R or 4 (IP 66) rated enclosure, provided the ambient temperature will not exceed 55°C (131°F)



### 1.4 Mechanical

- Width : 125mm
- Height : 103.5mm
- Thickness : 41mm
- Opening : 52mm
- Weight : 970g
- Core Nickel Core : high permeability ferrite
- Standard lead wire : 2.44m, 18AWG

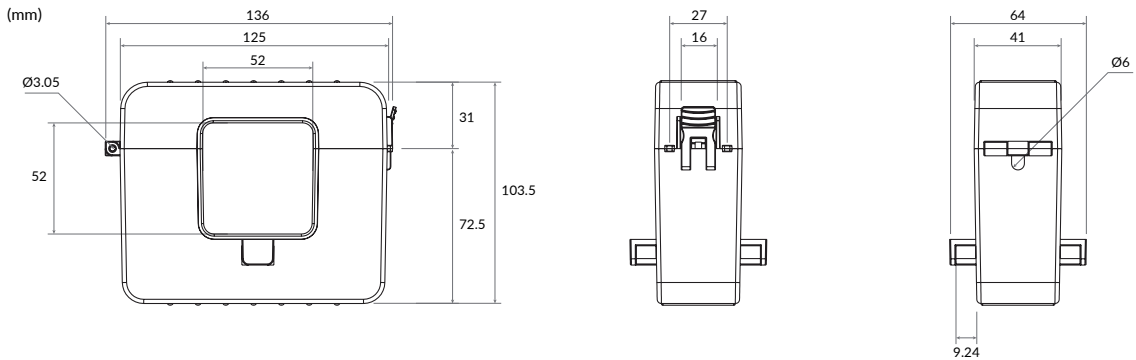

### 1.5 Labels

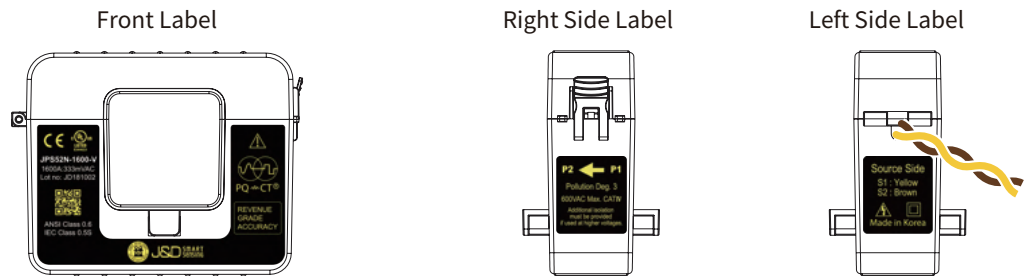

- QR code : <Model> ; <SerialNum> ; Scan QR code for Instruction Manual
- Orientation : Mount the CT referring to the right side label attached(P1->P2).

## 2. Typical Accuracy

- In the following graphs, a positive phase angle error indicates that the output of the CT leads the primary current.
- Graphs show typical performance at 25°C, 60 Hz
- Performance Graphs - The standard CT meets ANSI/IEEE C57.13 class 0.6 standard & IEC 61869-2 standard class 0.5

### 2.1 Schematic Diagram

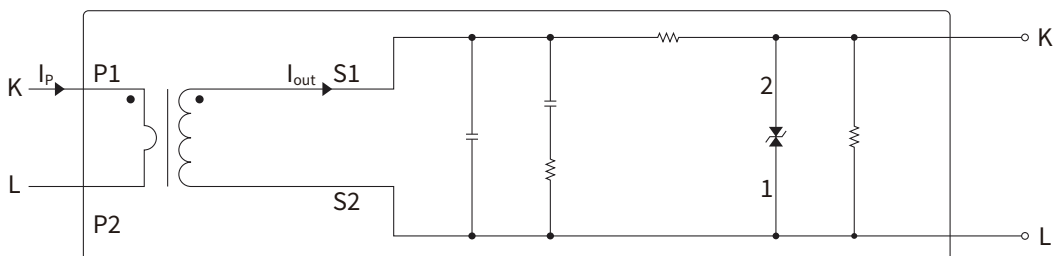

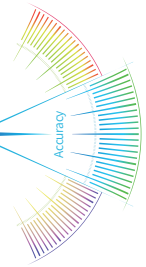

## 2.2 JPS52N-400-333mV

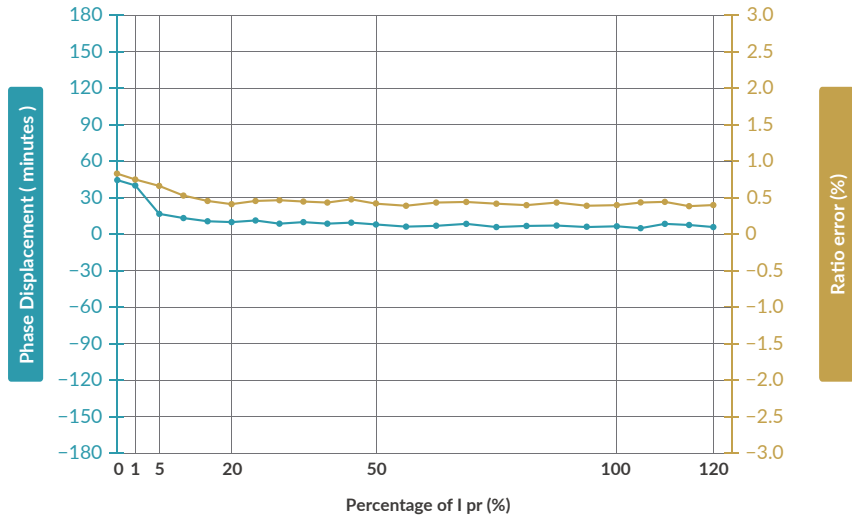

## 2.3 JPS52N-500-333mV

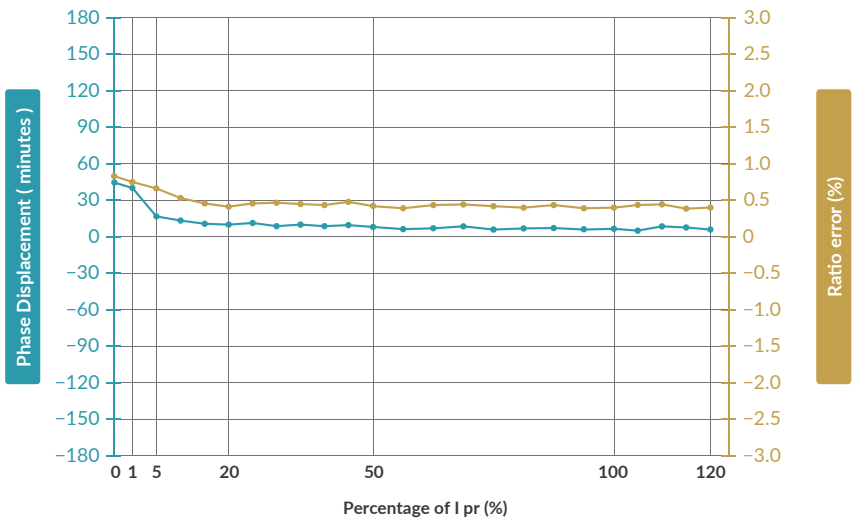

## 2.4 JPS52N-600-333mV

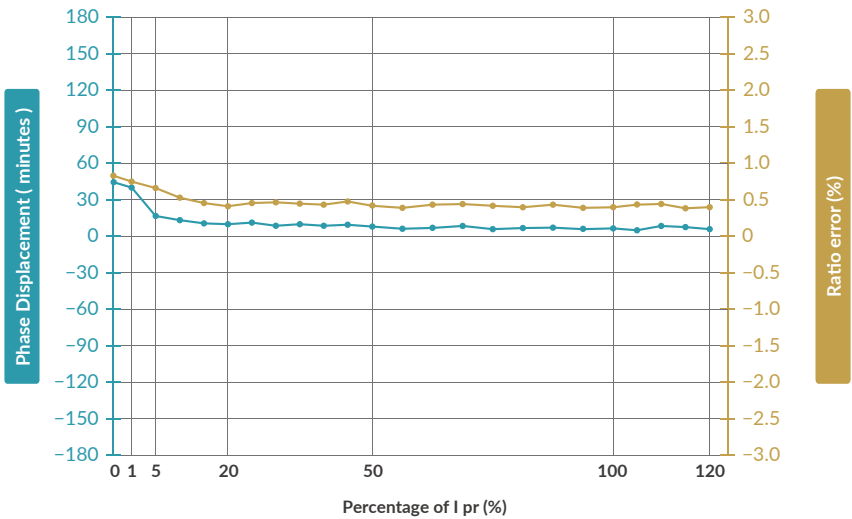

2.5 JPS52N-800-333mV

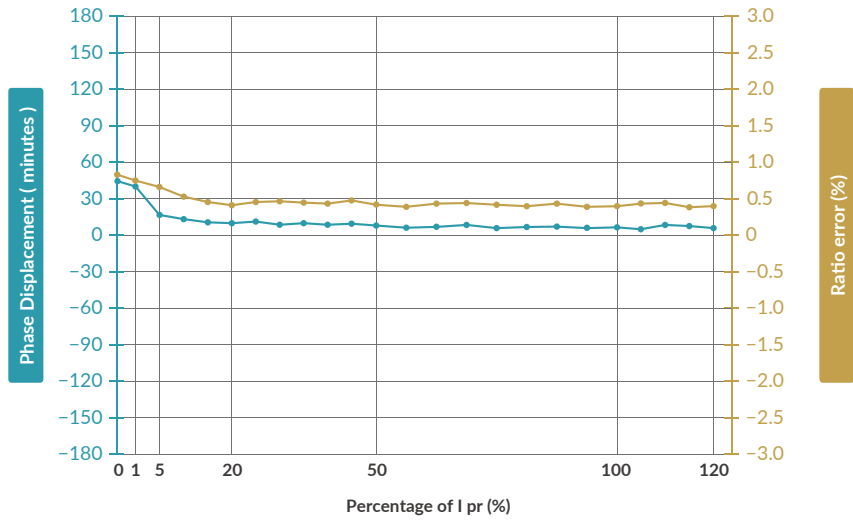

2.6 JPS52N-1000-333mV

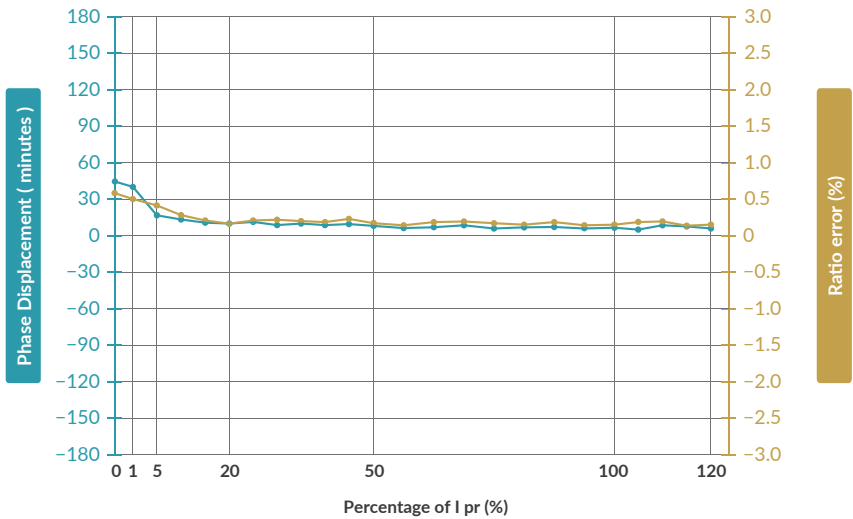

2.7 JPS52N-1200-333mV

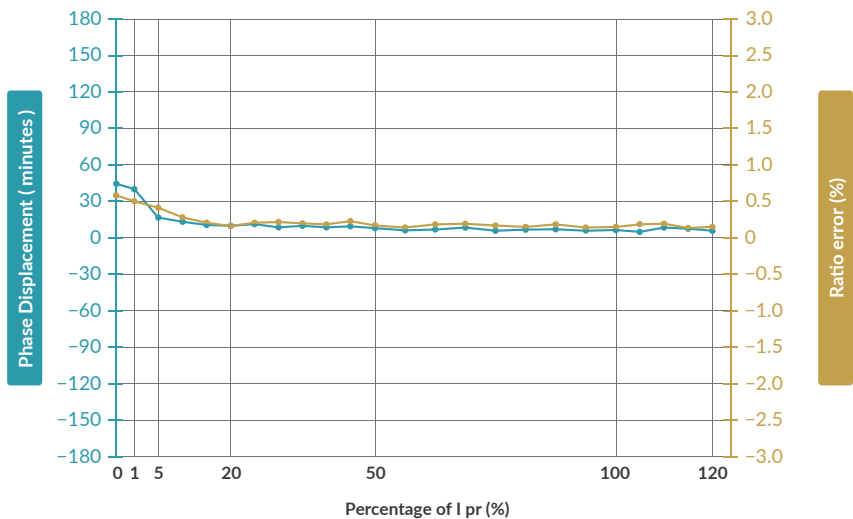

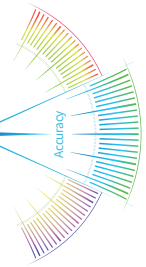

## 2.8 JPS52N-1600-333mV

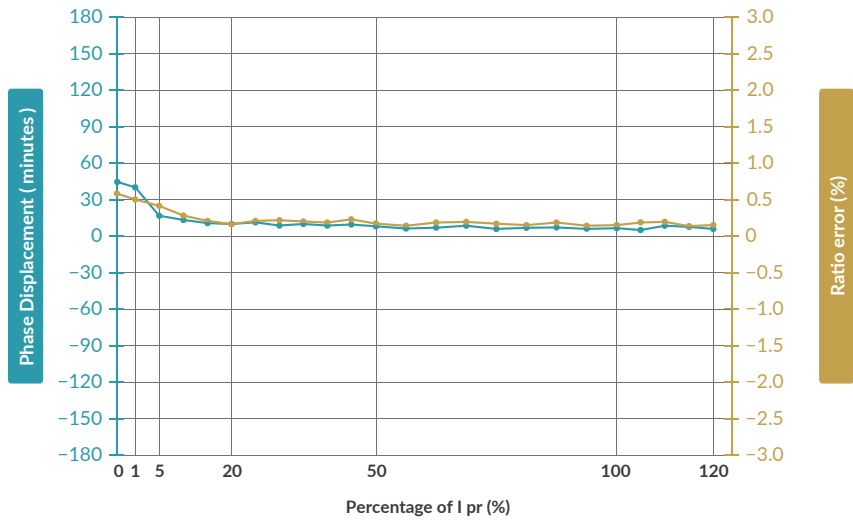

## Safety Guide

### Safety

The J&D CTs are UL2808 Listed, UL/EN 61010-1, CE, RoHS compliant and certified, are also conformed up to Pollution degree 3, 600Vac CAT IV rated devices.



Please be sure that Failure to follow these instructions can result in serious injury and/or cause damage.

The transformer shall be used in electric/electronic equipment in accordance with the operating instructions of all related systems and component manufacturers with respect to applicable standards and safety requirements.

Follow corresponding national regulations and safe electrical work practices.

This equipment must only be installed and serviced by qualified personnel. And the qualified personnel are those who has skills and knowledge related to the construction and operation of this electrical equipment and installations, and has received safety training to recognize and avoid potential hazards.



When operating the transformer, there may be dangerous active voltages (e.g. primary conductor) in certain parts of the module. Users should make sure to take all necessary steps to protect against electric shock. The transformer is a built-in device containing conductive parts that are inaccessible after installation. Therefore, a protective enclosure or additional insulation barrier is necessary.

Safe and trouble-free operation of this converter can only be guaranteed if transport, storage and installation are carried out correctly and operation and maintenance are carried out carefully.

### Remark

- $V_o$  is positive when  $I_p$  flows in the direction of the arrow. (o : output, p : primary current)
- Temperature of the primary conductor should not exceed  $80^{\circ}\text{C}$ ( $176^{\circ}\text{F}$ ).
- Dynamic performances (di/dt and delay time) are the best with a single bar when the primary hole is completely filled.

### Attention

Contact areas (air gap) must be kept clean (particle free) to ensure proper performance

### Warning



This product can expose you to chemicals including Antimony Trioxide, which is known to the State of California to cause cancer. For more information go to: [www.P65Warnings.ca.gov](http://www.P65Warnings.ca.gov)

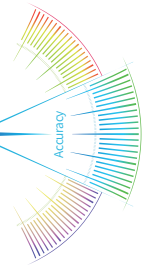

## Installation Guide

The JPSXX-XXXX-x series PQ-CT current transformers measure AC line current in circuits up to 1000 Vac and nominal currents up to 100 amps. They are easy to install with their split-core design. The PQ-CT is ideal for use in High Performance Power Quality Monitoring (IEC 61000-4-30 Class A or S). It may also be used in other power metering applications.

The JPSXX-XXXX-x series may be field-installed inside distribution and control equipment such as switchboards and panelboards, or used in equipment designed for MV / LV substations, power quality meters, energy meters, branch circuit meters, PV monitoring, motor quality diagnostics, traction and data center use, etc.

**DANGER:** Hazardous Voltages Hazard of Electric shock, Explosion, or Arc Flash

### Precautions

- Install in accordance with ANSI/NFPA 70, “National Electrical Code” (NEC). Follow all local electrical codes.
- Only qualified personnel or licensed electricians should install the current transformer (CT). Line voltages of 120 Vac to 1000Vac can be lethal.
- Do not install CTs where they block ventilation openings.
- Do not install CTs in the area of breaker arc venting.
- The current transformer cannot measure direct current (DC), and excessive DC will degrade AC measuring accuracy.
- Electrical codes prohibit installation of CTs in equipment where they exceed 75% of the wiring space of any cross-sectional area.
- The PQ-CT lead wires are considered Class 1 wiring (as defined by the NEC) and must be installed accordingly. They are not suitable for Class 2 wiring methods and should not be connected to Class 2 equipment.
- If the equipment is used in a manner not specified by the manufacturer, the protection provided by the equipment may be impaired.
- Do not install the CT where it may be exposed to: temperatures below -40°C or above 80°C (-40°F to 176°F), excessive moisture, dust, salt spray, or other contamination.
- The PQ-CT may be damaged if dropped or subjected to impact. This can result in reduced accuracy.

### Pre-Installation Checklist

- The CT’s rated current should match or exceed the maximum current of the measured circuit. Ensure that the fuse or circuit breaker’s rating does not exceed the CT’s maximum continuous current rating.
- For highest accuracy, try to separate the CTs installed on different phases by 1.0 inch (25 mm) to minimize magnetic interference.
- It is preferable to install the CT and meter or monitoring device close to each other. However, you may extend the CT wires by 300 feet (100 m) or more by using shielded twisted-pair cabling and by running the CT wires away from high current and line voltage conductors.

### Connecting the Current Transformer

**WARNING:** Make sure that safe and proper working conditions exist prior to installing the CTs. Open/disconnect the circuit from the power distribution system before installing or servicing current transformers to reduce the risk of electric shock.

No special tools are required to install the PQ-CT, JPSXX-XXX-X series. In order to connect the CTs to the meter correctly, follow these steps:

- 1) Find the correct direction of the current flow. P should face the source of current.

Note: If the CT is mounted backwards, the measured power will be negative.

- 2) Make sure all contact surfaces are clean. Debris will increase the magnetic gap, decreasing accuracy. Place the CT around the conductor and close the CT.

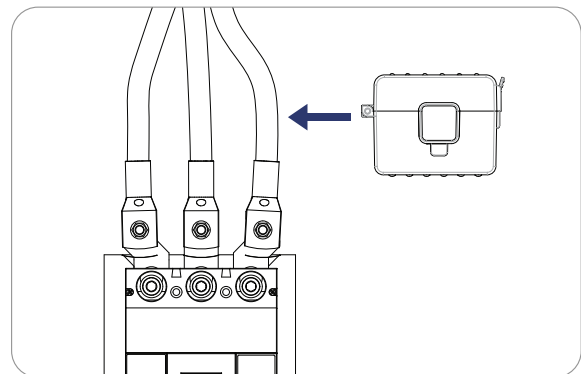

- 3) Use cable ties to ensure the PQ-CT does not move from its position around the conductor.

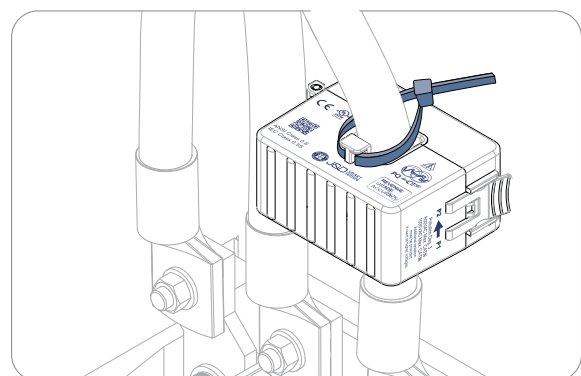

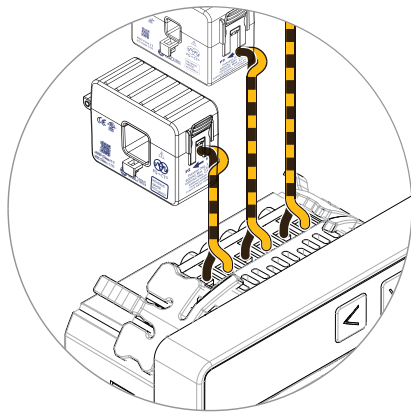

- 4) Connect the secondary leads to the meter. The secondary current from PQ-CT should flow to the meter through S1.
- 5) Close PQ-CT after verifying the installation. You will hear a 'click' if the CT has been closed properly.

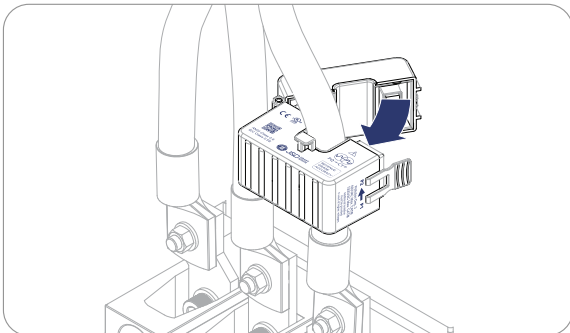
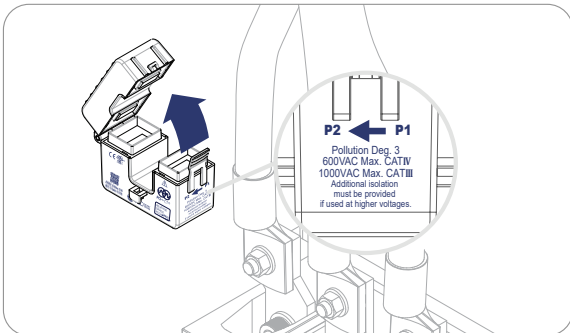

Note : If the white and black wires are reversed, the measured power will be negative. Be careful to match the CT to the voltage phases being measured. Make sure the Ø A CT is measuring the current on the Ø A conductor, and the same for phases B and C. Use colored tape or labels to identify the wires.

Wiring Diagram

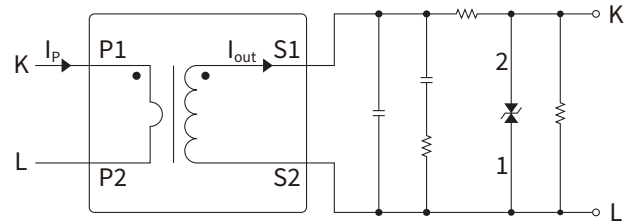

Specifications

JPSxx-xxxx-x		
Model	JPSxx-xxxx-V	JPSxx-xxxx-A
Rated Amps		
JPS10	5, 15, 20, 30, 50, 70, 100	30, 50, 70, 100
JPS20	5, 15, 20, 30, 50, 70, 100, 125, 150, 200, 250	30, 50, 70, 100, 125, 150, 200, 250
JPS33	250, 300, 400, 500, 600	250, 300, 400, 500, 600
JPS52	400, 500, 600, 800, 1000, 1200, 1600	400, 500, 600, 800, 1000, 1200, 1600
Input current	AC current, sine wave, 50/60Hz (specify)	
Output voltage	100, 250, 333, 500, 1000mVac	-
Output current	-	40, 50, 80, 100mVac

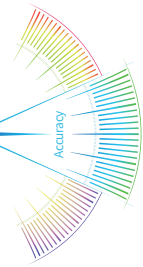

- Insulation Category:  
CAT IV (service entrance): 600 Vac per IEC 61010-1  
CAT III: 1000 Vac per IEC 61010-1
- Standard Accuracy (% of reading)  
IEC Accuracy Class: IEC 61869-2 Class 0.2S or 0.5S  
US Accuracy Class: IEEE/ANSI C57.13, Class 0.3 or 0.6
- Standard Lead Length  
: 8 ft (2.4m) 18 AWG (Shielded cable option available)
- Bandwidth: 40Hz to 400Hz standard
- Operating Temperature: -40°C to 80°C
- Altitude: Up to 3000 meters, Pollution Degree 3, Humidity up to 95% (non-condensing)
- Construction: Molded cases 120°C UL recognized plastic



## Certificate of Calibration



### J&D Electronics

-  Dosim Knowledge Industry CTR B-401, Deokso-ro 234, Wabu-eup, Namyangju-si, Gyeonggi-do, South Korea, (ZIP Code 1275)
-  +82-31-577-2280
-  <https://hqsensing.com>



## Current Transformer

Model: JPS10N-100-100mA  
 Serial Number: Sample  
 Rated Primary Current: 100 A

Manufacture Date: 2022-Nov-10  
 Calibration Date: 2022-Nov-21  
 Calibration Due Date: 2038-Nov-21  
(sixteen year recommended calibration interval)

### Traceable Test Equipment

Traceability is to national Standards administered by U.S NIST and/or Euromet members (U.K. NPL, etc.).

Equipment	Manuf.	Model	Cal Date	Serial Number
CT-Analyzer	Omicron	CT-Analyzer	2022-Nov-21	JC270D

### Asset

I <sub>pn</sub>	I <sub>sn</sub>	Rated burden	Operating burden	Standard	Application	Class	Frequency	R <sub>ct</sub> max
100.0A	0.1A	0.05 VA/1.00	0.05 VA/1.00	IEC 61869-2	Metering	0.5S	60.0Hz	24.323Ω

### Secondary winding resistance

R-meas (25.0°C)	R-ref (75.0°C)	R-meas (25.0°C)+Rlead	R-ref (75.0°C)+Rlead
20.393Ω	24.323Ω	20.393Ω	24.323Ω

### Ratio

		Results at rated burden (0.05 VA)		Results at operating burden (0.05 VA)	
Turns ratio	999.0025	Ratio	100.0 : 0.0999	Ratio	100.0 : 0.0999
ε <sub>t</sub>	-0.0998%	ε	-0.0678%	ε	-0.0678%
Polarity	OK	Δφ	21.62 min	Δφ	21.62 min
		ε <sub>c</sub>	0.6322%	ε <sub>c</sub>	0.6322%



Current ratio error in % at % of rated current at rated burden (0.05 VA)

VA/cos φ	1.00%	5.00%	10.00%	20.00%	50.00%	100.00%	120.00%	200.00%
0.05/1	-0.0676	-0.0700	-0.0733	-0.0710	-0.0682	-0.0678	-0.0676	-0.0739
0.025/1	-0.0502	-0.0525	-0.0556	-0.0544	-0.0516	-0.0512	-0.0511	-0.0551
0.0125/1	-0.0415	-0.0439	-0.0468	-0.0462	-0.0434	-0.0430	-0.0428	-0.0457
0.00625/1	-0.0372	-0.0396	-0.0424	-0.0420	-0.0393	-0.0389	-0.0387	-0.0411

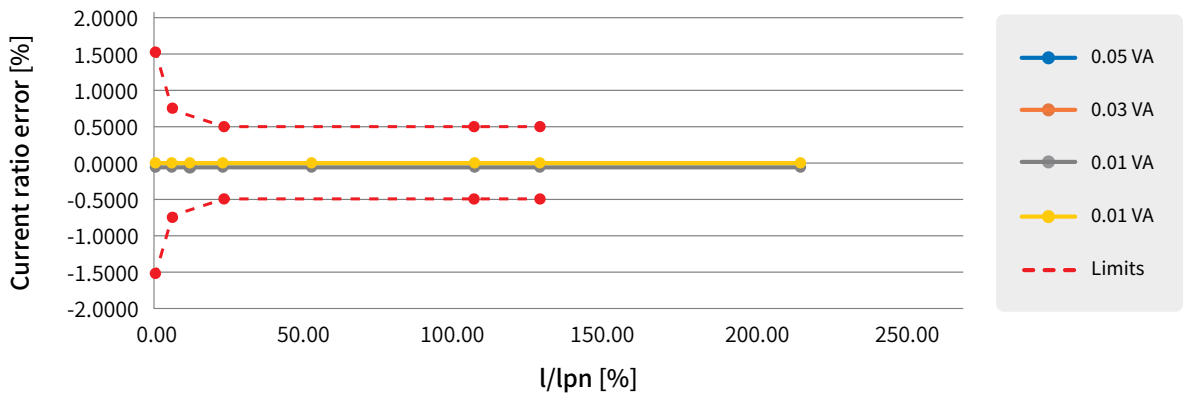

Phase in min at % of rated current at rated burden (0.05 VA)

VA/cos φ	1.00%	5.00%	10.00%	20.00%	50.00%	100.00%	120.00%	200.00%
0.05/1	25.1966	24.4030	23.9913	23.2821	22.2533	21.6164	21.4885	21.5573
0.025/1	22.6142	22.0654	21.6927	21.0962	20.1616	19.5568	19.4417	19.4083
0.0125/1	21.3273	20.8934	20.5371	19.9988	19.1115	18.5238	18.4152	18.3342
0.00625/1	20.6850	20.3066	19.9586	19.4488	18.5853	18.0066	17.9011	17.7973

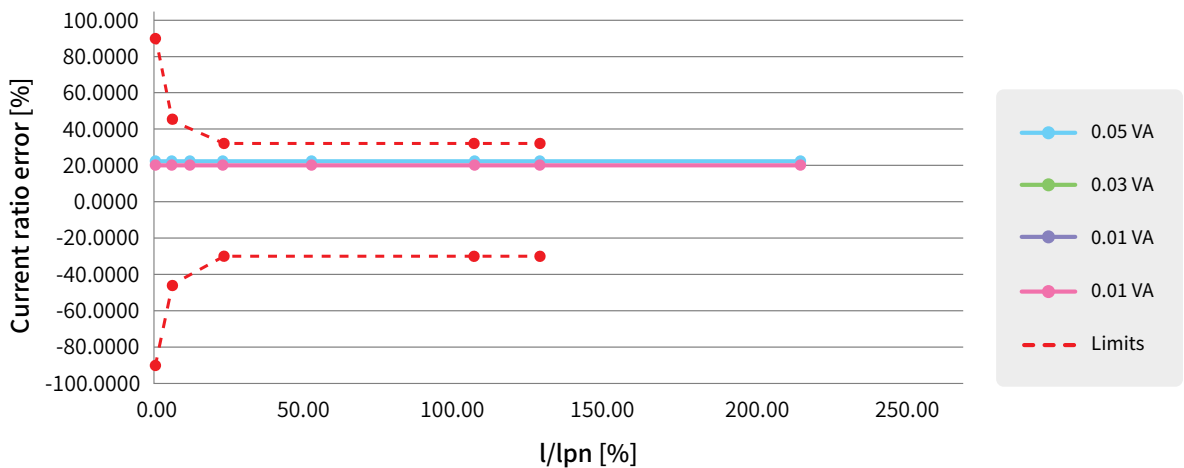



300, Wiryegwangjang-ro, Sujeong-gu, Seongnam-si,  
Gyeonggi-do, South Korea  
<http://www.hqsensing.com>