

## ARCT-XXX-M-ID SERIES

The ARCT-M-ID series features Rogowski coil split-core current transformers designed for the electronic measurement of AC waveform currents, ensuring galvanic isolation between primary and secondary circuits. Specifically tailored for SENSWAY IoT meters with embedded CTid, these transformers undergo rigorous testing for ratio error and phase shift, meeting the accuracy standards of IEC 61869-2 Class 1.0 and IEEE/ANSI C57.13 Class 1.2.

The ARCT-M-ID Series is a large, flexible sensor ideal for monitoring currents akin to split-core CTs. It is particularly suitable for busbar and substantial switchgear applications where standard split-core CTs aren't fitting. While Rogowski coil CTs offer flexibility and ease of installation, they demand a minimum current of approximately 30A to maintain accuracy.

The CTid ARCT-M-ID Series is analogous to the standard Rogowski coil CT but showcases a distinct connector style, incorporates a CTid for automated detection, and comes equipped with an onboard LED. This LED becomes invaluable in identifying the CT connected to a specific sensor port, especially when the CT lead is untraceable from the meter to the conductor in question.



### Key Features

- Current range: 10A up to 5000Amps (We can respond according to other current customer requests)
- CTid Enabled
- Frequency Range: 50/60Hz
- Operating Temperature: -20 °C to 70 °C
- Overvoltage Category: 1000V CAT III, 600V CAT IV
- Positional: Error Better than 2.5%
- Linearity: Better than 1%
- Material: PVC rubber; flame retardant UL 94 V-0 rated
- UL61010-1, EN61010-1 certified



Model	Output(50Hz)	Output(60Hz)	One Loop Accuracy	Two Loop Accuracy
ARCT-080-M-ID	100 mVac	120 mVac	1	X
ARCT-115-M-ID	100 mVac	120 mVac	1	X
ARCT-180-M-ID	100 mVac	120 mVac	1	0.5S
ARCT-300-M-ID	100 mVac	120 mVac	1	0.5S

### How to Use



Option: Busbar mounting



Please refer to "Rogowski coil Current Transformer Installation Guide" for further details.

### 1. Specifications

- **Coil length** : 11.81 inches(30 cm) up to 118.11 inches(300 cm)
- **Window size** : 3.15 inches(80 mm) up to 11.81 inches(300 mm)  
(ex, ARCT-080-M-ID, 080: 80mm, 115: 115mm, 180: 180mm, 300: 300mm)
- **Cord diameter** : 0.31 inches(8 ± 0.2 mm)
- **Weight** : 150 - 500 g
- **Output level (RMS)** : 100 mV / kA @ 50 Hz, 120 mV / kA @ 60 Hz
- **Positioning error** : One loop → < 0.8% of reading  
Two loop → < 0.25% of reading

- Frequency : 40 Hz - 5 kHz
- Overvoltage category : CAT III1000 Vrms(Non-service Entrance), CAT IV 600 Vrms(Non-Service Entrance)
- Pollution degree : 2, Controlled Environment
- Insulation test voltage : 7400 Vrms / 1 min
- Connection cable : 2 x AWG24 [option AWG18] shielded, standard length 1.5m (option 2m -15m)
- Protection degree : IP67(Optional)
- Altitude : up to 2000 m over sea-level
- Operating temperature : -20 °C to +70 °C(-4 °F to +158 °F)
- Storage temperature : -40 °C to +90 °C(-40 °F to +194 °F)
- Relative humidity tolerance : 0 to +85%
- Installation and use : Controlled environment, Indoor

## 2. Output Accuracy

- Ratio Error :  
Accuracy 0.5% conforms to IEC 61869-2 & IEEE/ANSI C57.13 meets the measuring range from 5% to 120% of rated current
- Phase Angle :  
50/60 Hz – 0.0 to 0.5 degrees leading from 5% to 120% of rated current

## 3. Dimensions

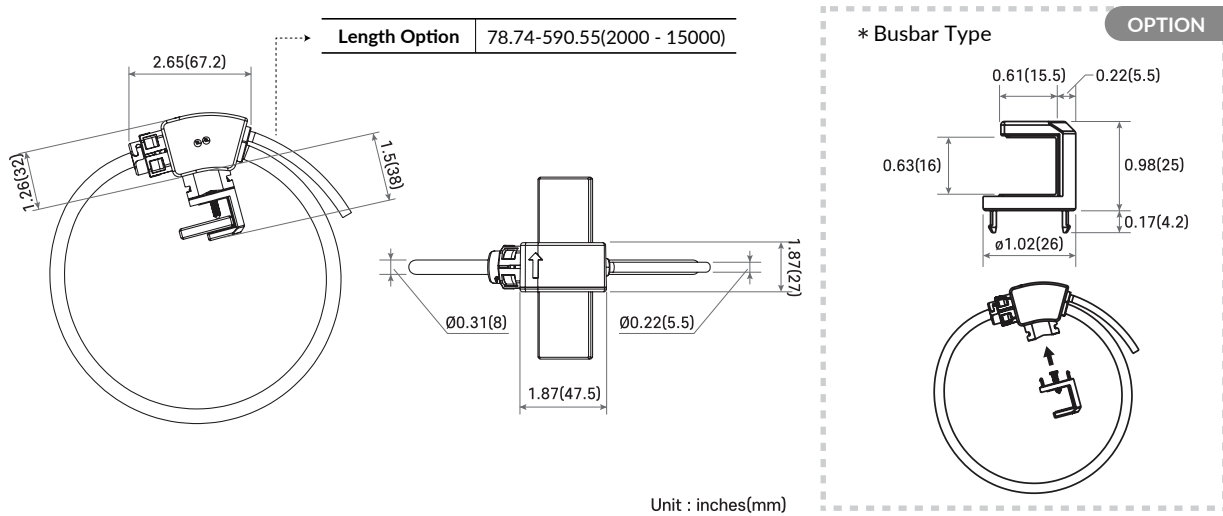

### Connection

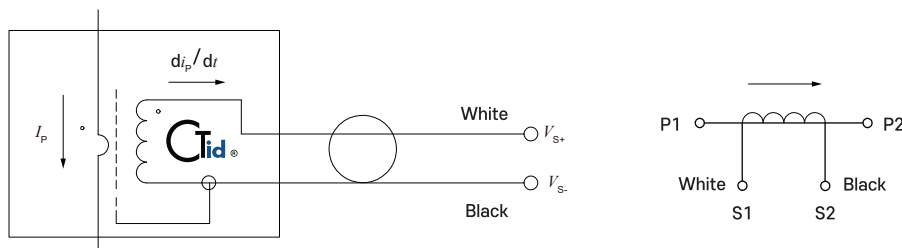

Connection

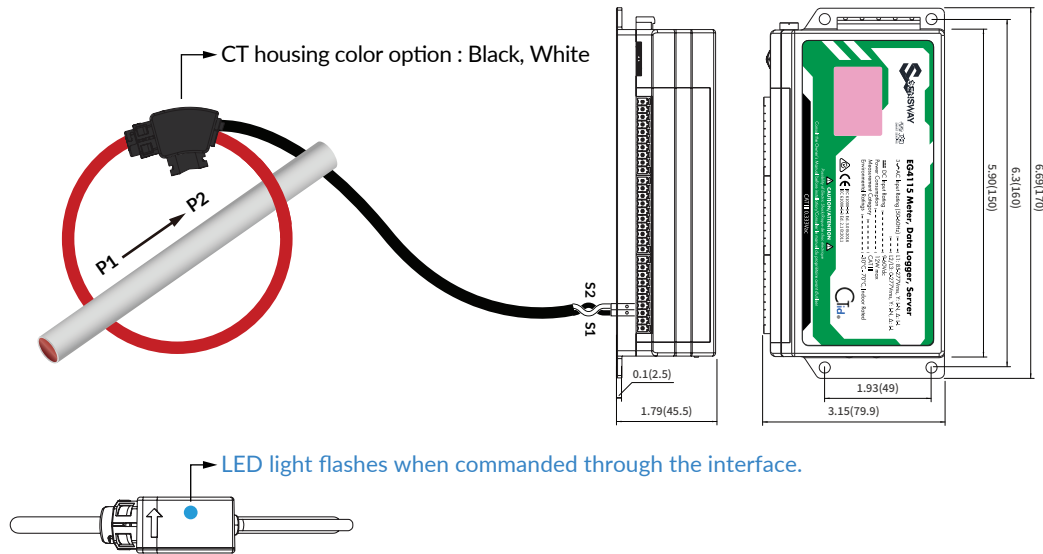

4. Typical Accuracy

- In the following graphs, a positive phase angle error indicates that the output of the Rogowski coil CT with an integrator leads the primary current.
- Graphs show typical performance at 25°C, 50/60Hz
- Performance Graphs - The standard CT meets IEEE C57.13 class 0.6 standard & IEC 61869-2 class 0.5S standard

4.1 ARCT-080-M-ID Series  
Rated current: 500A/120mV(60Hz)

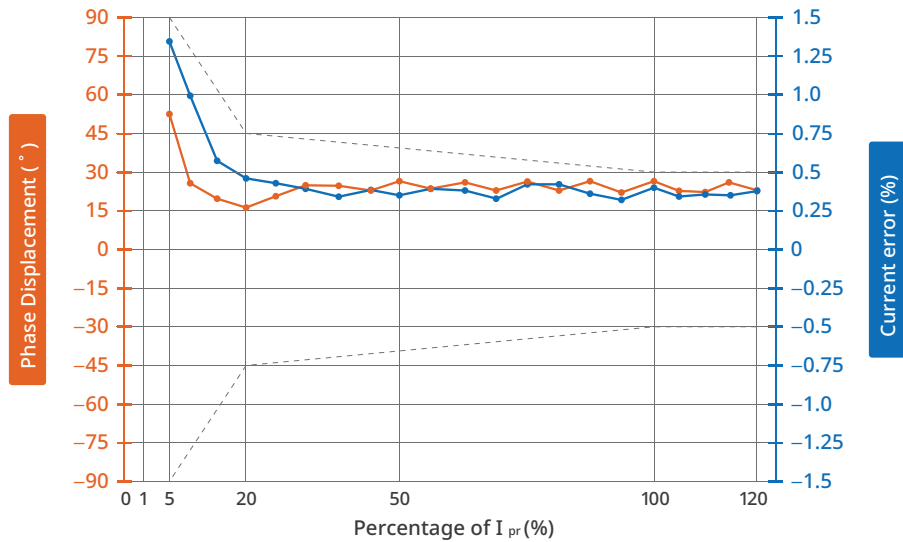

Only meets IEC 61869-2 Class 1.0 at rated currents greater than 500 A.

**4.2 ARCT-115-M-ID Series**  
**Rated current: 1000A/120mV(60Hz)**

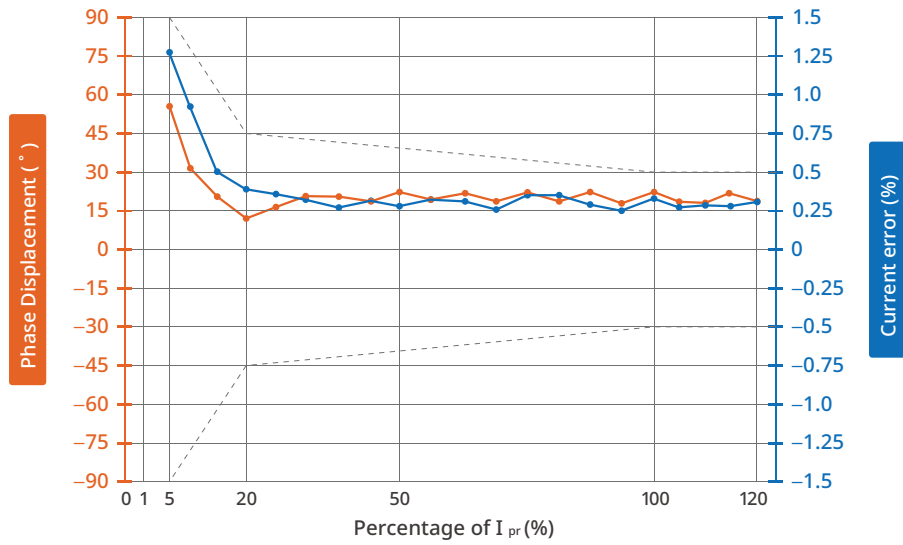

Only meets IEC 61869-2 Class 1.0 at rated currents greater than 1000 A.

**4.3 ARCT-180-M-ID Series**  
**two-loop [Rated current: 2000A/120mV(60Hz)]**

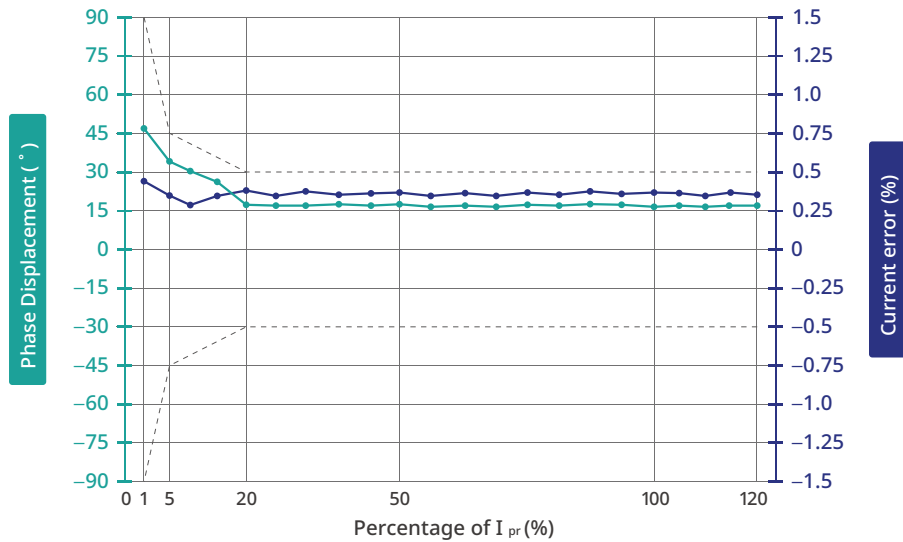

Only meets IEC 61869-2 Class 0.5S at rated currents greater than 2000 A.

#### 4.4 ARCT-300-M-ID Series two-loop [Rated current: 3000A/120mV(60Hz)]

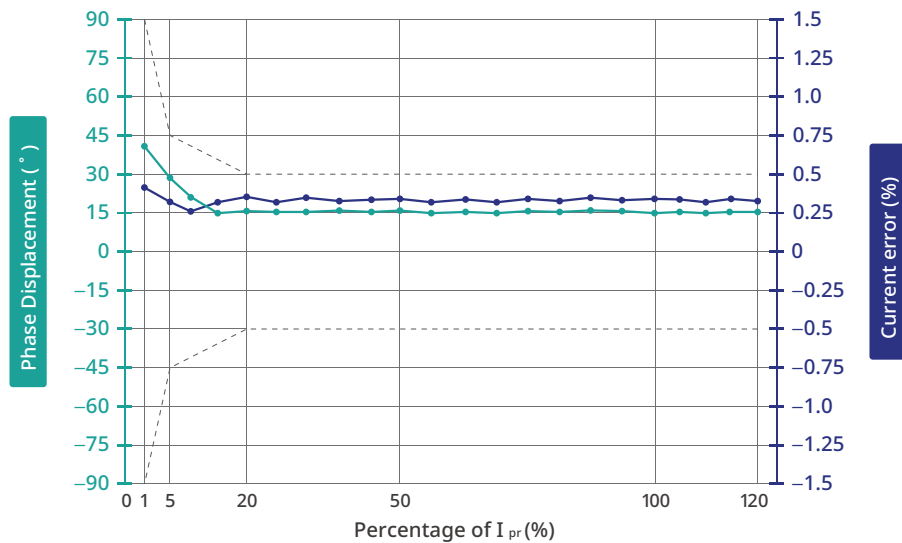

Only meets IEC 61869-2 Class 0.5S at rated currents greater than 3000 A.

## 5. Safety

The J&D CTs are UL/EN 61010-1, CE, RoHS compliant and certified, are also conformed up to Pollution degree 2, 1000Vac CAT III, 600V CAT IV rated devices.



Please be sure that Failure to follow these instructions can result in serious injury and/or cause damage.

The Rogowski coil current transducer shall be used in electric/electronic equipment in accordance with the operating instructions of all related systems and component manufacturers with respect to applicable standards and safety requirements.

Follow corresponding national regulations and safe electrical work practices.

This equipment must only be installed and serviced by qualified personnel. And the qualified personnel is one who has skills and knowledge related to the construction and operation of this electrical equipment and installations, and has received safety training to recognize and avoid the hazards involved.



When operating the Rogowski coil current transducer, there may be dangerous active voltages (e.g. primary conductor) in certain parts of the module. Users should make sure to take all necessary steps to protect against electric shock. The Rogowski coil current transducer is a built-in device containing conductive parts that are inaccessible after installation.

Therefore, a protective enclosure or additional insulation barrier is necessary.

Safe and trouble-free operation of this converter can only be guaranteed if transport, storage and installation are carried out correctly and operation and maintenance are carried out carefully.

## 6. Remark

- $V_o$  is positive when  $I_p$  flows in the direction of the arrow. (o : output, p : primary current)
- Temperature of the primary conductor should not exceed 80°C(176°F).
- Dynamic performances (di/dt and delay time) are the best with a single bar when the primary hole is completely filled.