



KOLLEKTIVWERKS
NO DRILL CENTER MOUNT LICENCE PLATE HOLDER

INSTALLATION GUIDE

SKU: HON11CTR8

HONDA FL5 CIVIC TYPE-R

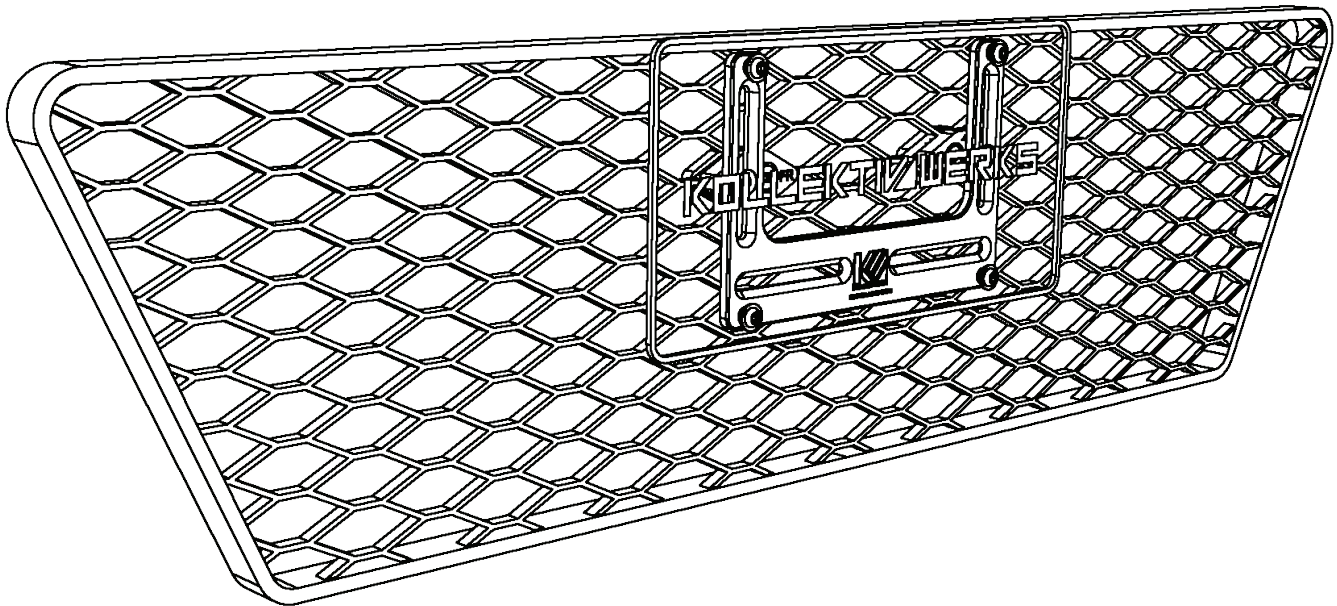

Bill of material:
(scale 1:1)



1x KW 4mm Allen Key Tool

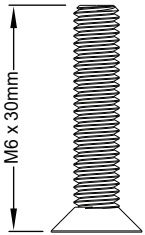

2x

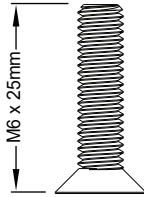

2x

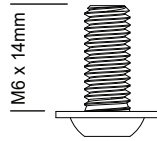

4x

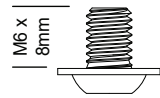

4x



4x

NOTE:
DO NOT SCALE WHEN PRINTING.
PRINT PDF AT "ACTUAL SIZE" SETTING.

Component list:
(not to scale)

1x HON11CTRB-BR

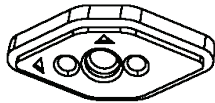

1x HON11CTRB-BL

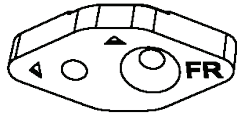
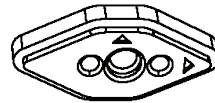

1x HON11CTRB-FR

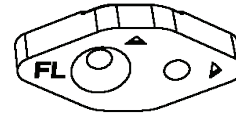

1x HON11CTRB-FL

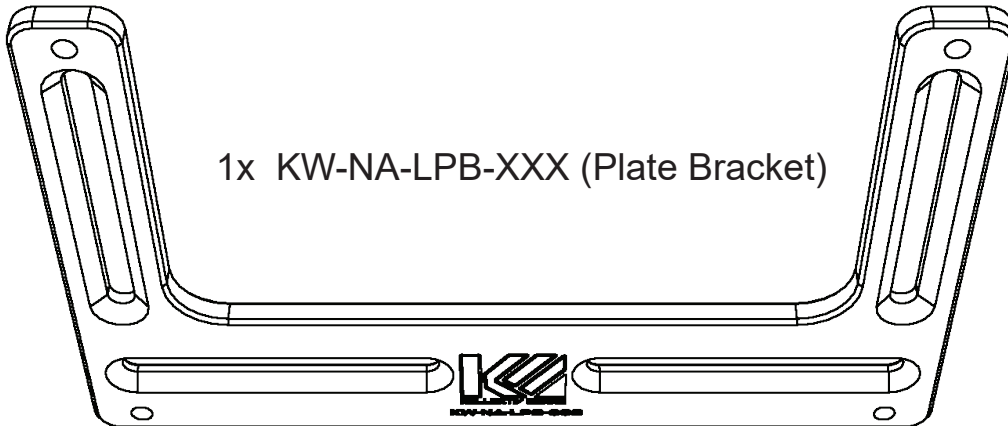

1x KW-NA-LPB-XXX (Plate Bracket)

IMPORTANT!

To be installed in highlighted location only!



Assembly Side View:

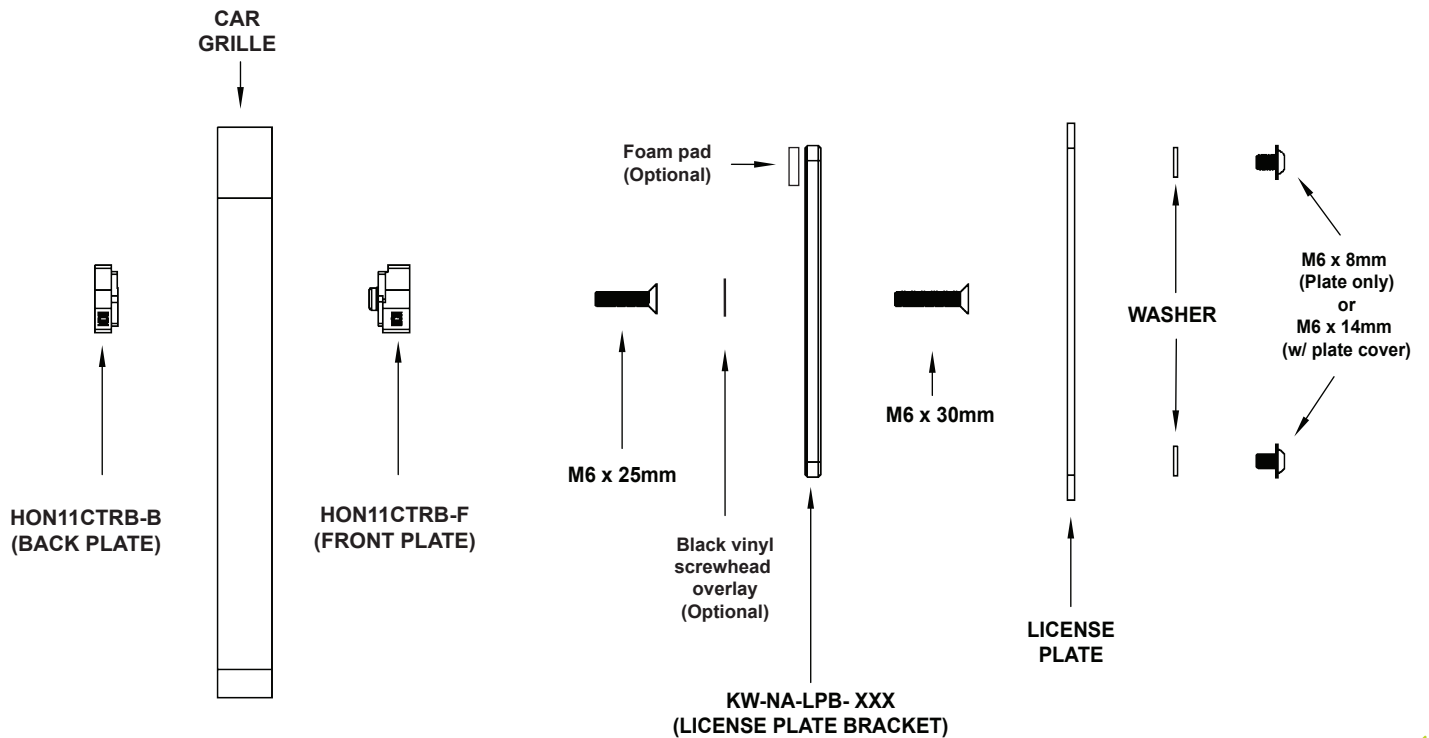

- 1 Insert back plate into the grille and bolt together with front plate. Ensure writing is upright .

DO NOT USE POWER TOOLS!!
DO NOT OVER TIGHTEN!!

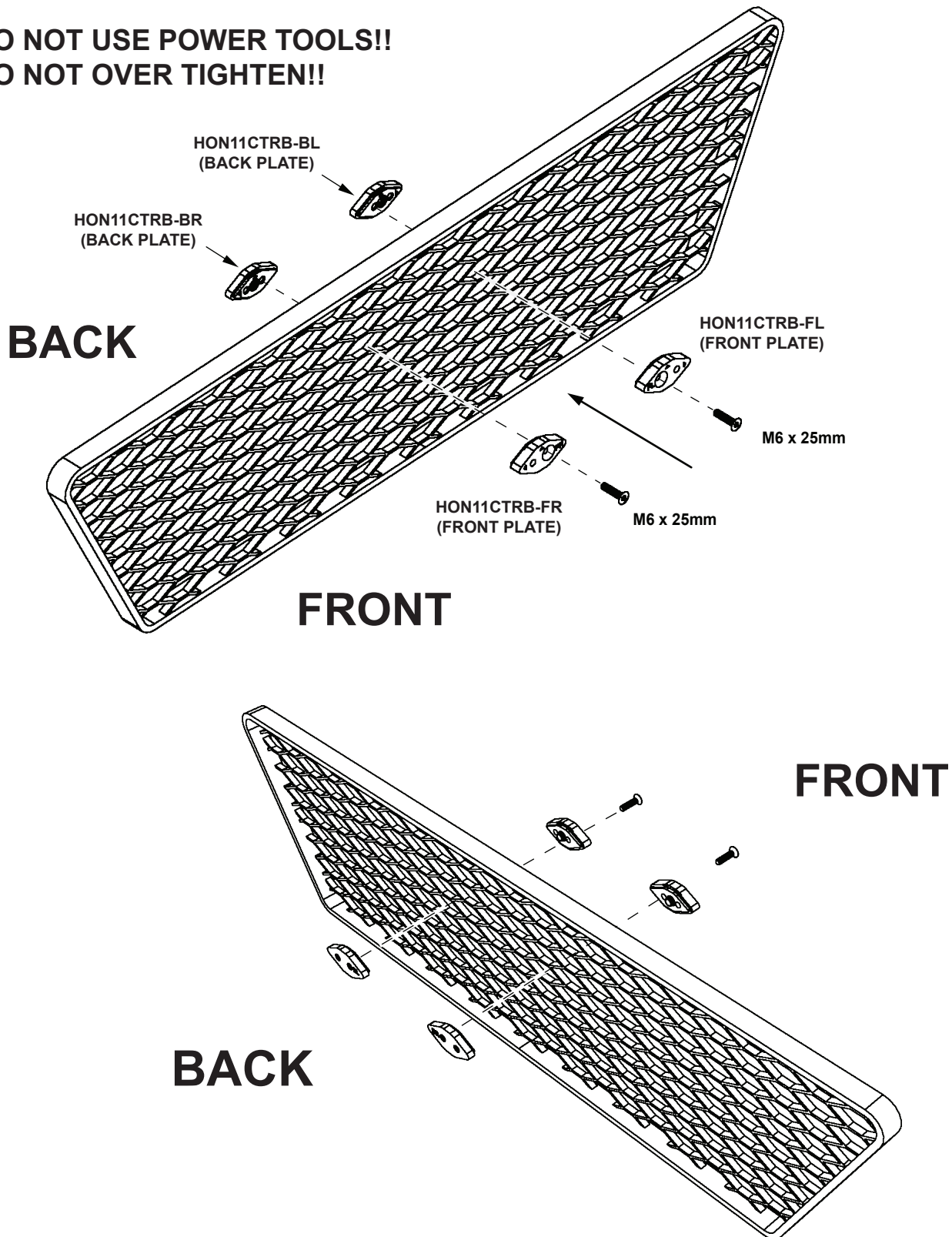

- 2** Install bracket as shown. Center bracket and tighten.
Ensure writing is upright.

DO NOT USE POWER TOOLS!!
DO NOT OVER TIGHTEN!!

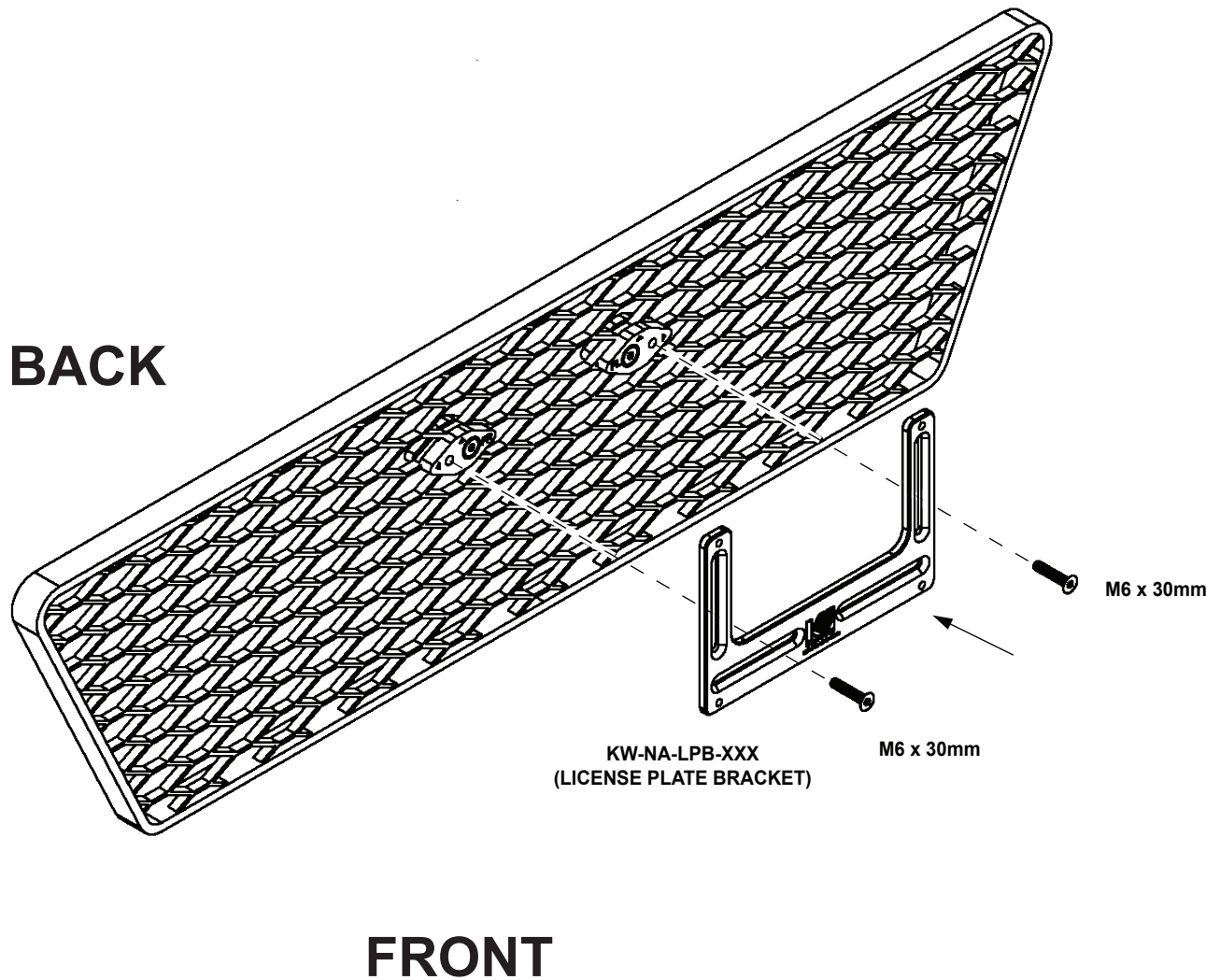

- 3** Install license plate to license plate bracket.
 Install M6x14mm bolts with a license plate cover otherwise use M6x8mm bolts.

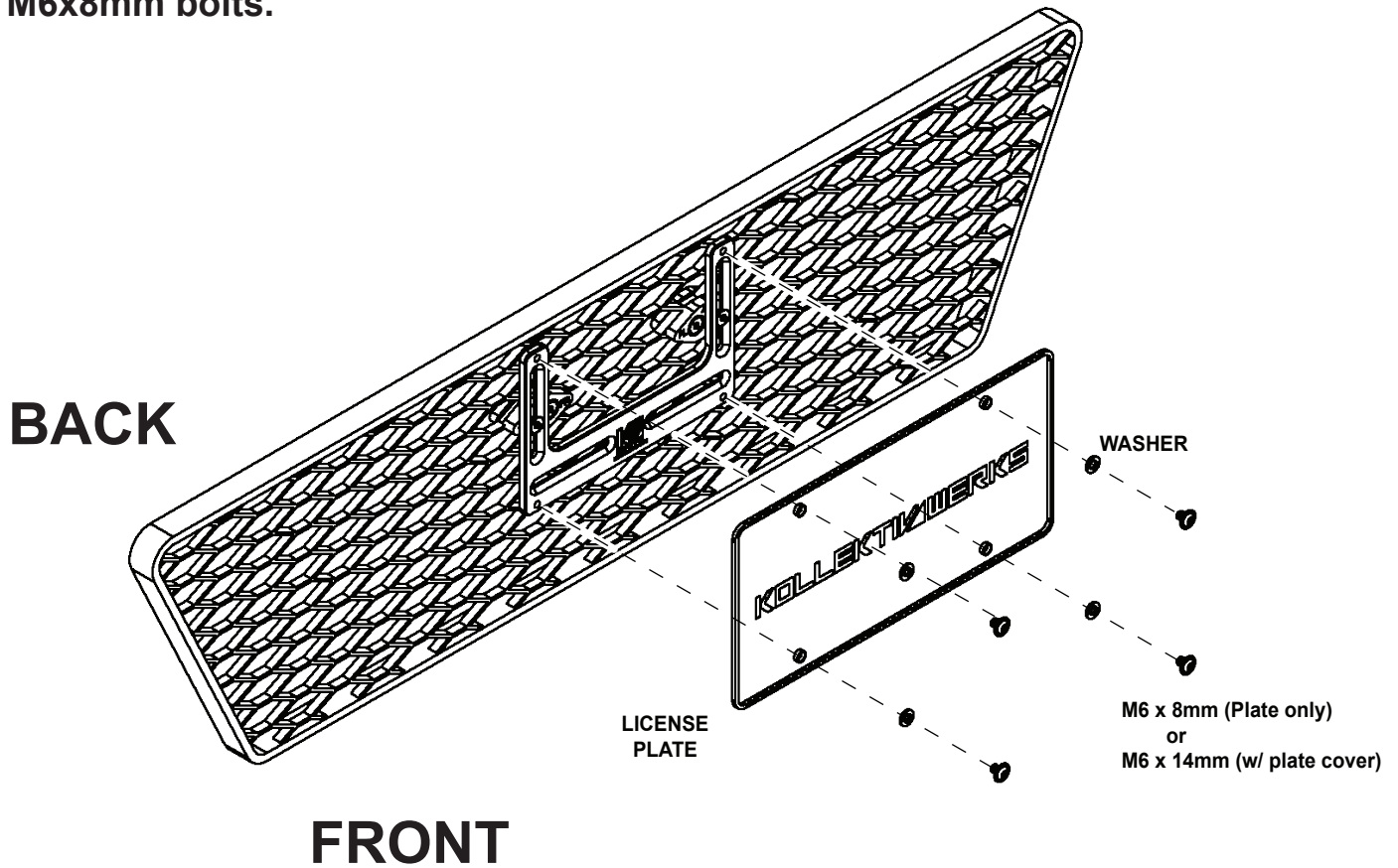

- 4** Enjoy your new KW license plate holder!

