

# CYPHER



CHILLOUT  
SYSTEMS



## REGISTER YOUR SYSTEM

To activate your warranty, products must be registered within 30 days of purchase. Scan the QR code to begin the process or enter the link below.

[chilloutsystems.com/pages/product-registration](https://chilloutsystems.com/pages/product-registration)



## INCLUDED

- 1x Cypher Micro Cooler
- 1x Wired Remote Control
- 1x Fluid kettle
- 1x Rubber isolaters

- 
- 
- 
- 
- 

## SPECIFICATIONS



**RATED COOLING CAPACITY**  
200 watts



**WORKING VOLTAGE**  
24V



**MAX CURRENT**  
7A



**COMPRESSOR**  
Micro Brushless Inverter  
Rated Voltage: 24V



**FAN**  
Axial Flow  
Rated Voltage: 24V



**PUMP**  
Rated Voltage: 24V  
Max Flow: 1.4L/min



**SIZE**  
Length: 7.63in / 194mm  
Width: 3.85in / 98mm



**WEIGHT**  
Cooler: 7.7lbs / 3.5kg



**WATER TEMP SETTINGS**  
Fahrenheit: 32°F, 65°F, 70°F  
Celsius: 0°C, 18°C, 21°C



**OPERTATING TEMPERATURE**  
32°F - 130°F / 0°C - 54.4°C



**STORAGE TEMPERATURE**  
32°F - 140°F / 0°C - 60°C

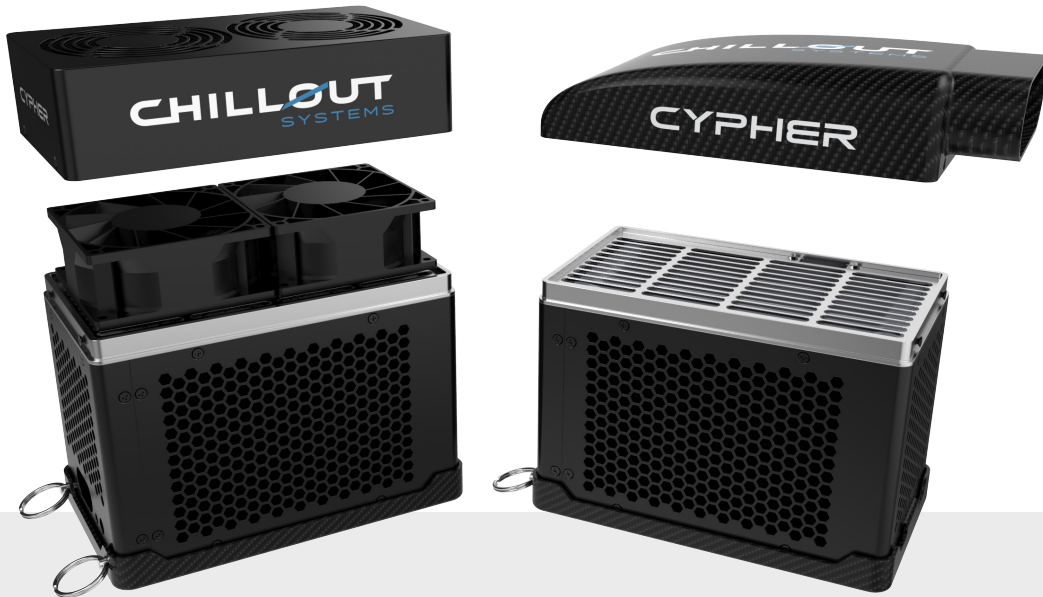

## SYSTEM REMOTE

The Cypher Micro Cooler is controlled by the systems wired remote (included).

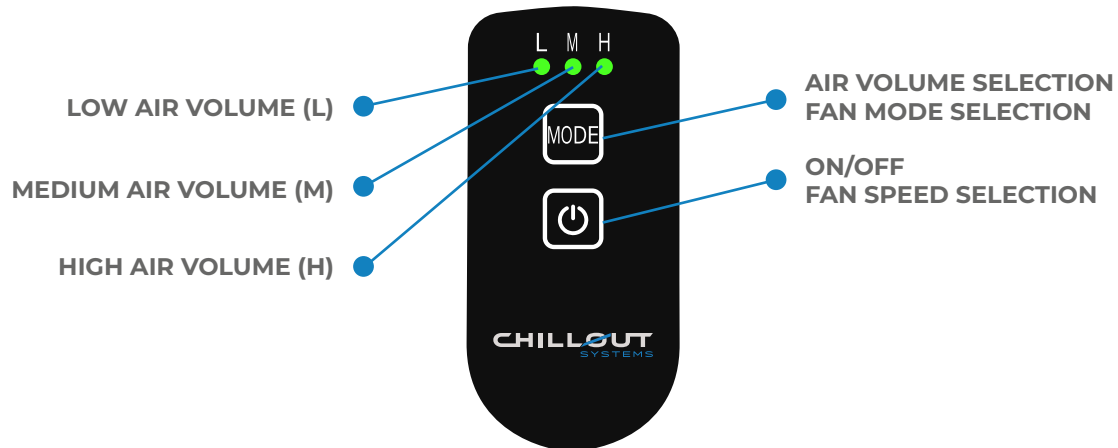

## BUTTON SETTINGS



### ON/OFF

Long press to turn the system On/Off.  
Short press to cycle through the systems 4 fan speeds.



### MODE SELECTION

Short press to change between the three settings (low, medium and high). The selected **Air Volume** is shown on the display. To return, wait 2 seconds and and short press again.

### SWITCH TO EXTERNAL FAN

While the system is OFF, long press MODE for 3 seconds. All three of the Air Volume lights will flash to confirm the system has switched to to an external fan mode.

### SWITCH TO INTERNAL FAN

While the system is OFF, long press MODE for 3 seconds. The Low Air Volume will flash once to confirm the system has switched to internal fan mode.

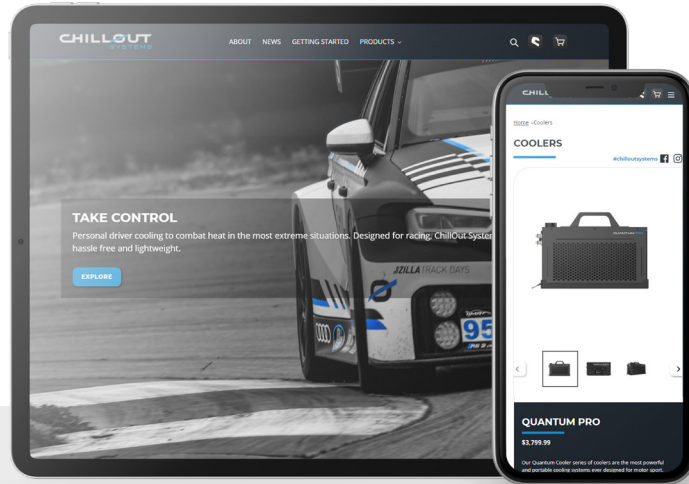

## FREQUENTLY PAIRED TOGETHER

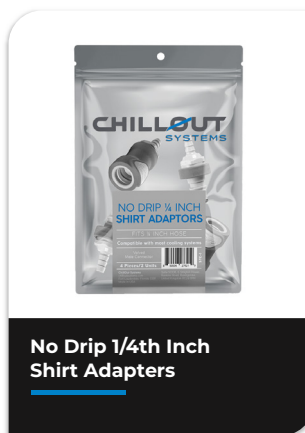
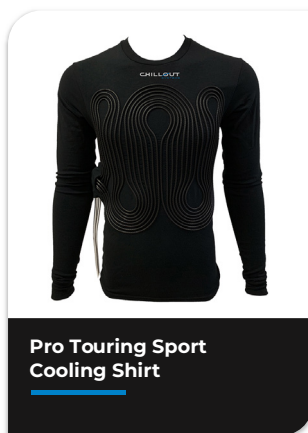
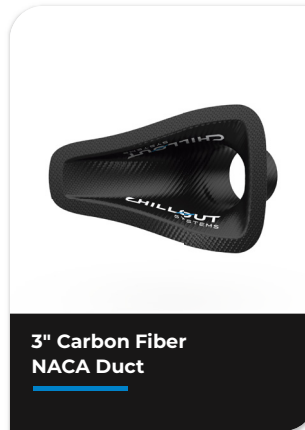
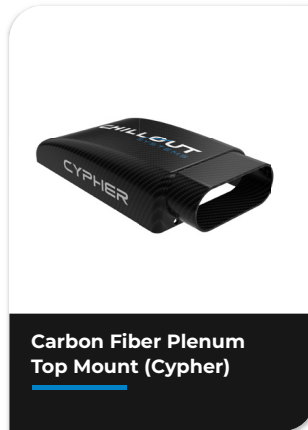
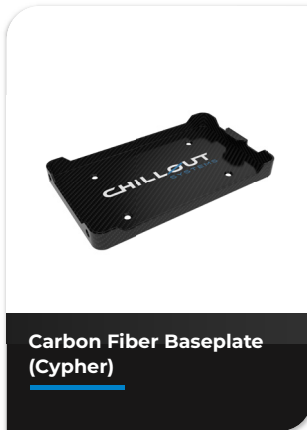

**IT IS RECOMMENDED RUNNING A 3" IN-LINE BLOWER WHEN DUCTING THE CYPHER SYSTEM**

## MOUNTING THE BASEPLATE



- Determine the best location to mount your system inside the car. If possible, keep your system away from any heat sources to ensure maximum cooling efficiency. Ensure there is a sufficient gap between the back of the unit so that the air can circulate freely.

*Note: The Cypher Micro Cooler should be mounted in a horizontal state with a maximum tilt angle of 30°.*

- Place the systems base plate where you have decided to install it and use a sharpie to mark the holes for installation into the vehicle.
- Drill out the holes so that you can install the rivnuts to the vehicle. Once the rivnuts are installed, you can attach the base plate to the vehicle. Be sure to install the provided rubber isolators between the base plate and the installed rivnuts to keep airflow underneath the unit.
- With the base plate now installed, insert the system into the plate and secure with the 2 ball pin connectors.

## INSTALLING THE WIRING



- Connect the wiring harness to the system and run it to your electrical source. This can be directly to the battery with an inline fuse or to a 40amp relay if you are using a switch for the install.
- Once you figure out the length of wire required you can trim the excess and connect it accordingly. (Our wiring harness uses 8 AWG wire)
- Connect the remote wire to the system if you have purchased a remote. We recommend putting the remote somewhere that sun won't directly glare onto it (This can make it hard to read while driving).

## FILLING THE KETTLE



The Cypher Micro Cooler comes with an external kettle for the fluid. The drivers shirt and kettle must be filled with fluid before the system is powered on.

- Mix 1 part *Chillout Systems Coolant Formula* to 1 part deionized water (1:1)
- Unscrew the lid of the kettle and pour in your fluid to just over 2/3's of the kettles volume.
- If you are using Propylene Glycol solution, the volume of concentration should not exceed 25%. If other antifreeze solution is used, its viscosity at 40°F / 25°C should not exceed 2.2mPa·s.

*Note: Purified water is also suitable fluid for the system if **Chillout Systems Coolant Formula** is not available.*

- When turning on the Cypher for the first time you will need to allow the internal pump cycle the fluid through the fluid lines. Before connecting to your shirt allow the system to cycle through and discharge the air in the tubing. This may take a few minutes.

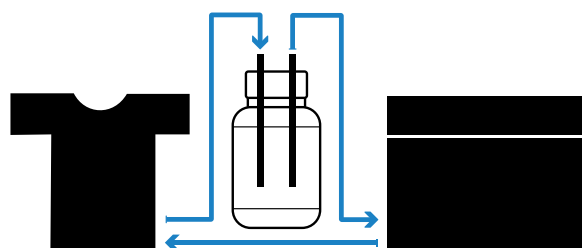

## CONNECTING THE SHIRT



- If you are using a dual prong connector, run the insulated hose from the system to where the driver seat is, making sure there is enough slack to reach the drivers shirt comfortably.
- If you are using **Chillout Systems Rapid Release Kit**, you can either cut and install it to a regular insulated hose or use our Insultated Y-Split Hose.
- When using a Y-Split hose, we recommend keeping a dual prong connector on one side of the seat and installing the rapid release on the opposite side giving you both options in the car for connecting the shirts to the system.

## CONNECTING AN EXTERNAL BLOWER



The Cypher Micro Cooler dual functionality with its internal fans or by adding the Cyphers 4 inch Top Mounted Plenum (sold seperately) and connecting an external 4" inch blower.

- Remove the top mounted fans and attach the **Cypher Top Mounted Plenum**.
- While the system is OFF, long press MODE for 3 seconds. All three of the Air Volume lights will flash to confirm the system has switched to to an external fan mode.
- Connect the Plenum to the in-line blower using 4 inch neoprene ducting.

## DUCTING



- Place the NACA Duct where you have decided to install it and use a sharpie to trace an outline to the vehicle. Once the outline has been traced onto your window, a rotary cutting tool can be used to cut out the outline. We recommend using M4 nuts and bolts to secure the naca duct to a lexan window.

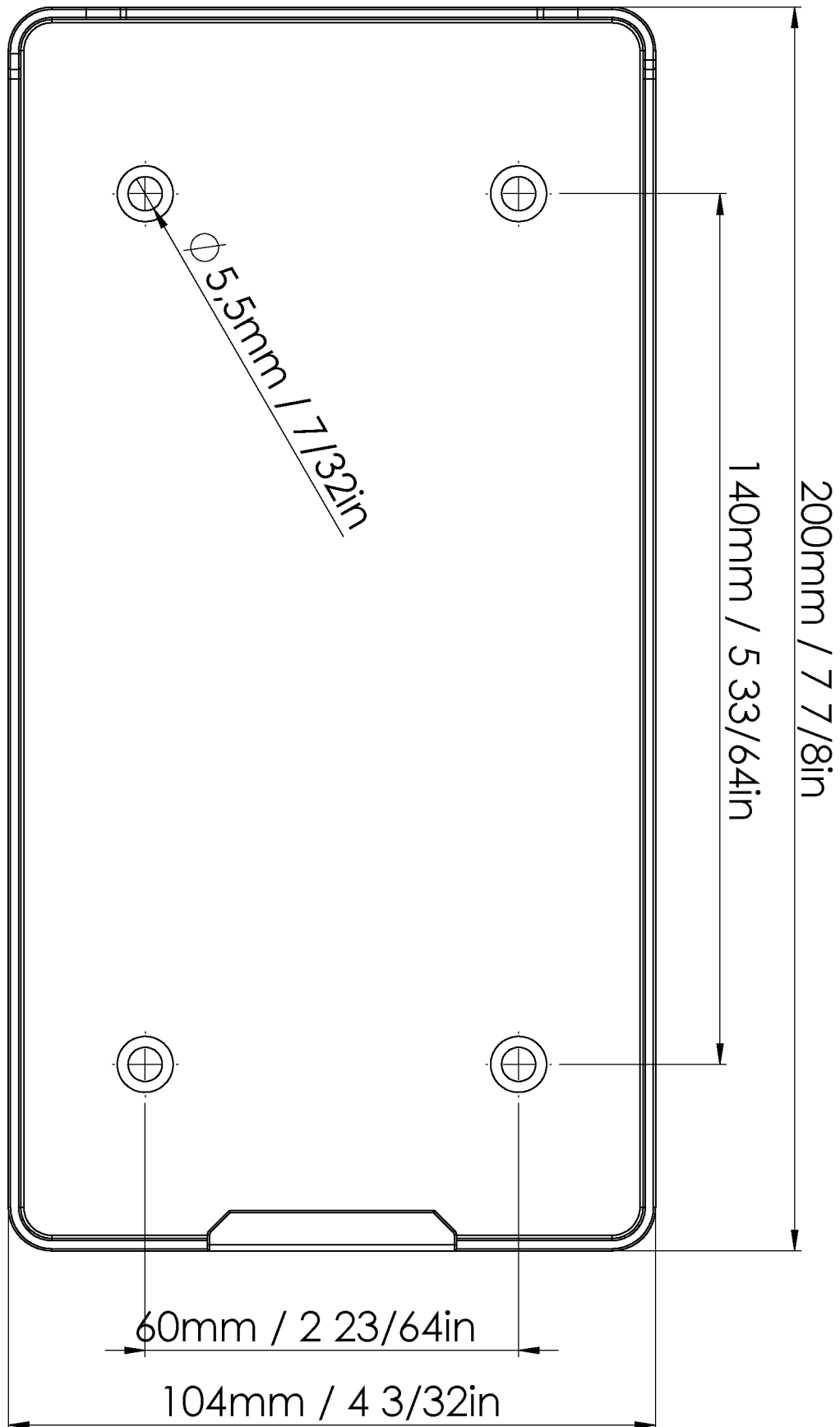

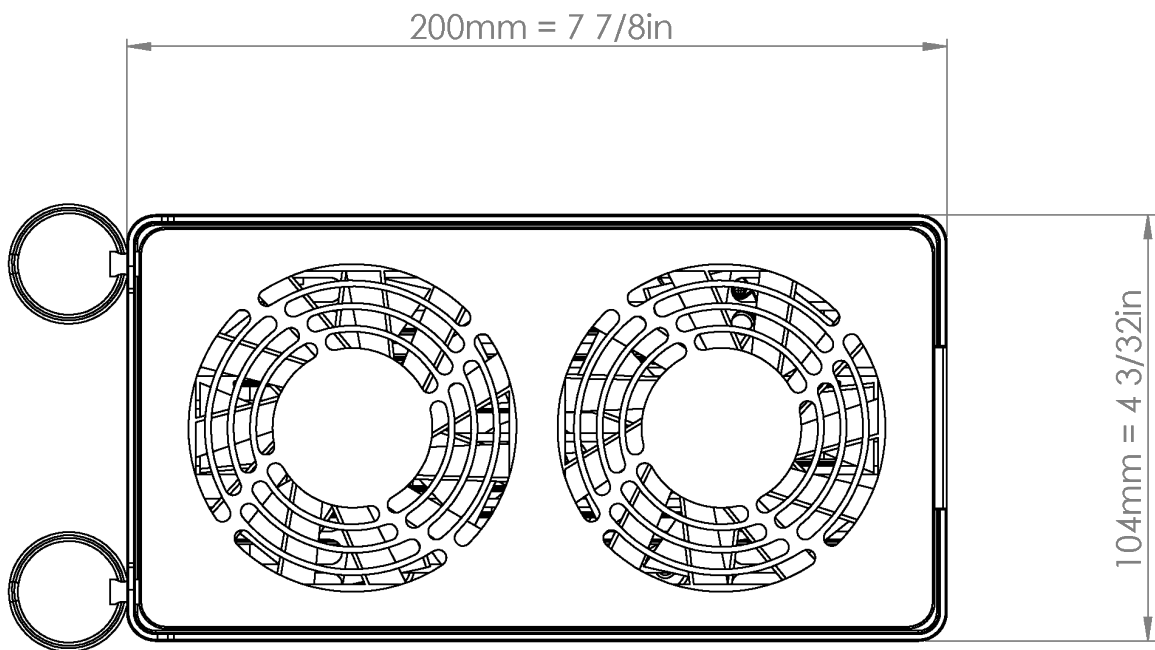
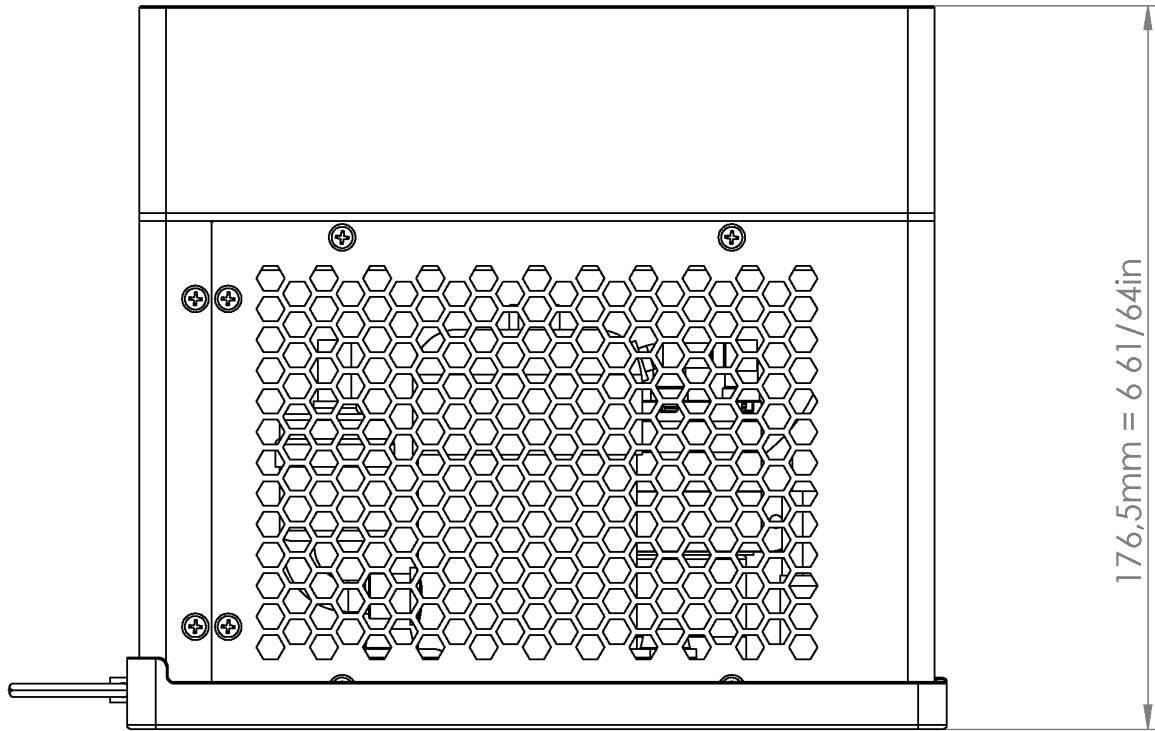





## **EXTEND YOUR PRODUCTS WARRANTY**

---

Add Chillout Service to your purchase order adding an additional 2 years to your systems warranty (36 months total). This includes one free service at any time during the 36 month warranty period.

## **SERVICING**

---

- Deep cleaning of all internals (includes fans, condenser, controller boards).
- Servicing of the cooling system.
- Freon pressure check and top-up (if necessary).
- Performance checks and optimization.

## **REPAIR/REPLACEMENT**

---

In the unlikely event of a failure to your system, within your extended warranty we will expedite a replacement cooler to you via Express Air Service.

Your system will be diagnosed, serviced, repaired and sent back to you.



**CHILLOUT**  
SYSTEMS

# CYPHER

