

MC-108B

HD-SDI EX-SDI HD-TVI CVBS

2MP High Resolution 10x Zoom Module



Features

- 1/2.8" 2MP Sony CMOS Sensor
- 1080p 60fps/30fps, 720p 60fps/30fps
- 10x Optical Zoom(5.1~51mm) & 32x Digital Zoom
- Day & Night(ICR)
- Wide Dynamic Range
- Digital Noise Reduction(2D+3D)
- Privacy Mask Function
- Digital Image Stabilization
- High Light Compensation
- Intelligent Motion Detection
- Defog Function
- Supports VISCA, Pelco-D/P Protocol
- Video Out : HD-TVI, HD-SDI, EX-SDI, CVBS

Field of View

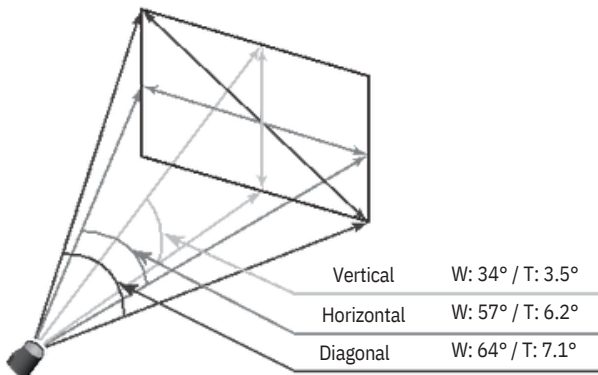

Dimensions

Unit : mm

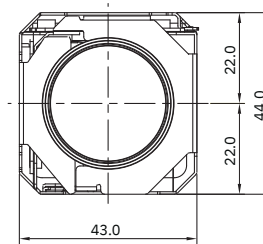

FRONT

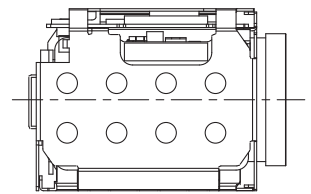

LEFT SIDE

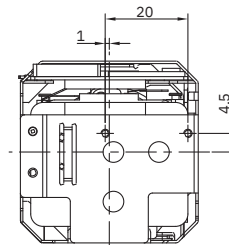

BACK

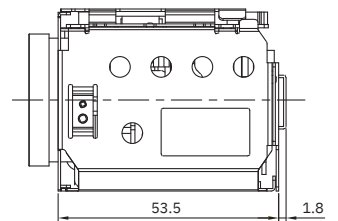

RIGHT SIDE

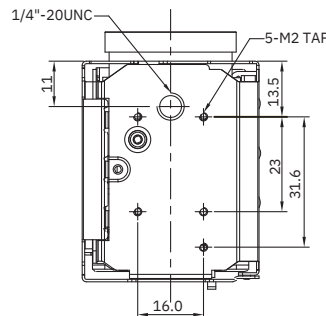

BOTTOM

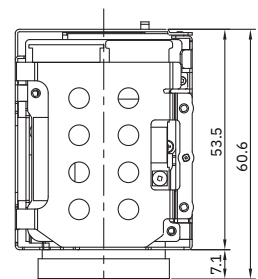

TOP

Specifications

MC-108B				
Image Sensor	1/2.8" Sony CMOS Sensor			
Total Pixels	1,945 (H) x 1,109 (V) = 2.16M Pixels			
Effective Pixels	1,945 (H) x 1,097 (V) = 2.13M Pixels			
Scanning System	Progressive Scan			
Sync. System	Internal			
Resolution	Digital : 1080p/60(50)fps, 1080p/30(25)fps, 720p/60(50)fps, 720p/30(25)fps Analog : 700TVL			
Min. Illumination	Color(1/30s, 60dB) : 0.003 lux, BW(1/30s, 60dB) : 0.0004 lux Color DSS(1/8s, 60dB) : 0.00075 lux , BW DSS(1/8s, 60dB) : 0.0001 lux			
Video Output	HD : HD-TVI, HD-SDI, EX-SDI Analog SD : VBS(without WDR)			
S/N Ratio	more than 50dB(AGC off)			
Lens Type	10x Day & Night Zoom Lens			
Zoom Ratio	Optical 10x, Digital 32x Zoom			
Focal Length	f = 5.1mm ~ 51mm			
Aperture Ratio	F1.6(wide) ~ F1.8(tele)			
Angle Of View(D, H, V)	Wide	64°	57°	34°
	Tele	7.1°	6.2°	3.5°
AF Mode	Auto / One Push / Manual			
Min. Distance	0.1 / 1.0 / 3.0 / 5.0 / 10.0 m			
Lens Refresh	One Push / 1 ~ 10Day			
Digital Zoom	Off / MAX 2x ~ 32x			
Exposure	Auto / Iris.P / Shut.P / Manual			
Gain Control(AGC)	Off / On			
Shutter Speed	1/30(25) ~ 1/30,000 sec			
Iris	0 ~ 20 steps			
Digital Slow Shutter(DSS)	Off / 2x / 4x / (8x : 60 or 50 fps mode only)			
Brightness	0 ~ 20 steps			
WDR/BLC	Off / WDR / BLC			
Day&Night	Auto / Day / Night / Ext-in			
White Balance	Auto / One Push / Manual / Indoor / Outdoor			
HLC	Off / On / Night Only			
DNR	Auto / Off / Low / Middle / High			
Mirror	Off / H / V / H&V			
Sharpness	0 ~ 10 steps			
ACE	Off / Low / Middle / High			
Defog	Off / On(Auto / Manual)			
Privacy Mask	Max. 24 Areas			
Motion Detection	Max. 3 Areas			
Defect Detection	Off / On			
System	NTSC / PAL			
Communication	Baud Rate : 2400 / 4800 / 9600 / 19200 / 38400 / 57600 / 115200 Protocol : VISCA / Pelco-D / Pelco- P / Update			
Language	English / Simplified Chinese / Traditional Chinese / Japanese			
Power Source	9V to 15V DC			
Power Consumption	MAX 400mA			
Power Input	Connector			
Video Output	Connector			
Storage Temperature	-20°C ~ +60°C (Humidity : 0%RH ~ 90%RH)			
Operating Temperature	-10°C ~ +50°C (Humidity : 0%RH ~ 90%RH)			
Dimensions	43(W) x 44(H) x 61(D)			
Weight	112g			

* Design and specifications are subject to change without notice.

Pin Assignment

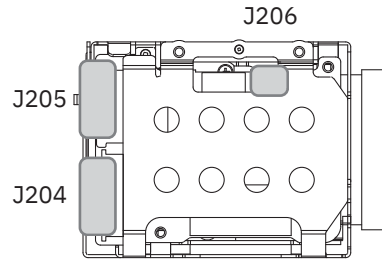

J205	
1	RXD
2	TXD
3	GND
4	DC12V_IN
5	GND
6	VIDEO
7	GND
8	TVI_OUT
9	GND

Ref 6200-509-130(KYOCERA)

J206	
1	HD-SDI Output
2	Board Ground

Ref RF Connector – MMCX

J204	
1	GND
2	TxD
3	RxD
4	TVI ON
5	GND
6	TVI-OUT
7	GND
8	ADKEY
9	IR-ON
10	D/N-IN
11	EX-SDI ON
12	MD-OUT
13	485-DIR
14	F/W_SEL
15	GND
16	+5V_OUT
17	GND
18	VBS-OUT
19	GND
20	DC 12V
21	DC 12V
22	DC 12V
23	DC 12V
24	DC 12V

Ref 05002HR-24J05 (YEONHO)