



Haworth Unigroup Furniture

7540 Roosevelt Road
Forest Park, IL 60130
www.rework-furniture.com
furniture@rework-furniture.com
P 800.763.9100
F 773.379.5221

Price List 2023

Revised: 10.24.2023

Haworth Unigroup

- +Panels.....3-6
 - Non-Powered
 - Powered
 - Add-On Panel
 - Frameless Plexiglass
 - Integrated Frameless Plexiglass
- +Panel Accessories.....7-8
 - Finish Post
 - 4-Way Top Cap
 - Wall Track
 - Wall Mount Kit
 - Base Trim + Power Connector Covers
- +Electrical.....9
 - Top Feed Module
 - Base Feed Module
 - Straight Span Connector
 - Panel-to-Panel Connector
 - Duplex Receptacle
- +Work Surfaces.....10-16
 - Rectangular
 - Corner
 - D-Top
 - Extended Corner
 - Anti-Sag Bar
 - Grommet
 - Scallops
- +Surface Supports.....17-18
 - Cantilever Bracket
 - Side Bracket
 - Flush Mount Plate
 - Tie Plate
 - Rear Corner Bracket
 - Transaction Top Bracket
 - Support -Modesty Panels
 - Gusset Bracket
 - Column Leg
- +Upper Storage.....19
 - Shelves
 - Overhead Units
 - Task Lights
- +Lower Storage.....20
 - Refurbished Pedestals
 - Core + Key

Haworth Unigroup

- +Accessories.....21
 - Tackboards

Fabrics & Finishes

- +Vertical Fabrics.....22
- +Discontinued Vertical Fabrics.....23
- +Paint.....24
- +Laminate.....25
- +Edge Banding.....26

Typical Workstations

- +2' x 6' 53"H Benching.....27
- +6' x 6' 50"H.....27
- +6' x 6' 50/64"H.....27
- +6' x 8' 56/64"H.....27
- +5' x 6' 50"H.....28
- +6' x 6' 50/64"H.....28

COM Yardage

- Fabric Chart.....29-31

Ordering Information

- +Ordering.....32
- +Terms + Conditions.....33
- +Warranty.....34

Non-Powered

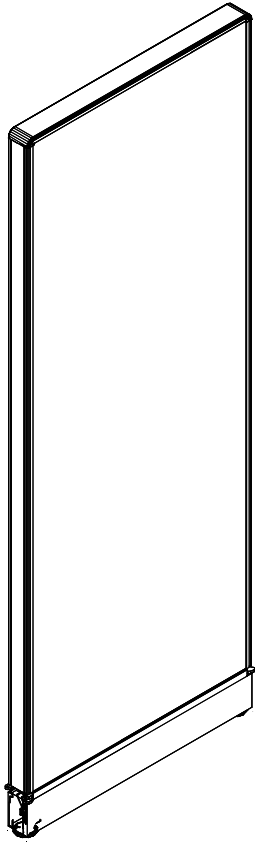

Model No.	Description	List
REFN230	24"W x 30"H Non-Powered Panel	\$ 648
REFN3030	30"W x 30"H Non-Powered Panel	\$ 713
REFN3330	36"W x 30"H Non-Powered Panel	\$ 713
REFN430	48"W x 30"H Non-Powered Panel	\$ 778
REFN530	60"W x 30"H Non-Powered Panel	\$ 843
REFN237	24"W x 37"H Non-Powered Panel	\$ 648
REFN3037	30"W x 37"H Non-Powered Panel	\$ 713
REFN337	36"W x 37"H Non-Powered Panel	\$ 713
REFN437	48"W x 37"H Non-Powered Panel	\$ 778
REFN537	60"W x 37"H Non-Powered Panel	\$ 843
REFN244	24"W x 44"H Non-Powered Panel	\$ 648
REFN3044	30"W x 44"H Non-Powered Panel	\$ 713
REFN344	36"W x 44"H Non-Powered Panel	\$ 713
REFN444	48"W x 44"H Non-Powered Panel	\$ 778
REFN544	60"W x 44"H Non-Powered Panel	\$ 843
REFN250	24"W x 50"H Non-Powered Panel	\$ 648
REFN3050	30"W x 50"H Non-Powered Panel	\$ 713
REFN350	36"W x 50"H Non-Powered Panel	\$ 713
REFN450	48"W x 50"H Non-Powered Panel	\$ 778
REFN550	60"W x 50"H Non-Powered Panel	\$ 843
REFN256	24"W x 56"H Non-Powered Panel	\$ 648
REFN3056	30"W x 56"H Non-Powered Panel	\$ 713
REFN356	36"W x 56"H Non-Powered Panel	\$ 713
REFN456	48"W x 56"H Non-Powered Panel	\$ 778
REFN556	60"W x 56"H Non-Powered Panel	\$ 843
REFN264	24"W x 64"H Non-Powered Panel	\$ 584
REFN3064	30"W x 64"H Non-Powered Panel	\$ 648
REFN364	36"W x 64"H Non-Powered Panel	\$ 648
REFN464	48"W x 64"H Non-Powered Panel	\$ 713
REFN564	60"W x 64"H Non-Powered Panel	\$ 778

To Order, Specify:
 1. Model number
 2. Fabric pattern/colorway
 3. Fabric direction
 4. Paint

800.763.9100
 www.rework-furniture.com
 furniture@rework-furniture.com

Powered

Model No.	Description	List
REFP230	24"W x 30"H Powered Panel	\$ 778
REFP3030	30"W x 30"H Powered Panel	\$ 843
REFP330	36"W x 30"H Powered Panel	\$ 843
REFP430	48"W x 30"H Powered Panel	\$ 908
REFP530	60"W x 30"H Powered Panel	\$ 973
REFP237	24"W x 37"H Powered Panel	\$ 778
REFP3037	30"W x 37"H Powered Panel	\$ 843
REFP337	36"W x 37"H Powered Panel	\$ 843
REFP437	48"W x 37"H Powered Panel	\$ 908
REFP537	60"W x 37"H Powered Panel	\$ 973
REFP244	24"W x 44"H Powered Panel	\$ 778
REFP3044	30"W x 44"H Powered Panel	\$ 843
REFP344	36"W x 44"H Powered Panel	\$ 843
REFP444	48"W x 44"H Powered Panel	\$ 908
REFP544	60"W x 44"H Powered Panel	\$ 973
REFP250	24"W x 50"H Powered Panel	\$ 778
REFP3050	30"W x 50"H Powered Panel	\$ 843
REFP350	36"W x 50"H Powered Panel	\$ 843
REFP450	48"W x 50"H Powered Panel	\$ 908
REFP550	60"W x 50"H Powered Panel	\$ 973
REFP256	24"W x 56"H Powered Panel	\$ 778
REFP3056	30"W x 56"H Powered Panel	\$ 843
REFP356	36"W x 56"H Powered Panel	\$ 843
REFP456	48"W x 56"H Powered Panel	\$ 908
REFP556	60"W x 56"H Powered Panel	\$ 973
REFP264	24"W x 64"H Powered Panel	\$ 713
REFP3064	30"W x 64"H Powered Panel	\$ 778
REFP364	36"W x 64"H Powered Panel	\$ 778
REFP464	48"W x 64"H Powered Panel	\$ 843
REFP564	60"W x 64"H Powered Panel	\$ 908
RCGP	Carpet Grippers- pack of 10	\$ 34

Powered panels include powered retrofit kit and a panel-to-panel

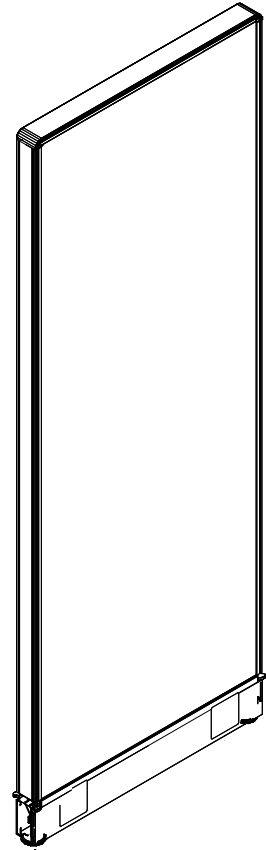

Each powered panel is prefabricated with (4) receptacle sites. Duplexes to be specified separately.

Dimensions:
Side 1: 4-3/8" from edge
Side 2: 3-3/4" from edge

To Order, Specify:
1. Model number
2. Fabric pattern/colorway
3. Fabric direction
4. Paint

800.763.9100
www.rework-furniture.com
furniture@rework-furniture.com

Stacker Panel

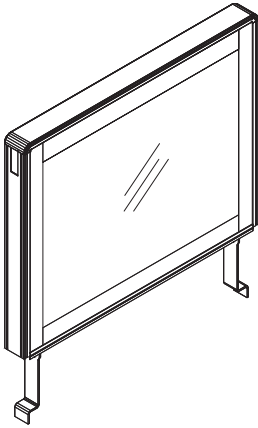

Model No.	Description	List
RAPG2418	24"W x 18"H Clear Plexiglass Add-On Panel	\$ 7 0 0
RAPG3018	30"W x 18"H Clear Plexiglass Add-On Panel	\$ 7 4 6
RAPG3618	36"W x 18"H Clear Plexiglass Add-On Panel	\$ 8 2 4
RAPG4818	48"W x 18"H Clear Plexiglass Add-On Panel	\$ 9 7 8
RAPG6018	60"W x 18"H Clear Plexiglass Add-On Panel	\$ 9 9 2

Top cap not included. This item has a six-week lead time.

Frameless Plexiglass Screen Satin Chrome Panel Mount

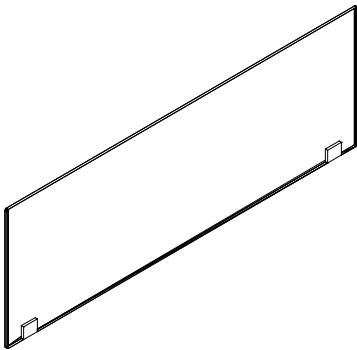

Model No.	Description	List
RFFPG249	24"W x 9"H Frameless Frosted Plexiglass Includes (2) Brackets	\$ 4 3 2
RFFPG309	30"W x 9"H Frameless Frosted Plexiglass Includes (2) Brackets	\$ 5 0 4
RFFPG369	36"W x 9"H Frameless Frosted Plexiglass Includes (2) Brackets	\$ 5 7 6
RFFPG429	42"W x 9"H Frameless Frosted Plexiglass Includes (2) Brackets	\$ 7 2 0
RFFPG489	48"W x 9"H Frameless Frosted Plexiglass Includes (2) Brackets	\$ 7 2 0
RFFPG609	60"W x 9"H Frameless Frosted Plexiglass Includes (3) Brackets	\$ 9 3 6
RFFPG729	72"W x 9"H Frameless Frosted Plexiglass Includes (4) Brackets	\$ 1 1 5 2
RFFPG2412	24"W x 12"H Frameless Frosted Plexiglass Includes (2) Brackets	\$ 4 6 8
RFFPG3012	30"W x 12"H Frameless Frosted Plexiglass Includes (2) Brackets	\$ 5 4 8
RFFPG3612	36"W x 12"H Frameless Frosted Plexiglass Includes (2) Brackets	\$ 6 2 7
RFFPG4212	42"W x 12"H Frameless Frosted Plexiglass Includes (2) Brackets	\$ 7 8 5
RFFPG4812	48"W x 12"H Frameless Frosted Plexiglass Includes (2) Brackets	\$ 7 8 5
RFFPG6012	60"W x 12"H Frameless Frosted Plexiglass Includes (3) Brackets	\$ 1 0 1 6
RFFPG7212	72"W x 12"H Frameless Frosted Plexiglass Includes (4) Brackets	\$ 1 2 5 3
RFGB	Square upmount bracket only- single Size: 2 1/8"W X 15/16"D X 2 1/8"H, Finish: Satin Chrome.	\$ 1 1 7

Two brackets are recommended when spanning multiple panels.
Actual width for all plexiglass screens are 1/2" shorter than listed.
Plexiglass thickness is 1/2".
Custom widths available upon request.

To Order Add on Panels, Specify:
1. Model number
2. Paint

To Order Doors, Specify:
1. Model number
2. Paint

800.763.9100
www.rework-furniture.com
furniture@rework-furniture.com

Frameless Plexiglass Screen Integrated Panel Mount

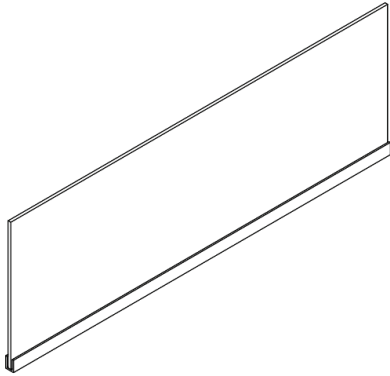

Model No.	Description	List
RIFFFPG249	24"W x 9"H Integrated Frameless Frosted Plexiglass	\$ 5 1 6
RIFFFPG309	30"W x 9"H Integrated Frameless Frosted Plexiglass	\$ 5 8 8
RIFFFPG369	36"W x 9"H Integrated Frameless Frosted Plexiglass	\$ 6 6 0
RIFFFPG429	42"W x 9"H Integrated Frameless Frosted Plexiglass	\$ 8 0 4
RIFFFPG489	48"W x 9"H Integrated Frameless Frosted Plexiglass	\$ 8 0 4
RIFFFPG609	60"W x 9"H Integrated Frameless Frosted Plexiglass	\$ 1 0 2 0
RIFFFPG729	72"W x 9"H Integrated Frameless Frosted Plexiglass	\$ 1 2 3 5
RIFFFPG2412	24"W x 12"H Integrated Frameless Frosted Plexiglass	\$ 5 5 2
RIFFFPG3012	30"W x 12"H Integrated Frameless Frosted Plexiglass	\$ 6 3 2
RIFFFPG3612	36"W x 12"H Integrated Frameless Frosted Plexiglass	\$ 7 1 1
RIFFFPG4212	42"W x 12"H Integrated Frameless Frosted Plexiglass	\$ 8 6 9
RIFFFPG4812	48"W x 12"H Integrated Frameless Frosted Plexiglass	\$ 8 6 9
RIFFFPG6012	60"W x 12"H Integrated Frameless Frosted Plexiglass	\$ 1 1 0 0
RIFFFPG7212	72"W x 12"H Integrated Frameless Frosted Plexiglass	\$ 1 3 3 7

Actual width for all plexiglass screens are 1 1/2" shorter than listed.
Plexiglass thickness is 1/2".
Custom widths available upon request.

Fabric Finish Post

Model No.	Description	List
R 9 0 F F P 3 0	90 Degree Fabric Finish Post 30"H	\$ 6 5
R 9 0 F F P 3 7	90 Degree Fabric Finish Post 37"H	\$ 7 1
R 9 0 F F P 4 4	90 Degree Fabric Finish Post 44"H	\$ 7 1
R 9 0 F F P 5 0	90 Degree Fabric Finish Post 50"H	\$ 7 8
R 9 0 F F P 5 6	90 Degree Fabric Finish Post 56"H	\$ 7 8
R 9 0 F F P 6 4	90 Degree Fabric Finish Post 64"H	\$ 7 8
R 1 8 0 F F P 3 0	180 Degree Fabric Finish Post 30"H	\$ 5 9
R 1 8 0 F F P 3 7	180 Degree Fabric Finish Post 37"H	\$ 5 9
R 1 8 0 F F P 4 4	180 Degree Fabric Finish Post 44"H	\$ 5 9
R 1 8 0 F F P 5 0	180 Degree Fabric Finish Post 50"H	\$ 7 1
R 1 8 0 F F P 5 6	180 Degree Fabric Finish Post 56"H	\$ 7 1
R 1 8 0 F F P 6 4	180 Degree Fabric Finish Post 64"H	\$ 7 1

Finish post include post, top cap, and base trim.

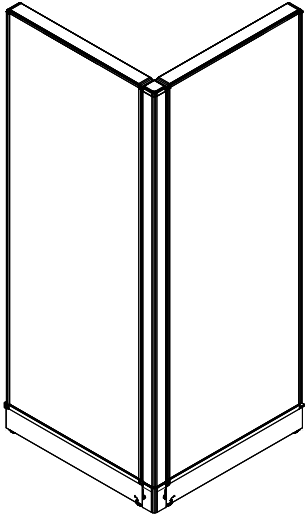

Painted Finish Post

Model No.	Dimensions	List
R 9 0 P F P 3 0	90 Degree Painted Finish Post 30"H	\$ 1 8 5
R 9 0 P F P 3 7	90 Degree Painted Finish Post 37"H	\$ 1 9 1
R 9 0 P F P 4 4	90 Degree Painted Finish Post 44"H	\$ 1 9 1
R 9 0 P F P 5 0	90 Degree Painted Finish Post 50"H	\$ 1 9 8
R 9 0 P F P 5 6	90 Degree Painted Finish Post 56"H	\$ 1 9 8
R 9 0 P F P 6 4	90 Degree Painted Finish Post 64"H	\$ 1 9 8
R 1 8 0 P F P 3 0	180 Degree Painted Finish Post 30"H	\$ 1 7 9
R 1 8 0 P F P 3 7	180 Degree Painted Finish Post 37"H	\$ 1 7 9
R 1 8 0 P F P 4 4	180 Degree Painted Finish Post 44"H	\$ 1 9 1
R 1 8 0 P F P 5 0	180 Degree Painted Finish Post 50"H	\$ 1 9 1
R 1 8 0 P F P 5 6	180 Degree Painted Finish Post 56"H	\$ 1 9 1
R 1 8 0 P F P 6 4	180 Degree Painted Finish Post 64"H	\$ 1 9 1

Finish post include post, top cap, and base trim.

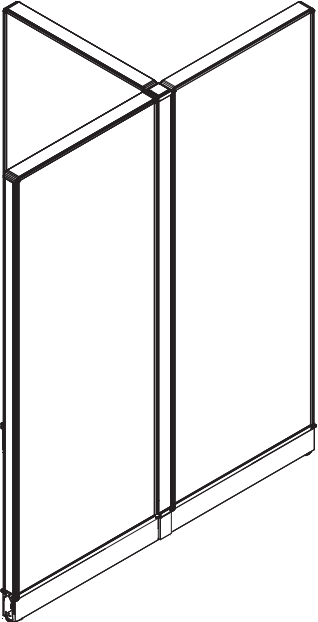

To Order Fabric Finish Post, Specify:

1. Model number
2. Fabric pattern/colorway
3. Fabric direction
4. Paint

To Order Painted Finish Post, Base Trim + Power Connector Covers, Specify:

1. Model number
2. Paint

800.763.9100
www.rework-furniture.com
furniture@rework-furniture.com

4-Way Top Cap

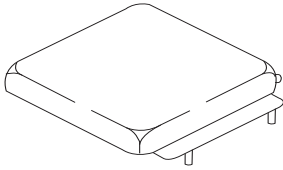

Model No.	Description	List
R4TC	4-Way Top Cap	\$84

Wall Track

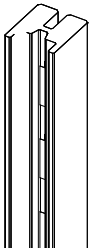

Model No.	Description	List
RWT72	Wall Track 72"H	\$117

Wall track can be cut down when shorter heights are required.

Wall Mount Kit

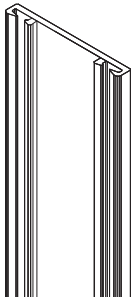

Model No.	Description	List
R W M K 3 0	Wall Mount Kit 30"H	\$ 5 2
R W M K 3 7	Wall Mount Kit 37"H	\$ 5 9
R W M K 4 4	Wall Mount Kit 44"H	\$ 6 5
R W M K 5 0	Wall Mount Kit 50"H	\$ 7 1
R W M K 5 6	Wall Mount Kit 56"H	\$ 7 8
R W M K 6 4	Wall Mount Kit 64"H	\$ 9 2

Base Trim + Power Connector Covers

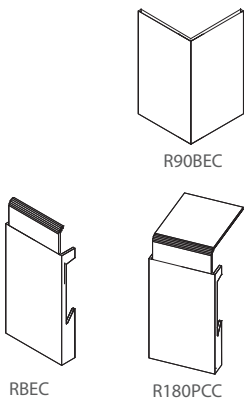

Model No.	Dimensions	List
RBEC	Base End Cap	\$20
R90BEC	90 Degree Base End Cap	\$20
R180PCC	180 Degree Power Connector Cover	\$20

Order power connector covers to cover the power connection when finish posts are not specified.

To Order, Specify:
1. Model number
2. Paint

800.763.9100
www.rework-furniture.com
furniture@rework-furniture.com

Top Feed Module - 3 Circuit

Model No.	Description	List
RTFP	Top Feed Module for ceilings 10' and under	\$875
RTF	Top Feed Module for ceilings 10' and under, pole only	\$551

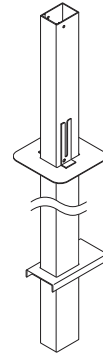

Base Feed Module - 3 Circuit

Model No.	Description	List
RBF	Base Feed Module *Base feed run in one direction and are left-handed	\$778

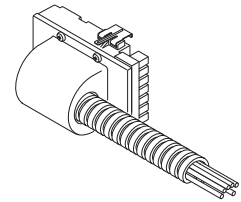

Straight Span Connector

Model No.	Description	List
RSS	Extended Straight Span Connector	\$65
RPP	Panel-to-Panel Connector	\$65

-Extended straight span connector is used to pass power thru 3 and 4-way connections.

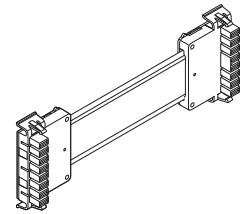

Duplex Receptacle - 3 Circuit

Model No.	Description	List
RDR	15 amp Duplex Receptacle 2 outlets with 3 field inter-changeable circuits.	\$20

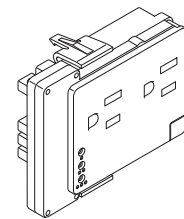

To Order, Specify:
1. Model number
2. Paint

Rectangular

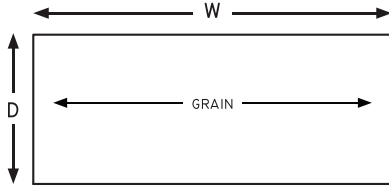

W= Exact Size
 12"D= Exact Size
 18"D= Exact Size
 24"D= 23 1/4"D
 30"D= 29 1/4"D

Specifications:

- Square corners
- LP (Thermal Fused Laminate) - 1 1/8" thick
- HP (High Pressure Laminate) - 1 1/4" thick
- Please specify LP or HP
- PolyBak on underside
- 2mm Edge banding on all sides
- Use with Supports on page 17-18

Model No.	Description	LP	HP
RWSS1224	12"D x 24"W Rectangular Work Surface	\$ 107	\$ 145
RWSS1230	12"D x 30"W Rectangular Work Surface	\$ 127	\$ 176
RWSS1236	12"D x 36"W Rectangular Work Surface	\$ 148	\$ 205
RWSS1242	12"D x 42"W Rectangular Work Surface	\$ 173	\$ 237
RWSS1248	12"D x 48"W Rectangular Work Surface	\$ 196	\$ 270
RWSS1260	12"D x 60"W Rectangular Work Surface	\$ 238	\$ 328
RWSS1266	12"D x 66"W Rectangular Work Surface	\$ 261	\$ 360
RWSS1272	12"D x 72"W Rectangular Work Surface	\$ 284	\$ 392
RWSS1284	12"D x 84"W Rectangular Work Surface	\$ 328	\$ 453
RWSS1296	12"D x 96"W Rectangular Work Surface	\$ 377	\$ 517
RWSS12108	12"D x 108"W Rectangular Work Surface	\$ 417	\$ 579
RWSS12120	12"D x 120"W Rectangular Work Surface	\$ 465	\$ 639
RWSS12144	12"D x 144"W Rectangular Work Surface	\$ 553	\$ 761
RWSS1824	18"D x 24"W Rectangular Work Surface	\$ 119	\$ 165
RWSS1830	18"D x 30"W Rectangular Work Surface	\$ 145	\$ 199
RWSS1836	18"D x 36"W Rectangular Work Surface	\$ 170	\$ 234
RWSS1842	18"D x 42"W Rectangular Work Surface	\$ 210	\$ 287
RWSS1848	18"D x 48"W Rectangular Work Surface	\$ 220	\$ 304
RWSS1860	18"D x 60"W Rectangular Work Surface	\$ 273	\$ 376
RWSS1866	18"D x 66"W Rectangular Work Surface	\$ 297	\$ 410
RWSS1872	18"D x 72"W Rectangular Work Surface	\$ 322	\$ 444
RWSS1884	18"D x 84"W Rectangular Work Surface	\$ 412	\$ 569
RWSS1896	18"D x 96"W Rectangular Work Surface	\$ 425	\$ 586
RWSS18108	18"D x 108"W Rectangular Work Surface	\$ 430	\$ 652
RWSS18120	18"D x 120"W Rectangular Work Surface	\$ 525	\$ 725
RWSS18144	18"D x 144"W Rectangular Work Surface	\$ 625	\$ 865
RWSS2424	24"D x 24"W Rectangular Work Surface	\$ 143	\$ 195
RWSS2430	24"D x 30"W Rectangular Work Surface	\$ 170	\$ 234
RWSS2436	24"D x 36"W Rectangular Work Surface	\$ 199	\$ 275
RWSS2442	24"D x 42"W Rectangular Work Surface	\$ 253	\$ 349
RWSS2448	24"D x 48"W Rectangular Work Surface	\$ 259	\$ 356
RWSS2460	24"D x 60"W Rectangular Work Surface	\$ 318	\$ 436
RWSS2466	24"D x 66"W Rectangular Work Surface	\$ 347	\$ 478
RWSS2472	24"D x 72"W Rectangular Work Surface	\$ 376	\$ 519
RWSS2484	24"D x 84"W Rectangular Work Surface	\$ 482	\$ 663
RWSS2496	24"D x 96"W Rectangular Work Surface	\$ 492	\$ 678
RWSS24108	24"D x 108"W Rectangular Work Surface	\$ 600	\$ 828
RWSS24120	24"D x 120"W Rectangular Work Surface	\$ 608	\$ 842
RWSS24144	24"D x 144"W Rectangular Work Surface	\$ 726	\$ 1003
RWSS3024	30"D x 24"W Rectangular Work Surface	\$ 176	\$ 239
RWSS3030	30"D x 30"W Rectangular Work Surface	\$ 206	\$ 284
RWSS3036	30"D x 36"W Rectangular Work Surface	\$ 240	\$ 330
RWSS3042	30"D x 42"W Rectangular Work Surface	\$ 307	\$ 421
RWSS3048	30"D x 48"W Rectangular Work Surface	\$ 310	\$ 430
RWSS3060	30"D x 60"W Rectangular Work Surface	\$ 381	\$ 527
RWSS3066	30"D x 66"W Rectangular Work Surface	\$ 417	\$ 576
RWSS3072	30"D x 72"W Rectangular Work Surface	\$ 451	\$ 625
RWSS3084	30"D x 84"W Rectangular Work Surface	\$ 580	\$ 804
RWSS3096	30"D x 96"W Rectangular Work Surface	\$ 593	\$ 817
RWSS30108	30"D x 108"W Rectangular Work Surface	\$ 720	\$ 995
RWSS30120	30"D x 120"W Rectangular Work Surface	\$ 731	\$ 1010
RWSS30144	30"D x 144"W Rectangular Work Surface	\$ 875	\$ 1207

To Order, Specify:
 1. Model number
 2. Laminate
 3. Edge banding

800.763.9100
www.rework-furniture.com
furniture@rework-furniture.com

Straight Corner

Model No.	Description	LP	HP
RSCS2436	24"D x 36"W Straight Corner Work Surface	\$ 2 77	\$ 3 83
RSCS2442	24"D x 42"W Straight Corner Work Surface	\$ 4 07	\$ 5 62
RSCS2448	24"D x 48"W Straight Corner Work Surface	\$ 4 64	\$ 6 39
RSCS3042	30"D x 42"W Straight Corner Work Surface	\$ 4 08	\$ 5 62
RSCS3048	30"D x 48"W Straight Corner Work Surface	\$ 4 64	\$ 6 39

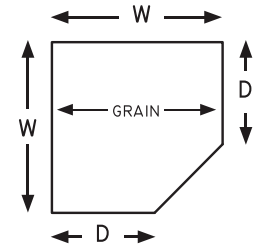

36"W= 35 1/4"W
 42"W= 41 1/4"W
 48"W= 47 1/4"W
 24"D= 23 1/4"D
 30"D= 29 1/4"D

Curved Corner

Model No.	Description	LP	HP
RCCS2436	24"D x 36"W Curved Corner Work Surface	\$ 3 35	\$ 4 58
RCCS2442	24"D x 42"W Curved Corner Work Surface	\$ 4 74	\$ 6 51
RCCS2448	24"D x 48"W Curved Corner Work Surface	\$ 5 38	\$ 7 43
RCCS3042	30"D x 42"W Curved Corner Work Surface	\$ 4 74	\$ 6 51
RCCS3048	30"D x 48"W Curved Corner Work Surface	\$ 5 38	\$ 7 43

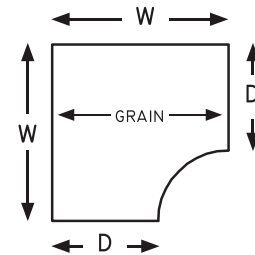

36"W= 35 1/4"W
 42"W= 41 1/4"W
 48"W= 47 1/4"W
 24"D= 23 1/4"D
 30"D= 29 1/4"D

D-Top

Model No.	Description	LP	HP
RDT2448	24"D x 48"W D-Top Work Surface	\$ 3 45	\$ 4 78
RDT2460	24"D x 60"W D-Top Work Surface	\$ 4 19	\$ 6 04
RDT2466	24"D x 66"W D-Top Work Surface	\$ 4 82	\$ 6 63
RDT2472	24"D x 72"W D-Top Work Surface	\$ 4 92	\$ 6 82
RDT3048	30"D x 48"W D-Top Work Surface	\$ 4 08	\$ 5 63
RDT3060	30"D x 60"W D-Top Work Surface	\$ 4 92	\$ 7 06
RDT3066	30"D x 66"W D-Top Work Surface	\$ 5 63	\$ 7 79
RDT3072	30"D x 72"W D-Top Work Surface	\$ 5 77	\$ 7 97
RDT3648	36"D x 48"W D-Top Work Surface	\$ 4 68	\$ 6 47
RDT3660	36"D x 60"W D-Top Work Surface	\$ 5 63	\$ 7 79
RDT3666	36"D x 66"W D-Top Work Surface	\$ 6 47	\$ 8 94
RDT3672	36"D x 72"W D-Top Work Surface	\$ 6 61	\$ 9 14

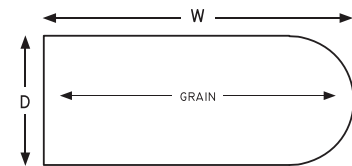

W= Exact Size
 D= Exact Size

To Order, Specify:
 1. Model number
 2. Laminate
 3. Edge banding

800.763.9100
www.rework-furniture.com
furniture@rework-furniture.com

Extended Corner- Left

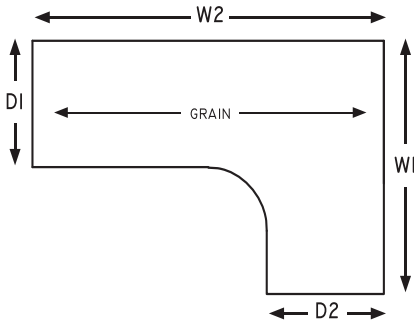

- 36"W= 35 1/4"W
- 42"W= 41 1/4"W
- 60"W= 59 1/4"W
- 72"W= 71 1/4"W
- 84"W= 83 1/4"W
- 96"W= 95 1/4"W
- 24"D= 23 1/4"D
- 30"D= 29 1/4"D

Model No.	W1 x W2 x D1 x D2	LP	HP
RECSL36602424	36 x 60 x 24 x 24 Extended Corner Work Surface	\$ 453	\$ 628
RECSL36602430	36 x 60 x 24 x 30 Extended Corner Work Surface	\$ 453	\$ 628
RECSL36603024	36 x 60 x 30 x 24 Extended Corner Work Surface	\$ 453	\$ 628
RECSL36603030	36 x 60 x 30 x 30 Extended Corner Work Surface	\$ 453	\$ 628
RECSL36722424	36 x 72 x 24 x 24 Extended Corner Work Surface	\$ 538	\$ 743
RECSL36722430	36 x 72 x 24 x 30 Extended Corner Work Surface	\$ 538	\$ 743
RECSL36723024	36 x 72 x 30 x 24 Extended Corner Work Surface	\$ 538	\$ 743
RECSL36723030	36 x 72 x 30 x 30 Extended Corner Work Surface	\$ 538	\$ 743
RECSL36842424	36 x 84 x 24 x 24 Extended Corner Work Surface	\$ 623	\$ 859
RECSL36842430	36 x 84 x 24 x 30 Extended Corner Work Surface	\$ 623	\$ 859
RECSL36843024	36 x 84 x 30 x 24 Extended Corner Work Surface	\$ 623	\$ 859
RECSL36843030	36 x 84 x 30 x 30 Extended Corner Work Surface	\$ 623	\$ 859
RECSL36962424	36 x 96 x 24 x 24 Extended Corner Work Surface	\$ 702	\$ 975
RECSL36962430	36 x 96 x 24 x 30 Extended Corner Work Surface	\$ 702	\$ 975
RECSL36963024	36 x 96 x 30 x 24 Extended Corner Work Surface	\$ 702	\$ 975
RECSL36963030	36 x 96 x 30 x 30 Extended Corner Work Surface	\$ 702	\$ 975
RECSL42602424	42 x 60 x 24 x 24 Extended Corner Work Surface	\$ 505	\$ 696
RECSL42602430	42 x 60 x 24 x 30 Extended Corner Work Surface	\$ 505	\$ 696
RECSL42603024	42 x 60 x 30 x 24 Extended Corner Work Surface	\$ 505	\$ 696
RECSL42603030	42 x 60 x 30 x 30 Extended Corner Work Surface	\$ 505	\$ 696
RECSL42722424	42 x 72 x 24 x 24 Extended Corner Work Surface	\$ 597	\$ 7824
RECSL42722430	42 x 72 x 24 x 30 Extended Corner Work Surface	\$ 597	\$ 824
RECSL42723024	42 x 72 x 30 x 24 Extended Corner Work Surface	\$ 597	\$ 824
RECSL42723030	42 x 72 x 30 x 30 Extended Corner Work Surface	\$ 597	\$ 824
RECSL42842424	42 x 84 x 24 x 24 Extended Corner Work Surface	\$ 690	\$ 954
RECSL42842430	42 x 84 x 24 x 30 Extended Corner Work Surface	\$ 690	\$ 954
RECSL42843024	42 x 84 x 30 x 24 Extended Corner Work Surface	\$ 690	\$ 954
RECSL42843030	42 x 84 x 30 x 30 Extended Corner Work Surface	\$ 690	\$ 954
RECSL42962424	42 x 96 x 24 x 24 Extended Corner Work Surface	\$ 784	\$ 1082
RECSL42962430	42 x 96 x 24 x 30 Extended Corner Work Surface	\$ 784	\$ 1082
RECSL42963024	42 x 96 x 30 x 24 Extended Corner Work Surface	\$ 784	\$ 1082
RECSL42963030	42 x 96 x 30 x 30 Extended Corner Work Surface	\$ 784	\$ 1082

To Order, Specify:
 1. Model number
 2. Laminate
 3. Edge banding

800.763.9100
www.rework-furniture.com
furniture@rework-furniture.com

Extended Corner- Left

Model No.	W1 x W2 x D1 x D2	LP	HP
RECSL48602424	48 x 60 x 24 x 24 Extended Corner Work Surface	\$ 5 6 9	\$ 7 8 3
RECSL48602430	48 x 60 x 24 x 30 Extended Corner Work Surface	\$ 5 6 9	\$ 7 8 3
RECSL48603024	48 x 60 x 30 x 24 Extended Corner Work Surface	\$ 5 6 9	\$ 7 8 3
RECSL48603030	48 x 60 x 30 x 30 Extended Corner Work Surface	\$ 5 6 9	\$ 7 8 3
RECSL48722424	48 x 72 x 24 x 24 Extended Corner Work Surface	\$ 6 7 1	\$ 9 3 0
RECSL48722430	48 x 72 x 24 x 30 Extended Corner Work Surface	\$ 6 7 1	\$ 9 3 0
RECSL48723024	48 x 72 x 30 x 24 Extended Corner Work Surface	\$ 6 7 1	\$ 9 3 0
RECSL48723030	48 x 72 x 30 x 30 Extended Corner Work Surface	\$ 6 7 1	\$ 9 3 0
RECSL48842424	48 x 84 x 24 x 24 Extended Corner Work Surface	\$ 7 7 9	\$ 1 0 7 5
RECSL48842430	48 x 84 x 24 x 30 Extended Corner Work Surface	\$ 7 7 9	\$ 1 0 7 5
RECSL48843024	48 x 84 x 30 x 24 Extended Corner Work Surface	\$ 7 7 9	\$ 1 0 7 5
RECSL48843030	48 x 84 x 30 x 30 Extended Corner Work Surface	\$ 7 7 9	\$ 1 0 7 5
RECSL48962424	48 x 96 x 24 x 24 Extended Corner Work Surface	\$ 8 8 3	\$ 1 2 2 1
RECSL48962430	48 x 96 x 24 x 30 Extended Corner Work Surface	\$ 8 8 3	\$ 1 2 2 1
RECSL48963024	48 x 96 x 30 x 24 Extended Corner Work Surface	\$ 8 8 3	\$ 1 2 2 1
RECSL48963030	48 x 96 x 30 x 30 Extended Corner Work Surface	\$ 8 8 3	\$ 1 2 2 1
RECSL60602424	60 x 60 x 24 x 24 Extended Corner Work Surface	\$ 6 9 8	\$ 9 6 4
RECSL60602430	60 x 60 x 24 x 30 Extended Corner Work Surface	\$ 6 9 8	\$ 9 6 4
RECSL60603024	60 x 60 x 30 x 24 Extended Corner Work Surface	\$ 6 9 8	\$ 9 6 4
RECSL60603030	60 x 60 x 30 x 30 Extended Corner Work Surface	\$ 6 9 8	\$ 9 6 4
RECSL60722424	60 x 72 x 24 x 24 Extended Corner Work Surface	\$ 8 2 8	\$ 1 1 4 1
RECSL60722430	60 x 72 x 24 x 30 Extended Corner Work Surface	\$ 8 2 8	\$ 1 1 4 1
RECSL60723024	60 x 72 x 30 x 24 Extended Corner Work Surface	\$ 8 2 8	\$ 1 1 4 1
RECSL60723030	60 x 72 x 30 x 30 Extended Corner Work Surface	\$ 8 2 8	\$ 1 1 4 1
RECSL60842424	60 x 84 x 24 x 24 Extended Corner Work Surface	\$ 9 5 4	\$ 1 3 1 5
RECSL60842430	60 x 84 x 24 x 30 Extended Corner Work Surface	\$ 9 5 4	\$ 1 3 1 5
RECSL60843024	60 x 84 x 30 x 24 Extended Corner Work Surface	\$ 9 5 4	\$ 1 3 1 5
RECSL60843030	60 x 84 x 30 x 30 Extended Corner Work Surface	\$ 9 5 4	\$ 1 3 1 5
RECSL60962424	60 x 96 x 24 x 24 Extended Corner Work Surface	\$ 1 0 8 2	\$ 1 4 9 5
RECSL60962430	60 x 96 x 24 x 30 Extended Corner Work Surface	\$ 1 0 8 2	\$ 1 4 9 5
RECSL60963024	60 x 96 x 30 x 24 Extended Corner Work Surface	\$ 1 0 8 2	\$ 1 4 9 5
RECSL60963030	60 x 96 x 30 x 30 Extended Corner Work Surface	\$ 1 0 8 2	\$ 1 4 9 5

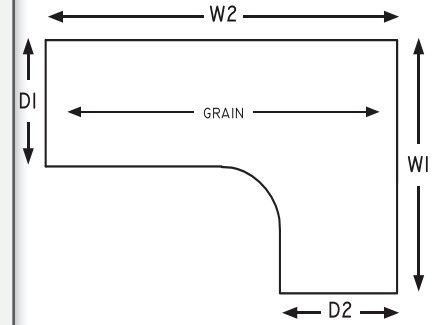

48"W=	47	1/4"W
60"W=	59	1/4"W
72"W=	71	1/4"W
84"W=	83	1/4"W
96"W=	95	1/4"W
24"D=	23	1/4"D
30"D=	29	1/4"D

To Order, Specify:

1. Model number
2. Laminate
3. Edge banding

800.763.9100
www.rework-furniture.com
furniture@rework-furniture.com

Extended Corner- Right

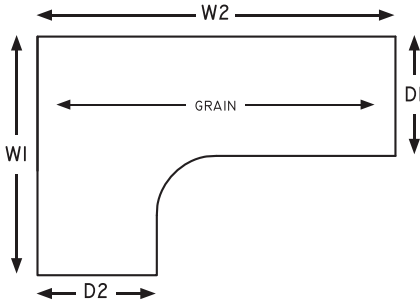

36"W=	35	1/4"W
42"W=	41	1/4"W
60"W=	59	1/4"W
72"W=	71	1/4"W
84"W=	83	1/4"W
96"W=	95	1/4"W
24"D=	23	1/4"D
30"D=	29	1/4"D

Model No.	W1 x W2 x D1 x D2	LP	HP
RECSR36602424	36 x 60 x 24 x 24 Extended Corner Work Surface	\$ 453	\$ 628
RECSR36602430	36 x 60 x 24 x 30 Extended Corner Work Surface	\$ 453	\$ 628
RECSR36603024	36 x 60 x 30 x 24 Extended Corner Work Surface	\$ 453	\$ 628
RECSR36603030	36 x 60 x 30 x 30 Extended Corner Work Surface	\$ 453	\$ 628
RECSR36722424	36 x 72 x 24 x 24 Extended Corner Work Surface	\$ 538	\$ 742
RECSR36722430	36 x 72 x 24 x 30 Extended Corner Work Surface	\$ 538	\$ 742
RECSR36723024	36 x 72 x 30 x 24 Extended Corner Work Surface	\$ 538	\$ 742
RECSR36723030	36 x 72 x 30 x 30 Extended Corner Work Surface	\$ 538	\$ 742
RECSR36842424	36 x 84 x 24 x 24 Extended Corner Work Surface	\$ 623	\$ 859
RECSR36842430	36 x 84 x 24 x 30 Extended Corner Work Surface	\$ 623	\$ 859
RECSR36843024	36 x 84 x 30 x 24 Extended Corner Work Surface	\$ 623	\$ 859
RECSR36843030	36 x 84 x 30 x 30 Extended Corner Work Surface	\$ 623	\$ 859
RECSR36962424	36 x 96 x 24 x 24 Extended Corner Work Surface	\$ 702	\$ 975
RECSR36962430	36 x 96 x 24 x 30 Extended Corner Work Surface	\$ 702	\$ 975
RECSR36963024	36 x 96 x 30 x 24 Extended Corner Work Surface	\$ 702	\$ 975
RECSR36963030	36 x 96 x 30 x 30 Extended Corner Work Surface	\$ 702	\$ 975
RECSR42602424	42 x 60 x 24 x 24 Extended Corner Work Surface	\$ 505	\$ 696
RECSR42602430	42 x 60 x 24 x 30 Extended Corner Work Surface	\$ 505	\$ 696
RECSR42603024	42 x 60 x 30 x 24 Extended Corner Work Surface	\$ 505	\$ 696
RECSR42603030	42 x 60 x 30 x 30 Extended Corner Work Surface	\$ 505	\$ 696
RECSR42722424	42 x 72 x 24 x 24 Extended Corner Work Surface	\$ 597	\$ 824
RECSR42722430	42 x 72 x 24 x 30 Extended Corner Work Surface	\$ 597	\$ 824
RECSR42723024	42 x 72 x 30 x 24 Extended Corner Work Surface	\$ 597	\$ 824
RECSR42723030	42 x 72 x 30 x 30 Extended Corner Work Surface	\$ 597	\$ 824
RECSR42842424	42 x 84 x 24 x 24 Extended Corner Work Surface	\$ 690	\$ 954
RECSR42842430	42 x 84 x 24 x 30 Extended Corner Work Surface	\$ 690	\$ 954
RECSR42843024	42 x 84 x 30 x 24 Extended Corner Work Surface	\$ 690	\$ 954
RECSR42843030	42 x 84 x 30 x 30 Extended Corner Work Surface	\$ 690	\$ 954
RECSR42962424	42 x 96 x 24 x 24 Extended Corner Work Surface	\$ 784	\$ 1082
RECSR42962430	42 x 96 x 24 x 30 Extended Corner Work Surface	\$ 784	\$ 1082
RECSR42963024	42 x 96 x 30 x 24 Extended Corner Work Surface	\$ 784	\$ 1082
RECSR42963030	42 x 96 x 30 x 30 Extended Corner Work Surface	\$ 784	\$ 1082

Extended Corner- Right

Model No.	W1 x W2 x D1 x D2	LP	HP
RECSR48602424	48 x 60 x 24 x 24 Extended Corner Work Surface	\$ 5 6 9	\$ 7 8 3
RECSR48602430	48 x 60 x 24 x 30 Extended Corner Work Surface	\$ 5 6 9	\$ 7 8 3
RECSR48603024	48 x 60 x 30 x 24 Extended Corner Work Surface	\$ 5 6 9	\$ 7 8 3
RECSR48603030	48 x 60 x 30 x 30 Extended Corner Work Surface	\$ 5 6 9	\$ 7 8 3
RECSR48722424	48 x 72 x 24 x 24 Extended Corner Work Surface	\$ 6 7 1	\$ 9 3 0
RECSR48722430	48 x 72 x 24 x 30 Extended Corner Work Surface	\$ 6 7 1	\$ 9 3 0
RECSR48723024	48 x 72 x 30 x 24 Extended Corner Work Surface	\$ 6 7 1	\$ 9 3 0
RECSR48723030	48 x 72 x 30 x 30 Extended Corner Work Surface	\$ 6 7 1	\$ 9 3 0
RECSR48842424	48 x 84 x 24 x 24 Extended Corner Work Surface	\$ 7 7 9	\$ 1 0 7 5
RECSR48842430	48 x 84 x 24 x 30 Extended Corner Work Surface	\$ 7 7 9	\$ 1 0 7 5
RECSR48843024	48 x 84 x 30 x 24 Extended Corner Work Surface	\$ 7 7 9	\$ 1 0 7 5
RECSR48843030	48 x 84 x 30 x 30 Extended Corner Work Surface	\$ 7 7 9	\$ 1 0 7 5
RECSR48962424	48 x 96 x 24 x 24 Extended Corner Work Surface	\$ 8 8 3	\$ 1 2 2 1
RECSR48962430	48 x 96 x 24 x 30 Extended Corner Work Surface	\$ 8 8 3	\$ 1 2 2 1
RECSR48963024	48 x 96 x 30 x 24 Extended Corner Work Surface	\$ 8 8 3	\$ 1 2 2 1
RECSR48963030	48 x 96 x 30 x 30 Extended Corner Work Surface	\$ 8 8 3	\$ 1 2 2 1
RECSR60602424	60 x 60 x 24 x 24 Extended Corner Work Surface	\$ 6 9 8	\$ 9 6 4
RECSR60602430	60 x 60 x 24 x 30 Extended Corner Work Surface	\$ 6 9 8	\$ 9 6 4
RECSR60603024	60 x 60 x 30 x 24 Extended Corner Work Surface	\$ 6 9 8	\$ 9 6 4
RECSR60603030	60 x 60 x 30 x 30 Extended Corner Work Surface	\$ 6 9 8	\$ 9 6 4
RECSR60722424	60 x 72 x 24 x 24 Extended Corner Work Surface	\$ 8 2 8	\$ 1 1 4 1
RECSR60722430	60 x 72 x 24 x 30 Extended Corner Work Surface	\$ 8 2 8	\$ 1 1 4 1
RECSR60723024	60 x 72 x 30 x 24 Extended Corner Work Surface	\$ 8 2 8	\$ 1 1 4 1
RECSR60723030	60 x 72 x 30 x 30 Extended Corner Work Surface	\$ 8 2 8	\$ 1 1 4 1
RECSR60842424	60 x 84 x 24 x 24 Extended Corner Work Surface	\$ 9 5 4	\$ 1 3 1 5
RECSR60842430	60 x 84 x 24 x 30 Extended Corner Work Surface	\$ 9 5 4	\$ 1 3 1 5
RECSR60843024	60 x 84 x 30 x 24 Extended Corner Work Surface	\$ 9 5 4	\$ 1 3 1 5
RECSR60843030	60 x 84 x 30 x 30 Extended Corner Work Surface	\$ 9 5 4	\$ 1 3 1 5
RECSR60962424	60 x 96 x 24 x 24 Extended Corner Work Surface	\$ 1 0 8 2	\$ 1 4 9 5
RECSR60962430	60 x 96 x 24 x 30 Extended Corner Work Surface	\$ 1 0 8 2	\$ 1 4 9 5
RECSR60963024	60 x 96 x 30 x 24 Extended Corner Work Surface	\$ 1 0 8 2	\$ 1 4 9 5
RECSR60963030	60 x 96 x 30 x 30 Extended Corner Work Surface	\$ 1 0 8 2	\$ 1 4 9 5

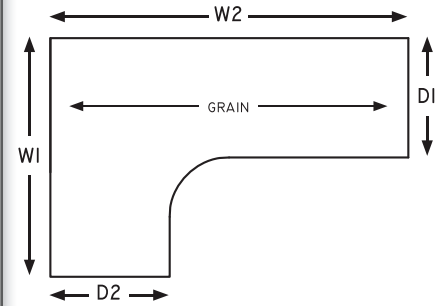

- 48"W= 47 1/4"W
- 60"W= 59 1/4"W
- 72"W= 71 1/4"W
- 84"W= 83 1/4"W
- 96"W= 95 1/4"W
- 24"D= 23 1/4"D
- 30"D= 29 1/4"D

To Order, Specify:
 1. Model number
 2. Laminate
 3. Edge banding

800.763.9100
www.rework-furniture.com
furniture@rework-furniture.com

Anti-sag Bars

Model No.	Description	List
R6052	52" Anti-sag bar	\$118

Grommet

Model No.	Description	List
RWG	3" Factory-installed Grommet, Black	\$48
RG	3" Grommet Sleeve + Cover, Black	\$30

Scallop

Model No.	Description	List
RWS	Scallop- single	\$45

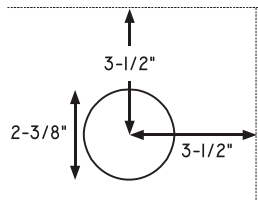
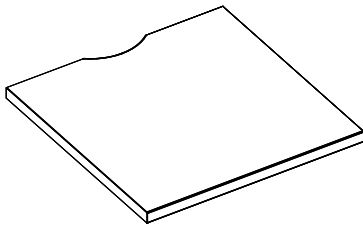
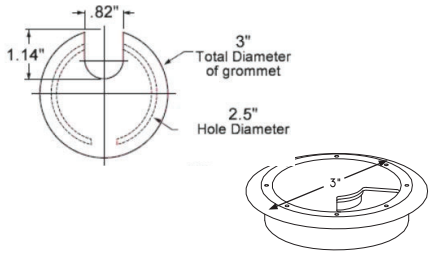

Grommet Location

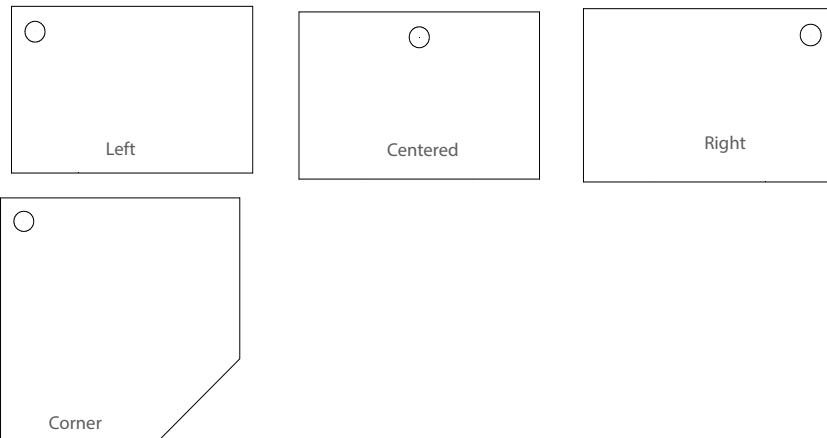

Scallop Location

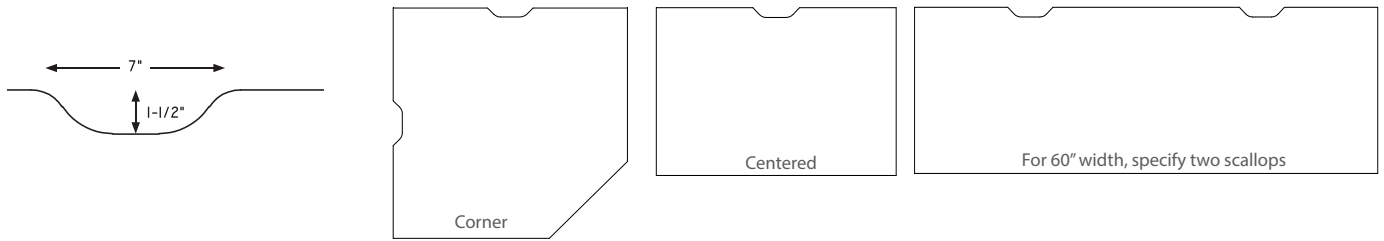

To Order, Specify:
 1. Model number
 2. Location
 3. Drawing required for custom locations

800.763.9100
 www.rework-furniture.com
 furniture@rework-furniture.com

Cantilever Bracket

Model No.	Description	List
RCLH	Left Handed Cantilever, 16 1/2"D	\$46
RCRH	Right Handed Cantilever, 16 1/2"D	\$46
*Note: Cantilevers Painted Black		

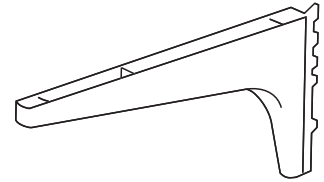

Side Bracket

Model No.	Description	List
RSBLH	Left Handed Side Bracket	\$14
RSBRH	Right Handed Side Bracket	\$14

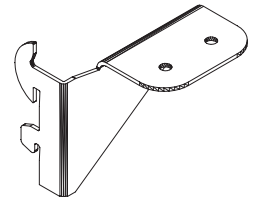

Flush Mount Plate

Model No.	Description	List
RFMP	Flush Mount Plate, 3"D x 4"W	\$27

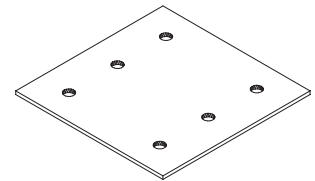

Tie Plate

Model No.	Description	List
RTP	Tie Plate, 3/4"D x 2 3/4"W	\$6

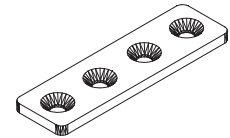

Rear Corner Bracket

Model No.	Description	List
RCB	Rear Corner Bracket	\$27

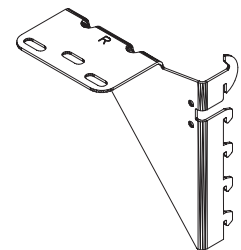

Transaction Top Brackets

Model No.	Description	List
RTTB	Transaction Top Bracket- pair	\$78
Two pairs of transaction top brackets are required for all transaction tops up to 60"W. For larger sizes, please inquire.		

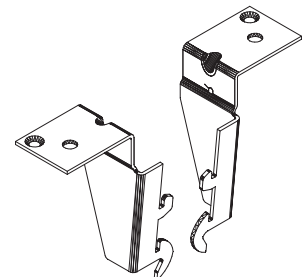

To Order, Specify:
1. Model number
2. Paint

800.763.9100
www.rework-furniture.com
furniture@rework-furniture.com

Support Panels- Laminate

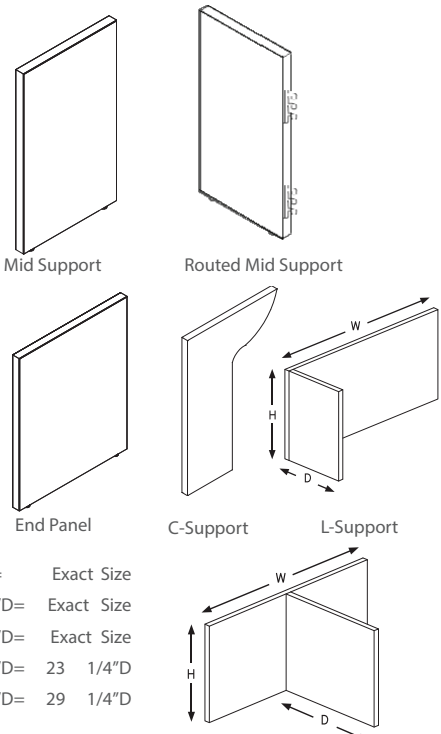

W= Exact Size
 12"D= Exact Size
 18"D= Exact Size
 24"D= 23 1/4"D
 30"D= 29 1/4"D

Model No.	Description	LP	HP
RLC18SUP	C-Support, 18"D x 27"H	\$ 209	\$ 297
RLL18SUP	L-Support, 18"D x 24"W x 27"H	\$ 360	\$ 512
RLT24SUP	T-Support, 18"D x 24"W x 27"H	\$ 360	\$ 515
RLT30SUP	T-Support, 18"D x 30"W x 27"H	\$ 408	\$ 580
RLT36SUP	T-Support, 18"D x 36"W x 27"H	\$ 447	\$ 648
RL12MS	Mid Support, 12"D x 27"H	\$ 138	\$ 193
RL18MS	Mid Support, 18"D x 27"H	\$ 176	\$ 249
RLL12MS	Routed Mid Support Left, 12"D x 27"H	\$ 204	\$ 260
RLR12MS	Routed Mid Support Right, 12"D x 27"H	\$ 204	\$ 260
RLL18MS	Routed Mid Support Left, 18"D x 27"H	\$ 242	\$ 315
RLR18MS	Routed Mid Support Right, 18"D x 27"H	\$ 242	\$ 315
RL24END	End Panel, 24"D x 27"H	\$ 199	\$ 286
RL30END	End Panel, 30"D x 27"H	\$ 238	\$ 342
RLL24END	Routed End Panel Left 24"D x 27"H	\$ 272	\$ 358
RLR24END	Routed End Panel Right 24"D x 27"H	\$ 272	\$ 358
RLL30END	Routed End Panel Left 30"D x 27"H	\$ 310	\$ 412
RLR30END	Routed End Panel Right 30"D x 27"H	\$ 310	\$ 412

Modesty Panels

Model No.	Description	LP	HP
RMP1224	12"H x 24"W Modesty Panel	\$ 109	\$ 153
RMP1236	12"H x 36"W Modesty Panel	\$ 124	\$ 176
RMP1242	12"H x 42"W Modesty Panel	\$ 132	\$ 189
RMP1248	12"H x 48"W Modesty Panel	\$ 140	\$ 197
RMP1254	12"H x 54"W Modesty Panel	\$ 153	\$ 212
RMP2724	27"H x 24"W Modesty Panel	\$ 240	\$ 343
RMP2736	27"H x 36"W Modesty Panel	\$ 275	\$ 393
RMP2742	27"H x 42"W Modesty Panel	\$ 297	\$ 425
RMP2748	27"H x 48"W Modesty Panel	\$ 310	\$ 440
RMP2754	27"H x 54"W Modesty Panel	\$ 335	\$ 475

Gusset Bracket

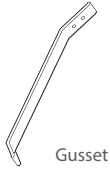

Gusset

Model No.	Description	List
RGB	Gusset Bracket	\$20

Column Leg

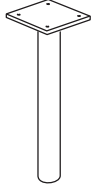

Column Leg

Model No.	Description	List
RCL	Column Leg, 27"H	\$195

To Order Laminate Support Panels, Specify:
 1. Model number
 2. Laminate

To Order Painted Support Panels, Gusset Bracket + Column Leg, Specify:
 1. Model number
 2. Paint

800.763.9100
www.rework-furniture.com
furniture@rework-furniture.com

Low/Mid Shelf

Model No.	Description	List
RLS24	24"W Low Shelf	\$176
RLS30	30"W Low Shelf	\$182
RLS36	36"W Low Shelf	\$189
RLS48	48"W Low Shelf	\$195
RLS60	60"W Low Shelf	\$214

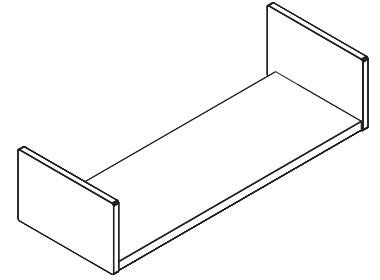

Regular/Full Shelf

Model No.	Description	List
RRS24	24"W Regular Shelf	\$176
RRS30	30"W Regular Shelf	\$182
RRS36	36"W Regular Shelf	\$189
RRS48	48"W Regular Shelf	\$195
RRS60	60"W Regular Shelf	\$214

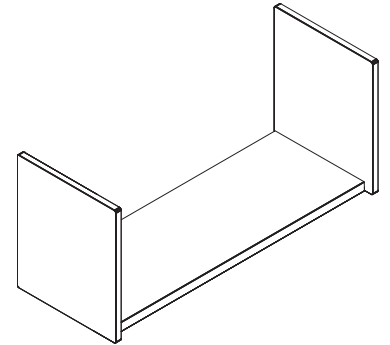

Fabric Front Overhead Unit

Model No.	Description	List
ROHF24	24"W Fabric Overhead Unit	\$525
ROHF30	30"W Fabric Overhead Unit	\$454
ROHF36	36"W Fabric Overhead Unit	\$564
ROHF48	48"W Fabric Overhead Unit	\$622
ROHF60	60"W Fabric Overhead Unit	\$726

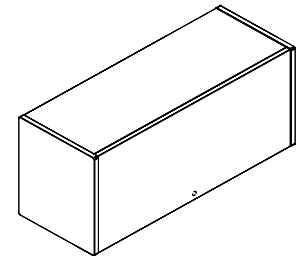

Task Lights

Model No.	Description	List
RTL30	30"W Task Light	\$195

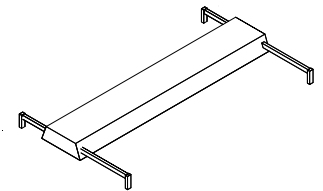

Refurbished Top Supporting Pedestal

Model No.	Description	List
R B B F 2 4 T S	Refurbished Box/Box/File Pedestal, 23"D x 15 3/8"W x 27 7/8"H	\$519
R F F 2 4 T S	Refurbished File/File Pedestal, 23"D x 15 3/8"W x 27 7/8"H	\$519

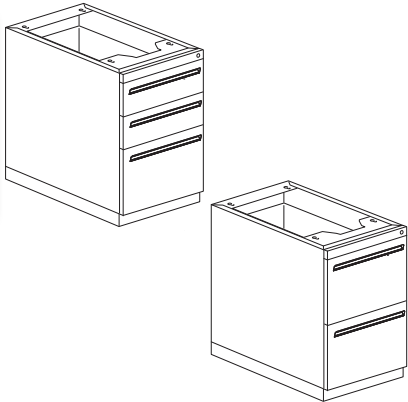

Metal top not included on top supporting files.

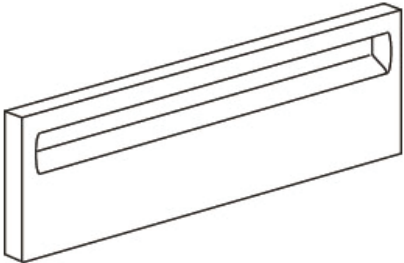

The pull for a refurbished drawer pedestal is continuous as shown.

Core + Key

Model No.	Description	List
R E S L C	Core + Key	\$ 3 3
R E S K	Key Only	\$ 2 0
R E S M K	Master Key	\$ 1 6 2
R E S C P	Core Puller	\$ 1 6 2

Please refer to page 32 for detailed information on keying work stations alike.

To Order, Specify:
1. Model number
2. Paint

ALL METAL REFURBISHED LOWER STORAGE IS REPAINTED ONLY.
EXISTING GANGING HOLES, MINOR SCRATCHES AND/OR DENTS MAY BE VISIBLE.

800.763.9100
www.rework-furniture.com
furniture@rework-furniture.com

Panel Mounted Tackboard

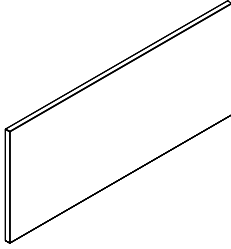

Model No.	Description	List
RPTB2416	24"W x 16"H Panel Mounted Tackboard	\$ 143
RPTB3016	30"W x 16"H Panel Mounted Tackboard	\$ 149
RPTB3616	36"W x 16"H Panel Mounted Tackboard	\$ 156
RPTB4816	48"W x 16"H Panel Mounted Tackboard	\$ 168
RPTB6016	60"W x 16"H Panel Mounted Tackboard	\$ 221
RPTB7216	72"W x 16"H Panel Mounted Tackboard	\$ 260

Tackboard Thickness 1".

Wall Mounted Tackboard

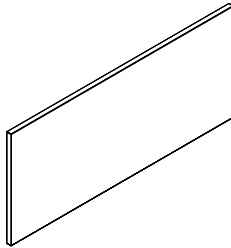

Model No.	Description	List
RWTB2416	24"W x 16"H Wall-Mounted Tackboard Includes (4) Z-Clips	\$ 221
RWTB3016	30"W x 16"H Wall-Mounted Tackboard Includes (4) Z-Clips	\$ 227
RWTB3616	36"W x 16"H Wall-Mounted Tackboard Includes (4) Z-Clips	\$ 233
RWTB4816	48"W x 16"H Wall-Mounted Tackboard Includes (4) Z-Clips	\$ 246
RWTB6016	60"W x 16"H Wall-Mounted Tackboard Includes (4) Z-Clips	\$ 298
RWTB7216	72"W x 16"H Wall-Mounted Tackboard Includes (6) Z-Clips	\$ 376
RWTB2420	24"W x 20"H Wall-Mounted Tackboard Includes (4) Z-Clips	\$ 227
RWTB3020	30"W x 20"H Wall-Mounted Tackboard Includes (4) Z-Clips	\$ 233
RWTB3620	36"W x 20"H Wall-Mounted Tackboard Includes (4) Z-Clips	\$ 246
RWTB4820	48"W x 20"H Wall-Mounted Tackboard Includes (4) Z-Clips	\$ 338
RWTB6020	60"W x 20"H Wall-Mounted Tackboard Includes (4) Z-Clips	\$ 376
RWTB7220	72"W x 20"H Wall-Mounted Tackboard Includes (6) Z-Clips	\$ 416
RWTB4848	48"W x 48"H Wall-Mounted Tackboard Includes (6) Z-Clips	\$ 675
RWTB6048	60"W x 48"H Wall-Mounted Tackboard Includes (6) Z-Clips	\$ 752
RWTB7248	72"W x 48"H Wall-Mounted Tackboard Includes (8) Z-Clips	\$ 830

Tackboard Thickness 1".

To Order Tackboard, Specify:

1. Model number
2. Fabric pattern/colorway
3. Fabric direction

To Order Cores + Keys, Specify:

1. Model number
2. Specific key number if required

800.763.9100
www.rework-furniture.com
furniture@rework-furniture.com



Sparkle

Alloy

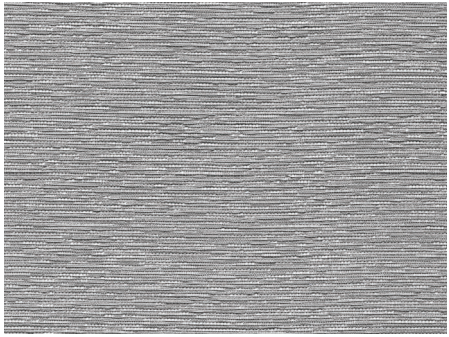

Sparkle

Chrome

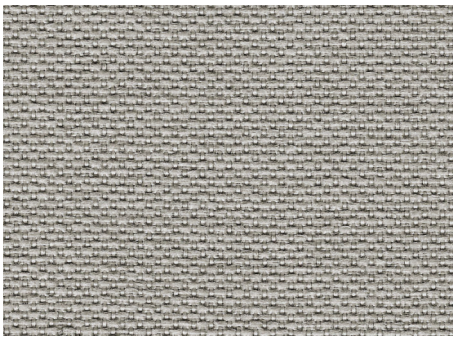

Reflect

Moondust

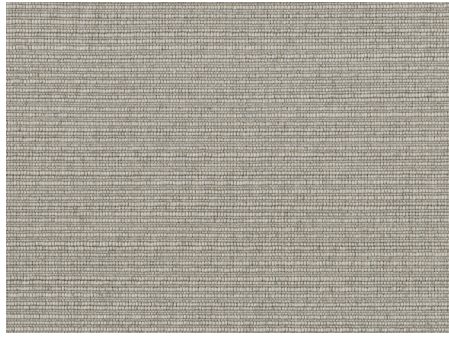

Parada

Slate

Sparkle

Content:	100% Polyester
Width:	66" +/-2%
Direction:	Rightway
Abrasion Resistance (ASTM 4966-98):	Over 30,000 Rubs Martindale 12kpa
Colorfastness to Crocking (AATCC 8-2007):	Dry: 4.5 Wet: 4.5
Colorfastness to Light (AATCC 16-2004):	Hours: 40.0 Class: 4.0
Tensile Strength (ASTM D5034-2009):	Warp: 254.60 lbs Fill: 281.50 lbs
Seam Slippage (ASTM D434-1995):	Warp: 54.50 lbs Fill: 69.10 lbs
Flammability	
CAL TB 117-E:	Passes
ASTM E-84:	Class 1

Reflect

Content:	100% Polyester
Width:	66" +/-2%
Direction:	Non-Directional
Abrasion Resistance (ASTM 4966-12"):)	Over 30,000 Rubs Martindale 12kpa
Colorfastness to Crocking (AATCC 8-2007):	Dry: 4.5 Wet: 4.5
Colorfastness to Light (AATCC 16.3-2012):	Hours: 40.0 Class: 4.0
Tensile Strength (ASTM D5034-2009 (2013)):	Warp: 314.3 lbs Fill: 256.8 lbs
Seam Slippage (ASTM D434-1995):	Warp: 51.50 lbs Fill: 51.80 lbs
Flammability	
CAL TB 117-E:	Passes
ASTM E-84:	Class 1

Parada

Content:	100% Polyester
Width:	66" +/-2%
Direction:	Rightway
Abrasion Resistance (ASTM 4966-12"):	Over 30,000 Rubs Martindale 12kpa
Colorfastness to Crocking (AATCC 8-2007):	Dry: 4.5 Wet: 4.5
Colorfastness to Light (AATCC 16.3-2012):	Hours: 40.0 Class: 3.5
Tensile Strength (ASTM D5034-2009 (2013)):	Warp: 251.7 lbs Fill: 336.2 lbs
Seam Slippage (ASTM D434-1992):	Warp: 36.7 lbs Fill: 75.2 lbs
Flammability	
CAL TB 117-E:	Passes
ASTM E-84:	Class 1

Fabric application as shown
Non-Directional: Reflect
Directional Rightway: Parada and Sparkle



Willow

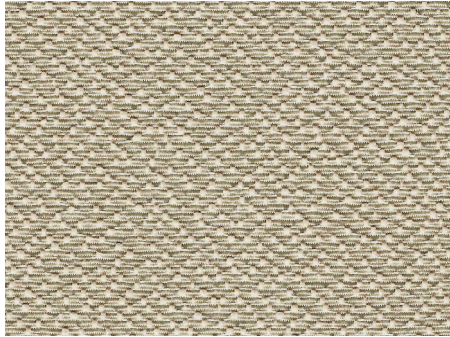

Dusk

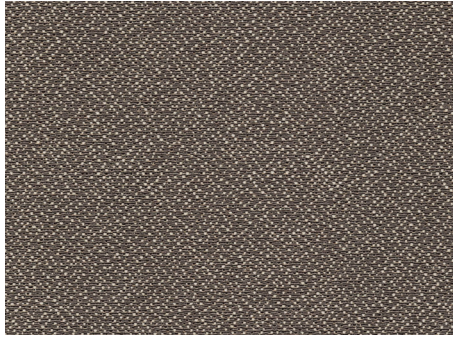

Glamour

Glamour

Froth

Buff



Simplicity

Spun

Silver



Sparkle

Rust



Prada

Sandstone



Simplicity

Fawn

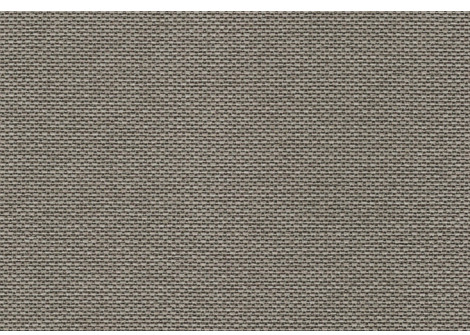

Reflect

Sandy

Shore

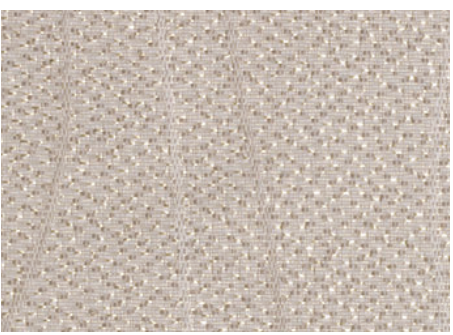

Willow

Hazy

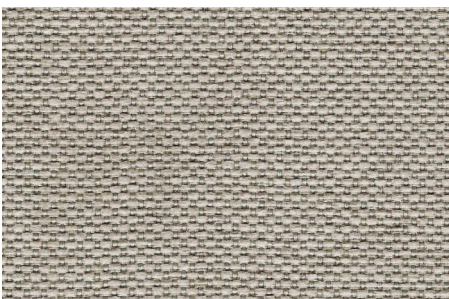

Reflect

Champagne

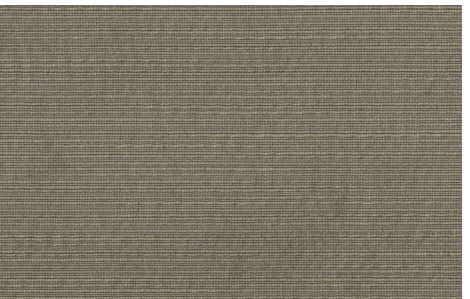

Parada

Adobe

Fabric application as shown
 Non-Directional: Reflect, Simplicity and Glamour
 Directional Rightway: Parada and Sparkle
 Directional Railroad: Willow

*NOTE: Quantities Subject To Availability.



White



Gray Tone



Graphite



Silver

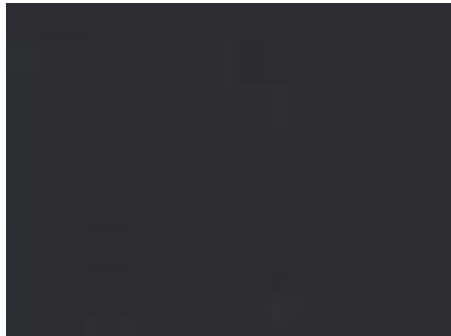

Black

A 10% Upcharge Applies To
-Custom Paint Match



White



Black

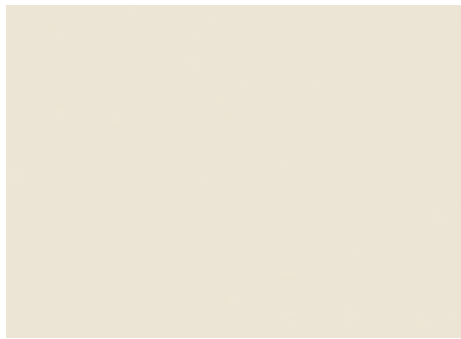

Willow

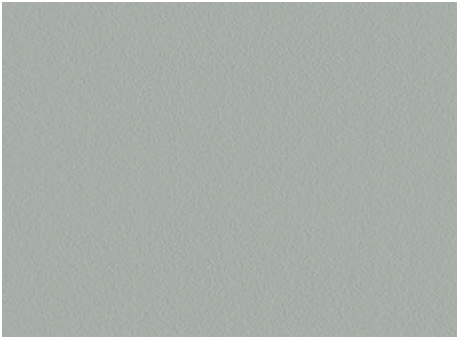

Fog Grey

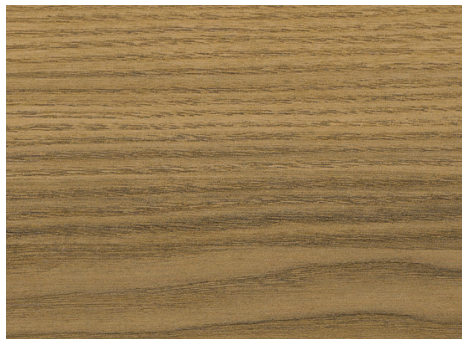

Karruna Ash



Chique



Pewter Pine

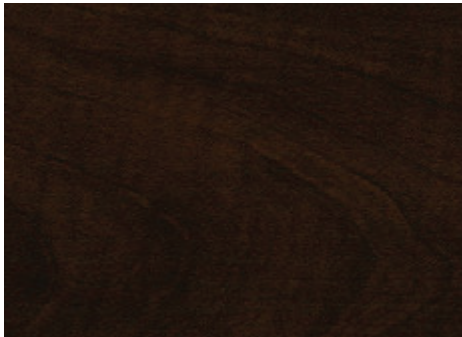

Sable Glow

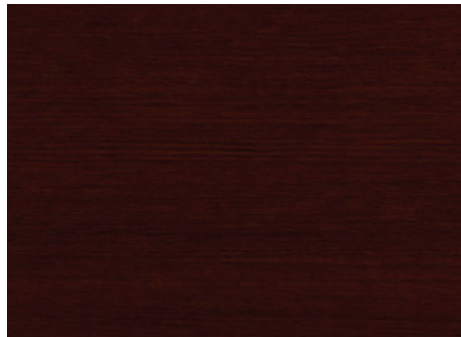

Brazilian Walnut

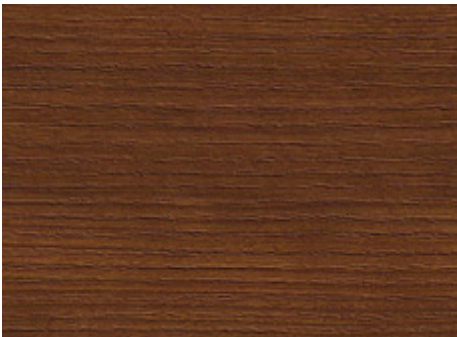

Ankara Cherry

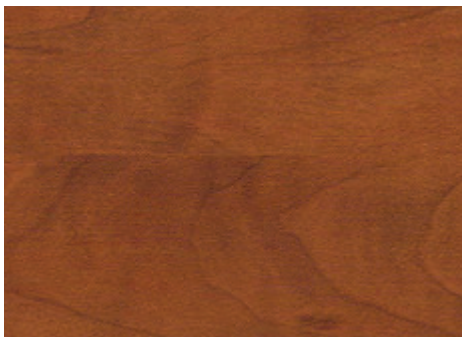

Autumn Glow

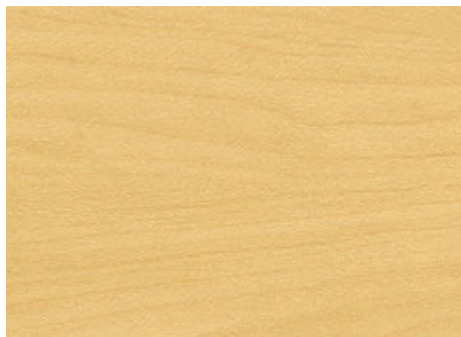

Cabinet Maple

--Please refer to the Wilsonart contract standards for high pressure laminate selection.
An upcharge will be applied for all premium and HD premium colors.



White



Black

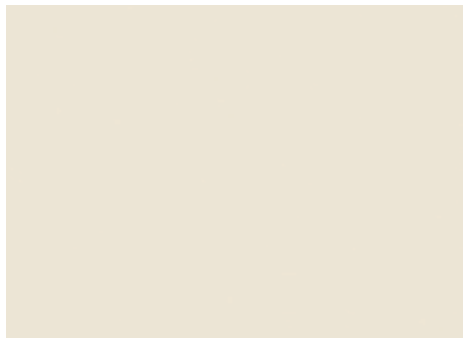

Willow

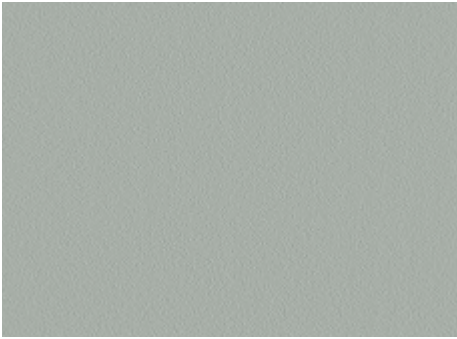

Fog Grey

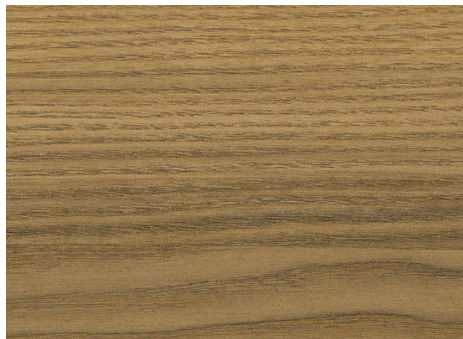

Karruna Ash



Chique

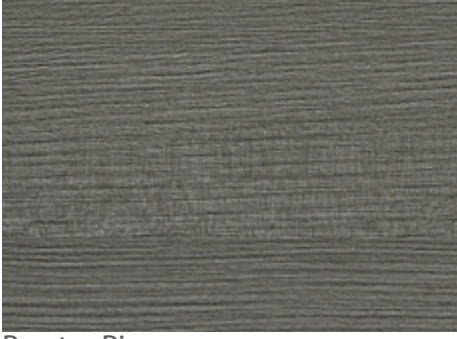

Pewter Pine

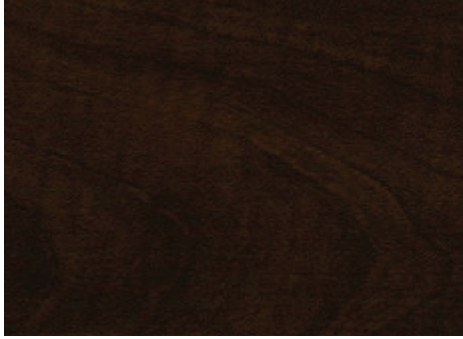

Sable Glow

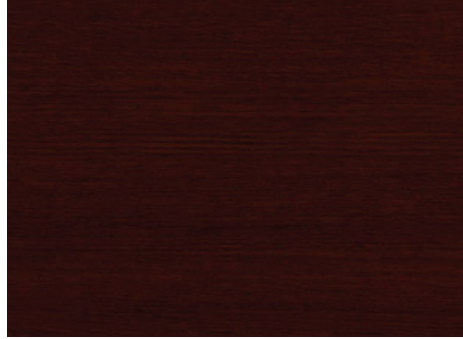

Brazilian Walnut

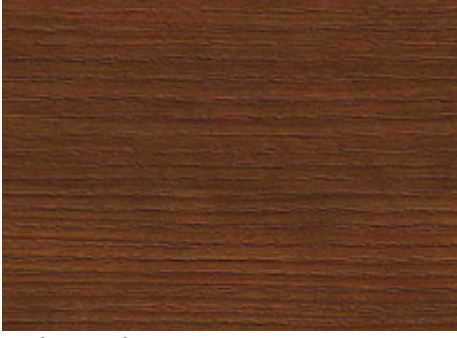

Ankara Cherry



Autumn Glow



Cabinet Maple

Due to variations in the configuration, setting, and collaboration of technical devices, the digital image color shown here may vary from actual samples.

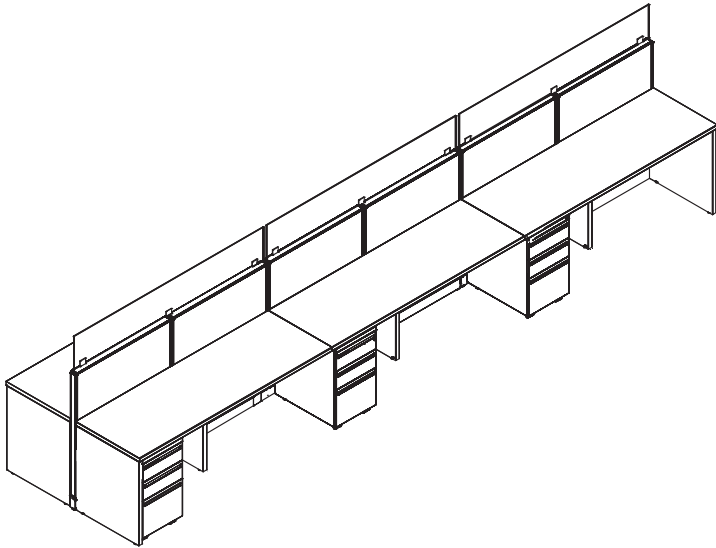

2' x 6' Benching Workstation

44"H Panels with 9"H Frameless Frosted Plexiglass
National Code Power, (2) Duplex Receptacles per unit,
Low Pressure Surfaces + Refurbished Pedestals
\$2,968 per station list
*List price based on six pack configuration

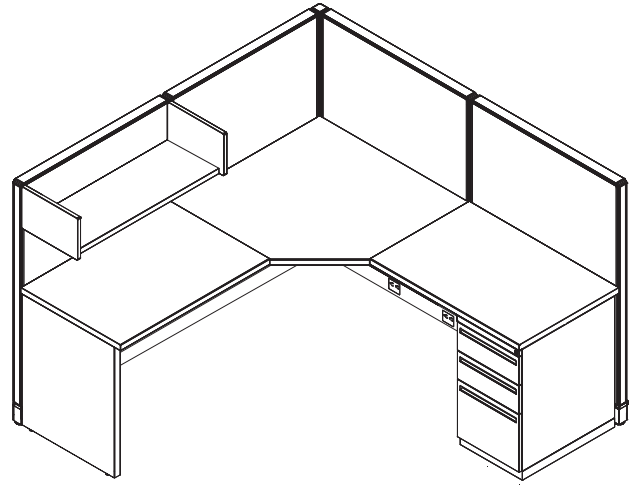

6' x 6'

50"H Panels
National Code Power, (2) Duplex Receptacles per unit,
Low Pressure Surfaces + Refurbished Pedestals
\$4,638 per station list
*List price based on four pack configuration

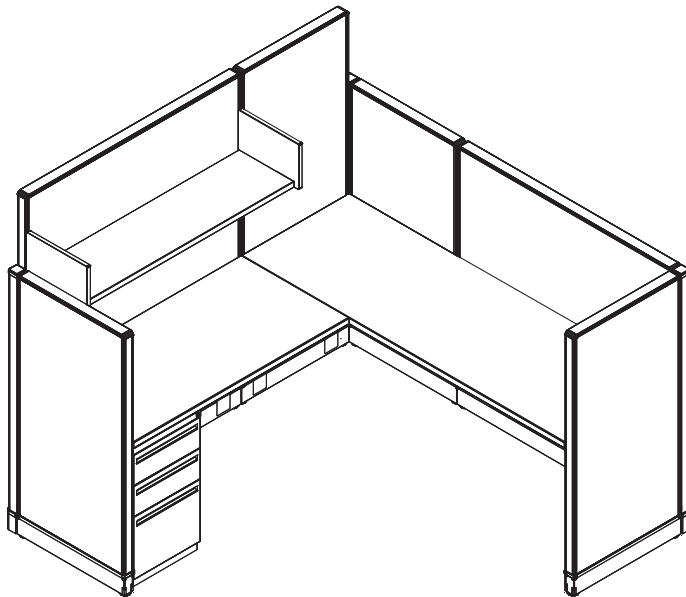

6' x 6'

50/64"H Panels
National Code Power, (2) Duplex Receptacles per unit,
Low Pressure Surfaces + Refurbished Pedestals
\$5,272 per station list
*List price based on four pack configuration

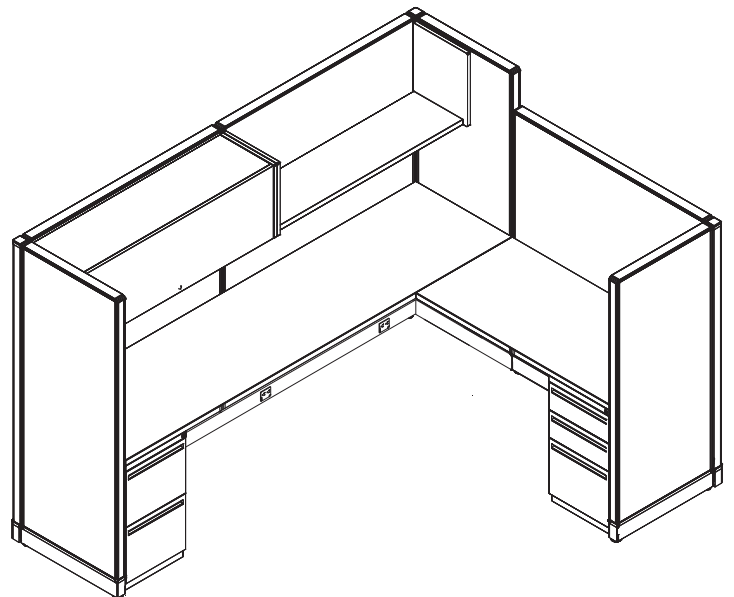

6' x 8'

56/64"H Panels
National Code Power, (2) Duplex Receptacles per unit,
Low Pressure Surfaces + Refurbished Pedestals
\$6,350 per station list
*List price based on four pack configuration

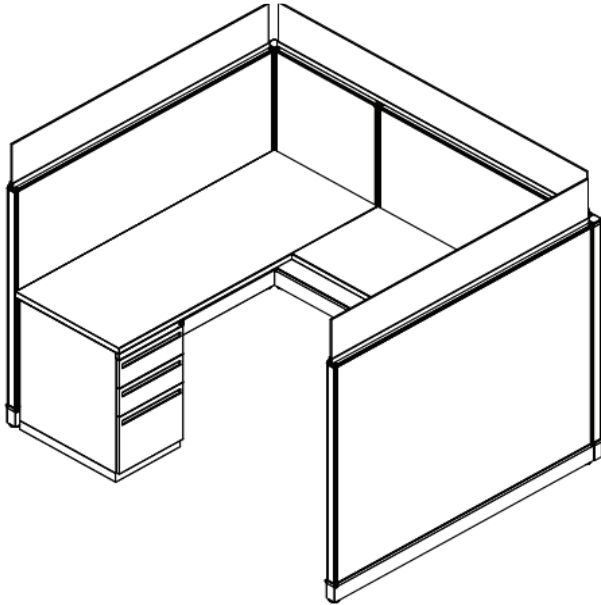

5' x 6'

50"H Panels

National Code Power, (2) Duplex Receptacles per unit,

Low Pressure Surfaces + Refurbished Pedestals

\$5,490 per station list

*List price based on six pack configuration

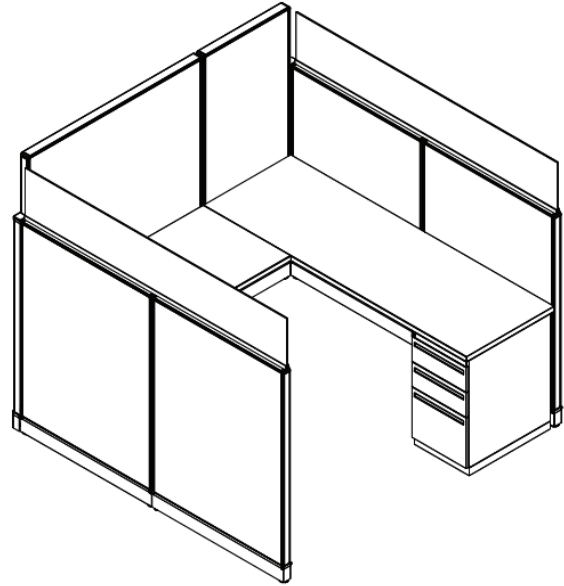

6' x 6'

50/64"H Panels

National Code Power, (2) Duplex Receptacles per unit,

Low Pressure Surfaces + Refurbished Pedestals

\$6,078 per station list

*List price based on six pack configuration

To confirm approval of or request new approval for COM, contact furniture@reworkbyroe.com.

If the fabric is approved, and the directional orientation (directional rightway, directional railroad, or non-directional) of the tested fabric has been confirmed, then refer to the appropriate column in the chart for yardage requirements.

Steps to follow to calculate fabric usage:

- 1) Identify product type and size.
- 2) Determine method in which fabric is to be cut (directional rightway, directional railroad or non-directional).
- 3) Determine fabric roll width.
- 4) Find corresponding fabric usage value from the table.
- 5) Calculate fabric required using the formula below:

$$\text{Fabric usage} = \text{number of units} \times \text{number of sides with fabric} \times \text{fabric usage from tables.}$$
- 6) Repeat steps 1-5 for each product type, size and fabric.
- 7) Add all values together to find total number of linear yards required for the order. Add the appropriate percentage shown below to the total yardage to accommodate fabric flaws, wrinkles and other imperfections.

Up to 500 yards Add 10%

501 to 1000 yards Add 5%

More than 1000 yards Add 3%

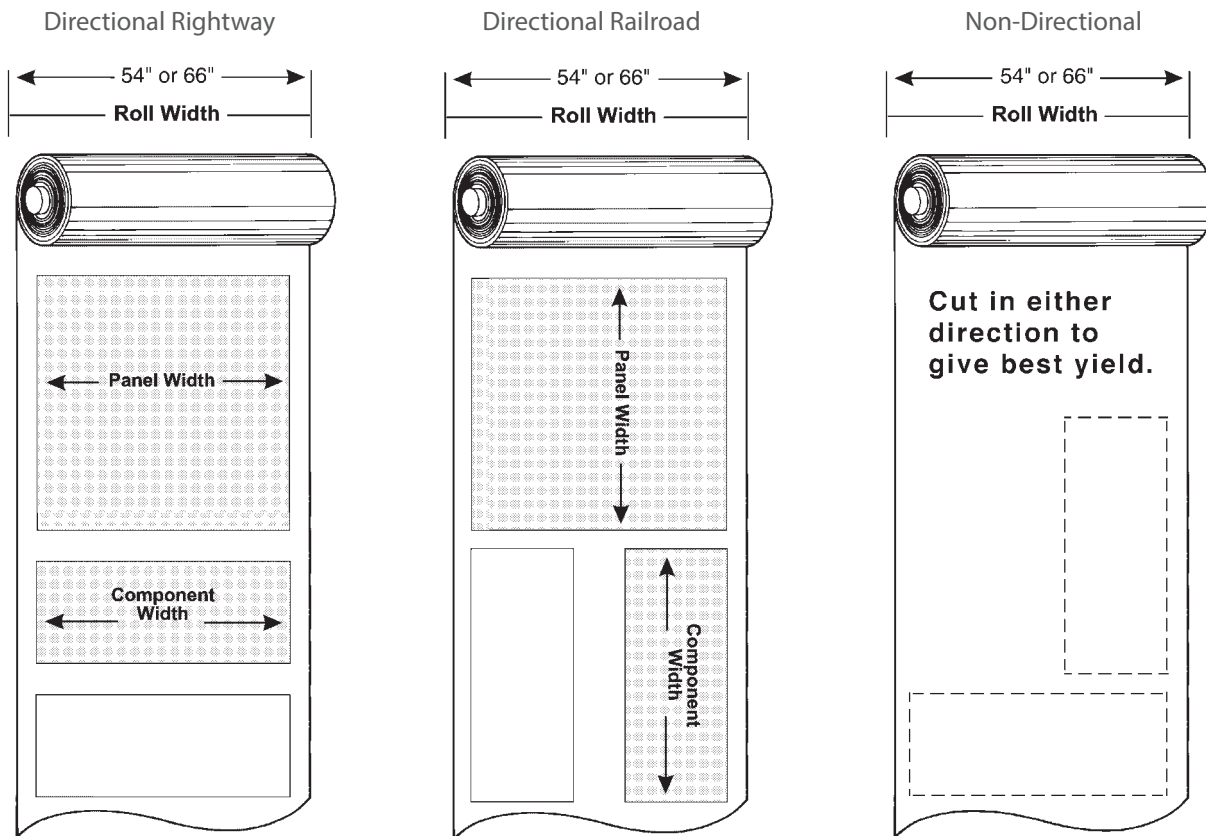

Actual (Inches) Height	Width	54 Inch Roll (Linear Yard)			66 Inch Roll (Linear Yard)		
		Directional Rightway	Directional Railroad	Non-Directional	Directional Rightway	Directional Railroad	Non-Directional
Panel							
30 (762mm)	12 (305mm)	0.28	0.44	0.28	0.21	0.22	0.21
	18 (457mm)	0.42	0.61	0.42	0.28	0.31	0.28
	24 (610mm)	0.42	0.78	0.42	0.42	0.39	0.39
	30 (762mm)	0.83	0.94	0.83	0.42	0.47	0.42
	36 (914mm)	0.83	1.11	0.83	0.83	0.56	0.56
	42 (1067mm)	0.83	1.28	0.83	0.83	0.64	0.64
	48 (1219mm)	0.83	1.44	0.83	0.83	0.72	0.72
	54 (1371mm)	N/A	1.61	1.61	0.83	0.81	0.81
	60 (1529mm)	N/A	1.78	1.78	0.83	0.89	0.83
37 (940mm)	12 (305mm)	0.34	0.44	0.34	0.26	0.44	0.26
	18 (457mm)	0.51	0.61	0.51	0.34	0.61	0.34
	24 (610mm)	0.51	0.78	0.51	0.51	0.78	0.51
	30 (762mm)	1.03	0.94	0.94	0.51	0.94	0.51
	36 (914mm)	1.03	1.11	1.03	1.03	1.11	1.03
	42 (1067mm)	1.03	1.28	1.03	1.03	1.28	1.03
	48 (1219mm)	1.03	1.44	1.03	1.03	1.44	1.03
	54 (1371mm)	N/A	1.61	1.61	1.03	1.61	1.03
	60 (1529mm)	N/A	1.78	1.78	1.03	1.78	1.03
44 (1118mm)	12 (305mm)	0.41	0.44	0.41	0.31	0.44	0.31
	18 (457mm)	0.61	0.61	0.61	0.41	0.61	0.41
	24 (610mm)	0.61	0.78	0.61	0.61	0.78	0.61
	30 (762mm)	1.22	0.94	0.94	0.61	0.94	0.61
	36 (914mm)	1.22	1.11	1.11	1.22	1.11	1.11
	42 (1067mm)	1.22	1.28	1.22	1.22	1.28	1.22
	48 (1219mm)	1.22	1.44	1.22	1.22	1.44	1.22
	54 (1371mm)	N/A	1.61	1.61	1.22	1.61	1.22
	60 (1529mm)	N/A	1.78	1.78	1.22	1.78	1.22
50 (1270mm)	12 (305mm)	0.46	0.44	0.44	0.35	0.44	0.35
	18 (457mm)	0.69	0.61	0.61	0.46	0.61	0.46
	24 (610mm)	0.69	0.78	0.69	0.69	0.78	0.69
	30 (762mm)	1.39	0.94	0.94	0.69	0.94	0.69
	36 (914mm)	1.39	1.11	1.11	1.39	1.11	1.11
	42 (1067mm)	1.39	1.28	1.28	1.39	1.28	1.28
	48 (1219mm)	1.39	1.44	1.39	1.39	1.44	1.39
	54 (1371mm)	N/A	1.61	1.61	1.39	1.61	1.39
	60 (1529mm)	N/A	1.78	1.78	1.39	1.78	1.39
56 (1422mm)	12 (305mm)	0.52	0.44	0.44	0.39	0.44	0.39
	18 (457mm)	0.78	0.61	0.61	0.52	0.61	0.52
	24 (610mm)	0.78	0.78	0.78	0.78	0.78	0.78
	30 (762mm)	1.56	0.94	0.94	0.78	0.94	0.78
	36 (914mm)	1.56	1.11	1.11	1.56	1.11	1.11
	42 (1067mm)	1.56	1.28	1.28	1.56	1.28	1.28
	48 (1219mm)	1.56	1.44	1.44	1.56	1.44	1.44
	54 (1371mm)	N/A	1.61	1.61	1.56	1.67	1.56
	60 (1529mm)	N/A	1.78	1.78	1.56	1.78	1.56
64 (1626mm)	12 (305mm)	0.59	N/A	0.59	0.44	0.44	0.44
	18 (457mm)	0.89	N/A	0.89	0.59	0.61	0.59
	24 (610mm)	0.89	N/A	0.89	0.89	0.78	0.78
	30 (762mm)	1.78	N/A	1.78	0.89	0.94	0.89
	36 (914mm)	1.78	N/A	1.78	1.78	1.11	1.11
	42 (1067mm)	1.78	N/A	1.78	1.78	1.28	1.28
	48 (1219mm)	1.78	N/A	1.78	1.78	1.44	1.44
	54 (1371mm)	N/A	N/A	N/A	1.78	1.61	1.61
	60 (1529mm)	N/A	N/A	N/A	1.78	1.78	1.78

Actual (Inches) Height	Width	54 Inch Roll (Linear Yard)			66 Inch Roll (Linear Yard)		
		Directional Rightway	Directional Railroad	Non-Directional	Directional Rightway	Directional Railroad	Non-Directional
68 (1727mm)	12 (305mm)	0.63	N/A	0.63	0.47	0.44	0.44
	18 (457mm)	0.94	N/A	0.94	0.63	0.61	0.61
	24 (610mm)	0.94	N/A	0.94	0.94	0.78	0.78
	30 (762mm)	1.89	N/A	1.89	0.94	0.94	0.94
	36 (914mm)	1.89	N/A	1.89	1.89	1.11	1.11
	42 (1067mm)	1.89	N/A	1.89	1.89	1.28	1.28
	48 (1219mm)	1.89	N/A	1.89	1.89	1.44	1.44
	54 (1371mm)	N/A	N/A	N/A	1.89	1.61	1.61
	60 (1529mm)	N/A	N/A	N/A	1.89	1.78	1.78
82 (2083mm)	12 (305mm)	0.76	N/A	0.76	0.57	N/A	0.57
	18 (457mm)	1.14	N/A	1.14	0.76	N/A	0.76
	24 (610mm)	1.14	N/A	1.14	1.14	N/A	1.14
	30 (762mm)	2.28	N/A	2.28	1.14	N/A	1.14
	36 (914mm)	2.28	N/A	2.28	2.28	N/A	2.28
	42 (1067mm)	2.28	N/A	2.28	2.28	N/A	2.28
	48 (1219mm)	2.28	N/A	2.28	2.28	N/A	2.28
	54 (1371mm)	N/A	N/A	N/A	2.28	N/A	2.28
	60 (1529mm)	N/A	N/A	N/A	2.28	N/A	2.28

Actual (Inches) Height	Width	54 Inch Roll (Linear Yard)			66 Inch Roll (Linear Yard)		
		Directional Rightway	Directional Railroad	Non-Directional	Directional Rightway	Directional Railroad	Non-Directional
Tackboard							
16" (406mm)	24 (610mm)	0.61	0.42	0.42	0.61	0.28	0.28
	30 (762mm)	0.61	0.50	0.50	0.61	0.33	0.33
	36 (914mm)	0.61	0.58	0.58	0.61	0.39	0.39
	42 (1067mm)	0.61	0.67	0.61	0.61	0.44	0.44
	48 (1219mm)	0.61	0.75	0.61	0.61	0.50	0.50
	54 (1371mm)	0.61	0.83	0.83	0.61	0.56	0.56
	60 (1529mm)	N/A	0.92	0.92	0.61	0.61	0.61
	72 (1829mm)	N/A	2.11	2.11	N/A	2.11	2.11

Actual (Inches) Height	Width	54 Inch Roll (Linear Yard)			66 Inch Roll (Linear Yard)		
		Directional Rightway	Directional Railroad	Non-Directional	Directional Rightway	Directional Railroad	Non-Directional
Finish Posts							
30 (762mm)		0.10	0.10	0.10	0.08	0.10	0.08
37 (940mm)		0.13	0.19	0.13	0.10	0.10	0.10
44 (1118mm)		0.16	0.19	0.16	0.12	0.19	0.12
50 (1270mm)		0.18	0.19	0.18	0.14	0.19	0.14
56 (1422mm)		0.21	0.19	0.19	0.16	0.19	0.15
64 (1626mm)		0.24	N/A	0.24	0.19	0.19	0.19
68 (1727mm)		0.25	N/A	0.25	0.20	0.19	0.19
82 (2083mm)		0.31	N/A	0.31	0.24	N/A	0.24

Actual (Inches) Height	Width	54 Inch Roll (Linear Yard)			66 Inch Roll (Linear Yard)		
		Directional Rightway	Directional Railroad	Non-Directional	Directional Rightway	Directional Railroad	Non-Directional
Flipper Doors							
16 3/4 (425mm)	24 (610mm)	0.61	0.42	0.42	0.31	0.28	0.28
	30 (762mm)	0.61	0.50	0.50	0.61	0.33	0.33
	36 (914mm)	0.61	0.58	0.58	0.61	0.39	0.39
	42 (1067mm)	0.61	0.67	0.61	0.61	0.44	0.44
	48 (1219mm)	0.61	0.75	0.61	0.61	0.50	0.50
	60 (1529mm)	N/A	0.92	0.92	0.61	0.61	0.61

How to Order

Please refer to specification details on each page for information required for order processing. Rework requires that all orders be in writing to ensure they're complete, to avoid errors, and duplication. Telephone orders will not be processed without written confirmation. Rework will not be held responsible for errors, omissions, and order duplication due to non-compliance with this procedure. Please submit your order to your Rework representative. All products offered are based on availability.

Order Acknowledgments

All purchase orders will be confirmed within 1-2 business days of receipt. Please refer to your Rework acknowledgment to make sure it agrees with your original purchase order. When corresponding, please refer to the Rework proposal number. If you do not receive your confirmation, please contact your Rework representative to ensure the order was received.

Custom Sizes

Please use the next size up for pricing and specify the size needed on the purchase order.

Grommets and Scallops

Please see information on page 16.

Small Orders

Add \$50 net to any high-pressure worksurfaces orders with fewer than three tops.

COM Orders

All COM products must be sent to Rework prepaid. All related costs, including transport, duties, and customs brokerage, are the responsibilities of the customer. Any fees charged to Rework will be invoiced back to the customer. The fabric must meet manufacturer requirements and be pre-approved. The customer is responsible for ordering the correct quantity of materials required for the specific order. Acceptance of customer's own material by Rework does not indicate a guarantee of product durability, nor will Rework be held responsible for any undesirable result with COM products.

All COM to be shipped to the following address and tagged with

Rework proposal number:
Rework Office Furniture
C/O Michalson's Office Furniture
8014 North 2nd
Machesney Park, IL 61115
815-243-6683

Order Changes and Cancellations

Orders may be canceled within two days after the order is acknowledged with no additional charges. After the 2nd business day, a 25% restocking fee will be assessed. After the 5th business day, an order is considered non-cancellable, and 100% of the balance will be due. All changes and cancellations must be submitted in writing and are subject to approval. Changes may result in longer lead times or fees. Products with custom options cannot be canceled or returned.

Payments

All checks can be made payable to Rework, LLC. A 3% surcharge will be added to order amount for any deposits or payments made with any major credit card.

Keying Specific

Rework offers to key all storage components at no additional cost, if requested. Please specify how many sets are needed, and they will be provided as ES Core Key if required to install and is available see page 20.

Prices

All prices listed are suggested list prices. Orders are accepted subject to costs and taxes prevailing at the time of shipment and are subject to change without notice. If the shipping date requested is more than 90 days from the date of an order, Rework shall have the right to use the published list prices at the time of shipment.

Quotations

Quotations are valid for 30 days and based on product availability. The lead time specified in quotation starts when the customer's written purchase order acknowledged by a Rework representative. Expedited lead times will have additional charges applied at the customer's expense. These fees will vary with each expedited order.

Payment Terms

A 50% deposit is required for all orders to be processed. All accounts and orders are subject to credit approval.

Terms (upon acceptance of our credit department)

Net 30 days from the date of invoice. Any product sold shall remain the property of Rework and shall stay the Rework's property until paid for. The purchaser agrees to perform all acts which may be necessary to protect and assure retention of title to such products by Rework by ROE until goods have been paid for in full.

Taxes

Purchaser is responsible for all local, state/federal taxes, and usage fees. Tax-exempt or resale certificates must be submitted when the account is established. Rework is not liable for delay or failure to deliver goods due to causes beyond our control.

Receipt of Product

Rework must be notified 48 hours before order pick up. The product will not be handed over without prior notification. If delivery or installation services are needed, please contact your Rework representative. Rework is not liable for delay or failure to deliver goods due to causes beyond our control.

Freight Terms

F.O.B. Rework's warehouse
7540 Roosevelt Road, Suite D
Forest Park, IL 60130

Storage

Rework offers 30 days of complimentary days of storage for all new sales orders with unexpected delays. After 30 days, additional fees will be incurred.

Changes

Rework reserves the right to make changes, at any time and without prior notice, to prices, colors, materials, specifications, and models offered.

Freight Claims

The merchandise is carefully packaged and thoroughly inspected before leaving the warehouse. The carrier assumes responsibility for its safe delivery upon acceptance of the shipment. Claims for loss or damage sustained in transit must, therefore, be made as follows:

1. Concealed loss or damage

Concealed loss or damage means loss or damage that does not become apparent until the merchandise has been unpacked. The contents may be damaged in transit due to rough handling even though the carton may not show external damage. When damage is discovered upon unpacking, contact a Rework representative within 48 hours. When applicable, submission of photographs will be requested. Your Rework representative will work with you to process the claim as well as replace any product deemed damaged in transit.

Damage does not constitute grounds for a return. Replacement parts are readily available, and Rework reserves the right to attempt correction of the damage while retaining the product in the field.

2. Visible Damage or Shortage

Any external evidence of damage or shortage must be noted on the freight bill of lading or delivery receipt. Failure to adequately describe such external evidence of damage or shortage may result in the carrier refusing to honor a damage claim. If there is obvious shipping damage, you may refuse the product and request that the freight carrier returns the damaged product to Rework. Contact a Rework representative immediately upon receipt of damaged product or shortage.

Seller warrants to the original Purchaser only that the products Seller re-manufactures and sells to Purchaser are free of defects in workmanship and materials during the applicable warranty period set forth below.

With conformity to this limited warranty during the applicable warranty period from the date of shipment, Seller shall, upon prompt written notice, repair or replace, at its option, the affected part or parts.

Product and Period of Warranty

Limited Lifetime on panels

5 Years on all laminate, paint, operational parts, controls, and electrical

3 Years on fabric

1 Year on task light ballasts

This warranty does not apply to:

- Damage caused by a carrier other than the Seller.
- Normal wear and tear or acts or omissions of parties other than Seller (including user modification).
- COM or other third party materials applied to Products.
- Products not installed by or under the auspices of a certified dealer of Seller.
- Dramatic temperature variations or exposure to unusual conditions.

Normal variations in finishes including color, texture and grain variations cannot be avoided, and therefore are not considered defects. Rework does not warrant the color-fastness or matching of colors, grains or textures of such materials.

The express warranties contained herein are in lieu of all other warranties, express or implied, including any warranties of merchantability and fitness for particular purpose and all other warranties arising from course of dealing or usage of trade.

The remedies provided above are the Purchaser's sole remedies for any failure of Seller to comply with its obligations regarding the workmanship of its Products. Correction of any nonconformity in the manner and for the period of time provided shall constitute complete fulfillment of all liabilities of Seller with respect to, or arising out of, the product furnished hereunder.

Delay/Force Majeure

Seller shall not be liable for failure to perform or for delay in performance due to fire, flood, strike or other labor difficulty, act of God, act of any governmental authority or of the Purchaser, riot, embargo, fuel or energy shortage, wrecks or delay in transportation, inability to obtain necessary labor, materials or manufacturing facilities from usual sources or failure of suppliers to meet their contractual obligations, or due to any cause beyond its reasonable control. If any such event occurs, Seller may extend delivery dates by a period of time necessary to overcome the effect of such delay, allocate available product or cancel any purchase order.

Compliance with Law

Purchaser is solely responsible for compliance with all applicable federal, state and local laws, ordinances, regulations, rules and standards relating to the installation, maintenance, use and operation of the products.



rework

7540 Roosevelt Road
Forest Park, IL 60130
www.rework-furniture.com
furniture@rework-furniture.com
P 800.763.9100
F 773.379.5221