

GAS-FIRED



LISTED

MODELS

Natural Gas	Description	Propane
FPB-19RBSTMSI-N	19" Round Stainless Pan & Spur Kit	FPB-19RBSTMSI-P
FPB-25RBSTMSI-N	25" Round Stainless Pan & Spur Kit	FPB-25RBSTMSI-P
FPB-29RBSTMSI-N	29" Round Stainless Pan & Spur Kit	FPB-29RBSTMSI-P
FPB-33RBSTMSI-N	33" Round Stainless Pan & Spur Kit	FPB-33RBSTMSI-P
FPB-20SBSTMSI-N	20" Square Stainless Pan & Spur Kit	FPB-20SBSTMSI-P
FPB-26SBSTMSI-N	26" Square Stainless Pan & Spur Kit	FPB-26SBSTMSI-P
FPB-32SBSTMSI-N	32" Square Stainless Pan & Spur Kit	FPB-32SBSTMSI-P
FPB-38SBSTMSI-N	38" Square Stainless Pan & Spur Kit	FPB-38SBSTMSI-P

Outdoor Thermocouple Manual Safety (TMSI) Fire Pits

Installation and Operating Instructions

IF YOU CANNOT READ OR UNDERSTAND THESE INSTALLATION INSTRUCTIONS DO NOT ATTEMPT TO INSTALL OR OPERATE THIS APPLIANCE

INSTALLATION PRECAUTION:

This fire pit requires a minimum 18-square inches (per side) of cross ventilation. Failure to provide proper ventilation can void the warranty.





Warning: For Outdoor Use Only



We recommend that our gas hearth products be installed and serviced by professionals who are certified in the U.S. by the National Fireplace Institute® (NFI) as NFI Gas Specialists.

PLEASE RETAIN THIS MANUAL FOR FUTURE REFERENCE

 <p>DANGER</p>	<p align="center">CARBON MONOXIDE HAZARD</p> <p>This appliance can produce carbon monoxide which has no odor.</p> <p>Using it in an enclosed area can kill you.</p> <p>Never use this appliance in an enclosed space such as a camper, tent, car or home.</p>
	

 <p>DANGER</p> <p>If you smell gas:</p> <ol style="list-style-type: none"> 1. Shut off gas to the appliance 2. Extinguish any open flame. 3. If odor continues, keep away from the appliance and immediately call your gas supplier or fire department.
--

 <p>WARNING</p> <p>Do not store or use gasoline or other flammable vapors and liquids in the vicinity of this or other appliances.</p> <p>Any LP cylinder not connected for use shall not be stored in the vicinity of this or other appliances.</p>

<p align="center">WARNING</p> <p>Do not leave unattended during use. Do not use for cooking. Follow all gas leak procedures in this manual prior to operation.</p>

 <p>WARNING</p> <p>Improper installation, adjustment, alteration, service or maintenance can cause injury or property damage. Read the installation, operating and maintenance instructions thoroughly before installing or servicing this equipment.</p>
--

<p align="center"><u>WARNING</u></p> <p>If the information in these instructions is not followed exactly, a fire or explosion may result causing property damage, personal injury or death.</p> <p align="center"><u>FOR YOUR SAFETY</u></p> <p>Do not store or use gasoline or other flammable vapors and liquids in the vicinity of this or other appliances.</p>



Fuels used in gas fired appliances, and the products of combustion such as fuels, contain chemicals known to cause cancer, birth defects and/or other reproductive harm. This warning is issued pursuant to the California Health & Safety Code Sec. 25249.1

TABLE OF CONTENTS

Specifications	4
Preparation for Non-Combustible Structure	5
Hard Piping to Fire pit	5
Cross Ventilation Requirements	5
High Elevation	5
Gas Pipe Sizing Chart	6
Installation into an Approved Enclosure	7
Installing Gas Valve	8
Typical Installation Drawings	8-9
Installation of Lava Rock/Media	8
Operation	10
Lighting Instructions	10
Replacement Parts	11
Replacement Parts List	12
Maintenance/ Trouble Shooting	13
Optional Accessories	14



All media (i.e. lava rock, lava stones, lava boulders and fire glass) has the potential of thermal spalling. This is a process that may occur when media is wet and moisture gets trapped inside of the material due to rapid temperature differences. When this happens the media has the potential to crack or “pop” outside the fireplace.

WE HIGHLY RECOMMEND COVERING ALL FIRE FEATURES WHEN NOT IN USE

The use of a cover can lessen the impact of thermal spalling; however, heavy rains, high humidity and the presence of moisture may still cause the media to pop.

ALWAYS USE CAUTION WHEN USING THE FIRE FEATURE

Extra caution should be taken when lighting a fireplace when heavy rains, high humidity and moisture are present. Light the fireplace; leave the area allowing any moisture in the media to dissipate. We strongly recommend that during this drying out time that you monitor the fire feature from a distance. This drying out period should be no less than 30 minutes. Continue monitoring the flame from distance to ensure that all popping has ceased before fully enjoying the fire.

TMSI SPECIFICATIONS

Model: Natural Gas (NG)	Model: Propane Gas (LP)	A Pan Depth	B Min/Max Install Opening	C Inside Pan	D Ground Level	E Side Wall	F Combustible Ceiling	G Combustible Floor
FPB-19RBSTMSI-N	FPB-19RBSTMSI-P	2 ¾"	19 ¼" - 21 ½"	19"	8"	16"	54"	18"
FPB-25RBSTMSI-N	FPB-25RBSTMSI-P	2 ¾"	25 ¼" - 27 ½"	25"	8"	19"	69"	18"
FPB-29RBSTMSI-N	FPB-29RBSTMSI-P	2 ¾"	30" - 31 ⅜"	29"	8"	19"	69"	18"
FPB-33RBSTMSI-N	FPB-33RBSTMSI-P	2 ¾"	34" - 35 ¼"	33"	8"	19"	69"	18"
FPB-20SBSTMSI-N	FPB-20SBSTMSI-P	2 ¾"	20 ¼" - 21 ¾"	20"	8"	16"	54"	18"
FPB-26SBSTMSI-N	FPB-26SBSTMSI-P	2 ¾"	26 ¼" - 27 ¾"	26"	8"	19"	69"	18"
FPB-32SBSTMSI-N	FPB-32SBSTMSI-P	2 ¾"	32 ¼" - 33 ¾"	32"	8"	19"	69"	18"
FPB-38SBSTMSI-N	FPB-38SBSTMSI-P	2 ¾"	38 ¼" - 39 ¾"	38"	8"	19"	69"	18"

Table 1. Fire pit Dimensions

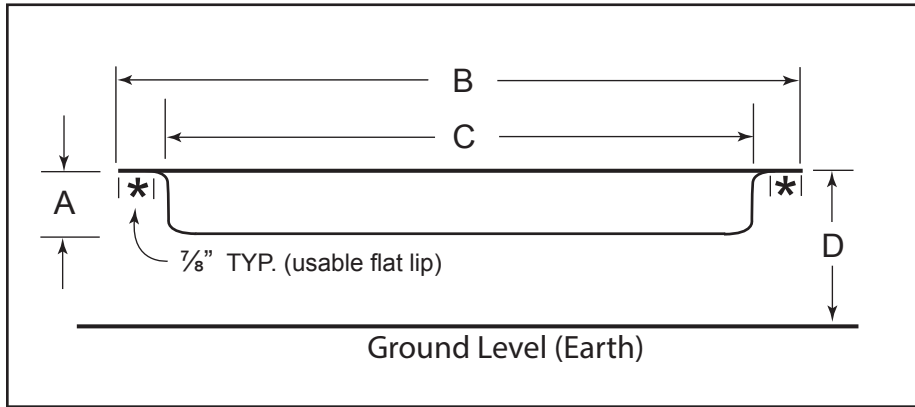

Fig 1. Fire pit dimensions; refer to Table 1. (Dimensions applicable to round or square pans)

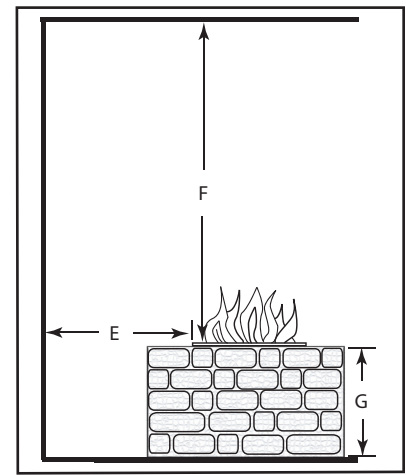

Fig 2. Clearance to Combustibles
(Not to be used in an enclosed space)

Model: Match Throw NG	NG Factory Orifice	NG Btu's	Model Match Throw LP	LP Factory Orifice	LP Btu's
FPB-19RBSTMSI-N	#29	65,500	FPB-19RBSMT-P	#41	65,000
FPB-25RBSTMSI-N	#29	65,500	FPB-25RBSMT-P	#41	65,000
FPB-29RBSTMSI-N	#29	65,500	FPB-G29RBSMT-P	#41	65,000
FPB-33RBSTMSI-N	#29	65,500	FPB-G33RBSMT-P	#41	65,000
FPB-20SBSTMSI-N	#29	65,500	FPB-20SBSMT-P	#41	65,000
FPB-26SBSTMSI-N	#29	65,500	FPB-26SBSMT-P	#41	65,000
FPB-32SBSTMSI-N	#29	65,500	FPB-32SBSMT-P	#41	65,000
FPB-38SBSTMSI-N	#29	65,500	FPB-38SBSMT-P	#41	65,000

Table 2 Btu Specifications

Disclaimer: Btu listings are based on 7.0"WC for Natural Gas and 11.0"WC for Liquid Propane (LP) to the gas valve. Flex line size and proper gas pipe sizing will also affect Btu's. As a result your Btu's may vary slightly from Table 2 specifications.

Pressure	NG	LP
Min. Inlet	5.0" WC	10.5" WC
Max. Inlet	10.5" WC	13.0" WC
Normal Inlet	7.0" WC	11.0" WC

Table 3 Gas Pressures



WARNING: Proper clearances from combustible materials must be maintained from all sides, top and bottom of this appliance. Use the specifications listed on page 3 for proper clearance to combustibles.

PREPARING A NON-COMBUSTIBLE STRUCTURE

The fire pit can be installed on a flat, stable surface, away from any combustible materials. Install fire pit on any level, outdoor non-combustible, flat stable surface or a combustible floor according to the clearances specified in this manual. **NOTE:** Do not place fire pit directly on grass, dirt, or rocks as this may prevent proper ventilation (Fig. 3). **Ensure proper water drainage is also incorporated into the fire pit enclosure.**

HARD PIPING TO FIRE PIT WITHOUT GAS PROXIMITY

NOTE: Refer to the NFPA54 (National Fuel Gas Code) for proper pipe sizing. See gas line sizing chart on page 6 as a reference.

1. Turn **OFF** gas supply system. **NOTE:** All gas connections (except for brass to brass) require the following. Clean pipe threads using either a wire brush or steel wool. Apply pipe sealant to the fittings before making any connection.
2. **BE CAREFUL!** Ensure all gas connections are snug, but do not over tighten!
3. Consult a plumber for proper installation to ensure you are providing adequate gas supply for your application.
4. The primary gas shut-off (not supplied) will require a ½" male flared fitting to enable connection of the stainless steel flex gas line supplied with the fire pit.
5. Do not place an LP tank inside any fire pit enclosure. Locate all propane (LP) tanks outside the enclosure.
6. To prevent performance problems in Propane (LP) fire pits, do not use a Propane tank less than 100lbs. capacity.

IMPORTANT

Installation of Natural or LP gas should be done by a qualified installer, service agency or gas supplier. The appliance and its manual shutoff valve must be disconnected from the gas supply piping system during any pressure testing of the system at test pressures in excess of ½" psig (3.5kPa). This appliance must be isolated from the gas supply piping system by closing its manual shutoff valve during any pressure testing of the gas supply piping system at test pressures equal to or less than ½" psig (3.5kPa)

VENTILATION FOR NON-COMBUSTIBLE ENCLOSURE

Fire pits are subjected to many outdoor elements such as rain, snow, wind, heat or cold. **A minimum of 18 square inches of cross ventilation (2 sides) is required to keep the components in good working order.** Use Fig 3 as guide to assist to incorporate proper ventilation.

HIGH ELEVATION INSTALLATION

This appliance is listed for elevations from 0- 4500 feet in Canada and the U.S. If elevation exceeds 4500 feet it may be necessary to decrease the input rating by changing the existing burner orifice to a smaller size. Input should be reduced 4% for each 1000 feet beyond the 4500 feet above sea level. Check with your local gas utility for assistance in determining the proper orifice in your location. In some cases the heating value may already be reduced and downsizing the orifice may not be necessary. Refer to NFPA54 Table E.1.1(d) for high altitude orifice sizing.

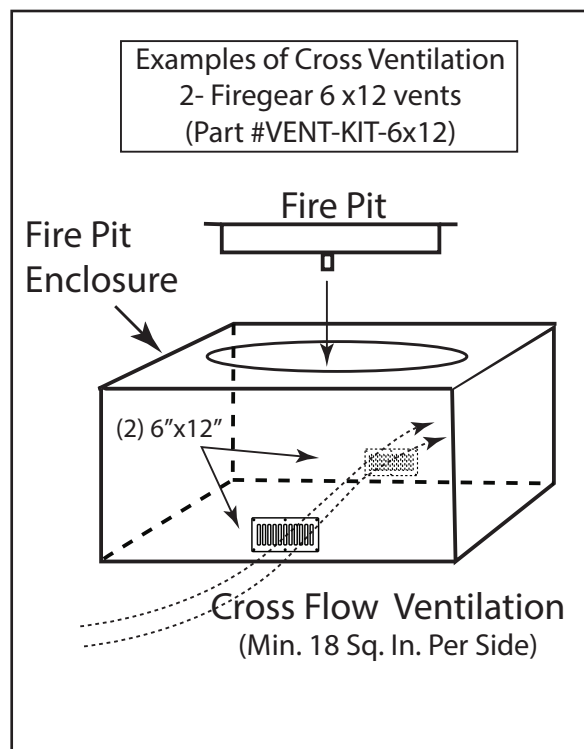

Fig 3. Cross Ventilation Example

GAS PIPE SIZING CHART

NATURAL GAS : PIPE SIZING CHART

Length of Pipe in Feet	1/2"	3/4"	1"	1 - 1/4"	1 - 1/2"	2"	2 - 2 1/2"	3"	4"
10	108	230	387	793	1237	2259	3640	6434	-
20	75	160	280	569	877	1610	2613	5236	9521
30	61	129	224	471	719	1335	2165	4107	7859
40	52	110	196	401	635	1143	1867	3258	6795
50	46	98	177	364	560	1041	1680	2936	6142
60	42	89	159	336	513	957	1559	2684	5647
70	38	82	149	317	476	896	1447	2492	5250
80	36	76	140	239	443	840	1353	2315	4900
90	33	71	133	275	420	793	1288	2203	4667
100	32	68	126	266	411	775	1246	2128	4518
125	28	60	117	243	369	700	1143	1904	4065
150	25	54	105	215	327	625	1008	1689	3645
175	23	50	93	196	303	583	993	1554	3370
200	22	47	84	182	280	541	877	1437	3160
300	17	37	70	145	224	439	686	1139	2539

- Natural Gas (NG) flow is given in thousands of BTU/hr. = 1 cubic foot of NG gas - 1000 BTU
- Nominal pressure at the burner for Natural Gas is 3.5" of water column. (Typical machine supply 5"-7")
- Pipe length must include additional length for all fittings. Add approximately 5 feet of pipe per fitting.
- Natural Gas Example: A machine with a burner that requires 440,000 BTU would need a 1 -1/4" pipe for a 20" long run.

LIQUID PROPANE : PIPE SIZING CHART

Length of Pipe in Feet	1/2"	3/4"	1"	1 - 1/4"	1 - 1/2"	2"	2 - 2 1/2"	3"	4"
10	275	567	1071	2205	3307	6221	10140	17990	35710
20	189	393	732	1496	2299	4331	7046	12510	25520
30	152	315	590	1212	1858	3465	5695	10110	20620
40	129	267	504	1039	1559	2992	4778	8481	17300
50	114	237	448	913	1417	2646	4343	7708	15730
60	103	217	409	834	1275	2394	3908	6936	14150
70	89	185	346	724	1086	2047	3329	5908	12050
80	78	162	307	630	976	1811	2991	5309	10830
90	69	146	275	567	866	1606	2654	4711	9613
100	63	132	252	511	787	1496	2412	4281	8736
125	54	112	209	439	665	1282	2083	3618	7382
150	48	100	185	390	590	1138	1808	3210	6549
175	43	90	168	353	534	1030	1637	2905	5927
200	40	83	155	325	491	947	1505	2671	5450
300	37	77	144	303	458	887	1404	2492	5084

- Liquid Propane (LP) Gas flow is given in thousands of BTU/hr. = 1 cubic foot of LP gas - 2500 BTU.
- This chart refers to low pressure LP, after regulation, Standard nominal pressure at the burner for Liquid Propane Gas is 11" of water column.
- Pipe length must include additional length for all fittings. Add approximately 5 feet of pipe per fitting.
- LP Example: A machine with a burner that requires 440,000 BTU would need a 1" pipe for a 20' long run.

NOTE: The sizing charts above list the specific pipe sizes required for the amount of BTU's for a new gas line installations. If you are using an existing gas line you must take into consideration the existing gas line capacities to ensure you will have proper pressure. **This chart is for reference only, we recommend you consult with a Licensed Plumber/Gas Fitter or NFPA54 (National Fuel Gas Code - current edition) for more details.**

Table 4 Gas Pipe Sizing Chart



INSTALLATION OF FIRE PIT INTO AN APPROVED ENCLOSURE

REQUIREMENTS

1. Only non-combustible materials should come in direct contact with any part of the fire pit. If the area underneath should be a flat level combustible surface according to the clearances specified in this manual on page 3.
2. Refer to the NFPA54 (National Fuel Gas Code) for proper pipe sizing. See Table 4 on page 6.
3. Determine the size of the round or square fire pit you are preparing to install (Refer to page 4).
4. You must provide a round or square cut-out opening to place the fire pit into the non-combustible enclosure. Do not exceed the maximum opening from Table 1, dimension B.
5. Follow the local code requirements for the gas type being used. This fire pit should be installed in accordance with local codes and ordinances or in the absence of local codes, with the latest National Fuel Gas Code, ANSI Z223.1 NFPA54 or CSA B149.1, Natural and Propane Installation Code in Canada.
6. Fire pits create high temperatures, it is very important to have any combustibles at a safe distance.
7. **CAUTION: A minimum of 18 square inches of cross ventilation (per side) is required to keep the inside of the enclosure dry. We recommend installation of a VENT-KIT-6x12SS. See accessory page 12.**
8. These products are designed for outdoor use only. Not approved for any indoor use.
9. This fire pit is designed to have lava rock completely covering the spur burner, so that the burner is not visible. Do not cover more than 1" above the top of the covered burner. When purchasing Lava Rock use minimum of 1 to 2-inch diameter as a base to fill the burner pan. **DO NOT COVER THE IGNITION HOOD WITH ANY ROCK OR MEDIA.**
10. Gas lines and fittings must be installed in to the non-combustible structure. All gas connections must be leak tested before installation of the fire pit. Soapy water leak detection is required before regular use of the fire pit.
11. Do not use material that will absorb moisture over time and will not release this moisture quickly. Moisture can boil in this material and can rapidly break apart and cause damage or personal injury.
12. Never leave any other combustible material on top of the fire pit. This could cause unsafe operation of this system and damage to the component that will not be covered under our warranty.



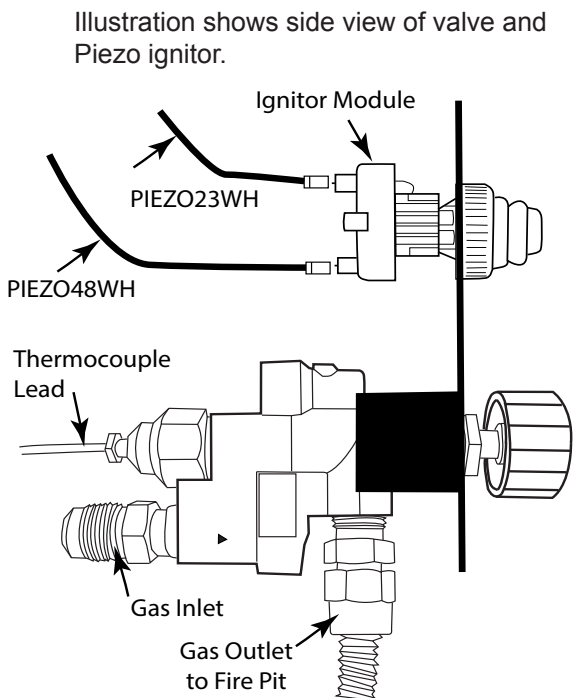

Fig. 4 TMSI typical installation.

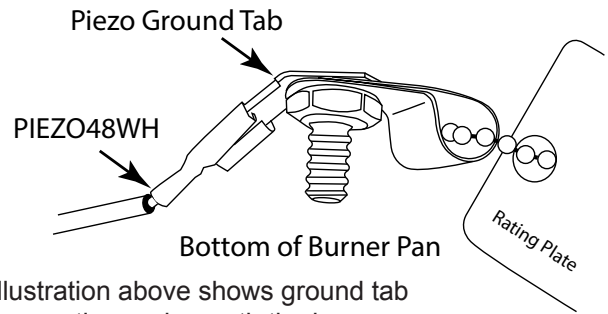
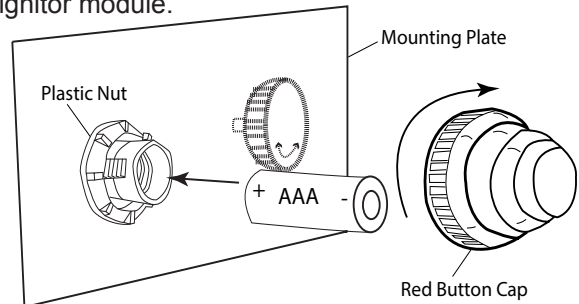

Illustration above shows ground tab connection underneath the burner pan.

Remove red button cap and install battery into Piezo ignitor module.



THERMOCOUPLE ALIGNMENT

It is important check the thermocouple to ensure it is properly aligned overtop of the rainshield cutout area and that it did not move during shipping. Before lighting remove the screen cover of the ignition hood to burner and visually look at the thermocouple tip. The tip must be centered and protruding past the cutout area to ensure it remains hot during operation of your fire pit. Replace the screen cover and follow the operating instructions after inspection.

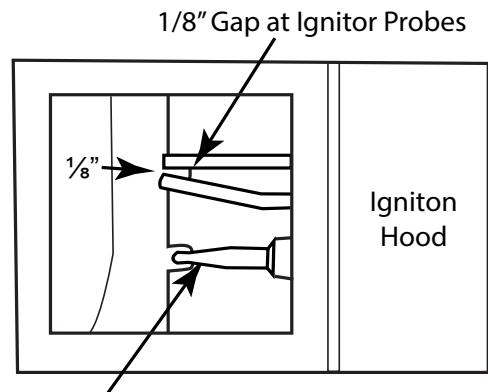

Thermocouple
Fig. 5 Proper alignment of probes and thermocouple.

INSTALLATION OF LAVA ROCK/MEDIA INTO BURNER PAN

Install lava rock into the burner pan. Ensure the lava rock is a 1 to 2-inch diameter for proper operation. **Note:** Do not pour Lava Rock directly from bag. It should be placed naturally and NOT packed in tight. Loose fitting is important to ensure robust flames. Be sure rocks are free of any excessive dust. This prevents the burner pan weep holes from being plugged and holding water.

IMPORTANT: Do not place rock over top or under the screen cover. The screen must be free of any debris to ensure proper lighting of burner and good flame sense (See fig. 6).

Cover the burner completely with media but do not make the depth greater than 1-inch overtop of the burner portholes.

Do NOT cover the screen mesh with any rock or glass. It must be free an any debris to operate properly.

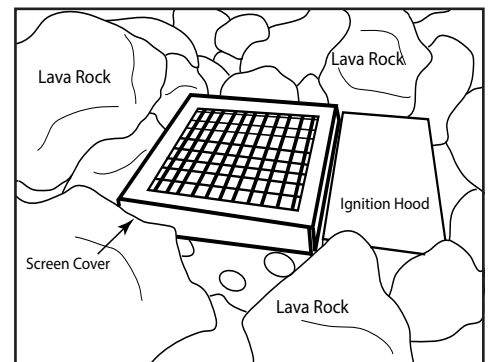

Fig.6 Keep screen cover exposed

Ready to Finish (RTF) Enclosure Illustration

Cement Block Illustration

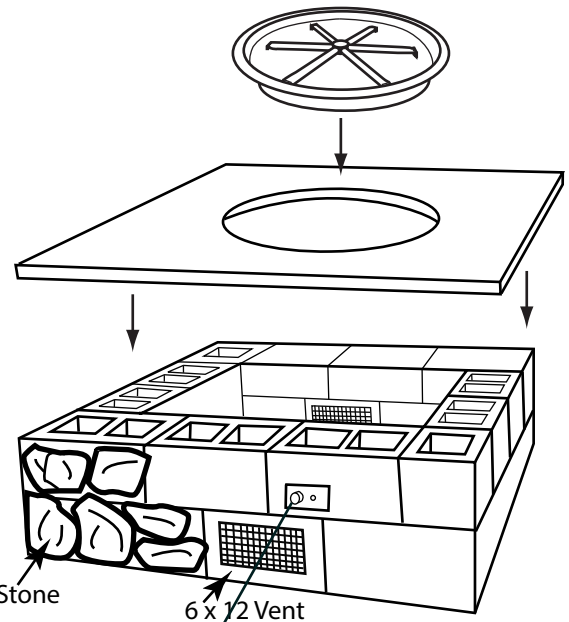
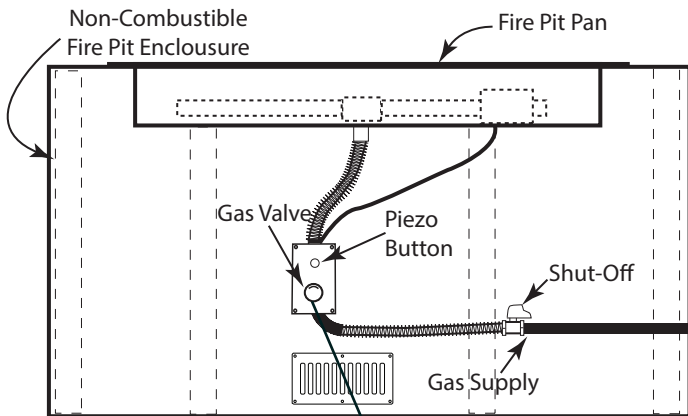
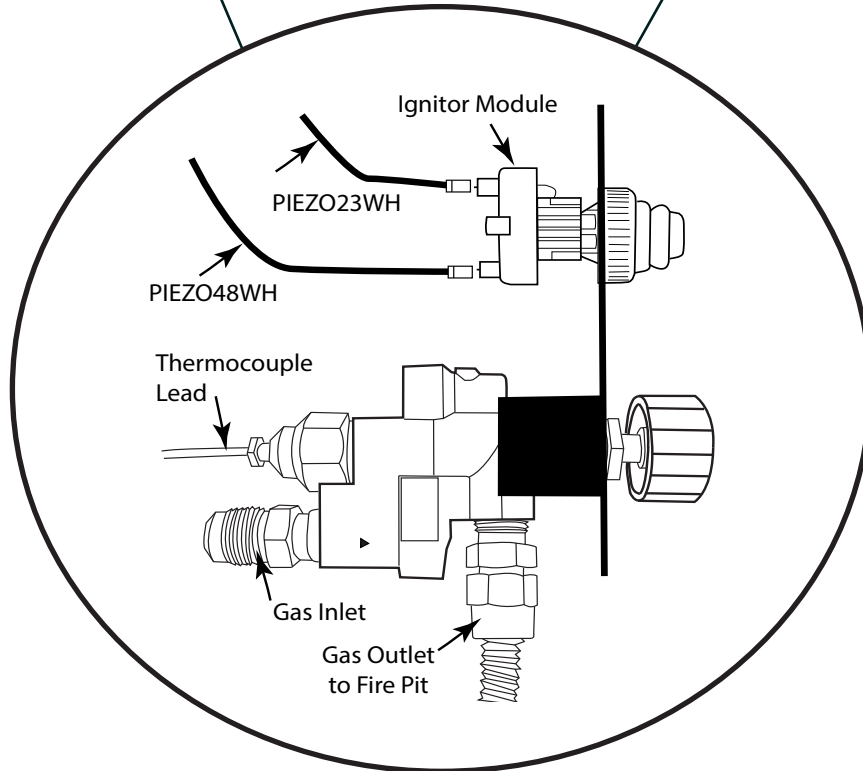

Fig. 7 Typical installation.

NOTE: Gas valve, flexible gas lines and TMSI components supplied.
Gas shut-off is not supplied.



Ensure you determine how to mount valve bracket into place before completing fire pit.
See optional mounting method of TMSI face plate on back page of this manual.

OPERATION

CAUTION: Children and adults should be alerted to the hazards on high surface temperatures and should stay away to avoid burns or clothing ignition. Young children should be carefully supervised when they are in the area of the appliance.

WARNING: Do not use this appliance if any part has been under water. Immediately call a qualified service technician to inspect the appliance and to replace any part of control system and any gas control, which has been under water.

SAFETY WARNINGS

1. Never leave the fire pit unattended during operation.
2. Clothing or other flammable materials should not be placed on or near the appliance.
3. Any guard or other protective device removed for servicing the appliance must be replaced prior to operating the appliance.
4. Installation and repair should be done by a qualified service person. The appliance should be inspected before use and at least annually by a qualified service person. More frequent cleaning may be required as necessary. It is imperative the control compartment, burners and circulating air passageways of the appliance be kept clean.
5. Inspect the fuel supply connection before each use of the appliance.
6. Temporary storage of this appliance indoors is permissible only if it has been disconnected from its fuel supply (Natural or L.P. gas line).

WARNING

1. This appliance is hot when operated and can cause severe burns if contacted.
2. Do not burn any solid fuels in this appliance.

READ ALL LIGHTING INSTRUCTIONS BEFORE ATTEMPTING TO LIGHT FIRE PIT

CAUTION: ENSURE YOU HAVE LEAK TESTED THE FIRE PIT BEFORE OPERATING.

WARNING: Do not stand over fire pit during ignition or operation due to high surface temperatures.

LIGHTING INSTRUCTIONS

TURNING ON FIRE PIT

1. Depress and hold the red Piezo ignitor button and ensure sparking is occurring at the probes inside ignition hood.
2. Rotate control knob on gas valve counter clockwise to the ON position.
3. Depress control knob inward to light the burner.
4. After the fire pit lights release the Piezo button but continue to depress the control knob for at least 30 seconds then release knob. If fire pit does not light within 30 seconds, release control knob, turn knob clockwise to turn OFF and wait 5 minutes before trying again. Turn gas supply OFF to check probe spacing and Piezo battery if fire pit does not light.
5. Repeat steps 1-4.

TURNING OFF FIRE PIT

1. Slight push inward on control knob and turn clockwise until it stops. Fire pit will turn OFF.
2. After cooling off install cover.

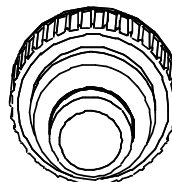

Red Piezo Button

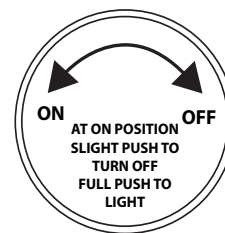

Control Knob

Fig. 8. Gas Valve Knob

FPB ROUND AND SQUARE TMSI REPLACEMENT PARTS

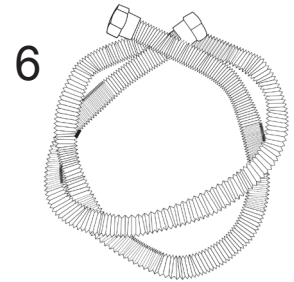
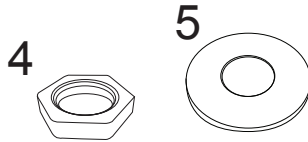
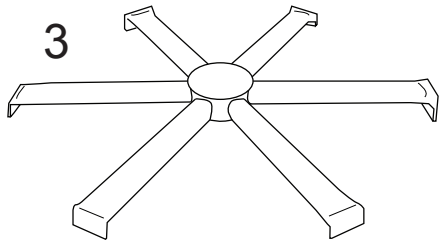
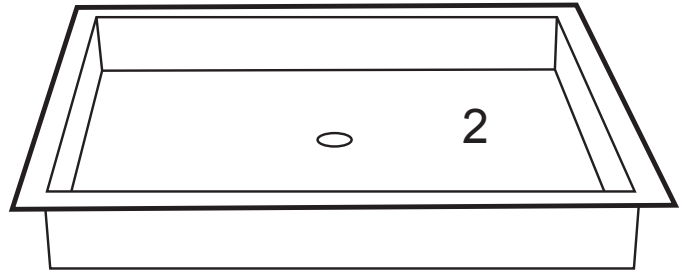
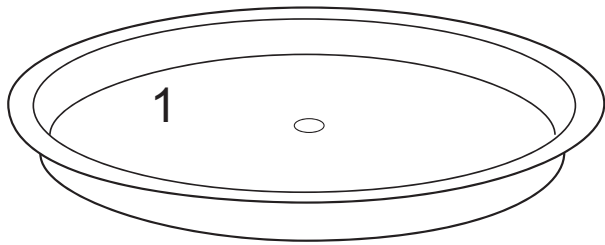

Drawings No to Scale

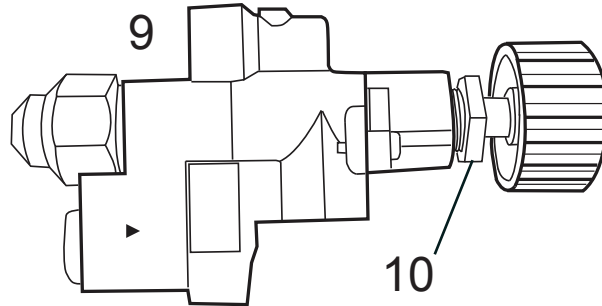
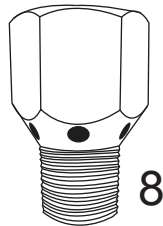
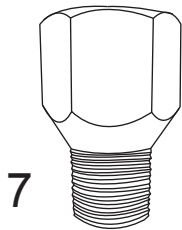

11

10

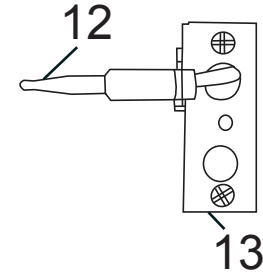

13

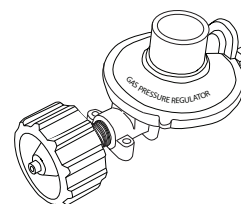
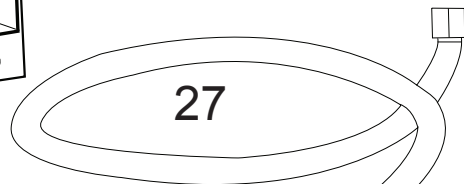
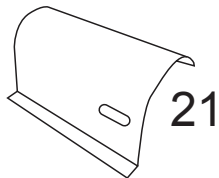
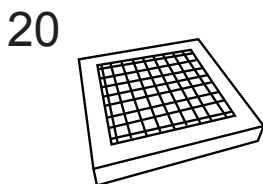
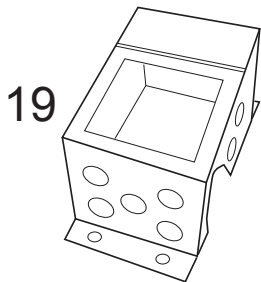
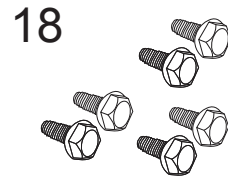
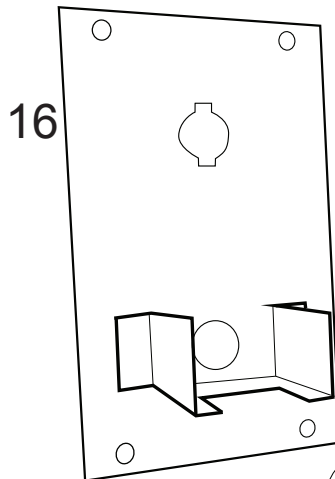
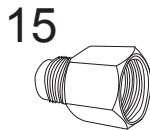
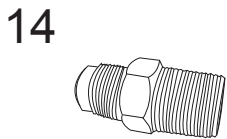

FPB ROUND AND SQUARE TMSI REPLACEMENT PARTS

Item	Description	Qty.	Part Number
1	19-inch Round Stainless Pan	1	PAN-SS19R
1	25-inch Round Stainless Pan	1	PAN-SS25R
1	29-inch Round Stainless Pan	1	PAN-GV29RP2
1	33-inch Round Stainless Pan	1	PAN-GV33RP2
2	20-inch Square Stainless Pan	1	PAN-SS20S
2	26-inch Square Stainless Pan	1	PAN-SS26S
2	32-inch Square Stainless Pan	1	PAN-SS32S
2	38-inch Square Stainless Pan	1	PAN-SS38
3	16-inch Spur (used on 19" & 20" Pans)	1	B-SPUR16
3	22-inch Spur (used on 25", 26", 29", 32", 38" Pans)	1	B-SPUR22
4	1/2" NPS Brass Nut	1	105-8
5	7/8" Flat Washer/Spacer	1	ST3-113-1026
6	Tranquiline 1/2" Flex Gas Line (46-inch Length)	1	T-200-9898-46
7	Air Shutter Orifice NG (Used on Natural Gas Models)	1	OAS-NG29
8	Air Shutter Orifice LP (Used on Propane Models)	1	OAS-LP41
9	Copreci Manual Gas Valve	1	ST3-080-1009
10	Mounting Nut for Copreci Valve	1	ST3-110-1005
11	Manual Gas Valve Knob for Copreci Valve	1	ST3-050-1024
12	Copreci Thermocouple	1	ST3-040-1025
13	Thermocouple Bracket	1	VCS-5000DSIB01
14	1/2" OD Flare to 3/8" MIP Fitting	1	U1-8C-S
15	1/2" NPT Female to 1/2" Male Flare Fitting	1	U3-8D-S
16	TMSI Valve Mounting Plate	1	TMSIFACEPLATE
18	Stainless Steel Thread Cutting Screws #10-24x 1/2"	8	ST3-113-1028
19	Ignitor Hood for Spur Burner	1	SPURHOOD
20	Mesh Screen Cover (for ignition hood)	1	ST3-100-1027
21	Rain Shield for Spur Burner Leg	1	RAINSHIELD
22	#10-24 x 1.25" Black Oxide Phillips Screw	4	SCREW1024PANBL
23	#10-24 Stainless Nut	5	ST3-113-1020
24	#10 Stainless Flat Washer	4	WASHER10SS
25	Copreci Valve Knob Label Sticker (not shown)	1	VALVEKNOBLABEL
26	Thermocouple/Rainshield Replacement Kit (not shown)	1	TMSI-TC-ASSEMBLY
27	* LP Regulator with 32" Hose	1	FG-32LPHRK
28	3/8" NPT-M to 3/8" Flare (for LP models)	1	U1-6C-S
29	Manual Spark Ignitor Module (not shown)	1	3042-RB
30	23" Piezo Extension wire - See page 16 (not shown)	1	PIEZO23WH
31	48" Piezo Extension wire - See page 16 (not shown)	1	PIEZO48WH
32	Ground tab for Piezo ignition (not shown)	1	GROUNDTAB

FIRE PIT MAINTENANCE

1. The fire pit should be inspected and cleaned before initial use at least annually by a qualified field service person.
2. Any component that is found faulty must be replaced with an approved component.
3. Any tampering or modifying with the fire pit is dangerous and voids all warranties.
4. During winter months in cold climates and various seasons operation the fire pit may be affected by weather conditions. It is recommended to use a cover/lid overtop of your fire pit to protect it from humid/rainy weather conditions when not in use. Heavy rains/downpours could affect the fire pit operation if not covered; if this occurs ensure you allow the fire pit time to dry out before attempting to operate. **NOTE:** If a combustible type cover is used over the fire pit when not in use be sure to remove it before operation to prevent a severe safety hazard.
5. Carbon (soot) may build up on the surface of logs (if installed) during heavy use. Sooting may also occur periodically on the screen of the ignitor hood. To clean, brush off with a dry bristle brush or cloth. Keep soot away from clothing or furniture.
6. Over time stainless steel parts can discolor when heated, usually a golden or brown hue. This discoloration is normal and does not affect the performance of the appliance.

TROUBLE SHOOTING

<u>Symptom</u>	<u>Remedy</u>
Fire pit won't light	<ol style="list-style-type: none">1. Bleed gas line.3. Ensure all gas supply lines are turned ON.4. Ensure there is not too much media overtop of burner; it can inhibit gas from flowing.
Low Flame	<ol style="list-style-type: none">1. Ensure the base media is at least 1-inch in diameter and top media is no more than 1-inch over top of burner.2. Ensure all shut-off valves and valve is fully open. See page 8; figure 10.3. Check for spider webs inside burner orifice.
Water in my fire pit	<ol style="list-style-type: none">1. Excess dust/sand material from media may be blocking the weep holes to relieve water. Remove all media and unplug weep holes. Clean or install new media free of dust and dirt.2. Ensure fire pit enclosure has proper drainage for water and proper ventilation to dry out.3. Recommend to purchase a cover/lid to keep excessive water out of the fire pit.
Whistling Noises	<ol style="list-style-type: none">1. Check media to ensure it is not too tightly packed around the burner tube.2. Ensure a non-whistling flex connector is being used.
Fire pit won't stay lit	<ol style="list-style-type: none">1. Check alignment of thermocouple over rainshield on page 6, figure #5.2. Ensure thermocouple is not screwed too tight into gas valve. It should be finger tight plus a quarter turn with a wrench.3. Ensure thermocouple is clean and free of any debris. Excessive soot can be an issue.



LIMITED WARRANTY

Skytech Products Group (Firegear Outdoors) hereby warrants to the end user that products will be free from material and workmanship defects that prevent safe and correct operation of the product. The warranty commences from date of sale to the end user for the following period:

CONSUMER/NON-COMMERCIAL APPLICATIONS:

Stainless Steel Components	5 Years
Gas Valve, Spark Igniter & Electronic Parts	2 Years
Log Sets	3 Years
Glass Windshields	5 Years
Glass Media	1 Year
Controls	5 Years
AnF Enclosures	5 Years

Lava Rock and Lava Stones are not covered by warranty

COMMERCIAL APPLICATIONS:

Stainless Steel Components	1 Year
Gas Valve, Spark Igniter & Electronic Parts	1 Year
Log Sets	1 Year
Glass Windshields	1 Year
Glass Media	1 Year
Controls	1 Year
AnF Enclosures	1 Year

Lava Rock and Lava Stones are not covered by warranty

End User must provide a bill of sale, canceled check, or payment record from the end user to verify purchase date and to establish warranty period. This Limited Warranty shall be valid and limited to the original purchaser only.

WARNING Any modification to the product will void the warranty.

This Limited Warranty shall be limited to the repair and/or replacement of parts that have proven to be defective under normal use and service. Before returning any parts, contact our Technical Service Department for a Return Materials Authorization (RMA) number. All warranty claims must be made by the OEM / Distributor / Dealer account on behalf of the end user. You may contact Technical Service at (855) 498-8324.

All approved returned defects must be confirmed by our Technical Service Department. If the defect is confirmed and we approve the claim, we will replace such parts without charge.

This warranty gives you specific legal rights, and you may also

Travel, diagnostic cost, service labor to repair the defect and freight charges on warranty parts to and from the factory will be responsibility of the owner. We will not be responsible for labor charges and/or damage incurred in installation, repair, and replacement.

This Limited Warranty is voided if not assembled, installed and operated as intended. This Limited Warranty does not cover any defects due to accident, abuse, misuse, alteration, misapplication, vandalism, improper installation or improper maintenance or service, removal from the original location or re-installation into another location, or failure to perform normal and routine maintenance.

Damage due to severe weather conditions such as hail, hurricanes, earthquakes, tornadoes, discoloration due to over-heating, exposure to chemicals (including salt), either directly or in the atmosphere, or very high humidity, is not covered by this Limited Warranty.

There are no other express warranties except as set forth herein. For consumer applications, any applicable implied warranties of merchantability and fitness are limited in duration to the period of coverage of this Limited Warranty. Some states do not allow limitation on how long an implied warranty lasts, so this limitation may not apply to you.

For Commercial applications, the liability of Firegear Outdoors is limited to the express terms of this warranty. We expressly disclaim any and all implied warranties, including any warranties of fitness for a particular purpose or merchantability.

We are not liable for any special, indirect or consequential damages. Our maximum liability is limited to the purchase price of the purchased products. Some states do not allow the exclusion or limitation of incidental or consequential damages, so this limitation or exclusions may not apply to you.

We do not authorize any person or company to assume for it any other obligation or liability in connection with the sale, installation, use, removal, return, or replacement of its equipment; and no such representations are binding.



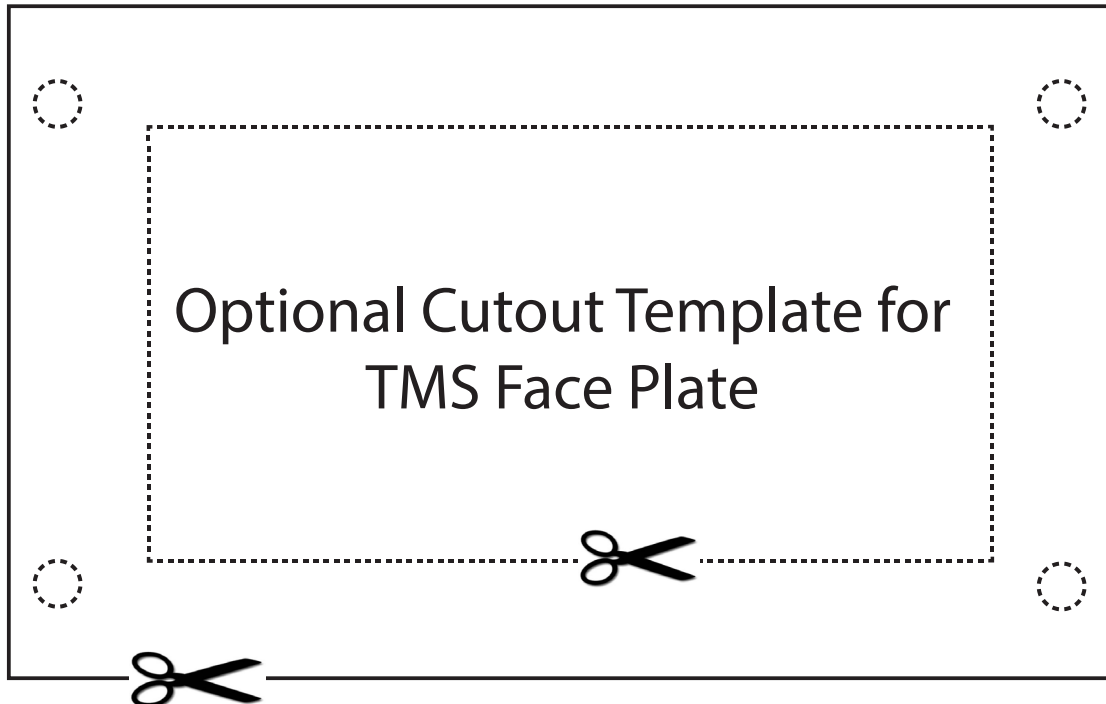

This fire pit instruction provides an option to mount the TMSI face plate to concrete board. Use the template above to complete the installation.

The TMSI face plate can be mounted vertically or horizontally. Our suggestion is to attach the face plate in a horizontal position with the gas valve on the left side. This allows the control knob text to be orientated in a position to be easily read.

Using scissors carefully cutout the template and trace it on your concrete board. The dotted line provides the cutout area to mount face plate. Use a concrete drill bit to drill (4) 3/16" diameter holes. Install the 1¼" black oxide screws through the front of the faceplate with the nuts and washers on the backside. These are all provided in the hardware bag.

CAUTION: Careful not to over-tighten screws and nuts to ensure the cement board does not crack or break.



Having problems getting the fire pit to operate? Don't leave the job site!
We want to help! Call 855.498.8324 for Technical Support
between the hours of 8:00AM to 5:00PM EST.
Text photos to 260.255.5750 or e-mail photos to support@skytechpg.com.

BEFORE YOU CALL WE WILL NEED THIS INFORMATION

1. Model Number: _____
2. Serial Number: _____
3. How long is the gas line run? Nat Gas ____ LP Gas ____
4. What size is gas line? _____
5. Inlet Gas Pressure: _____ WC
Manifold Gas Pressure: _____ WC
6. What type of media are you using? _____
7. Review the troubleshooting section in the installation manual.
8. What are the symptoms? Please be prepared to explain.
9. Be prepared to send photos to us when on the phone.
10. Found missing or damaged parts? Let us know ASAP or send photos.