

AnF “Assemble-n-Finish” Fire Pit Enclosures

Model	Description
ANF-R42	42” x18” enclosure fits FPB-16R/19R & FPB-20S
ANF-R48	48”x18” enclosure fits FPB19R/25R or FPB20S/26S
ANF-R60	60”x18” enclosure fits FPB-25R/29R/33R or FPB26S/32S/38S
ANF-L48	48”x 24”x 18” enclosure fits FPB-24L/30L/36L
ANF-L66	66”x24”x18” enclosure fits FPB-24L/30L/36L or (2) FPB-24L (end to end)
ANF-L74	74”x 24”x18” enclosure fits FPB-24L/30L/36L or (2) FPB-24L or (2) FPB-30L (end to end)
ANF-L90	90”x 24” x 18” enclosure FPB-24L/30L/36L or (2) FPB-24L or (2) FPB-30L (end to end) or (2) FPB-36L (end to end)
ANF-S48	42”x 42” x 18” enclosure fits FPB-19R/25R, FPB-20S/26S
ANF-S60	60”x 60”x 18” enclosure fits FPB-25R/29R/33R or FPB-26S/32S/38S

IF YOU CANNOT READ OR UNDERSTAND THESE INSTALLATION INSTRUCTIONS DO NOT ATTEMPT TO ASSEMBLE OR INSTALL THIS PRODUCT

INSTALLATION PRECAUTION:

These enclosures requires a minimum 18-square inches of cross ventilation per installed burner. Failure to provide proper ventilation can void the warranty.



Warning: For Outdoor Use Only



We recommend that our gas hearth products be installed and serviced by professionals who are certified in the U.S. by the National Fireplace Institute® (NFI) as NFI Gas Specialists.

PLEASE RETAIN THIS MANUAL FOR FUTURE REFERENCE

Round AnF Enclosure Assembly

NOTE

Two people are recommended to assemble all enclosures. It is also recommended to assemble the enclosure on a flat surface. The assembly of the AnF should be done at or near the location of the installation.

Contents of Enclosure

Remove all parts and make sure that you have received all necessary pieces.

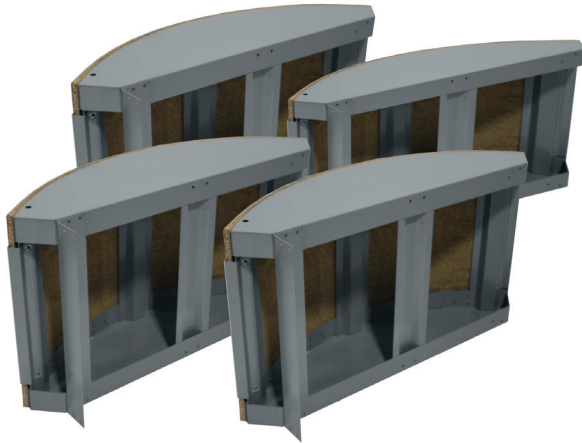

(4) Quarter Sections

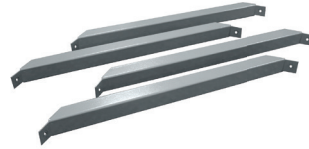

(4) 45° Pan Supports
*ANF-R42 and ANF-48 ONLY!



(2) Horizontal Pan Supports
*ANF-60 ONLY!



(4) MgO Boards

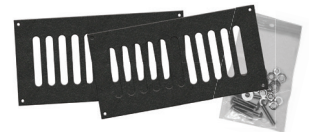

(1) Vent-Kit-6x12



Leveling Legs
AnF-R42 & AnF-R48: 4 Legs
AnF-R60: 8 Legs



(16) Self Tapping Screws



(16) Cement Board Screws

Fig. 1 Round AnF Contents

STEP 1

It is important to start the assembly process with the quarter sections upside-down. To make sure the quarter pieces are upside down, the bottom side has a nutsert (See Fig 2 - circle). **The nutsert needs to be facing upward on each quarter section.**

Each quarter section has a 90-degree inner flange on one side (See Fig. 2 - arrows). Butt the inner flange of one other quarter section to the non-flange side of another section (See Fig 3).

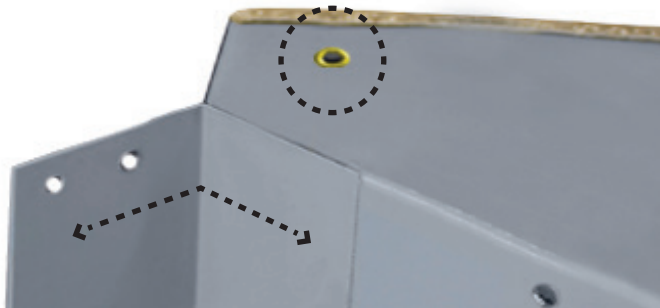

Fig. 2 Nutsert + 90° Flange

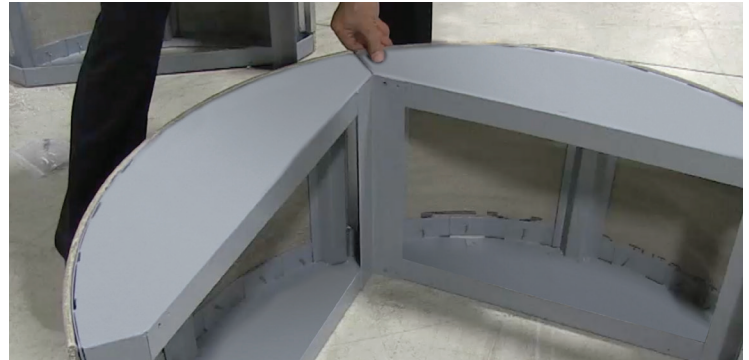

Fig. 3 Lining up Sides



After the two quarter sections are butt together, secure them with self-tapping screws; one into the inner hole at the top and one into inner hole at the bottom of the two sections (See Fig. 4).

Before you completely tighten the screws, check for squareness. Tighten screws.

Assemble the remaining sections the same manner.

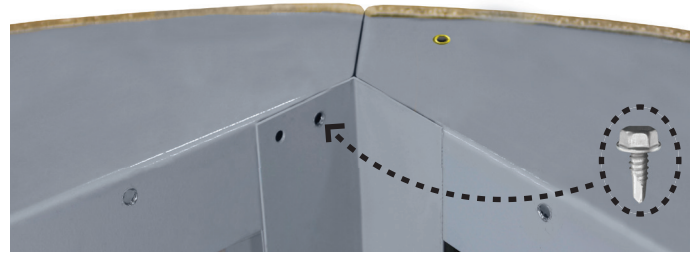

Fig. 4 Installing Self-Tapping Screws Into Quarter Pieces

STEP 2

While the assembled quarter sections are still upside-down, install the leveling legs. Locate the nutsert on the quarter sections (See Fig. 2). Take the leveling legs and screw them into the nutsert. The legs should be screwed in until there is 1-inch of clearance between the top of the leg and the quarter section (See Fig. 5).

NOTE: If you have an ANF-R60, you will have 8 leveling legs to install.

After the leveling legs have been installed, carefully flip the entire AnF unit over so that it is resting on the leveling legs.

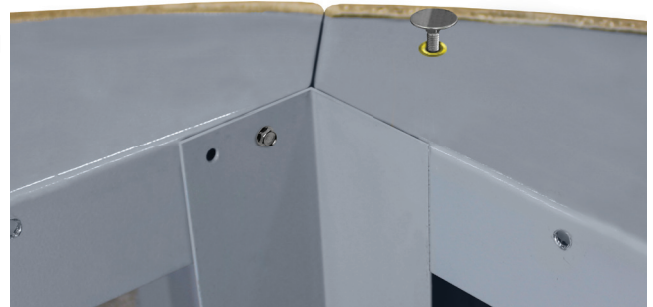

Fig. 5 Installing Leveling Legs Into Quarter Pieces

Once the AnF is turned over on the leveling legs, make any adjustments to the legs to make sure the unit is level. This must be done in the installation location.

STEP 3

Now that the quarter sections are put together, the feet are installed and the unit is turned over, the pan supports are ready to be installed. Please note that this is a **OPTIONAL** feature only used for specific Firegear Outdoor models. The chart below shows which Fire Pit Burner models fit in each model of AnF, and which ones require pan supports.

		16" ROUND	19" ROUND	20" SQUARE	25" ROUND	26" SQUARE	29" ROUND	32" SQUARE	33" ROUND
ANF-R42	Does this pan fit this AnF?	YES	YES	YES	NO	NO	NO	NO	NO
	Does it require supports?	YES	NO	NO	NO	NO	NO	NO	NO
ANF-R48	Does this pan fit this AnF?	NO	YES	YES	YES	YES	NO	NO	NO
	Does it require supports?	NO	YES	YES	NO	NO	NO	NO	NO
ANF-R60	Does this pan fit this AnF?	NO	NO	NO	YES	YES	YES	YES	YES
	Does it require supports?	NO	NO	NO	YES	NO	NO	NO	NO

Installing 45° Supports AnF-R42 & R48

Look at the AnF below and note how the pan supports are installed. There are two pre-drilled holes in the middle of each side (at the top - on the inside) (See Fig. 6). These holes are used for the 45° pan supports. Using the self tapping screws, use two screws per pan support and install them in the pre-drilled holes.

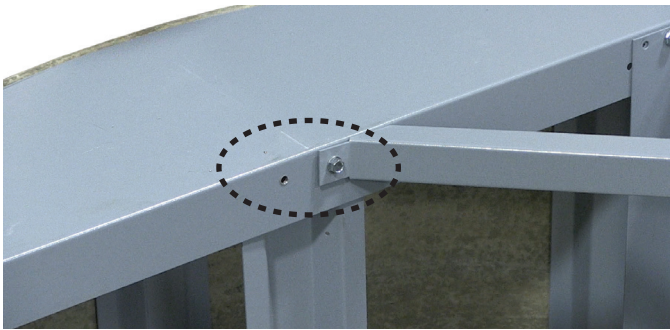
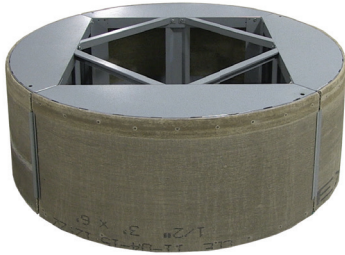

Fig. 6 Installing 45° Pan Supports

Installing Horizontal Supports AnF-R60

Look at the AnF below and note how the pan supports are installed. Each of the quarter sections have 4 holes at the top, 2 for each support to be installed in (See Fig. 7). To install, use the self tapping screws. Use four screws per pan support and install them in the pre-drilled holes.

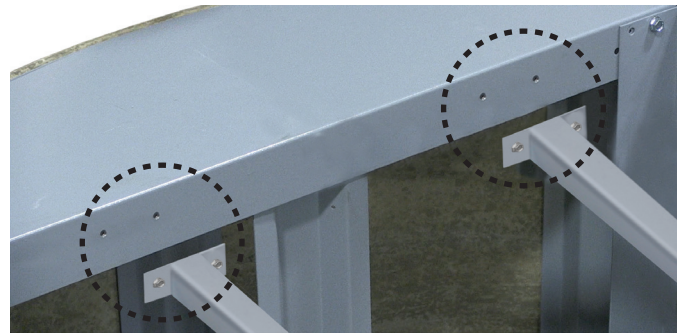
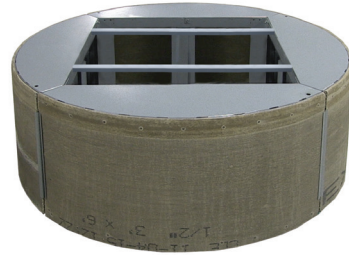

Fig. 7 Installing Horizontal Pan Supports

STEP 4

10mm MgO (Magnesium Oxide) Board is provided for the top surface. Each board comes with a pre-marked template based on the most popular Firegear burners for the size of AnF enclosures (See Fig. 8).

Place all (4) boards on top of the AnF. Mark where you need to cut following the template. For each piece you will need to cut on the inside (for the pan) and the outside (for the edge of the AnF). Once the pieces are cut, place them back on the top of the AnF and attach using the cement board screws provided (See Fig. 9). You can install the cement board screws anywhere there is metal underneath the MgO board top. (See Fig. 10).

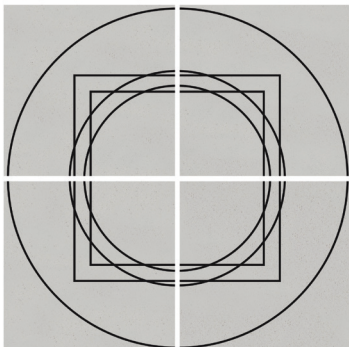

Fig. 8 Round MgO Top

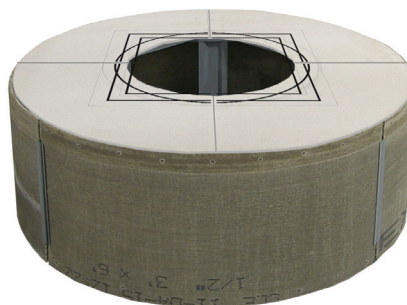

Fig. 9 Round MgO Top Installed

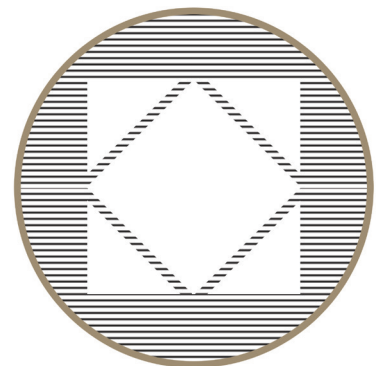
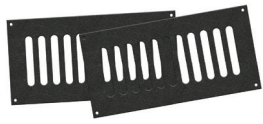

Fig. 10 Cement Board Screws

STEP 5

After the entire AnF is assembled, install the Vent-Kit-6x12. These vents are designed to be used with the AnF Series as well as universal vents for many other types of fire pit enclosures. Look at the contents provided to ensure you have received everything correctly.



(2) Vents



(12) Phillips Black
Pan Head Screw



(12) Stainless Steel
Nut



(2) Stainless Steel
Flat Washer

Install the vents on opposite sides of the enclosure to ensure cross flow ventilation. Cross flow ventilation is necessary to provide free flowing air to assist in keeping the enclosure dry and cool during operation of a fire pit.

Cut an rectangular opening 9.750" w x 3.750" h into on opposite sides of the enclosure. Center the vent over the cut out area ensuring the vent slots are clear of any obstruction. Mark the holes with a pencil or marker. Drill six 1/4" pilot holes, position the vent centered over the opening, insert a screw into the vent and enclosure at the same time and secure with washer and nut on the inside. Repeat the process until all six screws are securing each vent into place on both sides of the AnF enclosure (See Fig. 11).

NOTE: Before cutting the rectangular opening for your vents, be sure that you are not hitting one of the metal studs inside the AnF. The vents must be directly across from each other.

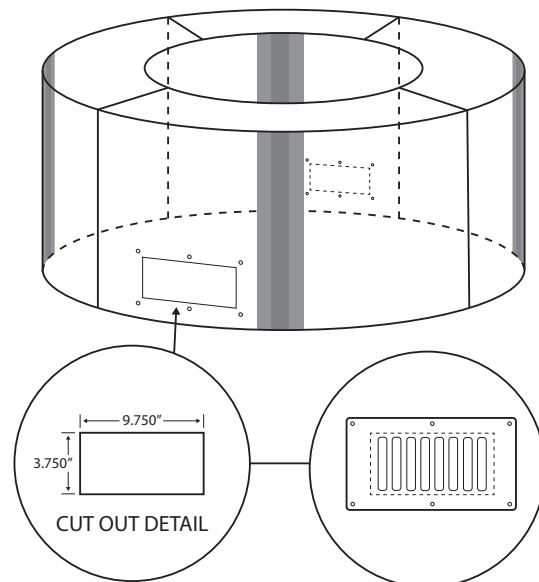

Fig. 11 Vent Cut Out Dimensions

Linear AnF Enclosure Assembly

NOTE

Two people are recommended to assemble all enclosures. It is also recommended to assemble the AnF enclosure on a flat surface. Assembly of the AnF should be done at or near the location of the installation.

Contents of Enclosure

Remove all parts and make sure that you have received all necessary pieces.

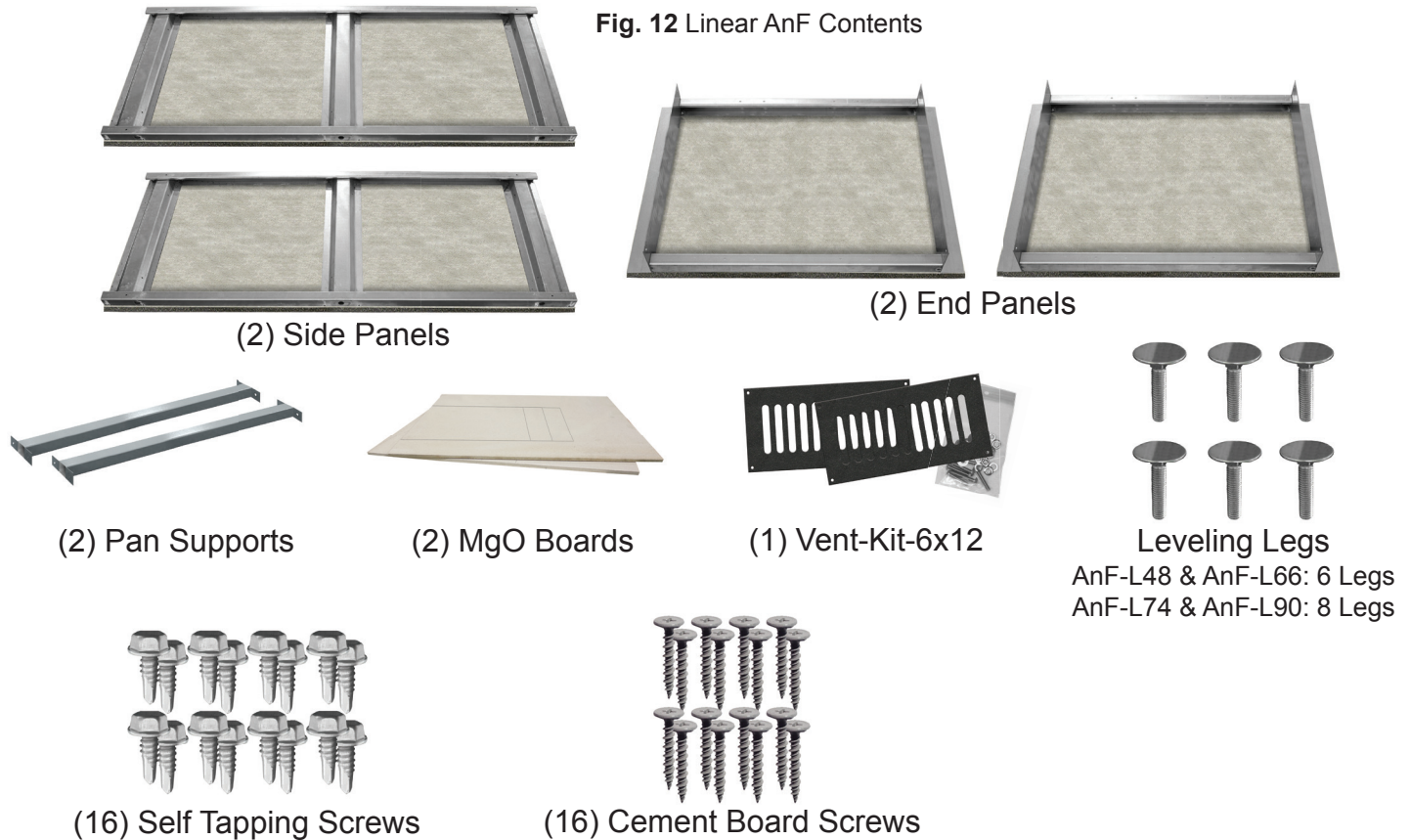

STEP 1

It is important to start the assembly process with the panels upside-down. Ensure the panels are upside down, the bottom side has a nutsert (See Fig 13 - Circle). **The nutsert needs to be facing upward on each panel.** Each panel also has a 90° inner flange on one side (See Fig. 13 - Arrows).

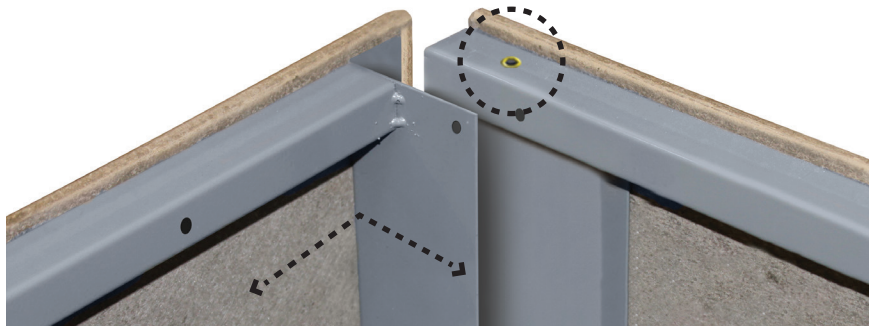

Fig. 13 90° Flange + Nutsert

Butt the inner flange of one of the panels to the non-flange side of another panel (See Fig. 13).



Fig. 14 Butting Ends Together

After the two ends are butt together, secure them with self-tapping screws; one into the inner hole at the top and one into inner hole at the bottom of the two panels (See Fig. 15).

Before you completely tighten the screws, check for squareness. Tighten screws.

Assemble the remaining sections the same manner.



Fig. 15 Installing Self-Tapping Screws Into Panel

STEP 2

While the panels are still upside-down, install the leveling legs. Locate the nutsert on the panels (See Fig. 11). Take the leveling legs and screw them into the nutsert. The legs should be screwed in until there is 1- inch of clearance between the top of the leg and the panel (See Fig. 16).

NOTE: If you have an ANF-74 or ANF-90, you will have 8 leveling legs to install.

After the leveling legs have been installed, carefully flip the entire AnF unit over so that it is resting on the leveling legs.

 **We strongly recommend two people when turning the AnF over.**

Once the unit is turned over on the leveling legs, make any adjustments to the legs to make sure the unit is level. This must be done on the installation location.

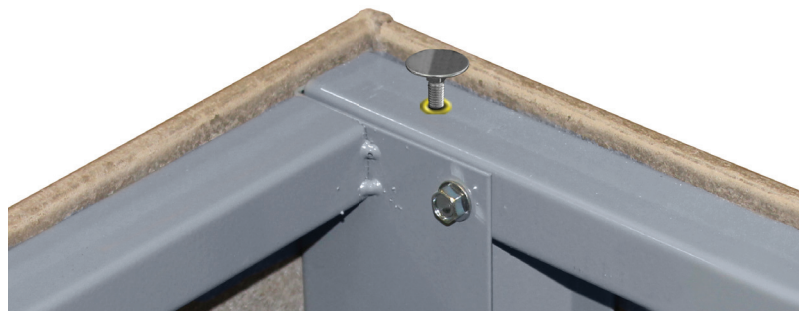

Fig. 16 Installing Leveling Legs Into Panels

STEP 3

Now that the panels are put together, the feet are installed and the unit is turned over, the pan supports are ready to be installed.

There are 2 pre-drilled holes on each END panel. See Figure 17 - it shows how the pan supports should be placed. Using the four pre-drilled holes, place the pan supports in their appropriate spots. Using the self tapping screws, install them in the pre-drilled holes on each side (See Fig. 18).



Fig. 17 Pan Support Placement

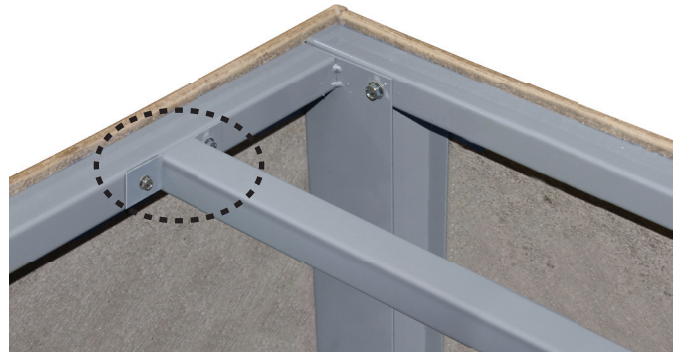

Fig. 18 Install Pan Supports

If you are using a Firegear Burner System, you MUST install the supports for the AnF. Every Linear Burner System requires supports.

STEP 4

10mm MgO (Magnesium Oxide) Board is provided for the top surface. Each board comes with a pre-marked template based on the most popular Firegear burners for the size of AnF enclosures (See Fig. 19).

Place both boards on top of the AnF. Mark where you need to cut following the template. For each piece you will need to cut on the inside in order to fit the burner type. Once the pieces are cut, place them back on the top of the AnF and attach using the cement board screws provided (See Fig. 20).



Fig. 19 Linear MgO Top

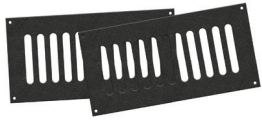

Fig. 20 Linear MgO Top Installed

In order to attach the cement board screw securely, you must screw them into the metal edges or supports of the AnF. Measure 1 inch from the edge of the AnF and drill into the metal through the MgO board. You can also drill into the supports that hold the pan in place.

STEP 5

After the entire AnF is assembled, install the Vent-Kit-6x12. These vents are designed to be used with the AnF Series as well as universal vents for many other types of fire pit enclosures. Look at the contents provided to ensure you have received everything correctly.



(2) Vents



(12) Phillips Black Pan Head Screw



(12) Stainless Steel Nut



(2) Stainless Steel Flat Washer

Install the vents on opposite sides of the enclosure to ensure cross flow ventilation. Cross flow ventilation is necessary to provide free flowing air to assist in keeping the enclosure dry and cool during operation of a fire pit.

Cut an rectangular opening 9.750" w x 3.750" h into on opposite sides of the enclosure. Center the vent over the cut out area ensuring the vent slots are clear of any obstruction. Mark the holes with a pencil or marker. Drill six 1/4" pilot holes, position the vent centered over the opening, insert a screw into the vent and enclosure at the same time and secure with washer and nut on the inside. Repeat the process until all six screws are securing each vent into place on both sides of the AnF enclosure (See Fig. 21).

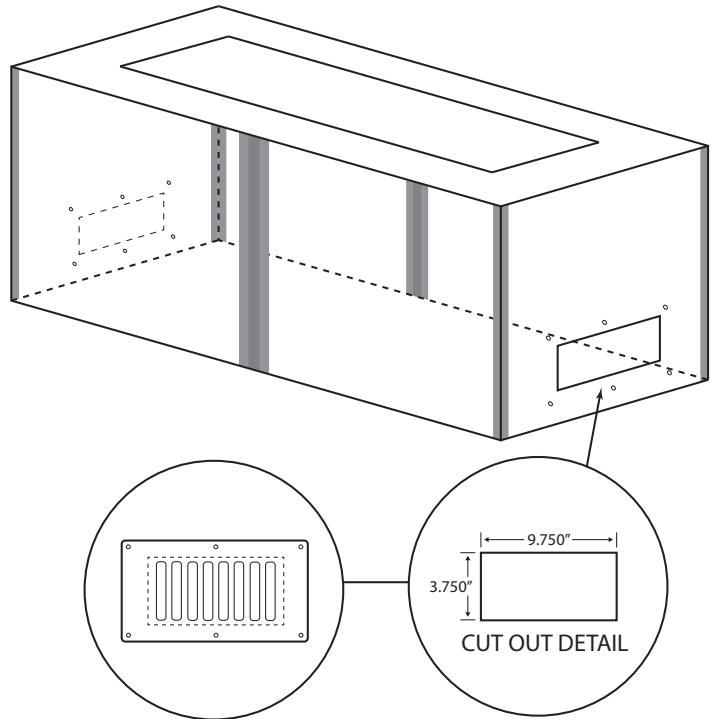

Fig. 21 Vent Cut Out Dimensions

NOTE: Before cutting the rectangular opening for your vents, be sure that you are not hitting one of the metal studs inside the AnF. The vents must be directly across from each other.

Square AnF Enclosure Assembly

NOTE

Two people are recommended to assemble all enclosures. It is also recommended to assemble the enclosure on a flat surface. The assembly of the AnF should be done at or near the location of the installation.

Contents of Enclosure

Remove all parts and make sure that you have received all necessary pieces.

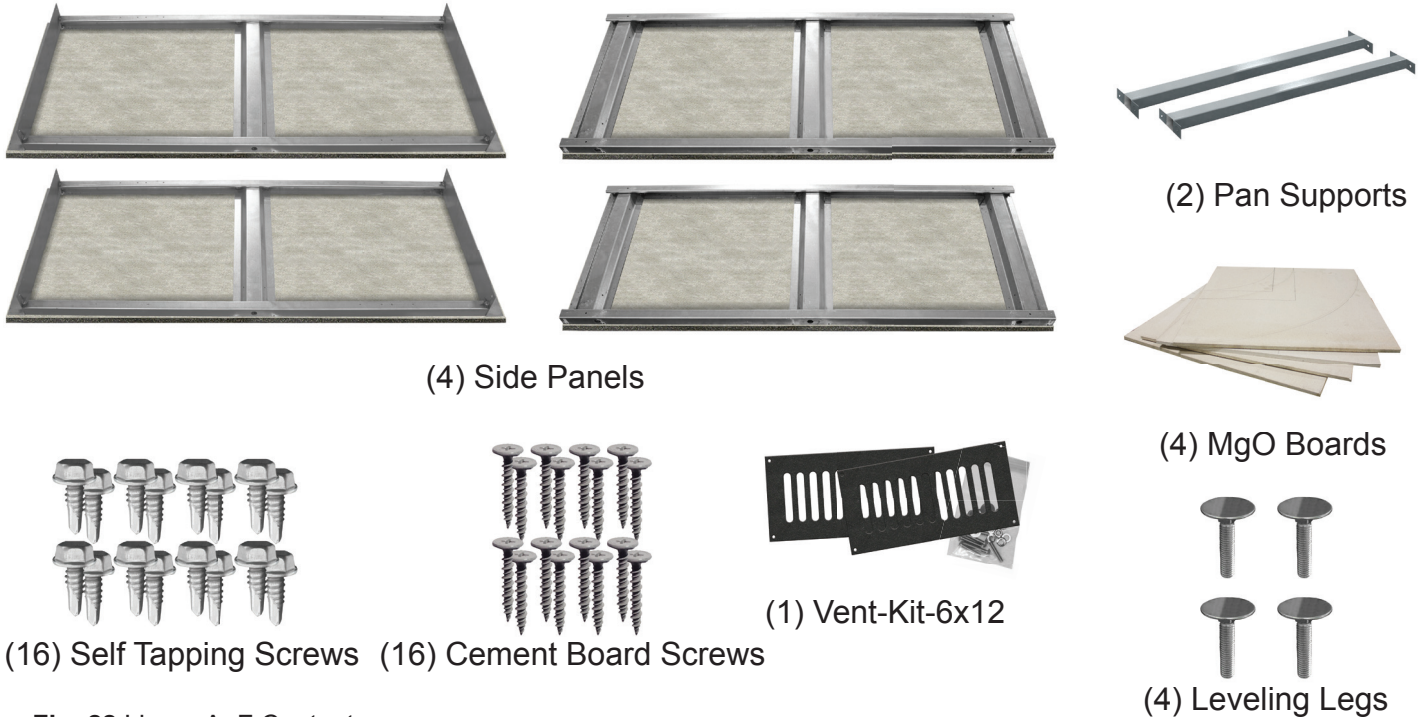
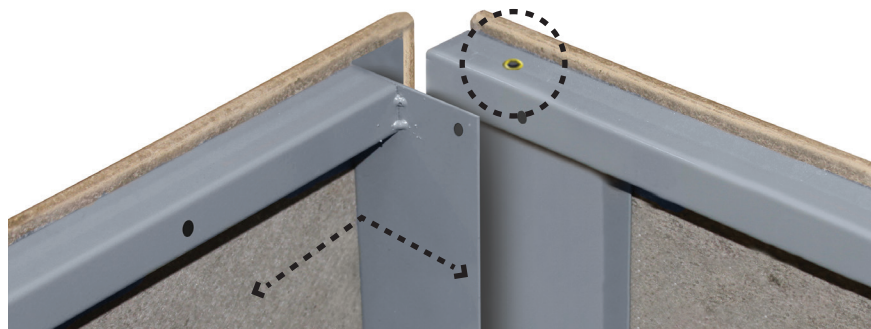

Fig. 22 Linear AnF Contents

STEP 1

It is important to start the assembly process with the panels upside-down. Ensure the panels are upside down, the bottom side has a nutsert (See Fig 23 - Circle). **That nutsert needs to be facing up on each panel.** Each panel also has a 90° inner flange on one side (See Fig. 23 - Arrows).



Butt the inner flange of one other panels to the non-flange side of another panel (See Fig. 24).



Fig. 24 Butting Ends Together

After the two ends are butt together, secure them with self-tapping screws; one into the inner hole at the top and one into inner hole at the bottom of the two sections (See Fig. 25).



Fig. 25 Installing Self-Tapping Screws Into Panel

Before you completely tighten the screws, check for squareness. Tighten screws.

Assemble the remaining panels the same manner.

STEP 2

While the panels are still upside-down, install the leveling legs. Locate the nutsert on the panels (See Fig. 11). Take the leveling legs and screw them into the nutsert. The legs should be screwed in until there is 1 inch of clearance between the top of the leg and the panel (See Fig. 26).

After the leveling legs have been installed, carefully flip the entire AnF unit over so that it is resting on the leveling legs.



We strongly recommend two people when turning the AnF over.

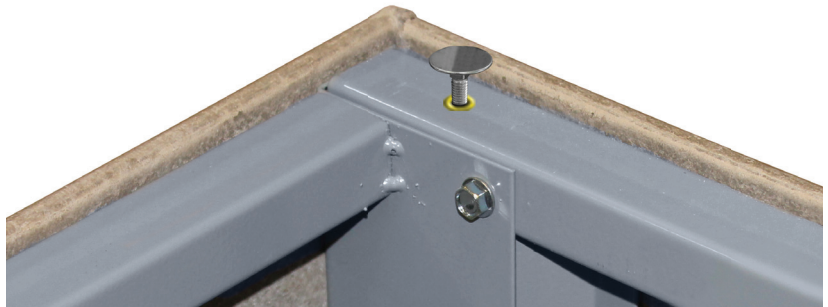

Fig. 26 Installing Leveling Legs Into Panels

Once the AnF is turned over on the leveling legs, make any adjustments to the legs to make sure the unit is level. This must be done in the installation location.

STEP 3

Now that the panels are put together, the feet are installed and the unit is turned over, the pan supports are ready to be installed.

There are pre-drilled holes on the panels. See Figure 27 - it shows how the pan supports should be placed. Using the two pre-drilled holes, place the pan supports in their appropriate spots. Using the self tapping screws, install them in the pre-drilled holes on each side (See Fig. 28).



Fig. 27 Pan Support Placement

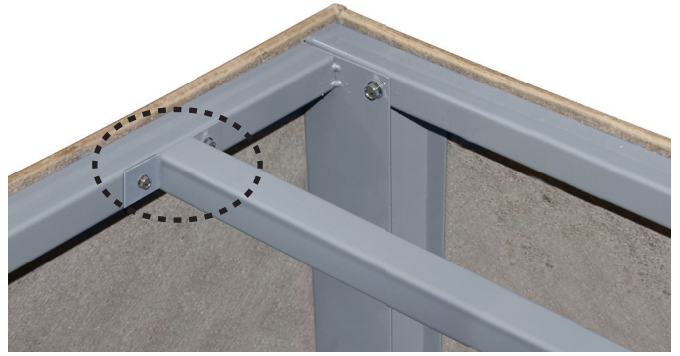

Fig. 28 Install Pan Supports

All square Fire Pit Burner Systems require supports.

STEP 4

10mm MgO (Magnesium Oxide) Board is provided for the top surface. Each board comes with a pre-marked template based on the most popular Firegear burners for the size of AnF enclosures (See Fig. 29).

Place both boards on top of the AnF. Mark where you need to cut following the template. For each piece you will need to cut on the inside in order to fit the burner type. Once the pieces are cut, place them back on the top of the AnF and attach using the cement board screws provided (See Fig. 30).

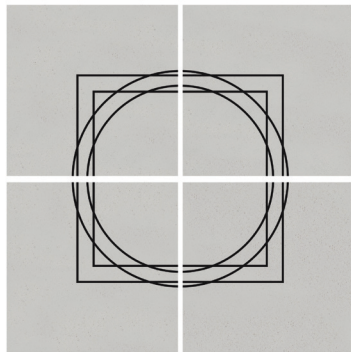

Fig. 29 Linear MgO Top

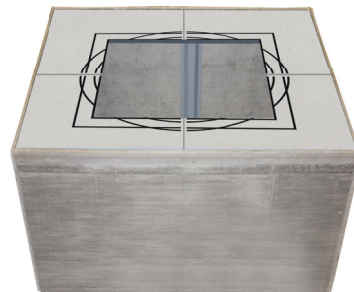
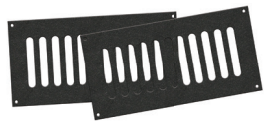

Fig. 30 Linear MgO Top Installed

In order to attach the cement board screw securely, you must screw them into the metal edges or supports of the AnF. Measure 1 inch from the edge of the AnF and drill into the metal through the MgO board. You can also drill into the supports that hold the pan in place.

Step 5

After the entire AnF is assembled, install the Vent-Kit-6x12. These vents are designed to be used with the AnF Series as well as universal vents for many other types of fire pit enclosures. Look at the contents provided to ensure you have received everything correctly.



(2) Vents



(12) Phillips Black
Pan Head Screw



(12) Stainless Steel
Nut



(2) Stainless Steel
Flat Washer

Install the vents on opposite sides of the enclosure to ensure cross flow ventilation. Cross flow ventilation is necessary to provide free flowing air to assist in keeping the enclosure dry and cool during operation of a fire pit.

Cut an rectangular opening 9.75" w x 3.75" h into on opposite sides of the enclosure. Center the vent over the cut out area ensuring the vent slots are clear of any obstruction. Mark the holes with a pencil or marker. Drill six 1/4" pilot holes, position the vent centered over the opening, insert a screw into the vent and enclosure at the same time and secure with washer and nut on the inside. Repeat the process until all six screws are securing each vent into place on both sides of the AnF enclosure (See Fig. 31).

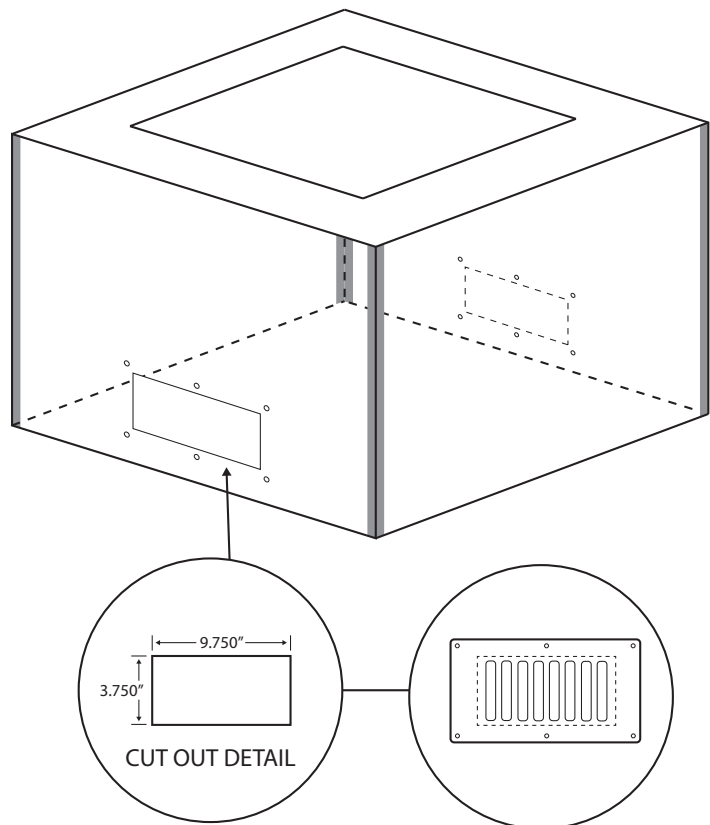

Fig. 31 Vent Cut Out Dimensions

NOTE: Before cutting the rectangular opening for your vents, be sure that you are not hitting one of the metal studs inside the AnF. The vents must be directly across from each other.

LIMITED WARRANTY

Skytech Products Group (Firegear Outdoors) hereby warrants to the end user that products will be free from material and workmanship defects that prevent safe and correct operation of the product. The warranty commences from date of sale to the end user for the following period:

Consumer/Non-Commercial Applications

Stainless Steel Components	5-Years
Gas Valve, Spark Ignitor & Electronic Parts	2-Years
G90 Galvanized Pans	3-Years
Gas Logs	5-Years
Glass Windshield	1-Year
Glass Media	5-Years
Remote Controls	5-Years
AnF Enclosure	5-Years
Lava Rock & Lava Stones	No Warranty

Commercial Applications

Stainless Steel Components	1-Year
Gas Valve, Spark Ignitor & Electronic Parts	1-Year
G90 Galvanized Pans	1-Year
Gas Logs	1-Year
Glass Windshield	1-Year
Glass Media	1-Year
Remote Controls	1-Year
AnF Enclosure	1-Year
Lava Rock & Lava Stones	No Warranty

End User must provide a bill of sale, canceled check, or payment record from the end user to verify purchase date and to establish warranty period. This Limited Warranty shall be valid and limited to the original purchaser only.

WARNING: Any modification to the product will void the warranty.

This Limited Warranty shall be limited to the repair and/or replacement of parts that have proven to be defective under normal use and service. Before returning any parts, contact our Technical Service Department for a Return Materials Authorization (RMA) number. All warranty claims must be made by the OEM / Distributor / Dealer account on behalf of the end user. You may contact Technical Service at (855) 498-8324.

All approved returned defects must be confirmed by our Technical Service Department. If the defect is confirmed and we approve the claim, we will replace such parts without charge. This warranty gives you specific legal rights, and you may also have other rights, which vary from state to state.

Travel, diagnostic cost, service labor to repair the defect and freight charges on warranty parts to and from the factory will be responsibility of the owner. We will not be responsible for labor charges and/or damage incurred in installation, repair, and replacement.

This Limited Warranty is voided if not assembled, installed and operated as intended. This Limited Warranty does not cover any defects due to accident, abuse, misuse, alteration, misapplication, vandalism, improper installation or improper maintenance or service, removal from the original location or re-installation into another location, or failure to perform normal and routine maintenance.

Damage due to severe weather conditions such as hail, hurricanes, earthquakes, tornadoes, discoloration due to over-heating, exposure to chemicals (including salt), either directly or in the atmosphere, or very high humidity, is not covered by this Limited Warranty.

There are no other express warranties except as set forth herein. For consumer applications, any applicable implied warranties of merchantability and fitness are limited in duration to the period of coverage of this Limited Warranty. Some states do not allow limitation on how long an implied warranty lasts, so this limitation may not apply to you.

For Commercial applications, the liability of Firegear Outdoors is limited to the express terms of this warranty. We expressly disclaim any and all implied warranties, including any warranties of fitness for a particular purpose or merchantability.

We are not liable for any special, indirect or consequential damages. Our maximum liability is limited to the purchase price of the purchased products. Some states do not allow the exclusion or limitation of incidental or consequential damages, so this limitation or exclusions may not apply to you.

We do not authorize any person or company to assume for it any other obligation or liability in connection with the sale, installation, use, removal, return, or replacement of its equipment; and no such representations are binding. REV. 3-2-16

