

Baustoffe

Sortimentkatalog



1919 - 2019
100 Jahre
Familienunternehmen

KORTE

Ihr Fachhändler in
3. Generation



Tel.: 05725 - 1015

Fax: 05725 - 7674

E-Mail: shop@korte-baustoffe.de

Unser Service und unsere Dienstleistungen für Sie !

- **Umfassende Fachberatung**
- **Verlegehinweise**
- **Großes Lagersortiment**
- **Kompetente Beratung vor Ort**
- **Aufmaßdienstleistungen**
- **Handwerkervermittlung**
- **Geräteverleih**
- **Außendienstbetreuung**
- **Lieferservie**

Frachten und Verpackungsmaterial

- Für Lieferungen werden **Frachtkosten** erhoben
- Bei uns erworbene **Paletten** werden zu 100% gutgeschrieben.
Tauschfähigkeit, bzw. guter Allgemeinzustand ist Voraussetzung.
Unsortierte Paletten werden nicht zurückgenommen.
- Für **Gitterboxen** wir eine Tauschgebühr erhoben.
- **Big-Bags** dürfen nach ASVO nur einmalig befüllt werden.
Rücknahme erfolgt ausschließlich zur Entsorgung.

Warenrücknahme

- Rücknahmen von Lagerartikeln nur nach Vereinbarung
Abzüglich 10% Bearbeitungsgebühr, zuzüglich Frachtkosten
- Big-Bag's (leer oder befüllt) sind von der Rückgabemöglichkeit ausgeschlossen
- Rücknahme von Bestell-, bzw. Streckenartikeln ist ausgeschlossen
- Sonderanfertigungen werden nicht zurückgenommen.

Unser Sortiment im Überblick

Tiefbau

- 4 Schüttgüter
- 5 Dekokies, Splitte und Gabionenschotter
- 6 HT-Rohre & Formteile
- 7 KG-Rohre & Formteile
- 8 KG 2000 / SN 10 Rohr
- 9 Schachtsystem DN 400
- 10 Drainagerohre, Formteile / Aquatub
- 11 Drainage-Kontroll- u. Spülschächte
- 12 PE-HD-Rohr / Schläuche
- 13 Tauchpumpen / Gartenpumpen
- 14 Schwengelpumpen / Wasserzapfsäulen
- 15 Regenwasserzisternen / Regentonnen
- 16 Betonwaren
- 17 Winkelstützen / Schalungssteine
- 18 Natursteine
- 19 Entwässerungsrinnen
- 20 Straßeneinläufe / Hofeinläufe
- 21 Schachtabdeckungen / Schachtmaterial

Innenausbau

- 40 Jackoboard / Fliesenzubehör
- 41 Fliesenlegerprodukte
- 42 Betonsanierung
- 43 XPS Dämmplatten
- 44 Innendämmung
- 45 Alternative Dämmung
- 46 Fußboden
- 47 Profiltechnik
- 48 Ständerwerkzargen
- 49 Gipskarton
- 50 Bauholz

Bedachung

- 61 Dachziegel
- 62 Trapezbleche
- 63 Lichtplatten
- 64 Hohlkammerplatten
- 65 Echtglas
- 66 Flachdach
- 67 Fassade
- 68 Dachrinnen

Hochbau

- 22 Bindemittel / Strahlsand
- 23 Mörtelprodukte / Putz
- 24 Transportbeton
- 25 Baustahl
- 26 Stahlträger / Winkelstahl / Schalung
- 27 Poroton / Ziegelstürze / Schalung
- 28 Kalksandsteine
- 29 Porenbetonsteine
- 30 Maurerbedarf
- 31 Schornsteine
- 32 Bauwerksabdichtung / Noppenbahnen
- 33 Bauchemie / Vergütungsmittel
- 34 Bauchemie / Schaum & Silikone
- 35 Bauchemie / Klebstoffe & Reparatur
- 36 Sanierputz / Schimmelsanierung
- 37 Verblendmauerwerk
- 38 Fensterbänke Granit/Marmor/Kunststein
- 39 Fensterbänke Aluminium

Bauelemente

- 51 Dachfenster & Bodentreppen
- 52 ZK-Türen FH-Klappen
- 53 FH-Türen Stahlzargen
- 54 Eckzargen MZ-Türen
- 55 Kellerfenster
- 56 Gitterroste
- 57 Lichtschächte
- 58 Nebentüren
- 59 Garagentore & Antriebe
- 60 Zäune

Alle Angaben zu den Katalogprodukten beruhen größtenteils auf jahrzehntelange Erfahrung uns üblicher Vorgehensweisen.

Tiefgehende Produkt- und Verarbeitungsinformationen erhalten Sie gerne von uns oder auf den jeweiligen Internetseiten der Hersteller.

Legende

Lagerartikel = ●

Artikel auf Bestellung = ○

Schuttgüter



Basalt Steinmehl
0-2 mm in Mini-Bag's



Basalt Splitt
2-5 mm, 11-16 mm



Basalt Schotter
30 - 60 mm



Basalt Wasserbausteine
90-250 mm



Moräne Rundkiesel
30-60 mm, 45-150 mm



Kies 0-8, 0-16 mm



Leinekies 2-8 mm



Leinekies 8-16 mm



Leinekies 16-32 mm



Mutterboden gesiebt



Mauersand

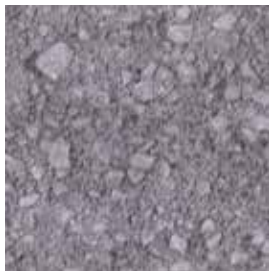

Mineralgemisch



Pflastersplitt 0-5 mm



Sand 0-2 mm



Spiel-/ Fugsand



Geotextil Filtervlies
Rollenbreite 100 und
200 cm, auch im
Anschnitt



Wasserdurchlässige
Folie PP-Bändchen-
gewebe im Anschnitt,
Rollenbreite 150 cm



Big Bag / Mini Bag

Alle Sorten sind auch in Großverpackung – Neudeutsch Big Bag's genannt – lieferbar ! Die Preise für Lieferungen im Big-Bag verstehen sich immer per Tonne. Der Big-Bag ist im Preis enthalten und muß nicht zusätzlich bezahlt werden. **Neu** sind die Mini-Bag's, mit Inhalten á 500kg. Hierfür gilt ein Stückpreis (ganzer Sack).



„Harzer Brocken“
BASALT-Felsen
bis 120 cm Ø



Gletscher-Findlinge
bis 100 cm Ø



Dekokies & Splitt, Gabionenschotter



Basalt



Grauwacke



Möhnesee



Moräne bunt



Rosso Verona



Ruby



Yellow Sun



Ice Grey



Carrara
25 - 40 und 40 - 60 mm



Gletscher bunt
250 - 400 mm



Gletscher grau
30 - 60 mm



Moränenkiesel vom
Oberrhein 30 - 60
und 45 - 150 mm



Quarkies
8 - 16, 15 - 30 und
30 - 60 mm



Basalt
8 - 16 und 16 - 32 mm



Canadian Slate grau-
blau
30 - 60 mm



Granitsplitt grau
8 - 16 mm



Granitsplitt rotbunt
8 - 16 und 16 - 22 mm



Sienna Giallo
16 - 25 mm



Grauwacke
14 - 25 mm



Porphyr rot
8 - 16 mm



Yellow Sun
8 - 16 und 16 - 32 mm





Icy Blue
16 - 32 mm



Imperial Slate
20 - 60 mm



Latte Macchiato
16 - 32 mm

HT-Hausabflussrohr & Formteile aus PP			nach DIN 1451 u. 4102/131		Heißwasserbeständig bis 90°			
			Einheit	Durchmesser DN				
				40	50	75	110	
Rohr	0,25	m	Stück	o	•	•	•	
	0,5	m	Stück	o	•	•	•	
	1	m	Stück	o	•	•	•	
	2	m	Stück	o	•	•	•	
Bogen	15°		Stück	o	•	•	•	
	30°		Stück	o	•	•	•	
	45°		Stück	o	•	•	•	
	67°		Stück	o	•	•	•	
	87°		Stück	o	•	•	•	
Abzweig 45° + 87° (DN 75/75 auch 67°)								
	/ 40		Stück	o	•	•	•	
	/ 50		Stück		•	•	•	
	/ 75		Stück			•	•	
	/ 110		Stück				•	
Reduzierstück								
	/ 40		Stück		•			
	/ 50		Stück			•	•	
	/ 75		Stück				•	
Überschiebmuffe			Stück	o	•	•	•	
Muffenstopfen			Stück	o	•	•	•	
Reinigungsrohr			Stück		•	•	•	
Anschl. Steinzeugrohr:								
Dichtung			Stück	o	•	•	•	
Gummimanschette			Stück		•			
Schellen, verzinkt					50	75	110	
	mit Schlagstift	Stück			•	•	•	
	mit Gewindestift M8x80mn	Stück			•	•	•	
	Schallgedämmt	Stück			•	•	•	
Gleitmittel			250 gr.	Tube	<input type="checkbox"/>			
Tangit			Kleber	125 gr	Tube	<input type="checkbox"/>		
	Reiniger	125 ml	Flasche	<input type="checkbox"/>				
Rückstauverschluß					100	125	150	
	Einfach	Stück			•	o	•	
Führend in Entwässerung	Doppelverschluß	Stück			•	o	•	

KG - Rohre SN4 & Formteile aus PVC-U			Rohr Formteile		DIN EN 13.476	8061	
					DIN EN 1401-1 und	Teil 3	
			Einheit	Durchmesser DN			
			110	125	160	200	
Rohr	0,5	m	Stück	•	•	•	•
	1	m	Stück	•	•	•	•
	2	m	Stück	•	•	•	•
	5	m	Stück	•			
Bogen	15°		Stück	•	•	•	•
	30°		Stück	•	•	•	•
	45°		Stück	•	•	•	•
	67°		Stück	•			
	87°		Stück	•	•	•	•
Abzweig 45° + 87° *			<i>* ... 87° nur in 110/110 + 125/125 am Lager!</i>				
	/ 110		Stück	•	•	•	0
	/ 125		Stück		•	•	0
	/ 160		Stück			•	0
	/ 200		Stück				•
Reduzierstück							
	/ 110		Stück		•	•	
	/ 125		Stück			•	
	/ 160		Stück				•
Überschiebmuffe			Stück	•	•	•	0
Muffenstopfen			Stück	•	•	•	0
Reinigungsrohr			Stück	•	•	•	
Anschl. Steinzeugrohr:							
KGUSM	Muffe		Stück	•	•	•	•
KGUS	Spitzende		Stück	•	•	•	•



KG - Rohre SN4 & Formteile aus PVC-U			Rohr Formteile		DIN EN 13.476	8061	
					DIN EN 1401-1 und	Teil 3	
			Einheit	Durchmesser DN			
			250	315	400	500	
Rohr	1	m	Stück	0	0	•	0
	2	m	Stück	0	0	0	0
	5	m	Stück	0	0	0	0
Bogen	15°		Stück	0	0	0	0
	30°		Stück	0	0	0	0
	45°		Stück	0	0	0	0
	87°		Stück	0	0	0	0
Abzweig 45° + 87°			<i>kleinere Abzweige, auf DN 110/125/160/200 auf Anfrage</i>				
	/ 250		Stück	0	0	0	0
	/ 315		Stück		0	0	0
	/ 400		Stück			0	0
	/ 500		Stück				0
Reduzierstück							
	/ 200		Stück	0			
	/ 250		Stück		0		
	/ 315		Stück			0	
	/ 400		Stück				0
Überschiebmuffe			Stück	0	0	0	0
Muffenstopfen			Stück	0	0	0	0

KG 2000 SN 10

Rohre & Formteile aus PP

Zulassungs Nummer Z-42. 1-282/283 Anlehnung
an die DIN EN 1852-1, DN 110-200

	Einheit	Durchmesser DN				
		110	125	160	200	
Rohr	0,5 m	Stück	•	•	•	0
	1 m	Stück	•	•	•	0
	2 m	Stück	•	•	•	0
	5 m	Stück	0	0	0	0
Bogen	15°	Stück	•	•	•	0
	30°	Stück	•	•	•	0
	45°	Stück	•	•	•	0
	67°	Stück	0	0	0	
	87°	Stück	0	0	0	
Abzweig	/ 110	Stück	•	•	•	0
	/ 125	Stück	0	•	0	0
	/ 160	Stück	0	0	•	0
	/ 200	Stück	0	0	0	0
Reduzierstück	/ 110	Stück		•	•	
	/ 125	Stück			•	
	/ 160	Stück				0
Überschiebmuffe	Stück	•	•	•	0	
Muffenstopfen	Stück	•	•	•	0	
Reinigungsrohr	Stück		0	0	0	0



remmers Stop Aq

Hauff
Mauerdurchführung



Dauerplastische Dichtung von Kabeln
Leitungen und Rohren, Gasdicht
Unter Wassereinwirkung expandierend
Druckwassericht bis 0,3 Bar
Haftet auf nassen und trockenem Untergrund

310 ml

KG - Fix

DN 110

•



Hauff

Bauherrenpakete

Mehrsparten- und Einspartenhouseinführungen
für Gebäude mit und ohne Keller



Ostendorf Schacht
DN 400 gemäß
**DIN EN
13598**

Multifunktionaler
Kontrollschacht

Schachtsystem 400



Abdeckung
Kl. A 15
PP (Kunststoff)



Abdeckung
Kl. B 125
PKW-befahrbar

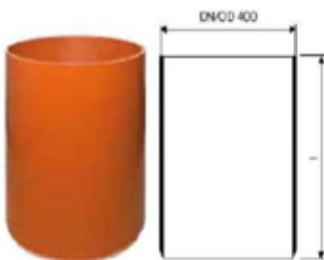

Steigrohr
Schachtverlängerung
100 cm



zur weiteren Verlängerung:
KG-Rohr DN 400
mit Steckmuffe
100 cm

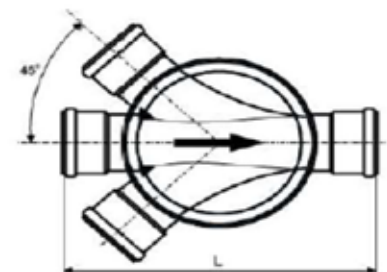
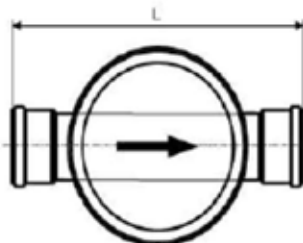

Schachtboden "Typ Gerade"		
DN 160	Anschlüsse	DN 110
•		•

Schachtboden "Typ RML"		
DN 160	Anschlüsse	DN 110
•		•

Sirobau S300

Kontroll- und Spülschacht aus PE-HD
Im Modulschacht enthalten: 1 Verschlußstopfen, KST-Deckel

HEGLER



Modulschacht S300 mit Sandfang Nutzhöhe: 70 cm	<input type="checkbox"/>
---	--------------------------



Sirobau Drainrohr DN100 2,50m Stück	<input type="checkbox"/>
---	--------------------------



Siroplast-K Teilsickerrohr DN 100 mit Muffe 3,00m Stück	<input type="checkbox"/>
--	--------------------------

Modulschacht - Verlängerung 63 cm	<input type="checkbox"/>
123cm	<input type="checkbox"/>

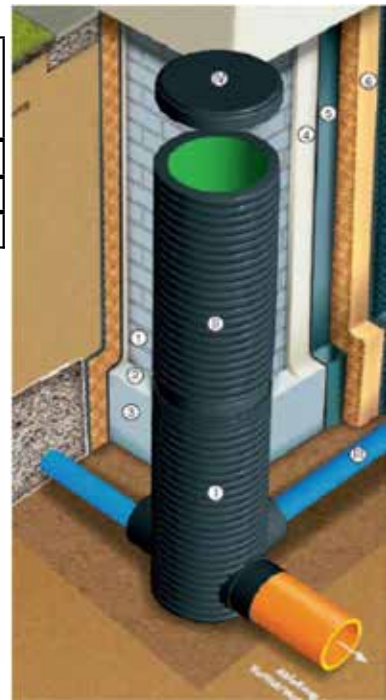
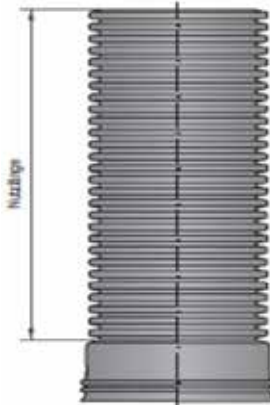

Hochbau / Ingenieurbau
Dachabdeckung und Entwässerung



Wasserhaushalt
Kanalisation



Regelausführung einer Gebäudedränge
nach DIN 4095

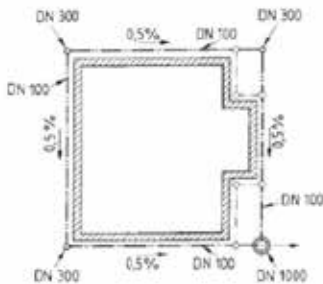

Beispiel: Gebäudegrundriss mit Dränanlage



Formteile

Verschlußstopfen	<input type="checkbox"/>
Anschlußstücke	
auf KG 110	<input type="checkbox"/>
auf Drain + KG 160	<input type="checkbox"/>
auf Drain DN 100	<input type="checkbox"/>
auf Siroplast DN 100	<input type="checkbox"/>

Abdeckungen

	Kunststoff Standard	<input type="checkbox"/>
	Klasse B Guss Kl. B mit Kunststoffschräge zur Lastverteilung	<input type="checkbox"/>

Sensorgesteuerte Klarwasser-Schachtpumpe

Promax ClearDrain

11000 L/h	<input type="checkbox"/>	14000 L/h	<input type="checkbox"/>
-----------	--------------------------	-----------	--------------------------

Kabelschutzrohr

DN 50	DN 63	DN 75	DN 110	DN 160
<input type="checkbox"/>	<input type="checkbox"/>	<input type="checkbox"/>	<input type="checkbox"/>	<input type="checkbox"/>



Hekaplast-R, 50m Ring

Drainagerohre

DN 50 DN 65 DN 80 DN 100 DN 125 DN 160

Eurodrain-Rohr

Anschnitt

50 m Ring
50 m Ring ungeschlitz
200 m Ring (50+65) 100m Ring (80+100)



•	•	•	•		
•	•	•	•	•	•
o	o	o	o		
o	o	o	o		

Eurodrain-Rohr DN 100 KOKOS

Anschnitt

50m Ring (160er 45m Ring)



DN 100

			•		
o	o	o	•	o	o

Sirobau-Drainrohr DN 100

2,50 m lang - Stangen-Drainrohr -



DN 100

			•		
--	--	--	---	--	--

Siroplast-K DN 100

3,00 m lang - Teilsickerrohr-

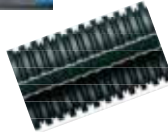

DN 100

			•		
--	--	--	---	--	--

Drainrohr - Formteile

DN 50 DN 65 DN 80 DN 100 DN 125 DN 160

Abzweig 45°
Schrägstück

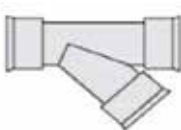

Abzweig 90°

T-Stück



Verbindungs-
muffe



Bogen 90°

/ Winkelstück

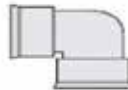

Anschlussstück
langer Hals



Endverschluss

/ Verschlussstopfen ohne Abb.

HEGLER

Auslaufstück

/ Froschklappe



Drain auf KG 110
Übergangsstück



•	•	•	•	o	o
---	---	---	---	---	---

•	•	•	•	o	o
---	---	---	---	---	---

o	o	•	•	o	o
---	---	---	---	---	---

•	•	•	•	o	o
---	---	---	---	---	---

•	•	•	•	o	o
---	---	---	---	---	---

65 / 50	80-100/50	80-100/65	100-125/80	125-160/100	160/80
o	•	•	•	•	o

o	o	•	•	o	•
---	---	---	---	---	---

			•		
--	--	--	---	--	--

Rohre für den Graben und Wegebau

DN 300 DN 400 DN 500

Aquatub RW

mit Muffe + Dichtungsring
3,00 m lang



•

•



•



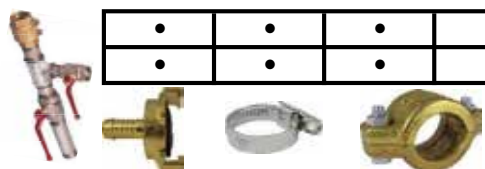



Trinkwasserrohr PE-HD - schwarz -		1/2"	3/4"	1"	1 1/4"	1 1/2"
  		Da = 20mm Di = 16mm	Da = 25mm Di = 20mm	Da = 32mm Di = 25mm	Da = 40 mm Di = 32 mm	Da = 50mm Di = 40mm
	50 m Ring	○	●	●	○	○
	100 m Ring	○	○	○	○	○
PE - Rohrverbindungen aus Messing oder Kunststoff						

Saugschlauch -vakuumfest-		3/4"	1"	1 1/4"	1 1/2"
 <p>Mit stabiler Spirale, flexibel, innen glatt, leicht zu handhaben</p>	25 m Anschnitt	●	●	●	●
		●	●	●	●
					

Tropfschlauch "Rain Bird"		16 x 1,2 mm			
2,3 L / Stunde / 33 cm	100 m	●			

Wasserschlauch "Torsino"		1/2"	3/4"		
 	25 m	●	●		
	50 m	●	●		
					

PVC Flachschauch (aufrollbar)		1 1/2"	2"
 	25 m	●	●
	C-Kupplungen	●	●
	C-Ablaufschlauch 10 m	●	●
			

Spiralschlauch (Teichschlauch)		1/2"	3/4"	1"	1 1/4"	1 1/2"
 	Ø Innen:	13 mm	19 mm	25 mm	32 mm	40 mm
	25 m	●	●	●	●	●
	Anschnitt	●	●	●	●	●
					2"	3"
				50 mm	75 mm	
				25 m Anschnitt	●	●
				●	●	

Schwimmbadschlauch "Poolflex"		43 x 50 mm		
25 m	●			
Anschnitt	●			

Klarwassertauchpumpen

	ProMaxClear Drain 7000	<input type="checkbox"/>
	400 W, 7m Förderhöhe, Schwimmer	
	ProMaxClear Drain 11000	<input type="checkbox"/>
	650 W, 8m Förderhöhe, Sensor	
	ProMaxClear Drain 14000	<input type="checkbox"/>
	1000W, 12m Förderhöhe, Sensor	



Druckstutzen 1 1/4",
Sensor ermöglicht den
Einbau in Schächte ab 25cm Ø



Schmutzwassertauchpumpen

	ProMaxMud Drain 7000	<input type="checkbox"/>
	400 W, 5m Förderhöhe, Schwimmer	
	ProMaxMud Drain 11000	<input type="checkbox"/>
	650 W, 7m Förderhöhe, Schwimmer	
	ProMaxMud Drain 14000	<input type="checkbox"/>
	1000 W, 11m Förderhöhe, Schwimmer	

ProMaxMud Drain 20000	<input type="checkbox"/>
950 W, 10m Förderhöhe, Schwimmer	
ProMaxMud Drain 25000	<input type="checkbox"/>
1200 W, 11m Förderhöhe, Schwimmer	
ProMaxMud Drain 30000	<input type="checkbox"/>
1500 W, 12m Förderhöhe, Schwimmer	



Gartenpumpen

	ProMax Garden Classic 3000	<input type="checkbox"/>
	550 W, 41m Förderhöhe	
	ProMax Garden Classic 4500	<input type="checkbox"/>
	850W, 44m Förderhöhe	

ProMax Garden 3500	<input type="checkbox"/>
900 W, 40m Förderhöhe	
ProMax Garden 5000	<input type="checkbox"/>
1300 W, 50m Förderhöhe	
ProMax Garden 6000	<input type="checkbox"/>
1400 W, 60m Förderhöhe	

Integriertes Rückschlagventil - Integrierter Vorfilter

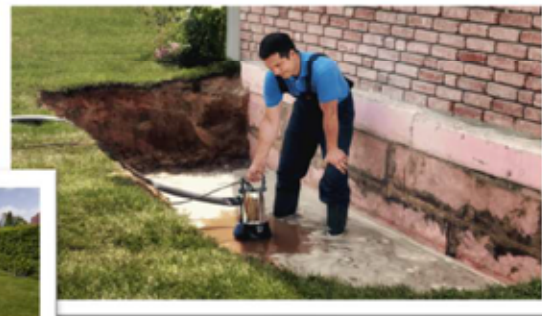

Hauswasserautomaten

ProMax Garden Automatic 3500	<input type="checkbox"/>
900 W, 40m Förderhöhe	
ProMax Garden Automatic 3500	<input type="checkbox"/>
1100 W, 45m Förderhöhe	
ProMax Garden Automatic 5000	<input type="checkbox"/>
1300 W, 50m Förderhöhe	
ProMax Garden Automatic 6000/5	<input type="checkbox"/>
1400 W, 60m Förderhöhe	



Tiefbrunnenpumpe

ProMax Pressure Well 6000/8	<input type="checkbox"/>
1200 W, 57m Förderhöhe	
8-stufiges Pumpenlaufwerk, Thermoschutzschalter	
Automatische Wasserversorgung, Einbau in Schächte mit Ø 10 cm	

Tauchdruckpumpe

ProMax Pressure 6000/8	<input type="checkbox"/>
1200 W, 57m Förderhöhe	
8-stufiges Pumpenlaufwerk, Thermoschutzschalter	
Aufstellung senk- oder waagrecht, Standfuß, 30m Stromkabellänge	



Schwengelpumpen



Zubehör



Ledermanschette



Rundflansch



Kolben, komplett

Pumpe grün
Höhe 44cm
mit/ohne Pumpenständer
oder auch
mit Seitenflansch zur
Wandmontage

Pumpe schwarz
"Nostalgiepumpe"



Nasenstechventil



Doppelter Pumpenstock

für 1" Motor- oder 1 1/4" Handpumpe

Rammfilter

ca. 115cm, 32mm (1 1/4")

mit Messinggewebe



Stahlmuffe



Schlagkopf

Verlängerungsrohr

32mm (1 1/4")

150 cm

100 cm

30 cm



Wasserzapsäulen



Granitoptik
dunkel



Edelstahl



Holzoptik



Granitoptik hell

Regenwassernutzung



Komplettpakete für
Hausnutzung und/oder
Gartenbewässerung

Tankgrößen von 1.600 - 15.000 Liter



Flachtanks
von 1.500 bis 15.000 Liter



Externe Filtertechnik - 100 % Wasserausbeute



Universal-Filter 3

Versickerungssysteme

Herkules Tank

1600 Liter

für Ober- und
Unterirdische
Montage geeignet



Regentonnen



Modern Line

Exklusiv Line



Classic Line

Basic Line

Betonwaren



Rasenbord		
mit Nut & Feder		
5 x 15 x 100 cm	grau	anthrazit
5 x 25 x 100 cm	•	•
5 x 30 x 100 cm	•	•
mit Fasse		
6 x 25 x 100 cm	•	•



Tiefbord mit Fasse		
8 x 20 x 100 cm	•	•
8 x 25 x 100 cm	•	•
8 x 30 x 100 cm	•	•
10 x 30 x 100 cm	•	•



Palisaden		
10 x 20 x 40 cm	•	•
10 x 20 x 70 cm	•	•



Winkelstufen	
18 x 32 x 100 cm	grau
	•



Blockstufen	
16 x 35 x 100 cm	grau
	•

Terrassenplatte	
40 x 40 x 5 cm	•
Smartton XXS "Amiata"	
grau-anthrazit	



Antikpflaster	
22,5 x 15 x 6 cm	
Tumbelton "Kilimanjaro"	•
Muschelkak	•



Terrassenplatte	
40 x 60 x 4 cm	•
Luna "Muschelkalk"	



Antikpflaster	
21 x 14 x 8 cm	
Steinhuder Antik	
Anthrazit	•



Gestaltungspflaster	
20 x 30 x 8 cm	
Premiton XL Linea	
Grau-Anthr.	•



Betonplatten		
50 x 50 x 5 cm	grau	anthrazit
25 x 50 x 5 cm	•	•
40 x 40 x 4 cm	•	•

30 x 30 x 4 cm	•
----------------	---



Rechteckpflaster	
20 x 10 x 8 cm	
grau	•
anthrazit	•
rot	•

Rasengitter	
60 x 40 x 8 cm	
	•



L-Steine

Normalbeton C20/25

Bedarf: 2,5 St./lfm



	VPE	Gewicht	
30 x 40 x 20 x 6	40	25	o
40 x 40 x 25 x 8	24	43	•
50 x 40 x 32 x 8	16	50	•
60 x 40 x 40 x 8	12	70	o
80 x 40 x 45 x 8	8	100	o

Höhe x Baubreite x Tiefe (Fußlänge)

Winkelstützen

Sichtbeton C30/37

D = 10 cm

Kanten gefast



50 x 50 x 50	8	115	O Lieferzeit ca. 1 Woche
50 x 100 x 50	4	230	
60 x 50 x 50	8	125	
60 x 100 x 50	4	250	
80 x 50 x 50	8	150	
80 x 100 x 50	4	300	
100 x 50 x 60	8	185	
100 x 100 x 60	4	370	
120 x 50 x 65	4	210	
120 x 100 x 65	2	420	
140 x 50 x 90	4	240	
140 x 100 x 90	2	480	
150 x 50 x 90	4	300	
150 x 100 x 90	2	600	
160 x 50 x 90	4	320	
160 x 100 x 90	2	640	
180 x 50 x 100	2	350	
180 x 100 x 100	1	700	
200 x 50 x 110	2	375	
200 x 100 x 110	1	750	

Einfriedigungen

Teich/Pooleinfassungen

Stütz- u. Trennwände



Sichtschutzwände

Kellerwände

Mauerwerke

Fahrhilfen

Getreidelager



Schalungssteine

1 Stück Endstein je Steinlage enthalten

Bedarf: 2 St./lfm // 8 St./m²

** nur VPE / volle Paletten lieferbar

50 x 11,5 x 25	90	16	•
50 x 17,5 x 25	60	23	•
50 x 24,0 x 25	50	26	•
50 x 30,0 x 25	40 **	28	○
50 x 36,5 x 25	30 **	33	○

Natursteine

Natursteinpflaster geschlagen/gespalten

Granit	4 / 6	9 / 11	15 / 17
hellgrau	•	•	•
dunkelgrau	•	•	
gelb		•	
Basalt		•	
schwarz		•	
Sandstein			
bunt	•	•	



Granit hellgrau
gesägt und feingestockt

10x10x8 cm	20x10x5 cm
•	•



Sandstein bunt

5-8 x 20 - 100cm
•

Palisaden / Stelen

	hellgrau	dunkelgrau
12 x 12 x 30 cm gespitzt	•	•
12 x 12 x 50 cm	•	•
12 x 12 x 75 cm	•	•
12 x 12 x 100 cm	•	•
12 x 12 x 150 cm	•	
15 x 15 x 250 cm	•	

Borsteine

	hellgrau	dunkelgrau
6 x 20 x 50 cm	•	
6 x 20 x 100 cm	•	•
8 x 20 x 50 cm	•	
8 x 20 x 100cm	•	•
10 x 25 x 50 cm	•	
10 x 25 x 100 cm	•	

Blockstufe

100 x 35 x 15 cm
gesägt & geflammt

Granit		Basalt	Sandstein
hellgrau	dunkelgrau	schwarz	grau-bunt
•	•	•	•



Mauersteine



	Granit hellgrau	Sandstein grau - bunt			
	Mauerstein	Knacker	Binder	Hammerrechte	
	•	•	•	•	
Höhe x	15 x	10 - 20 x	10 - 20 x	16 x	12 x
Breite x	12 x	15 - 30 x	10 - 15 x	16 x	15 x
Länge in cm	30 cm	25 - 50 cm	25 - 50 cm	18 - 20 cm	30 - 50 cm

Platten

Granit 30x60x3cm	
hellgrau	dunkelgrau
•	•



Sandstein
30x60x3cm gelb-bunt
•



Sandstein
Polygonal grau-bunt
•



Quarzit
Polygonal gelb
•



Linienentwässerung

Breite: 12 cm

Höhe: 10 cm

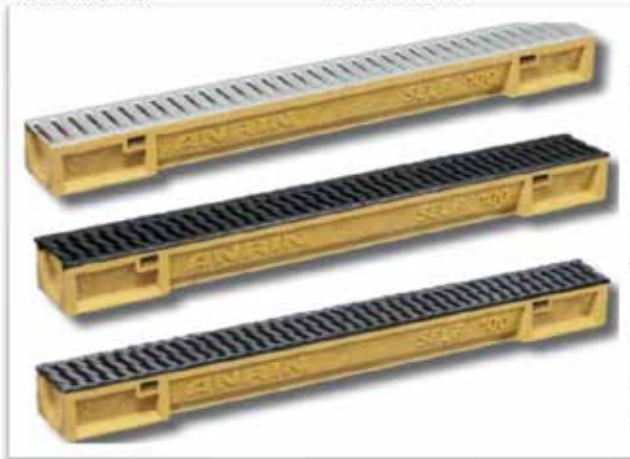

Anrin Self 100 Stegrost verzinkt Kl. A

100 cm
50 cm

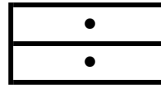

Anrin Self 100 Gussrost "Oval-Grip" Kl. B

100 cm
50 cm

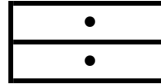

Anrin Self 100 Kunststoffrost "Oval-Grip" Kl. B

100 cm



Stirnwand
geschlossen



Breite: 13 cm

Höhe: 7 cm



Anrin Self-PP Kunststoffrinne
mit Kunststoffrost

100 cm



Stirnwand
mit Stützen DN 110

Stirnwand-Set



Breite Rinnen



Anrin Self 150

Anrin Self 200

100 cm lang

Breite: 20 cm Höhe: 15 cm

Breite: 25 cm Höhe: 15 cm

vz. Rost Kl. A

begehrbar

Maschenrost B

Maschenrost B

(Abbildung)

PKW-befahrbar!

Gußrost C

Gußrost C

Kantenschutzrinne

Anrin Drain KE-100

Mit oder ohne
Gefälle (0,5%) lieferbar!



VERZINKTE STAHLKANTE

z.B. Typ 010

SCH. LACK. STAHLKANTE

Maschenrost B

Breite: 13,6cm

KST-Rost C

MW 30/14 - Twistlock

Höhe: 20 cm

"Oval Grip" verschraubt



Anrin Drain SF-100

SCHWERLAST

SCH. LACK. STAHLKANTE

z.B. Typ 010

Gußrost F900

Breite: 16,4cm

Höhe: 21,5 cm

"RapidLock" Verschuß



Straßeneinläufe

BEGU Aufsatz Kl. D400

500 x 500 mm



300 x 500 mm



Schlammeimer

Höhe: 25 cm



Rinnenform
mit Einlage

Form B 1



Ausgleichsring

Höhe: 6 cm



Teil 10 a

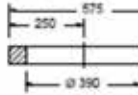

Schaft

Höhe: 19,5 cm



Teil 5 c

Schaft

Höhe: 29,5 cm



Teil 5 b

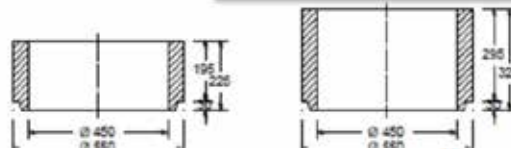

Zwischenteil

Höhe: 19,5 cm



Teil 6 b

Zwischenteil

Höhe: 29,5 cm



Teil 6 a

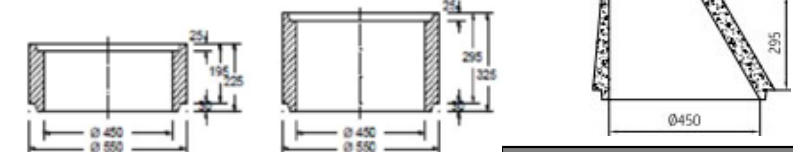

Bodenteil

mit PVC-Steckmuffe DN 150

Höhe: 33 cm



Teil 1 a

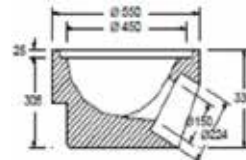

Schaftkonus

Teil 11

Höhe: 29,5 cm



Hofeinlauf / Abdeckungen

Anrin Self Hofeinlauf

Kl. B 125 (Gußrost)

25 x 25 x 30 cm

inkl. Eimer u. Siphon

PVC-Anschluß DN 110



waagerecht



Upmann Kellerablauf
Edelstahlrost 15x15cm
mit drehbarem Aufsatzrahmen
herausnehmbarer Geruchverschluss



senkrecht



Guß-Aufsatz Kl. A

30 x 30 x 6 cm



Guß-Aufsatz Kl. B

30 x 30 x 9 cm



Guß-Aufsatz Kl. A

$\varnothing = 30 \text{ cm}$

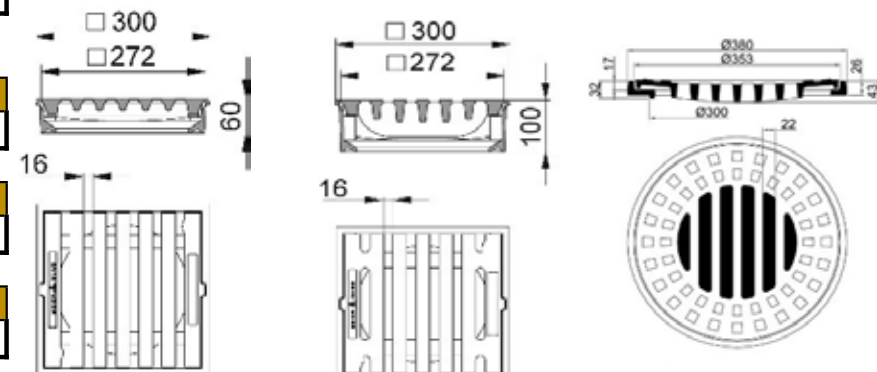

Schmiede-Geschränk, asphaltiert (schwarz) "Riffelblechabdeckung"

41 x 41 cm



begehbar,
"Klasse A"

51 x 51 cm



61 x 61 cm



Reparaturasphalt 25kg Topolit Bitumenfix, 0-5 mm



Schachtabdeckungen

Hatiba A 15
Enviro Top
Abdeckungen
aus Compton-
Verbundstoff



Niedersachsenroß

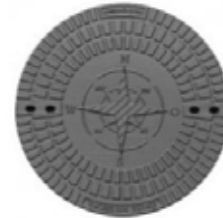

Windrose

BEGU A 15
Abdeckung aus Beton/Guss

B 125

PKW-befahrbar !

D 400

Schwerlast !

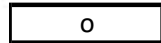

Schmutzfang

Stahl verzinkt



Kettengehänge leihweise möglich !

Schachtmaterial

Ausgleichsring
ca. 83 x 62,5 cm
(Da / Di)

- D = 4 cm
- D = 6 cm
- D = 8 cm
- D = 10 cm
- D = 12 cm

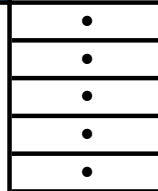

nach DIN 4034
Teil 2

Schachtkonus
Falzverbindung
9cm Wandstärke
Steigeisen

- 100 x 62,5 x 30 cm
- 100 x 62,5 x 60 cm



- 80 x 62,5 x 30 cm
- 80 x 62,5 x 60 cm

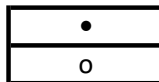

Schachtring 100 x 25 cm mit Steigeisen
Falzverbindung 100 x 50 cm mit Steigeisen
9cm Wandstärke 100 x 50 cm **Sickerring**



Brunnenring
Falzverbindung
9cm Wandstärke

- 80 x 25 cm
- 80 x 50 cm

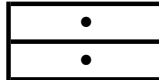

Schachtunterteile

mit Betonberme und Gerinne

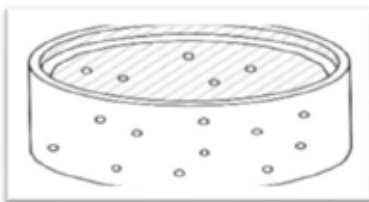

Sickerring ohne Steigeisen



Typ 1



Typ 10



Sumpf

80 x 50cm

Schachtunterteil mit Boden



100 x 50 cm

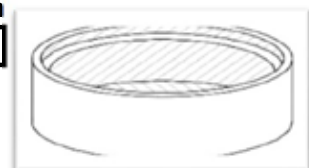
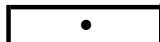

Bindemittel

Zement

CEM II/A-LL 32,5

25 kg

Zur Herstellung von Beton und Mörteln unter Zugabe von Wasser und Zuschlagstoffen (Sand oder Mischkies). Mit einer Produktion von 2,8 Milliarden Tonnen ist Zement der meistverwendete Werkstoff weltweit



Trasszement

CEM IV/B (P) 32,5N

25 kg

Ist eine übliche Bezeichnung für einen Zement, der durch die Beimischung von Trass einen wasser-dichteren Mörtel ergibt. Bei Verwendung mit Natursteinen zeigt er weniger Ausblühungen als bei der Verwendung von Portlandzement.



PM-Binder

Putz- und Mauerbinder

25 kg

zum herstellen von:
Mauermörtel für außen und innen
Putzmörtel für außen und innen



Trasskalk

HL 5 Hydraulischer Kalk

25 kg

Zur Herstellung von geschmeidigen, gut verarbeitbaren und widerstandsfähigen Baustellenmörteln, z.B. Vormauerwerk und Verlegemörtel. Insbesondere für die Verlegung von empfindlichen Natursteinbelägen und keramischen Bodenbelägen bzw. Platten, da die Gefahr der Kalkausblühungen gemindert wird



Baukalk

Weißkalkhydrat CL 90

25 kg

Dient zur Herstellung von Kalkmörtel, der als Mauer- und Putzmörtel eingesetzt wird. Im Bereich der Baugrundverbesserung kann Baukalk zur Bodenverfestigung verwendet werden. Verdünnt mit Wasser als Kalkschlämme zum weißeln oder kalkan von Wänden.



Schnellbinder

Tonerdeschmelzzement

25kg

Schnell aushärtender Zuschlag für Beton- und Mörtelprodukte. Mit Portland-Zement ergibt sich eine Erhärtung nach 3 bis 30 Minuten, je nach Dosierung



Zementfarbe

ohne Abb.

Pulverfarbe

1000 ml

Pigmente zum einfärben von Beton- und Mörtelprodukten

schwarz

rot

dunkelbraun

sand

Strahlmittel

Strahlmittel

quick-mix

STM

40 kg

0,10 - 0,80 mm

Gebrochener, künstlicher Mineralstoff, feuergetrocknet, scharfkantig und hart.



0,25 - 1,40 mm



1,0 - 2,0 mm

Zum Strahlen und Behandeln von Oberflächen aller Art. Zum Abtragen mürber Teile durch Strahlen. Zur Betonsanierung, Restauration, für Maler- und Lackierarbeiten

Mauern & Putzen

Mauer- u. Putzmörtel

K 01	40 kg	<input checked="" type="checkbox"/>
Estrich-Beton		
B 03	40kg	<input checked="" type="checkbox"/>
Zementmörtel		
Z 01	40kg	<input checked="" type="checkbox"/>

VOR-Mauermörtel

	40 kg	
VK 01	stark saugend	<input type="checkbox"/>
VM 01	schwach saugend	<input checked="" type="checkbox"/>
VZ 01	nicht saugend	<input type="checkbox"/>



Fugenmörtel

		40 kg	
Z 20	zementgrau	<input checked="" type="checkbox"/>	
HW 23	extraweiß	<input type="checkbox"/>	
QWW 113	beigeweiß	<input type="checkbox"/>	
OWZ 20	grauweiß	<input type="checkbox"/>	
OY 296.3	sandhell	<input type="checkbox"/>	
OS 27	silbergrau	<input type="checkbox"/>	
OS 28.1	dunkelgrau	<input type="checkbox"/>	
OS 29	anthrazit	<input type="checkbox"/>	
OS 30	schwarz	<input type="checkbox"/>	

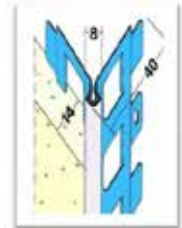

Hagalith Haftputz FF



40 kg

 Für Feuchtraum + Fassade
 Innen + Außen
Kalk-Zement Handputz



Renovier-Schnellputz

RSP 25kg

 Schnell erhärtender Kalk-Zement Handputz zum
 ausbessern und angleichen von Wandflächen.
 In Schichtdicken von 0 - 40 mm.
 Auch in Feuchträumen.
 Nach 12 Stunden mit Fliesen belegbar !

Außenputz-Eckschiene

Stahl verzinkt, mit PVC-Überzug
2,50 m

Repaflow USM Quellmörtel



25 kg

 zum Unterstopfen
 von Beton, Stahl und
 Holzkonstruktionen.
 Standfester Verfüllmörtel.



Rimat Rot 100

25 kg

 Leichter und ergiebiger Gips-Handputz
 für die manuelle Verarbeitung
 auch auf schwierigem Untergrund



Rippenstreckmetall

flachripp

260 x 60 cm



Putzgewebe



Rolle 100m²
 Anschnitt

Innenputz



Außenputz

Rolle 100m²

Anschnitt

Eckschutzschienen

Stahl verzinkt
2,00 m

2,60 m

Lehm Unterputz



25 kg

 mit Stroh

Lehm Oberputz



25 kg

 Fein 06

Ziegeldraht

1,0 x 5,0

0,30 x 5,0 m



Leichtbauplatten



zementgeb. Holzwolle
200 x 60 cm x

15 mm

25 mm

35 mm

50 mm



Schnellputzschienen

Stahl verzinkt, 10mm Putzdicke
2,50 m

 Stahl verzinkt, 6 mm Putzdicke
2,50 m

Transportbeton



Was wir für Ihre Bestellung benötigen:

1. Menge, Sorte und Konsistenz (Beispiele s. Tabelle)
2. Datum und Uhrzeit
3. Telefonnummer (Bauleiter) für Rückfragen und Termin

Mit Fahrmischern gelangt der fertige Transportbeton pünktlich und bequem auf Ihre Baustelle.

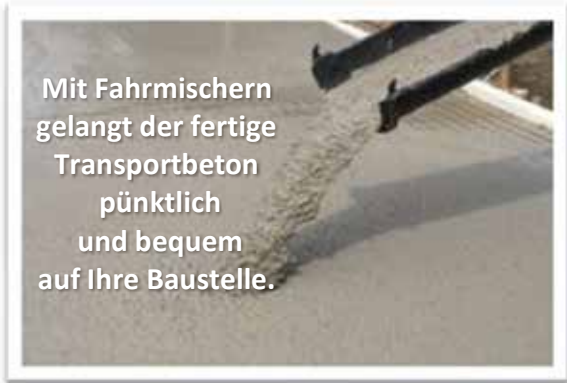

Beispiele gängiger Sorten:

	Sortenschlüssel	Konsistenz		
Beton C12/15 X0 F1 16 M	12012201	erdfeucht		
Beton C20/25 X0 F1 16 M	14012201	erdfeucht		
Beton C16/20 XC2 F3 16 M	13132201	"flüssig"		
Beton C16/20 XC2 F3 32 M	13133201	"flüssig"		
Beton C20/25 XC2 F3 16 M	14132201	"flüssig"		
Beton C20/25 XC2 F3 32 M	14133201	"flüssig"		
Beton C25/30 XC4, XF1 F3 16 M	15332202	"flüssig"	WU-Beton	(Wasserundurchlässig)
Beton C25/30 XC4, XF1 F3 32 M	15333202	"flüssig"	WU-Beton	(Wasserundurchlässig)

Sonderleistungen

Mögliche Zusatzmittel:

Fließmittel - erforderlich bei Rohrverlängerung (5 mtr)
Verzögerer bis 3 Stunden oder über 3 Stunden

Sonderleistungen:

Minderungen (Lieferungen unter 6 m³)
Stahlfasern (zuzüglich Fließmittel)
Restbeton (zuviel bestellt) - Entsorgungskosten
Wartezeiten (Entladezeit über 5 min/m³)

Nicht immer erlauben die örtlichen Gegebenheiten den Transportbeton an die unmittelbare Einbaustelle, mit dem Betonfahrmischer zu fahren. Dann sind Betonpumpen die idealen Fördergeräte. Mit Ihren langen Auslegern erreichen sie auch schwierige Einbauorte punktgenau.

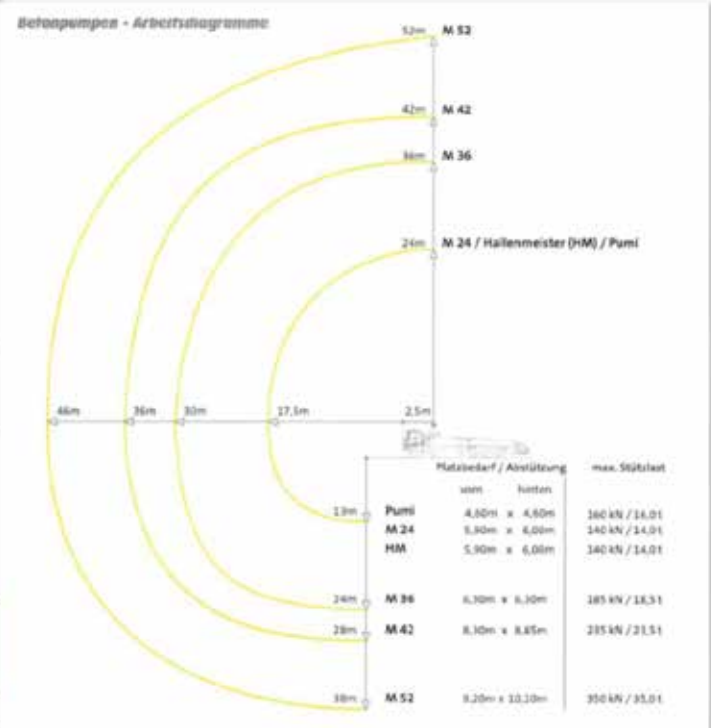

Folgende Betonpumpen stehen zur Verfügung:

- 24 m Mast - Hallenmeisterpumpe
- 36 m Mast - Pumpe
- 42 m Mast - Pumpe
- 52 m Mast - Pumpe

Der Nutzungspreis errechnet sich aus An- und Abfahrt, zuzüglich der Fördereistung je gepumpten m³ Beton.

Aufpreispflichtige Sonderleistungen und Zuschläge

Vergebliche An- und Abfahrt (Absage)

Keine Auswaschmöglichkeit auf der Baustelle !!

Rohr- und Schlauchleitungen

Vorlaufmischung (bei Stahlfaserbeton)

Baustahl

Rundstahl (Betonstahl) BST 500 S

Ø in mm	3,50	7,0 o. 14,0 m	Zuschnitt
8	•	o	o
10	•	o	o
12	•	o	o
14	o	o	o
16	o	o	o
20	o	o	o



Baustahlmatten BST 500 M



Typ	6,0 x 2,30 m	3,0 x 2,30 m	1,0 x 2,30 m	Drahtstärke
Q 188 A	o	•	•	Ø 6 mm
MW 15x15cm	6,0 x 2,30 m	MW 15x25cm	6,0 x 2,30 m	
Q 257 A	o	R 257 A	o	
Q 335 A	o	R 335 A	o	
Q 335 A	o	R 335 A	o	
Q 424 A	o	R 424 A	o	
Q 524 A	o	R 524 A	o	

Körbe aus Baustahlmatten BST 500 M



**Fix & Fertig konfektioniert,
nach Ihren Maßen erstellt.**

**Fertigungszeit von ca.
2-3 Tagen beachten !**



Zubehör

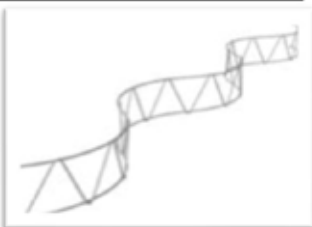

Erdungsband FVZ oder VA

30 m	o
60 m	o
Keilverbinder	o



Drahtmäuse

gegl. Draht 1,4mm

•

Betonbindedraht

mit 2 Schlaufen, 140mm

1000/VE

•



Dista "Schlange" 2,0 m

Stützbreite 20 cm

Höhe 8 cm	•
Höhe 10 cm	•

Drunterleiste 2,0 m

Höhe:

30/2	•
50/2	•

Dinki Abstandhalter

für Betonstahl bis Ø 12mm

250 St./Btl

•



Drillapparat

•

Formstahl

Stahlträger (schwarz)

Auf Wunsch auch Grundiert mit Rostschutzfarbe !

Angeschweißte Kopf- oder Fußplatten möglich !

Löcher bohren, für Durchsteckmontagen !



1-2 Tage Lieferzeit

Typ	Breitflanschträger			Formstahl-Träger	
	IPB / HEB	IPBI / HEA	IPBv / HEM	IPE	INP
		"leicht"	"verstärkt"	"mittelbreit"	"schmal"
100	100x100 mm 20,9 kg/m	100x96 mm 17,7 kg/m	106x120 mm 42,8 kg/m	55x100 mm 8,3 kg/m	50x100 mm 8,5 kg
120	120x120 mm 27,4 kg/m	120x114 mm 20,4 kg/m	126x140 mm 53,4 kg/m	64x120 mm 10,7 kg/m	58x120 mm 11,5 kg/m
140	140x140 mm 34,5 kg/m	140x133 mm 25,3 kg/m	146x160 mm 64,8 kg/m	73x140 mm 13,2 kg/m	66x140mm 14,7 kg/m
160	160x160 mm 43,7 kg/m	160x152mm 31,2 kg/m	166x180 mm 76,1 kg/m	82x160 mm 16,2 kg/m	74x160 mm 18,5 kg/m
180	180x180 mm 52,5 kg/m	180x171 mm 36,4 kg/m	186x200 mm 96,1 kg/m	91x180 mm 19,3 kg/m	82x180 mm 22,5 kg/m
200	200x200 mm 63,0 kg/m	200x190 mm 43,0 kg/m	206x220 mm 106,0 kg/m	100x200mm 23,0 kg/m	90x200 mm 27,0 kg/m
weitere auf Anfrage	Schnittkosten werden zusätzlich berechnet !				

Breite x Höhe !

Winkelstahl (verzinkt)

40 x 40 x 4 mm	50 x 50 x 5 mm	60 x 60 x 6 mm	80 x 40 x 6 mm	90 x 60 x 8 mm	100 x 50 x 8 mm	120 x 80 x 8 mm	150 x 100 x 10 mm
			80 x 80 x 8 mm		100 x 65 x 7 mm		
			1-2 Tage Lieferzeit		100 x 75 x 9 mm		
					100 x 100 x 10 mm		

Schalbretter

24 x 160 mm, 5,0 m lang

•

Bohlen

40 x 200 mm, 4,0 m lang

•



Universal-Schalclammer

•

Halfenschienen

HTA 28 / 15 HTA 38/17

o

o

Halfen-Anschlussanker

o



Poroton



Format	2 DF 0,9 / 12	
Größe	240 x 115 x 113 mm	
Gewicht	2,7 kg	
St. / m ²	32	<input type="checkbox"/>
St./Palette	384	

Format	3 DF 0,9 / 12	
Größe	240 x 115 x 113 mm	
Gewicht	3,8 kg	
St. / m ²	32 (17,5er) oder 45 (24er Wand)	<input type="checkbox"/>
St./Palette	256	

Format	Planziegel ZWP T - 11,5 cm	
Größe	498 x 175 x 248 mm	
Gewicht	11,2 kg	
St. / m ²	8	<input type="checkbox"/>
St./Palette	80	

Dünnbettmörtel

15 kg

Format	Planziegel T18 - 17,5 cm	
Größe	373 x 175 x 248 mm	
Gewicht	12,8 kg	
St. / m ²	11	<input type="checkbox"/>
St./Palette	75	

Format	Planziegel T18 - 24 cm	
Größe	373 x 240 x 248 mm	
Gewicht	17,5 kg	
St. / m ²	11	<input type="checkbox"/>
St./Palette	60	

Format	Planziegel T14 - 30 cm	
Größe	308 x 300 x 248 mm	
Gewicht	12,8 kg	
St. / m ²	13	<input type="checkbox"/>
St./Palette	60	

	U-Schalen	
	175 mm	<input type="checkbox"/>
	150 / Palette	
	240 mm	<input type="checkbox"/>
250 x 238 x	105 / Palette	
	300 mm	<input type="checkbox"/>
	90 / Palette	

			
Ziegelstürze			
	115 x 71 mm		175 x 71 mm
125 cm	<input type="checkbox"/>	125 cm	<input type="checkbox"/>
150 cm	<input type="checkbox"/>	150 cm	<input type="checkbox"/>
200 cm	<input type="checkbox"/>	200 cm	<input type="checkbox"/>
250 cm	<input type="checkbox"/>	250 cm	<input type="checkbox"/>

Schalungselemente

Ringbalkenschalung



Breite x Höhe x Länge	mit Korb Q188	ohne Bewehrung
11,5 x 25 x 120 cm	<input type="checkbox"/>	<input type="checkbox"/>
17,5 x 25 x 120 cm	<input type="checkbox"/>	<input type="checkbox"/>
24,0 x 25 x 120 cm	<input type="checkbox"/>	<input type="checkbox"/>

Deckenrandschalung

Silista Therm 035

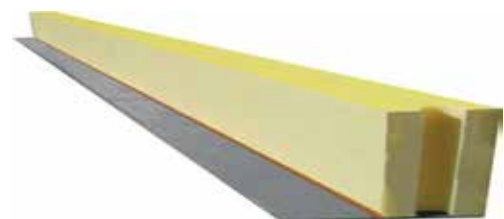



Höhe	Länge	Dämmstärke XPS	
180 mm	125 cm	40 mm	<input type="checkbox"/>
200 mm	125 cm	40 mm	<input type="checkbox"/>
180 mm	125 cm	60 mm	<input type="checkbox"/>
200 mm	125 cm	60 mm	<input type="checkbox"/>

Kalksandsteine



Format	DF 2,0 / 20	
Größe	240 x 115 x 52 mm	
Gewicht	2,7 kg	
St. / m ²	64 (flach) oder 32 (hochkant)	<input type="checkbox"/>
St./Palette	364	

Format	NF 1,8 / 12	
Größe	240 x 115 x 71 mm	
Gewicht	3,3 kg	
St. / m ²	48 (flach) oder 32 (hochkant)	<input type="checkbox"/>
St./Palette	288	

Format	2 DF 1,8 / 12	
Größe	240 x 115 x 113 mm	
Gewicht	5,3	
St. / m ²	32	<input type="checkbox"/>
St./Palette	216	

Format	3 DF 1,8 / 12	
Größe	240 x 175 x 113 mm	
Gewicht	8	
St. / m ²	32 (17,5er) oder 45 (24er Wand)	<input type="checkbox"/>
St./Palette	144	

Format	Planstein 4 DFL-R-P 1,4 / 12	
Größe	248 x 115 x 248 mm	
Gewicht	9,1	
St. / m ²	16	<input type="checkbox"/>
St./Palette	96	





**Dünnbett-
mörtel**
Lemga Duo

20 KG

Format	Planstein 8 DFL-R-P 1,4 / 12	
Größe	498 x 115 x 248 mm	
Gewicht	18,4	
St. / m ²	8	<input type="checkbox"/>
St./Palette	48	

Format	Planstein 6 DFL-R-P 1,4 / 12	
Größe	248 x 175 x 248 mm	
Gewicht	14	
St. / m ²	16	<input type="checkbox"/>
St./Palette	64	

Format	Planstein 12 DFL-R-P 1,4 / 12	
Größe	498 x 175 x 248 mm	
Gewicht	28	
St. / m ²	8	<input type="checkbox"/>
St./Palette	32	

Format	Planstein 8 DFL-R-P 1,4 / 12	
Größe	248 x 240 x 248 mm	
Gewicht	19,1	
St. / m ²	16	<input type="checkbox"/>
St./Palette	48	



**Planstein-
kelle**
11,5 cm

Format	Planstein 16 DFL-R 1,4 / 12	
Größe	498 x 240 x 248 mm	
Gewicht	38,2	
St. / m ²	8	<input type="checkbox"/>
St./Palette	24	

Format	Planstein 10 DFL-R-P 1,4 / 12	
Größe	248 x 300 x 248 mm	
Gewicht	23,9	
St. / m ²	16	<input type="checkbox"/>
St./Palette	32	

17,5 cm

24,0 cm

30,0 cm

36,5 cm















Format	Planstein 12 DFL-R 1,4 / 12	
Größe	248 x 365 x 248 mm	
Gewicht	26	
St. / m ²	16	<input type="checkbox"/>
St./Palette	24	

	U-Schalen	<input type="checkbox"/>
	115 mm	<input type="checkbox"/>
	96 / Palette	
	175 mm	<input type="checkbox"/>
	64 / Palette	
240 x 240 x	240 mm	<input type="checkbox"/>
	48 / Palette	
	300 mm	<input type="checkbox"/>
	32 / Palette	

	Stürze	<input type="checkbox"/>
	NF 115 x 71 mm	<input type="checkbox"/>
	100, 125, 150, 175, 200, 250, 300 cm	
	NF 175 x 71 mm	<input type="checkbox"/>
	2 DF 115 x 113 mm	<input type="checkbox"/>
3 DF 175 x 113 mm	<input type="checkbox"/>	

Porenbeton



<p>nach DIN 4166</p> <p>Planbauplatte 50 mm</p> <p>Größe 600 x 200 x 50 mm Gewicht 4,1 kg St. / m² 8,33 Palette 240 St. / 28,8 m²</p> 	 <p>Dünnbett- mörtel Lemga Duo 20 kg</p>	<p>nach DIN 4166</p> <p>Planbauplatte 70 mm</p> <p>Größe 600 x 200 x 70 mm Gewicht 5,9 kg St. / m² 8,33 Palette 168 St. / 20,16 m²</p> 
<p>nach DIN 4166</p> <p>Planbauplatte 100 mm</p> <p>Größe 499 x 100 x 249 mm Gewicht 8,5 kg St. / m² 8 Palette 120 St. / 15 m²</p> 		<p>PP4 / 0,5 * andere auf Anfrage</p> <p>Planstein 115 mm</p> <p>Größe 499 x 115 x 249 mm Gewicht 9,8 kg St. / m² 8 Palette 104 St. / 13 m²</p> 
<p>PP2 / 0,4 * andere auf Anfrage</p> <p>Planstein 150 mm</p> <p>Größe 499 x 150 x 249 mm Gewicht 11,25 kg St. / m² 8 Palette 80 St. / 10 m²</p> 	 <p>Porenbeton- Säge HM- bestückt</p>	<p>PP2 / 0,4 * andere auf Anfrage</p> <p>Planstein 175 mm</p> <p>Größe 499 x 175 x 249 mm Gewicht 13,1 kg St. / m² 8 Palette 64 St. / 8 m²</p> 
<p>PP2 / 0,4 * andere auf Anfrage</p> <p>Planstein 200 mm</p> <p>Größe 499 x 200 x 249 mm Gewicht 15 kg St. / m² 8 Palette 56 St. / 7 m²</p> 		<p>PP2 / 0,4 * andere auf Anfrage</p> <p>Planstein 240 mm</p> <p>Größe 499 x 240 x 249 mm Gewicht 18,1 kg St. / m² 8 Palette 48 St. / 6 m²</p> 
<p>PP2 / 0,4 * andere auf Anfrage</p> <p>Planstein 300 mm</p> <p>Größe 499 x 300 x 249 mm Gewicht 20 kg St. / m² 8 Palette 40 St. / 5 m²</p> 	 <p>Planstein- kelle 11,5 cm</p>	<p>PP2 / 0,4 * andere auf Anfrage</p> <p>Planstein 365 mm</p> <p>Größe 499 x 365 x 249 mm Gewicht 24,4 kg St. / m² 8 Palette 32 St. / 4 m²</p> 
<p>U-Schalen 175 mm</p> <p>96 / Palette</p> <p>200 mm</p> <p>64 / Palette</p> <p>240 mm</p> <p>48 / Palette</p> <p>300 mm</p> <p>32 / Palette</p> <p>365 mm</p> <p>32 / Palette</p> <p>500 x 250 x</p> 		<p>Stürze STN 100 x 249 x 1.250 mm 115 x 249 x 1.250 mm</p> <p>Stürze FST 115 x 124 x 1250 mm 115 x 124 x 1500 mm 115 x 124 x 2000 mm 115 x 124 x 2500 mm 115 x 125 x 3000 mm</p> <p>175 x 124 x 1250 mm 175 x 124 x 1500 mm 175 x 124 x 2000 mm 175 x 124 x 2500 mm 175 x 124 x 3000 mm</p> 

Maurerbedarf

PE Baufolie 0,20 mm



Breite in cm

200µ

Bitumenpappe	11,5	•
Mauersperrbahn	17,5	•
R500 besandet	25	•
	30	•
10 lfm./Rll	36,5	•
	50	o

Rll. 4 x 25 m	•
Anschnitt	•



Alujet Isolierfolie	11,5	•
"Walljet"	17,5	•
	24	•
	30	•
	36,5	•
	50	•
50 lfm./Rll.	75	•

Luftschichtanker

V4a Stahl

Ø x Länge in mm VPE 250 St.

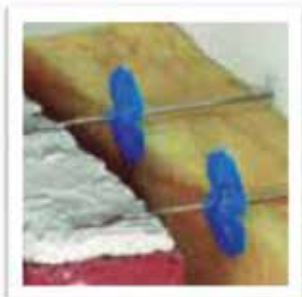

Universal-Dübelanker mit Holzschraubgewinde	4/235	Paket	Einzel
		•	•

Well-Dübelanker	3/210	•	•
Nylondübel		•	•
Klemmscheibe		•	
	4/300	•	•
	4/350	•	•

ausgestrichelt mit Welle

inkl. Dübel
inkl. Dübel



Well-Luftschichtanker	3/225	•	•
	4/275	•	•
	4/400	o	



Klemmscheibe

Multi-Luftschichtanker	4/320	•	•
	4/360	•	•



Nylondübel

Mauerverbinder MV 300 x 22 x 0,6mm	300	•	•
---	-----	---	---

Stoßfugenlüfter
hellgrau
12 x 60 x 115 mm
•



Lüftung-/Wetterschutzgitter
Edelstahl / Alu
oder Kunststoff
div. Formate
•



ATIKA®
Betonmischer



ATIKA® Rührwerke

Comet 130 mit Handrad

•

Profi 145

•

mit Handrad u. Fußbremse

RW 1400
•



RW 1800 Twin
•



Schornsteine

Schreyer Schornstein FUMDS



Feuchteunempfindlicher Mehrschalen Dämmschornstein



1- oder 2-Zülig
auch mit
ungleichen Ø

Bestehend aus hochwertigem Dämm-Leichtbetonmantel, feuer- und säurefestem Schamotte-Innenrohr und hochtemperaturbeständiger, feuchte-Mineralwolldämmmatte

Für Öl- und Gasfeuerstätten

Für feste Brennstoffe wie z.B. Holz und Kohle



Mantelstein mit Dämmschale und Innenrohr



Putztüranschluss



Reinigungstür mit Vorsatzschale



Rauchrohranschluss



Konsolezylinder



Säurekitt

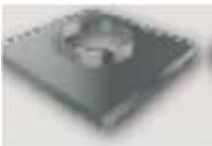

Abdeckplatte für Verschieferung



Dehnungsfugenmanschette

Sparrenhalter

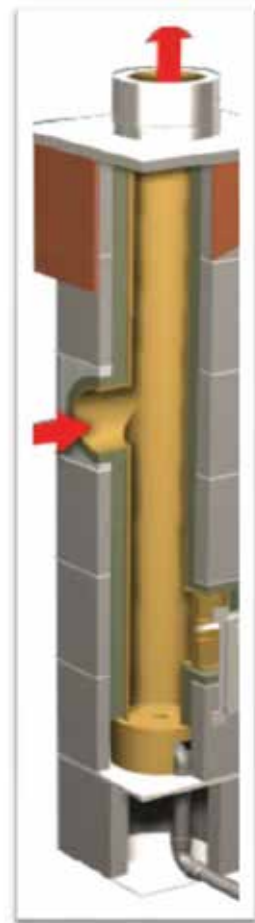

Schamottesteine



Schamottestein

250 x 124 x

40 mm 65 mm



Schamotteplatte

400 x 200 x

20 mm 30 mm



Lieferung mit Kranentladung direkt zur Baustelle

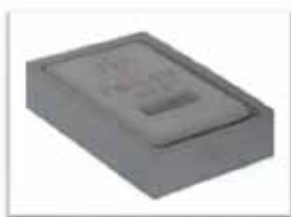

Beton Kaminschieber

PA IV 273

21 x 30 cm



Kamintür verzinkt

PA IV

14 x 21 cm



Feuerfestmörtel

2 kg



Bauwerksabdichtung



Multi-Baudicht 2K

Die All-in-One Abdichtung!
25 kg



Universal einsetzbar: Innen und Außen, im Neu- und Altbau, im Sockel- und Maueraufstandsbereich sowie unter Plattenbelägen



SANDRO PLAST
SANDROCK GMBH

Bitumen-Isolieranstrich

5 Liter	10 Liter
•	•
Silolack	10 Liter
	•



Bitumen-Dickbeschichtung

30 Liter	•	Bit-1K basic
10 Liter	•	

Verbrauch:

4,5 - 5,5 kg /m²



Bitumen-Dickbeschichtung

30 Liter	o	Bit-2K basic
----------	---	---------------------

schneller trocknend, für die "kalte" Jahreszeit



Dichtspachtel

25 kg	o
-------	---

Mit hohem Sulfatwiderstand
Zur Herstellung von Dichtungskehlen

Grundmauerschutz / Noppenbahnen



PM Geo Tec

Noppenbahn
+ Vlies
+ Gleitfolie

Rolle

15 X 2,50 M

•

*Noppenbahnen sind keine Abdichtungsbahnen!
Sie dienen dem Schutz einer normgerechten Abdichtung*

Noppenbahn

2 x 20 m

Rolle	•
Abschnitt	•



Bautenschutzmatte



Gummigranulatmatte

100 x 200 cm

•

 x 8 mm
KraiTec Top 1000

Bauchemie



(Haft-) Emulsion

1 kg	•
5 kg	•

Polymerdispersion,
Mörtelvergütung und
Haftemulsion
für
Mörtel, Putz, Beton



Dichtungsmittel

1 kg Pulver	•
5 kg flüssig	•

Hydrophobierendes
Dichtungsmittel
für Beton- und
Stahlbeton
Verbrauch: 3 - 4 kg / m³



Mischöl (LP)

5 kg	•
10 kg	o

Luftporenbildner-
und
Mörtelzusatzmittel



Schalöl

10 Ltr	•
--------	---

Universal Trennmittel
Ergiebig: 40-80 m²/10L
je nach Saugfähigkeit
der Schalung



Estrix / Estrifix

1 kg	•
5 kg	•

Synthetische Estrich-
vergütung -
Spezialverflüssiger,
Schnellere Belagsreife
Verbrauch: 1,5 kg / m³



Bauharz Apogel F

1 kg	•
------	---

Lösemittelfreies
Bauharz, 2-komponentig

Apogel schnell

0,5 kg	•
--------	---



Antifrost

1 kg	•
5 kg	o

Mörtelzusatz als Abbinde-
beschleuniger bei
Frost oder Frostgefahr
Verbrauch: 0,5-2 kg/50kg Zement



Kiesol

1 kg	•
5 kg	•
10 kg	•
30 kg	o

Lösemittelfreies,
verfestigendes Verkiese-
lungskonzentrat



Kiesol C

550 ml	•
5 kg	•

Lösemittelfreie Silancreme
für Horizontalsperren
gegen aufsteigende
Mauerwerksfeuchtigkeit



Bohrloch suspension

20 kg	•
-------	---

Fließfähiger,
mineralischer Füll-
und Injektionsmörtel

Bauchemie



Montageschaum

500 ml



Pistolenschaum

750 ml



PU-Reiniger

500 ml



2-K Zargenschaum

400 ml

Brunnenschaum

750 ml

Schaumpistolen

NBS Blue

NBS Silverstar



Acryl

310 ml

weiß

grau

braun

weiß Strukt.



<input type="checkbox"/>
<input type="checkbox"/>
<input type="checkbox"/>
<input type="checkbox"/>



HT-Silikon

Hochtemperatur bis 300°C

310 ml

dunkelrot



Silikon

310 ml

glasklar



Silikon - acetat-

310 ml

transparent

weiß

manhattan



Pro 4 Silikon Premium

310 ml

transparent

weiß

silbergrau

betongrau

zementgrau

anthrazit

schwarz

bahamabeige

hellbraun

mittelbraun

Glättmittel

500 ml



Keine Randzonenverfärbung.
Auch für Naturstein.
Geruchsneutral.
Haftet ohne Primer.
Für Innen + Außen

Compriband

KP-Band 100 Plus

4/10 mm

6/15 mm

12/20 mm



Hinterfüllmaterial (PE-Rundschnur)

5 m /Rll.

Ø 10 mm

Ø 15 mm

Ø 20 mm



Bauchemie

Klebstoffe



MK-Fest 310 ml
weiß

Montagekleber für Innen



PU-Kraftkleber 310 ml
beige

Universeller Steinkleber



Gecko Hybrid 310 ml
weiß
schwarz

Karosserie und unter Wasser



Alcon 10 310 ml
beige

Konstruktionsklebstoff



W-Stop 1 kg
grau

Reparaturdichtmasse



Bitu-Dicht 310 ml
schwarz
silbergrau

1-Komp.-Bitumendichtmasse



BT-Band 7,5 cm x 1,5 m
Alu-blank

Reparaturband



Sanierputz



Vorspritzmörtel

30 kg



Sanierputz - Altweiß

20 kg



Schimmelsanierung



Schimmel-Stop mit Chlor

1000 ml

Sporenbinder

5 Liter



Schimmel-Sanierputz

20 kg

Schimmel-Sanierfarbe

5 Liter

15 Liter



Schimmel - Sanierplatte (Kalciunsilikat)

	25 mm	<input type="checkbox"/>
1000 x 500 x	30 mm	<input type="checkbox"/>
	50 mm	<input type="checkbox"/>
500 x 250 x	15 mm	<input type="checkbox"/>

Verblendmauerwerk

iking
Klinkerwerk



Wienerberger
Building Material Solutions



Kerndämmplatten, vlieskaschiert
KDP 2/V WLG 035

625 x 1.250 mm

Dicke	Paket	
40 mm	9,38 m ²	•
50 mm	7,81 m ²	o
60 mm	6,25 m ²	o
80 mm	4,69 m ²	o
100 mm	3,91 m ²	o

Besuchen Sie unsere Ausstellung !

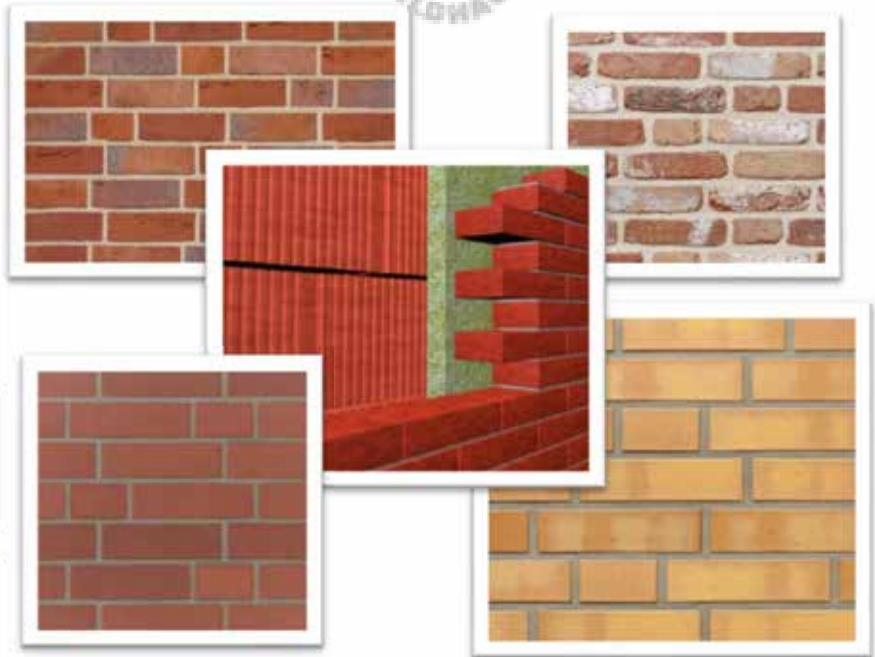

WDVS Fassaden

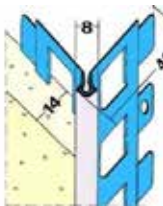

Außenputz-Eckienen
2,50 m

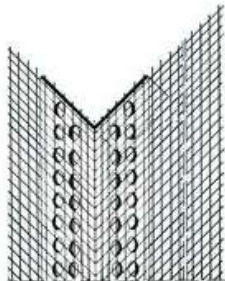

Gewebe-Eckwinkel
2,50 m



Anputzleisten mit Gewebe
2,60 m

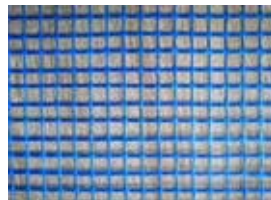
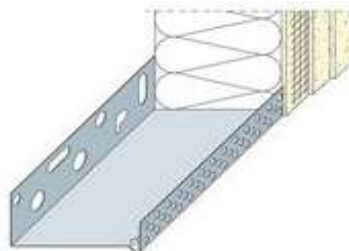

Außenputz-Gewebe



quick-mix



Spachtel- und Klebemörtel SKS
25 kg



Edelfeinputz 0-1 mm
30 kg



Scheibenputz 0-2 mm
30 kg



Münchner Rauputz
30 kg

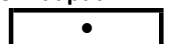

Fensterbänke

Längen: bis zu 2500 mm garantiert

Bei Zwischenbreiten werden die nächstgrößere Standardbreite + Zuschnittkosten berechnet.

Stärke: 20 mm (Standard)

30 mm auf Anfrage

Rechtwinklig zugeschnitten, Länge nach Maßangabe
Bei polierter (Standard-) Oberfläche mit polierter Vorderkante.

Köpfe ca. 80 mm von vorn bearbeitet.

Wassernasen bei Außenfensterbänken möglich.

Gestockte Ausführung (raue Oberfläche) auf Anfrage möglich !

Breiten	150 mm	200 mm	250 mm	300 mm
	350 mm	400 mm	450 mm	500 mm

GRANIT



Serizzo



Rosa-Beta



Cristallo



Golden Hill

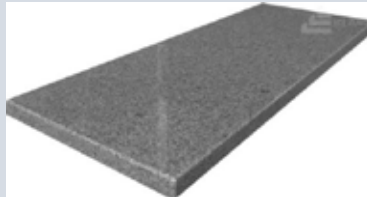

Dark Valley



Red Vulcano



Nero Impala



Multicolor Red



Absolut Nero

Marmor



Jura gelb



Bianco-Carrara



Agglo Perlato-Appia

Micromarmor (Kunststein)

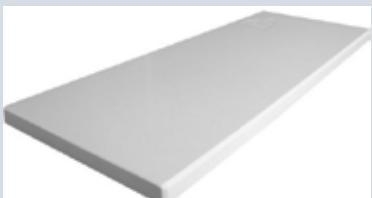

Arktis



Silver-Gray



Bianco



Montana



Sahara



Polar

Alu - Fensterbänke

Längen: bis 6.000 mm in einem Stück
 Einbau bis max. 3000 mm Länge,
 größere Längen mehrteilig.

Breite:

50 mm

70 mm

90 mm

110 mm

130 mm

150 mm

165 mm

180 mm

195 mm

210 mm

225 mm

240 mm

260 mm

280 mm

300 mm

320 mm

360 mm

380 mm

400 mm



Außenfensterbänke

Fixlängen rechtwinkling zugeschnitten,
 40 mm Abkantung vorne,
 25 mm Aufkantung an der Rückseite.

Oberfläche mit Schutzfolie abgeklebt.

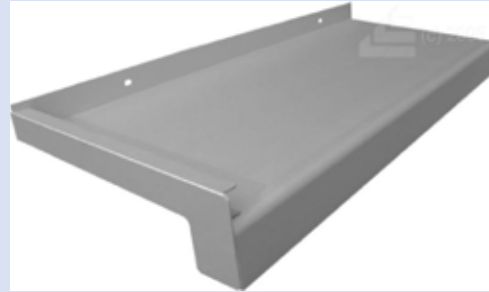

Aluminium - Abschlußstücke

50 - 120 mm

150 - 180 mm

195 - 360 mm

380 - 400 mm

Fliesenlegerbedarf



Jackoboard Plano

Allround Bauplatte für den Innenausbau



Direkt verfliesbar, verspachtelbar oder verputzbar

Dicke	Breite	Länge	
4 mm	x 600 x	1300	•
6 mm		1300	•
10 mm		1300	•
10 mm		2600	o
20 mm		2600	•
30 mm		2600	•
40 mm		2600	o
50 mm		2600	•

Jackoboard Canto

Winkelement

Speziell für Eckausbildungen und Rohrverkleidungen

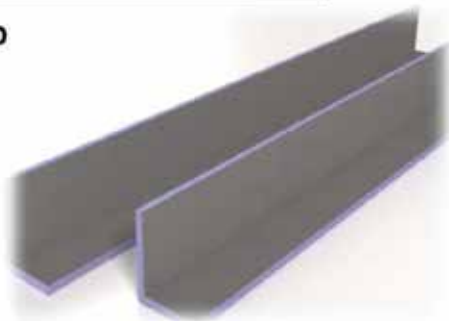

Schenkel	Länge	
150 x 150 mm	2600	•
200 x 200 mm	2600	•
300 x 300 mm	2600	•
200 x 400 mm	2600	o

Grundieren



Gisogrund

Haft- u. Schutzgrundierung für saugende Untergründe

1 Ltr.	•
5 Ltr.	•



Gisogrund Rapid

Blitzgrundierung auf zementären und gipshaltigen Untergründen

1 Ltr.	•
5 Ltr.	•



Gisogrund 303

Spezial-Haftgrundierung auf glatten, nicht saugenden Untergründen

1 Ltr.	•
5 Ltr.	•



Emulsion

Mörtel-Haftzusatz Für Neu- auf Altbeton. Als Zusatz zur Vergütung.

1 Ltr.	•
5 Ltr.	•



Gisogrund 404

Spezial-Haftgrundierung auf saugenden und nicht-saugenden Untergründen

5 Ltr.	•
--------	---



Gisopak

Gipsputz-Haftbrücke auf glatten Untergründen

5 Ltr.	•
--------	---

Fliesenlegerbedarf

Abdichten



Seccoral
Flexible Dichtschlämme unter Keramikbelägen
Auf Balkonen, Terrassen, in Duschanlagen

3,5 kg	<input type="checkbox"/>
15 kg	<input type="checkbox"/>



Lastogum
Wasserdichte, flexible Schutzschicht

4 kg	<input type="checkbox"/>
8 kg	<input type="checkbox"/>



Pecilastic E
Entkopplungsbahn 3 mm
1 x 5 m

5 m ²	<input type="checkbox"/>
------------------	--------------------------



Pecitape
Dichtband 120mm

lfm	<input type="checkbox"/>
-----	--------------------------



Dichtmanschette

10 x 10 cm	<input type="checkbox"/>
------------	--------------------------



Außenecke



Innenecke

Dichtecken

Kleben + Fugen



S 1 Flott
Flexkl. Großformate

20 kg	<input type="checkbox"/>
-------	--------------------------



FT Extra
Flexkleber

25 kg	<input type="checkbox"/>
-------	--------------------------



Carrament weiß
Naturstein-Ansetzmörtel

25 kg	<input type="checkbox"/>
-------	--------------------------

Nanolight
Flexkleber

15 kg	<input type="checkbox"/>
-------	--------------------------



PCI
Für Bau-Profis



FT Rapid
Schnell-Fliesenkleber

25 kg	<input type="checkbox"/>
-------	--------------------------



Nanofug Premium
Variabler Flexfugenmörtel

5 kg	<input type="checkbox"/>	silbergrau
		anthrazit
		jurabeige
		weiß
		sandgrau
		zementgrau

weitere Farben lieferbar !

Betonsanierung

Repafix

Reparatur- und Modelliermörtel

5 kg

Für Boden, Treppen und Wände aus Beton.
Schichtdicken 2-50 mm.



Nanocret FC

Faserverstärkter Betonspachtel

5 kg

Für Wand und Decke.
Schichtdicken 1-10 mm.
45min. Verarbeitungszeit



Polyfix 5 Min.

Blitz-Zement-Mörtel

1 kg

5 kg

15 kg

Zum Verankern von Maschinen, Türzargen, Geländern und Treppen.



Nanocret R4 PCC

Beton-Instandsetzungsmörtel

25 kg

Hochfester Mörtel für Betonbauteile.
Boden, Wand und Decke.
Schichtdicken 5-50 mm

OSP 31

Spachteln- und Nivellieren

25 kg

Zum Ausgleichen von zementären Untergründen, Gussasphaltestrichen, Calciumsulfatestrich.
Schichtdicken 0,5 - 15 mm
Leicht verlaufend.



Zemtec 180

Fließestrich

25 kg

Für Verbundestriche und Estriche auf Trenn- oder Dämmschicht.
Nach 3 Stunden begehbar, nach 1 Tag belegbar.
Schichtdicken 15 - 80mm



Novoment M1/3 plus

Schnellestrich-Fertigmörtel

25 kg

Für schnell härtende Zementestriche.
Nach 3 Stunden begehbar, nach 1 Tag belegbar.
Schichtdicken 20 - 80 mm

M3: Nach 1 Tag begehbar, nach 3 Tagen belegbar.

Novoment Z1/3

Estrich-Schnellzement

25 kg/ 20kg

Für schnell belegereife Estriche.
Nach 3 Stunden begehbar, nach 1 Tag belegbar.
Schichtdicken 35 - 100 mm
Mischungsverhältnis 1:5

Z3: Nach 1 Tag begehbar, nach 3 Tagen belegbar.



Hartschaum Dämmung

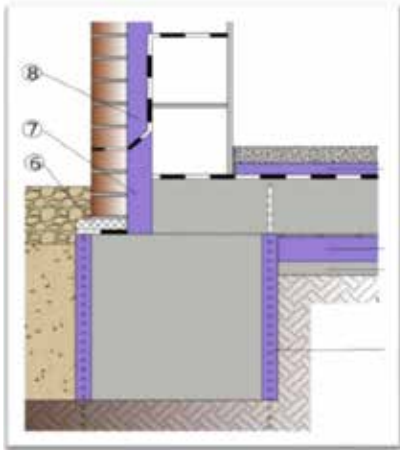

Extrudiertes Polystyrol XPS

Jackdur KF 300
1250 x 600 mm

Dicke:

20 mm	•
30 mm	•
40 mm	•
50 mm	•
60 mm	•
80 mm	•
100 mm	•
120 mm	○
140 mm	○



PUR Dämmplatte Alukaschiert beidseitig

1200 x 600 mm

Dicke:

20 mm	○
30 mm	○
40 mm	○
50 mm	○
60 mm	○



Mauerrandstreifen XPS	L = 1.250 mm Querschnitt:	80	80	80	80	100
		x 100	x 120	x 140 mm	x 180 mm	x 120 mm
		○	○	○	○	○



Randdämmstreifen

PE-Schaum

Höhe/Dicke

80 / 5	•
120 / 5	•
150 / 5	•
250 / 10	•
100 / 10	○
120 / 10	○
150 / 10	○



Styropor

EPS 040 DI/WI

1000 x 500 mm	
10 mm	•

EPS 035 DEO/WAB

20 mm	○
30 mm	○
40 mm	○
50 mm	○

Trittschalldämmbahn

1 x 12,5 m	•
5 mm	



Innendämmung



Spannfilz KF2 035

climowool
einfach. clever. dämmen.

Rolle =

Dicke:	1200 x		Rolle =
100 mm	5.600 mm	6,72 m ²	•
120 mm	4.800 mm	5,76 m ²	•
140 mm	4.000 mm	4,80 m ²	•
160 mm	3.500 mm	4,20 m ²	•
180 mm	3.200 mm	3,84 m ²	•
200 mm	2.800 mm	3,36 m ²	•
220 mm	3.300 mm	3,96 m ²	o
240 mm	3.000 mm	3,60 m ²	o
260 mm	3.000 mm	3,60 m ²	o
280 mm	2.800 mm	3,36 m ²	o
300 mm	2.800 mm	3,36 m ²	o

Spannfilz KF3 032

climowool
einfach. clever. dämmen.
Rolle =

Untersparrenfilz UF3/V 032

einseitig mit
Glasvlies
kaschiert

Dicke:	1200 x		Rolle =	30 mm		1.250 x 12.000 mm	
100 mm	4.000 mm	4,80 m ²	o			o	
120 mm	3.200 mm	4,20 m ²	o			15,00 m ²	
140 mm	2.800 mm	3,60 m ²	o				
160 mm	2.500 mm	3,00 m ²	o	40 mm		1.250 x 8.000 mm	
180 mm	2.200 mm	2,64 m ²	o			10,00 m ²	
200 mm	3.000 mm	2,40 m ²	o				
220 mm	2.500 mm	2,16 m ²	o	60 mm		1.250 x 6.000 mm	
240 mm	2.300 mm	2,16 m ²	o			7,5 m ²	



Klemmrock 035

Dicke:	1.000 x		Rolle =
120 mm	4.000 mm	4,00 m ²	o
140 mm	3.500 mm	3,50 m ²	o
160 mm	3.000 mm	3,00 m ²	o
180 mm	2.500 mm	2,50 m ²	o
200 mm	2.500 mm	2,50 m ²	o
220 mm	2.000 mm	2,00 m ²	o
240 mm	2.000 mm	2,00 m ²	o

Proclima System

Feuchtevariable Dampfbrems- und Luftdichtungsbahn	Rolle
Intello Plus	•
1,50 x 20 m	30 m ²
1,50 x 50 m	75 m ²
	o

UniTape

Überlappungsklebeband

60 MM x 30 M

Tescon Vana

Allround-Klebeband

60 MM x 30 M

Orcon F

Hochleistungs-Kleber

310 ML

Systemprodukte



Holzfaser-Dämmplatten



Steico Protakt

Putzbeschichtbare Holzfaser-Dämmplatte

1.325 x 600 mm

40 mm

1 Stück

60 mm

1 Stück

1.350 x 600 mm

20 mm

1 Stück

Laibungsplatte



Steicoflex

flexible, klemmfähige

40 mm

m²/Pak.

7,02

Wärmedämmung

60 mm

5,61

1220 x 575 mm

80 mm

4,21

100 mm

2,81

120 mm

2,81

140 mm

2,81

160 mm

2,11

200 mm

2,11



<input type="checkbox"/>
<input type="checkbox"/>
<input type="checkbox"/>
<input type="checkbox"/>
<input type="checkbox"/>
<input type="checkbox"/>
<input type="checkbox"/>
<input type="checkbox"/>

Steico - Universal

Diffusionsoffene Unterdeck- und

Wandbauplatte

22 mm

1 Stück

2.500 x 600 mm

35 mm

1 Stück

52 mm

1 Stück

Steico - Universal Dry

Unterdeck- und Wandbauplatte

2.500 x 600 mm

35 mm

1 Stück

1.880 x 600 mm

60 mm

1 Stück

80 mm

1 Stück

100 mm

1 Stück

Minerale Dämmplatten

Innendämmung von Außenwänden.

Kellerdeckendämmung.

Wärmedämm-Verbundsystem



580 x 380 mm

Dicke

VPE

50 mm

12 Stück

60 mm

10 Stück

80 mm

7 Stück

100 mm

6 Stück

120 mm

5 Stück

140 mm

4 Stück

Putzgewebe TG11

m²

100 m² / Rolle

oder Anschnitt

Spachtel- und Klebemörtel
MS-KS-L
20 kg



Fußboden



Rigidur

Gipsfaser-Estrichelemente

20 mm	•
30 mm	•
40 mm	o
50 mm	o

mit 10 mm Mineralfaser
mit 20 mm Styropor
mit 30 mm Styropor

1.500 x 500 mm

Gipsfaser-
platten-
Schrauben
3,9 x 19 mm
200 / Pak.
•
1000 / Pak.
•



Rigidur Estrichkleber

Nature Line

1000 ml.

•

Aquapanel

Cement-Board Floor
Trockenestrich aus Portlandzement
100% Wasserbeständig

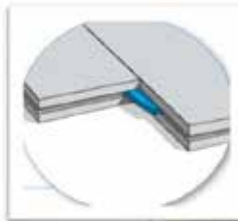

600 x 900 mm	22 mm	o
	33 mm mit 10 mm Mineralfaser	o

Aquapanel Nutkleber

310 ml.

o

Aquapanel Flachdübel

100 St.

o

Trockenschüttung

Ausgleichsschüttung unter
Trocken- und Naßestrichen Fibotherm 1-5 mm

50 Liter

•



Pornit FB

Dachboden-
Dämmelemente
zur Dämmung der
obersten Geschoßdecke
in unbeheizten Räumen.

V100 Spanverlegeplatte 19mm
EPS (Styropor) DEO 100 kPa

Rohfilzpappe/Rieselschutz:	1.250 x 1.010 mm					
1 x 50 m	o	Gesamtdicke:	99 mm	119 mm	139 mm	159 mm
auf alten Dielenbelägen	o	WLG 035	o	o	o	o
	o	WLG 032	o	o	o	o



OSB 3 - Profi Line

Verlegeplatten für Wand und Boden

OSB 3 / EN 300
Contifinish
ungeschliffen

2500 x 675 mm

12 mm	15 mm	18 mm	22 mm	25 mm
•	•	•	•	o

Profiltechnik

Wände



CW-Profil
0,6/50
2.600 mm
2.750 mm
3.000 mm
3.500 mm
4.000 mm
4.500 mm
5.000 mm

Pofilverbundzange
•



Ständerprofile			
	50 mm	75 mm	100 mm
2.600 mm	•	•	•
2.750 mm	o	o	o
3.000 mm	•	•	•
3.500 mm	o	o	o
4.000 mm	o	o	o
4.500 mm		o	o
5.000 mm		o	o

Boden/Deckenprofile			
UW Profil	50 mm	75 mm	100 mm
0,6/40 mm			
4.000 mm	•	•	•

UA Profil	Leitungsprofil für Türen		
2,0/40mm	50 mm	75 mm	100 mm
3.000 mm	•	•	•



Trennwandband			
3 mm, selbstklebend, 30 lfm./Rolle			
50 mm	75 mm	100 mm	
•	•	•	



Anschlagwinkel für UA-Profil
75 + 100 mm
•



Wärmedämmung

Trennwandplatte Climowool TWP 040		
	40 mm	o
	50 mm	o
	60 mm	o
	80 mm	o
	100 mm	o
1.250 x 625 mm		



Rockwool	Trennwand	Brandschutz
625 x 1000 mm	Sonorock	Terमारock 40
40 mm	•	o
50 mm	o	o
60 mm	•	o
80 mm	•	o
100 mm	o	

Decken

CD Profil	Direktabhänger f. CD-Profil	
0,6 mm	60 / 27 mm	60/27 mm
4.000 mm	•	•

Sicherheits-Verbinder
60/27 mm
•

Ankerfix Schnellabhänger
60/27 mm
•

UD Profil	Längsverbinder f. CD-Profil	
0,6 mm	28 / 27 mm	60/27 mm
3.000 mm	•	•

Kreuzverbinder
f. CD-Profil
60/27 mm
•

Draht mit Öse für Ankerfix	
125 mm	•
250 mm	•
375 mm	•
500 mm	•
750 mm	•
1000 mm	o
1500 mm	o

Deckennagel	
6/35 mm	6/65 mm
•	•

Ständerwerkzargen



Profilbreite: CW/UA	Maulweite in mm	lichte Breite	lichte Höhe	
75 mm	100	750	2000 mm	<input type="radio"/>
		875		<input type="radio"/>
		1000		<input type="radio"/>
100 mm 1-lagig oder 75 mm 2-lagig	125	750		<input type="radio"/>
		875		<input type="radio"/>
		1000		<input type="radio"/>
100 mm 2-lagig beplankt !	150	750	<input type="radio"/>	
		875	<input type="radio"/>	
		1000	<input type="radio"/>	

1- bzw. 2-lagig = Beplankung mit 12,5er Gipskarton (!)

Revisionstüren



Stahlblech, Softline weiß mit Vierkantverschluß				Alu-Star mit GKI	
Maße in mm					
150 x 150	•		300 x 300	•	•
150 x 200	•		300 x 400	o	
			300 x 500	o	
200 x 200	•		300 x 600	o	
200 x 250	•				
200 x 300	•		400 x 400	•	
200 x 400	•		400 x 600	•	
200 x 500	o		500 x 500	•	
200 x 600	o				
250 x 250	o		800 x 1000	o	
			1000 x 1000	o	

Vierkantschlüssel 

Fugen - Spachtelmassen



Knauf
Uniflott
5 kg



Knauf
Uniflott imprägniert
5 kg



Rigips
Vario
5 kg



Rigips
Promix
18 kg



Pufamur
SH45
25 kg

<input type="radio"/>	<input type="radio"/>	<input type="radio"/>	<input type="radio"/>	<input type="radio"/>	<input type="radio"/>
-----------------------	-----------------------	-----------------------	-----------------------	-----------------------	-----------------------

Gipskarton

Bauplatten Typ A



Bauplatte Typ A		
9,5 mm		
1.250 x	2.000 mm	o
1.250 x	2.500 mm	o
600 x	2.000 mm	o
600 x	2.600 mm	o



12,5 mm		
1.250 x	2.000 mm	•
1.250 x	2.500 mm	o
600 x	2.000 mm	•
600 x	2.600 mm	•



Feuchtraum Typ H2		
12,5 mm		
1.250 x	2.000 mm	•
1.250 x	2.500 mm	o
600 x	2.000 mm	o
600 x	2.600 mm	•

Feuerschutz Typ DF		
12,5 mm		
1.250 x	2.000 mm	•
1.250 x	2.500 mm	o



Gipsfaserplatte			
		Rigidur	
10 mm	1.500 x	1.000 mm	•
12,5 mm	1.500 x	1.000 mm	o

Aquapanel	
Cement-Board In-Outdoor Die Naßraumplatte	
8 mm	
1.200 x	900 mm
	•



Renovierboard	
Faserverstärkte Feuchtraumplatte	
6,5 mm	
1.250 x	900 mm
	•



Glasfaser-Bewehrungsstreifen "Gazestreifen", 25 m	•
--	---

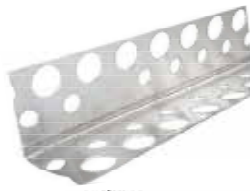

Alu Eckschiene 0,4 mm, 2,50 m	•
----------------------------------	---



Alu Abschluß "Göppinger" 1,0 mm, 2,50 m	•
---	---

PVC Abschluß weiß	•
----------------------	---

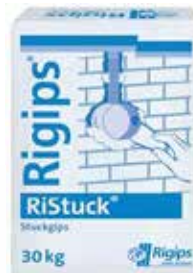
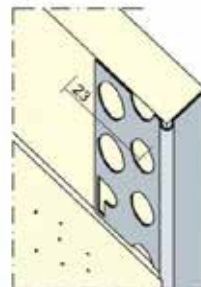

RiStuck Gips 30 kg	•
--------------------------	---



Rifix Ansetzbinder 30 kg	•
--------------------------------	---

Bauholz

Einschnitt nach
Tegernseer Gebräuchen



Windfederbretter	Glattkantbretter	
21 x 195 mm	21 x 73 mm	
5,10 m	3,90 m	4,20 m
o	•	o



Dachlatten sägerau (nicht S10/C24)

3 x 5 cm	(28 x 48 mm)
4,0 m	•
4 x 6 cm	(38 x 58 mm)
4,0 m	•
5,0 m	o
6,0 m	o



Schalung sägerau

24 x 160 mm	
4,0 m	o
5,0 m	•

Bohlen sägerau

40 x 200 mm	
4,0 m	o
5,0 m	•

Rauspund Nut+Feder

einseit. gehobelt Fi/Ta.	
21,5 x 121 mm	
3,60	o
3,90	•
4,20	o
4,50	o



Fasebretter

Fi/Ta.	
22 x 121 mm	
3,60	o
3,90	o
4,20	o
4,50	o

KVH

Konstruktionsvollholz	
aus Fi/Ta alls. Egalisiert	
techn. getrocknet auf 15%	
5,0 m lang	
60 x 80 mm	•
60 x 120 mm	•
100 x 100 mm	•



Zahlreiche Dimensionen
und Fixlängen lieferbar!

Teilw. auch
Zuschnitte möglich

Konstruktions-Latte

aus Fi/Ta alls. Egalisiert	
techn. getrocknet auf 15%	
4,0 m lang	
40 x 60 mm	•

Neu !

BSH

Brettschichtholz	
"Leimbinder"	
auf Anfrage	o



Dachfenster

Funktionelles Schwingfenster ?

Holz- oder Kunststoffrahmen ?



VELUX®



Oder :

Komfortables Schwing-Klappfenster ?



Verglasungsart ?



Eindeckrahmen



Zubehör: Innenfutter ? Rolläden ? Sonnenschutz ? Insektenschutz ?

Fenstergrößen und Ausstattungsmerkmale auf Anfrage.

Bodentreppen

Click-Fix 76

Wärmedämmter Lukendeckel U-0,49

70 x 110 cm	<input type="radio"/>
60 x 120 cm	<input checked="" type="radio"/>
60 x 130 cm	<input type="radio"/>
70 x 130 cm	<input type="radio"/>
70 x 140 cm	<input type="radio"/>



Lukenschutz-
geländer



Handlauf

DOLLE
...der sichere Weg nach oben!



Kniestocktür

Innenliegende Wärmedämmung

78 x 54 cm	<input type="radio"/>	78 x 68 cm
------------	-----------------------	------------

ZK - Türen



625 x 2000 mm LI	<input type="checkbox"/>
625 x 2000 mm RE	<input type="checkbox"/>

750 x 1875 mm LI	<input type="checkbox"/>
750 x 1875 mm RE	<input type="checkbox"/>

750 x 2000 mm LI	<input type="checkbox"/>
750 x 2000 mm RE	<input type="checkbox"/>

875 x 1875 mm LI	<input type="checkbox"/>
875 x 1875 mm RE	<input type="checkbox"/>

875 x 2000 mm LI	<input type="checkbox"/>
875 X 2000 mm LI / LAS 5	<input type="checkbox"/>
875 x 2000 mm LI / LAS 7	<input type="checkbox"/>

875 x 2000 mm RE	<input type="checkbox"/>
875 x 2000 mm RE / LAS 5	<input type="checkbox"/>
875 x 2000 mm RE / LAS 7	<input type="checkbox"/>

875 x 2125 mm LI	<input type="checkbox"/>
875 x 2125 mm RE	<input type="checkbox"/>

1000 x 1875 mm LI	<input type="checkbox"/>
1000 x 1875 mm RE	<input type="checkbox"/>

1000 x 2000 mm LI	<input type="checkbox"/>
1000 x 2000 mm LI / LAS 5	<input type="checkbox"/>
1000 x 2000 mm LI / LAS 7	<input type="checkbox"/>

1000 x 2000 mm RE	<input type="checkbox"/>
1000 x 2000 mm RE / LAS 5	<input type="checkbox"/>
1000 x 2000 mm RE / LAS 7	<input type="checkbox"/>

1000 x 2125 mm LI	<input type="checkbox"/>
1000 x 2125 mm RE	<input type="checkbox"/>

WICHTIG !
Anschlagrichtung
ermitteln.

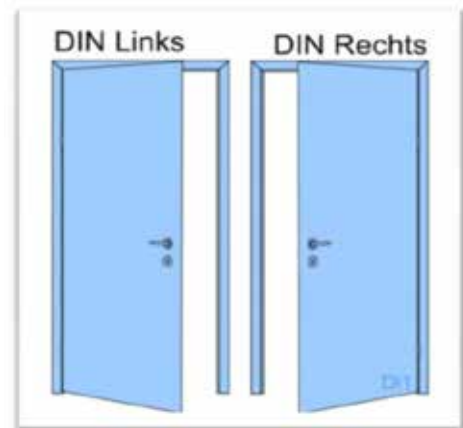

**Dämpfungsprofil
& Drücker inklusive
bei Tür-Element
(mit Eckzarge)**

Dämpfungsprofil



ZK-Drückergarnitur



Bild 5

**Mit Lichtausschnitt
OHNE Glas !**



Bild 7

FH - Klappen

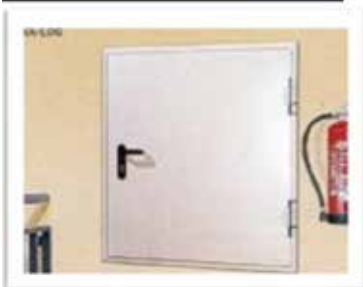

**RECHTS /
LINKS
VERWENDBAR !**

Stahl verzinkt + weiß grundiert

750 x 875 mm

875 x 875 mm

875 x 1250 mm

FH - Türen
mit Eckzarge



T30-1 H8-5		Dämpfungsprofil & Drücker inklusive bei Tür-Elementen (mit Eckzarge)	T30-1 H3 OD		
rechts/links verwendbar !			Anschlagrichtung angeben !		
750 x 1750 mm		o	Rauchschutztür, ohne Bodensteinstand, mit absenkbarer Bodendichtung, Universal-Eckzarge, Gleitschienen-Türschließer HDC35		
750 x 1875 mm		o			
750 x 2000 mm		o			
800 x 1800 mm		o			
800 x 1875 mm		o			
800 x 2000 mm		o			
875 x 1750 mm		o			
875 x 1800 mm		o			
875 x 1875 mm		o			
875 x 2000 mm		• o			875 x 2000 mm
875 x 2125 mm		o	875 x 2125 mm		
1000 x 1875 mm		o			
1000 x 2000 mm		• o			1000 x 2000 mm
1000 x 2125 mm		o			1000 x 2125 mm

Weitere Baureihen H3D, T90 sowie Zubehör (Obentürschließer ect. auf Anfrage !)

Stahl U-Zargen

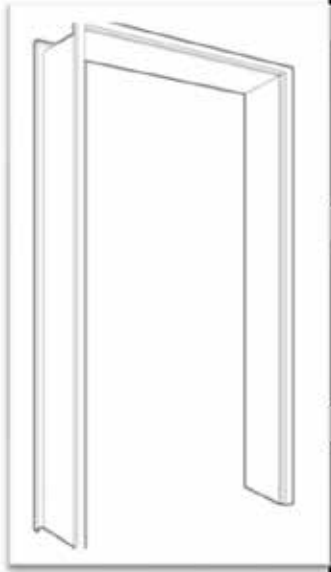

	Bandteile		
	o	V8100	
MW 130	750 x 2.000 mm		o
	875 x 2.000 mm		o
	1.000 x 2.000 mm		o
MW 145	750 x 2.000 mm		o
	875 x 2.000 mm		o
	1.000 x 2.000 mm		o
	875 x 2.125 mm		o
MW 205	750 x 2.000 mm		o
	875 x 2.000 mm		o
	1.000 x 2.000 mm		o
	875 x 2.125 mm		o
MW 270	750 x 2.000 mm		o
	875 x 2.000 mm		o
	1.000 x 2.000 mm		o
	875 x 2.125 mm		o

RECHTS / LINKS VERWENDBAR !

Weitere Größen auf Anfrage !

Eckzargen



625 x 2.000 mm RE	<input type="radio"/>
625 x 2.000 mm LI	<input type="radio"/>

750 x 1.875 mm RE	<input type="radio"/>
750 x 1.875 mm LI	<input type="radio"/>
750 x 2.000 mm RE	<input type="radio"/>
750 x 2.000 mm LI	<input type="radio"/>

875 x 1.875 mm RE	<input type="radio"/>
875 x 1.875 mm LI	<input type="radio"/>
875 x 2.000 mm RE	<input type="radio"/>
875 x 2.000 mm LI	<input type="radio"/>
875 x 2.125 mm RE	<input type="radio"/>
875 x 2.125 mm LI	<input type="radio"/>

1.000 x 1.875 mm RE	<input type="radio"/>
1.000 x 1.875 mm LI	<input type="radio"/>
1.000 x 2.000 mm RE	<input type="radio"/>
1.000 x 2.000 mm LI	<input type="radio"/>
1.000 x 2.125 mm RE	<input type="radio"/>
1.000 x 2.125 mm LI	<input type="radio"/>

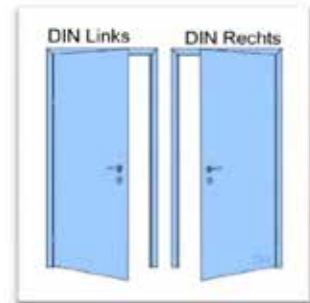

MZ-Stahltür

750 x 1750 mm	<input type="radio"/>
750 x 1875 mm	<input type="radio"/>
750 x 2000 mm	<input type="radio"/>

800 x 1800 mm	<input type="radio"/>
800 x 1875 mm	<input type="radio"/>
800 x 2000 mm	<input type="radio"/>

875 x 1750 mm	<input type="radio"/>
875 x 1800 mm	<input type="radio"/>
875 x 1875 mm	<input type="radio"/>
875 x 2000 mm	<input checked="" type="radio"/>
875 x 2125 mm	<input type="radio"/>

1000 x 1875 mm	<input type="radio"/>
1000 x 2000 mm	<input checked="" type="radio"/>
1000 x 2125 mm	<input type="radio"/>

Baustellen-Schutztür OVL

870 - 1160 x 1990 - 2210 mm



MZ Elemente mit Lichtausschnitt / Drahtglas					Regenleisten zum nachrüsten		
750 x 2.000 mm	875 x 1.875 mm	875 x 2.000 mm	1.000 x 1.875 mm	1.000 x 2.000 mm	750 mm	875 mm	1.000 mm
					<input type="radio"/>	<input type="radio"/>	<input type="radio"/>

Mehrzweckfenster

Kunststoff weiß

Breite	Höhe	PE	Piso
		Einfachglas	Isolierglas
60	40	o	o
60	50	o	o
80	40	o	o
70	50	o	o
80	50	o	o
80	60	o	o
100	50	o	o
100	60	o	o
100	70	o	o
100	80	o	o
100	100	o	o



PLUS Kipp

80	50		o
80	60		o
90	60		o
100	50		o
100	60		o
100	80		o
100	100		o
120	100		o

*Anschlagrichtung
angeben !
Din Rechts (Abbildung)
oder DIN Links*



MDK Drehkipp

Stahlkellerfenster verzinkt



Einflügelig

**5 mm dickes
ESG
Sicherheitsglas**

50	30	o
50	40	o
50	50	o
60	30	o
60	40	o
60	50	o
60	60	o
70	40	o
70	50	o
75	50	o
80	40	o
80	50	o
80	60	o
80	80	o
90	50	o
100	40	o
100	50	o
100	60	o
100	70	o
100	80	o
100	100	o
110	100	o
120	100	o

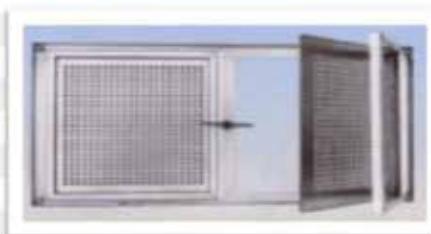

Zweiflügelig

Gitterroste

Normgitterroste aus fvz. Stahl

mit oder ohne
Zarge lieferbar !

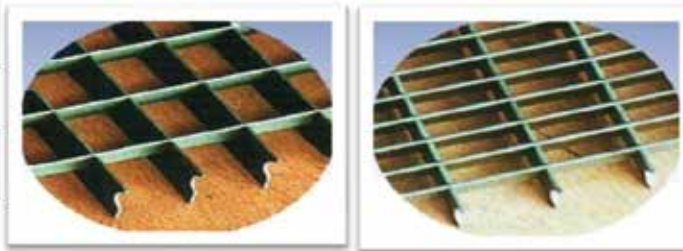

Breite	Länge	Maschenweite			
		30 x 30 mm			30 x 10 mm
		Höhe			Höhe
		20	25	30	20
300	500	o			o
400	600	o			o
400	700	o			o
400	800	o	o		o
500	800	o			o
400	900	o	o		o
500	900	o			o
400	1000	o	o	o	o
500	1000	o			o
400	1100	o	o	o	o
500	1100		o		o
600	800		o		o
600	900		o	o	o
600	1000		o	o	o
600	1100		o	o	o
500	1200		o	o	o
600	1200				o

Die Außenmaße der Gitterroste sind ca. 10 mm kleiner als das Zargenaußenmaß.

Fußabtreter

Winkelzarge verzinkt

60 x 40 cm	75 x 50 cm	100 x 50 cm
•	•	•
o	o	o
o	o	o
•	•	•
•	o	o
o	o	o

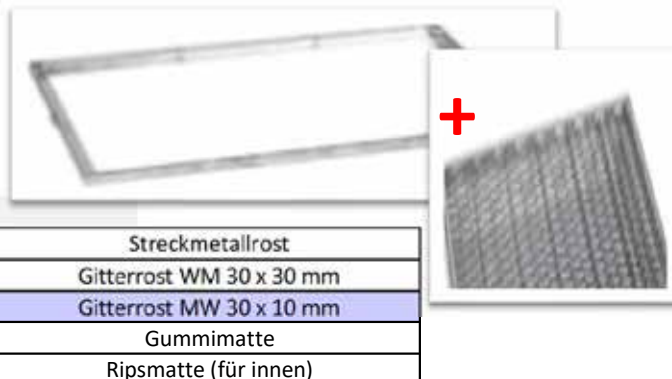

Abstreifkasten

AnrinSelf mit Winkelzarge

60 x 40 cm	75 x 50 cm	100 x 50 cm
•	•	•
o	o	o
•	•	•
o	o	o
o	o	o

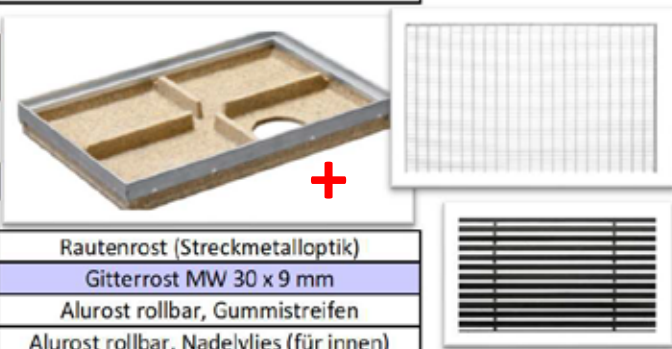

Lichtschächte aus GFK

Lichtschacht ohne Gitterrost

Breite x Höhe x Tiefe	PKW- Normale befahrbare	
	Ausführung	
81 x 66 x 43 cm	<input type="radio"/>	<input type="radio"/>
81 x 101 x 43 cm	<input type="radio"/>	<input type="radio"/>
101 x 66 x 43 cm	<input type="radio"/>	<input type="radio"/>
101 x 81 x 43 cm	<input type="radio"/>	<input type="radio"/>
101 x 101 x 43 cm	<input type="radio"/>	<input type="radio"/>
101 x 130 x 43 cm	<input type="radio"/>	<input type="radio"/>
126 x 101 x 43 cm	<input type="radio"/>	<input type="radio"/>
Breite x Höhe x Tiefe		
101 x 101 x 60 cm	<input type="radio"/>	<input type="radio"/>
101 x 131 x 60 cm	<input type="radio"/>	<input type="radio"/>
126 x 101 x 60 cm	<input type="radio"/>	<input type="radio"/>
126 x 131 x 60 cm	<input type="radio"/>	<input type="radio"/>
151 x 121 x 60 cm	<input type="radio"/>	<input type="radio"/>
175 x 80 x 60 cm	<input type="radio"/>	<input type="radio"/>
176 x 81 x 70 cm	<input type="radio"/>	<input type="radio"/>
200 x 120 x 60 cm	<input type="radio"/>	<input type="radio"/>



Rostausführung:

Streck-
metalloptik

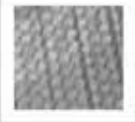

30 x 30
mm



30 x 10
mm

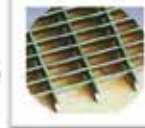

Aufsätze



Breite x Höhe x Tiefe		
81 x 35 x 43 cm	<input type="radio"/>	<input type="radio"/>
101 x 35 x 43 cm	<input type="radio"/>	<input type="radio"/>
126 x 35 x 43 cm	<input type="radio"/>	<input type="radio"/>
Breite x Höhe x Tiefe		
101 x 35 x 60 cm	<input type="radio"/>	<input type="radio"/>
126 x 35 x 60 cm	<input type="radio"/>	<input type="radio"/>
151 x 35 x 60 cm	<input type="radio"/>	<input type="radio"/>
175 x 35 x 60 cm	<input type="radio"/>	<input type="radio"/>
200 35 x 60 cm	<input type="radio"/>	<input type="radio"/>



Entwässerungsanschluß
mit Laubsieb NW 70



Lüftungsschacht

B x H x T

36,5 x 40 x 20 cm

Roste:

Streckmetall	MW 30/30	MW 30/10
<input type="radio"/>	<input type="radio"/>	<input type="radio"/>

Lüftungsschächte können beliebig übereinander gesetzt werden.

Lichtschächte aus Beton

B x H x T
100 x 40 x 20 cm



Nebeneingangstüren

Kunststoff



Holz



**Auch Sondermaße und
2-flügelige Elemente
lieferbar !**



Garagentore & Antriebe

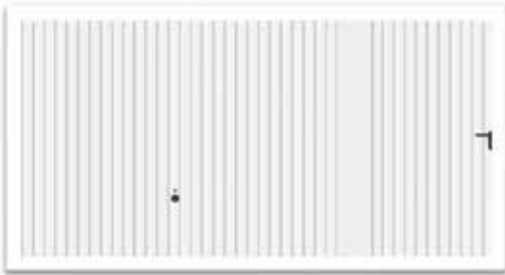

Aufgrund der Vielfalt dieses Sortimentes bitte separate Kataloge anfordern !



Zäune



Doppelstab-Gittermatten

4-Eck-Geflechte

Schmuckzäune



Pfostenträger fvz. H-Form, 600 x 5,6 mm	
71	•
81	o
91	•
101	•
111	•
116	•
121	•
141	•

Pfostenträger fvz. U-Form, 200mmDolle	
71	•
91	•
101	•
121	•

Pfostenträger L-Form, 200mm Dolle	
80	•



Holzzäune / Sichtschutz



Pfostenlasche U-Form, z. aufschrauben	
71 x 60/150	•
91 x 60/150	•
101 x 60/150	•

Pfostenlasche U-Form, z. aufschrauben	
71 x 50/200	•
91 x 50/200	•
101 x 50/200	•
121 x 50/200	•



Sturmanker "Kyrill"	
•	

Einschlaghülse 1,8 mm	
71 x 750 mm	•
91 x 750 mm	•



Sichtschutz aus WPC



Erdloch- ausheber ERD 280	
•	



Kunststoffzäune und Sichtschutz

Die Auswahl an Zäunen ist fast unüberschaubar. Lassen Sie sich von uns beraten oder fordern Kataloge an.

Erdloch- bohrer ERD 200	
•	



Atika Erdlochbohrer ELB 52	
•	

Dachziegel / Dachpfannen



Jacobi Dachziegel

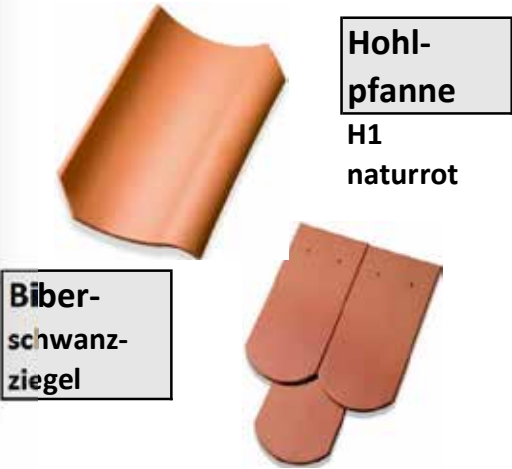

**Hohl-
pfanne**
H1
naturrot

**Biber-
schwanz-
ziegel**

Z5 Hohlfalzziegel



J11 Flachdachziegel



Braas Beton-Dachpfannen

Die Klassiker !



Doppel - S z.B. Klassikrot	Frankfurter z.B. Granit	Harzer Pfanne z.B. Dunkelbraun
--------------------------------------	-----------------------------------	--

Standroste	o
-------------------	---

Antennendurchgang	o
--------------------------	---



Dunstrohrpfannen	Traufenkamm	Firstrolle, 5 lfm
o	• 60/1000 mm	• rot anthrazit

Trapzebleche

Optima - ARAD

Dachfannen Paneelelement

Profilbreite: 1.176 mm

Deckbreite: **1.080 mm**

Paneelbreite: 350 mm



SZAFIR

Dachfannen Paneelelement

Profilbreite: 1.180 mm



Deckbreite: **1.100 mm**

Paneelbreite: 350 mm



Schrauben in allen Farben verfügbar!

Alle Bleche in verschiedenen RAL-Farben lieferbar !

Dachprofil				Wandprofil			
Profil T20M		Profil T35DR		Profil T20M		Profil T35DR	
1.138 mm	Profilbreite	1.080 mm		1.138 mm	Profilbreite	1.090 mm	
1.100 mm	Deckbreite	1.050 mm		1.100 mm	Deckbreite	1.050 mm	

Kantteile (Sonderformen möglich)



Ortgangblech 2m lang	
Schenkel	100 x 110 mm 150 x 150 mm

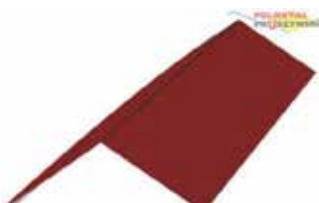

Firstblech 2m lang	
Schenkel	145 x 145 mm 200 x 200 mm



Pulldachfirst 2m lang	
Schenkel	100 x 110 mm 150 x 150 mm

Isopaneele /
Sandwichelemente
auf Anfrage !



Lichtplatten

Acryl

Profilplatten

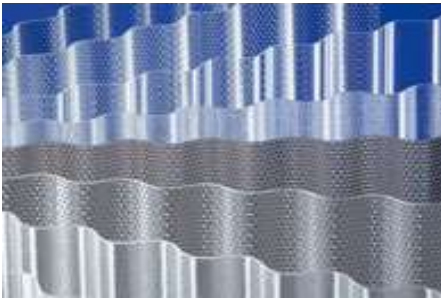

3 mm Stärke
brilliant in der Optik
langlebig und
witterungsbeständig



Breite:	Deckbreite:	Längen:					
1.045 mm	980 mm	2000 mm	3000 mm	4000 mm	5000 mm	6000 mm	7000 mm
		2500 mm	3500 mm				

PVC

Profilplatten



kostengünstig
und bewährt

Sinusprofil

76/18 mm, Dicke 1,1 mm

Breite:	Deckbreite:
1.160 mm	1.100 mm

Längen:

2000 mm	3000 mm	4000 mm	5000 mm	6000 mm
2500 mm	3500 mm			

Trapezprofil

70/18 mm, Dicke 1,1 mm

Breite:	Deckbreite:
1.160 mm	1.100 mm

Eternit-Profil

177/51 mm, Dicke 1,2 mm

Breite:	Deckbreite:
920 mm	870 mm

Längen:

2000 mm	2500 mm
---------	---------

Onduline-Profil

94/37 mm, Dicke 1 mm

Breite:	Deckbreite:
940 mm	890 mm

Längen:

2000 mm

Verlegezubehör

Firstprofile



Wandanschlußprofile



Abstandhalter



Spenglerschrauben



Kalotten

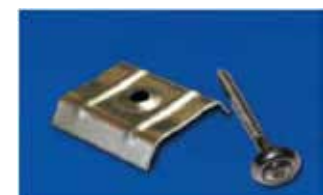

Kalotten m. Spengl.

Hohlkammerplatten

Acryl Stegdoppelplatten

hochste Transparenz & Brillanz
sehr gute Witterungsbeständigkeit
gute Wärmedämmeigenschaften
beste UV-Beständigkeit



Breite:	Längen:	
980 mm	2000 mm	2500 mm
	3000 mm	3500 mm
oder	4000 mm	5000 mm
1200 mm	6000 mm	7000 mm



klar - anti-drop 16	klar - anti-drop 16/64	opal-weiß 16	klar - anti-drop 16
höchste Transparenz	höchste Transparenz	gestreutes Licht	reduziert Hitzeentwicklung

Polycarbonat Hohlkammerplatten

hohe Bruchfestigkeit



klar 6	klar 10	klar 16	X 16
---------------	----------------	----------------	-------------



basis 16	thermo 25	sun stop 25	sun 32
-----------------	------------------	--------------------	---------------

Zubehör

Alu-Schraubprofil A1
 Randsprosse 60x42mm
 und
 Mittelsprosse 60x4mm



Abschlußwinkel	Edelstahlschrauben	U-Profil mit/ohne Tropfn.	Querpfettendichtung
-----------------------	---------------------------	----------------------------------	----------------------------

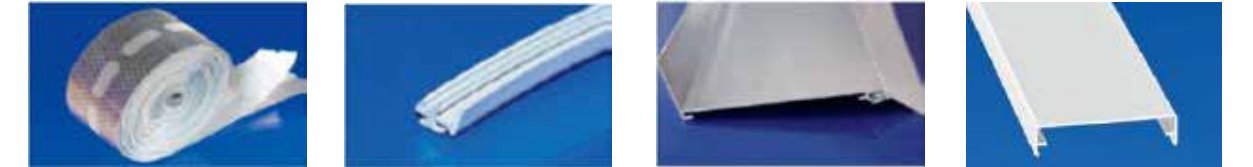

Kantenverschußband	Ersatzdichtung	Wandanschlußprofil	Alu Zier-Klemmdeckel
---------------------------	-----------------------	---------------------------	-----------------------------

Echtglas

**Verbund-Sicherheitsglas VSG
für Dach- und Wand
Innen und Außen**

Scoglas 8 mm

klar	weiß-matt
Breite:	800 mm
Längen:	bis 3.210 mm
	bis 4.600 mm
	bis 6.000 mm

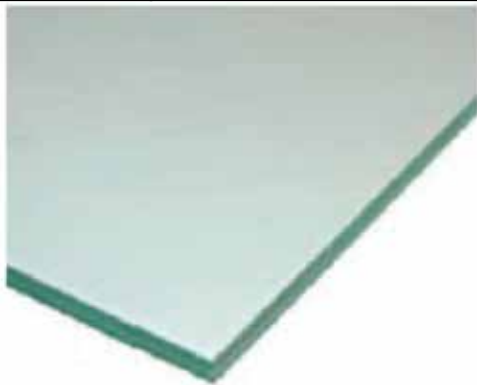

**Universalprofil A5
komplett mit Auflagegummi
und 2 hellgrauen
eingezogenen Dichtlippen
60 mm breit**

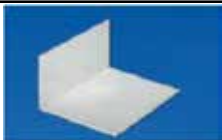

Abschlußwinkel A5 Edelstahlschrauben



Distanzclip 8-10
10 x 15,1 mm
2 bis 7m lang
im Zuschnitt



Bitumenbahnen



**Bitumenpappe
V13 besandet**
1 x 10 M

-
-
-
-



- Schweißbahn 1 x 5 M**
- V60 S4 blank
 - V60 S4 grün
 - V60 S4 + AL01



- Polymer-Bitumen-Schweißbahn**
- PYE PV 200 S5
 - blank 1 x 5 M
 - PYE PV 200 S5
 - grün 1 x 5 m
 - beschiefert



**Mogafix KSK-Uni
Kaltselfstklebahn**
1 x 10 M



auf Beton



auf Holz

RUTEX KSK-OWF für Holzaufbau

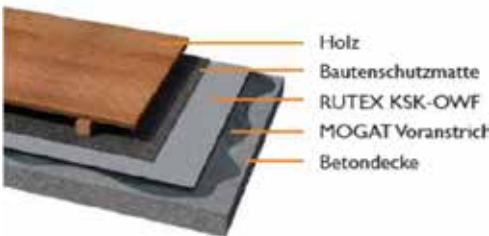

**Rutex KSK-OWF
selbstkl. Elastomerbit.**
1 x 7,5 M



Mit der RUTEX KSK-OWF steht eine selbstklebende, multifunktionale Elastomerbitumen-Oberlagsbahn in wurzelfester Ausführung zur Verfügung. Die RUTEX KSK-OWF eignet sich ideal für begehbare Balkone und Terrassen

Flachdachabschlußprofile

Briel Flachdach-Abschlußprofil



"Galant 100" 5m lang

- Farben:
- Aluminium
 - Anthrazit



2-teilig,
zuzüglich
Klemmprofil

Verbinder		Außenecke	Innenecke
Aluminium	<input type="checkbox"/>	Aluminium	<input type="checkbox"/>
Anthrazit	<input type="checkbox"/>	Anthrazit	<input type="checkbox"/>

Fassadenbaustoffe



Naturschiefer

20 x 20 cm Eckschnitt

rechts / links verwendbar

•

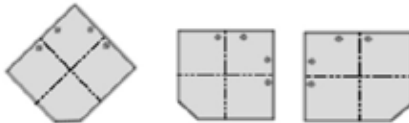

20 x 20 cm Bogen Universal

rechts / links verwendbar

o



25 x 25 cm Bogen Universal

rechts / links verwendbar

•

30 x 30 cm Bogen Universal

rechts / links verwendbar

o

30 x 20 cm Rechtecker

ungelocht

•

40 x 20 cm Rechtecker

ungelocht

•

60 x 30 cm Rechtecker

ungelocht

o

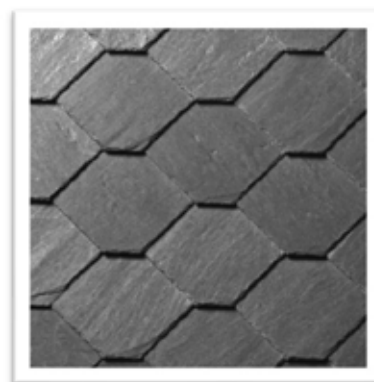

Verlegezubehör



**Spenglerschrauben A2
mit Dichtscheibe**

4,5 x 25 mm	100/Pak.	•
4,5 x 45 mm		•
4,5 x 65 mm		•

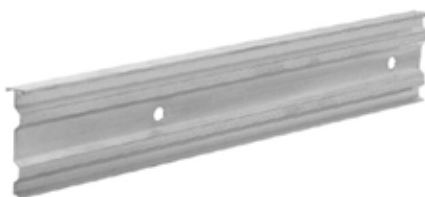

Alu Kappleiste 3m lang

Typ 200-SBG	•
Rundlochung 8mm Ø	



Walzblei 1,25 mm

3,50 m lang

25 cm	o
33 cm	•
50 cm	o
100 cm	o

Wakaflex

5m lang

28 cm breit	rot	•
	anthrazit	•



Venusblei 1,25 mm

3,50 m

**beidseitig veredelt
anthrazit / schwarz**

25 cm	o
33 cm	•
50 cm	o
100 cm	o



Zink Dachrinne

Traufblech	
3 m lang, 2 x gekantet	
200 x 0,7 mm	90°
•	•
•	110°
•	•

Traufblech
3 m lang, 3 x gekantet
500 x 0,7 mm

6-tlg DN 150	7-tlg DN 125	8-tlg DN 100
•	•	•

3,0 m lang

Rinnenhalter	6-tlg.	•
	7-tlg.	•
	8-tlg.	•

Außenwinkel	
6-tlg.	•
7-tlg.	•
8-tlg.	•

Endboden	6-tlg.	•
	7-tlg.	•
	8-tlg.	•

Innenwinkel	
6-tlg.	o
7-tlg.	o
8-tlg.	o

links/rechts	6-tlg.	•
	7-tlg.	•
	8-tlg.	•



Einlötstutzen	
6-tlg.	•
7-tlg.	•
8-tlg.	•

Einhangstutzen	
6-tlg./100	•
6-tlg./87	•
7-tlg./87	•
8-tlg./76	•

Rinnenverbinder	
6-tlg.	•
7-tlg.	•
8-tlg.	•



Fallrohr 2 m	
100 mm	•
87 mm	•
76 mm	•

Fallrohrmuffe	
100 mm	•
87 mm	•
76 mm	•

Rinnensieb	
	•

Standrohr	100 x 1000mm mit Reinigungsöffnung
	•

Standrohrkappe	
100/116	•
87 / 116	•
76 / 116	•

Fallrohrabzweig	
100 mm	•
87 mm	•
76 mm	•

Regenrohrklappe mit Laubsieb	
100 mm	•
87 mm	•
76 mm	•

Fallrohrbogen		
	72°	60°
100 mm	•	o
87 mm	•	•
76 mm	•	o

Fallrohrschelle mit Stift 140 mm	
100 mm	•
87 mm	•
76 mm	•

Löt看wasser ohne Abb.	
Z04 1ltr.	•

Standrohrschelle	
94 / 104 mm	•
für Schraubstift*	
*140 mm	•
*200 mm	•