

Fingerprint Recognition Door Lock

User's manual



SecuRAM™

SecuRam Inc. U.S.A.

Breakthrough in Biometric Technology →

Memo

WFS-07 Series Fingerprint Lock is specially designed for use in apartments and small offices. It applies a high performance algorithm to achieve speed identification and a very low False Rejection Rate (FRR) for a given False Acceptance Rate (FAR). It can identify a specific person (1:N) in 1 second with the storage of 30 fingerprints. The identification speed is 3 times faster compared to the other fingerprint locks in the same category.

WFS-07 Series Fingerprint Lock can be operated with passwords (6-14 digits) or an over-riding mechanical key. It is a stand-alone safety device and has a special feature - free passage function for office use.

Front Panel Diagram

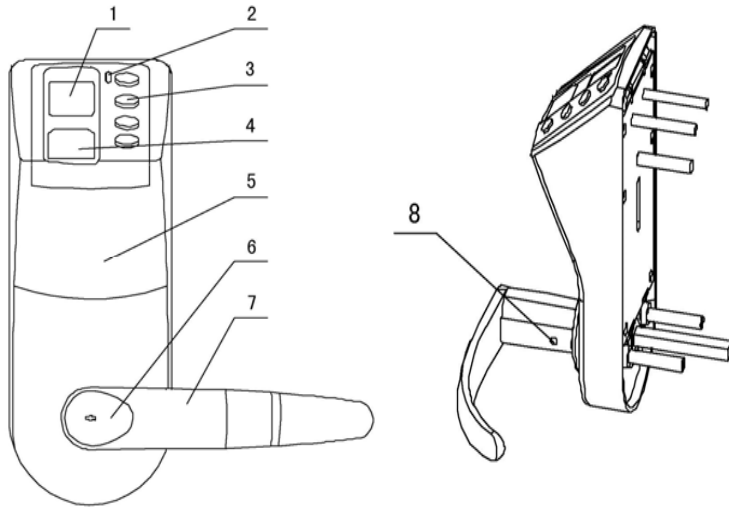

- ①: Fingerprint Reader Window
- ②: LED Indicator ③: Digital Pad
- ④: Display Screen ⑤: Front Panel
- ⑥: Cylinder Cover ⑦: Outside Lever Handle
- ⑧: Fixing Screw

- Battery Life Span ** : At least 1 year (assuming 10 uses of lock per day)
- Emergency Key Over-Ride Function : 8 pin key cylinder
- Dimension : 192mm X 72mm
- Operating temperature : -10°C - 65°C
- Operating humidity : 10% - 85%

- Due to the difference in battery capacity, the fingerprint lock is tested based on 500mA.h battery capacity.

SPECIFICATIONS:

➤ Verification Time : 1.0 s

➤ ***Registration Capacity:***

30 fingerprints + 30 passwords

➤ FRR : <0.1%

➤ FAR : <0.0001%

➤ Password length : 6-14 digits

➤ Standby current : 30 μ A (Typical)

➤ Power supply : 4 AA-size alkaline batteries or

4 AA-size rechargeable batteries

(1.2V 1800mA.h)

Back Panel Diagram

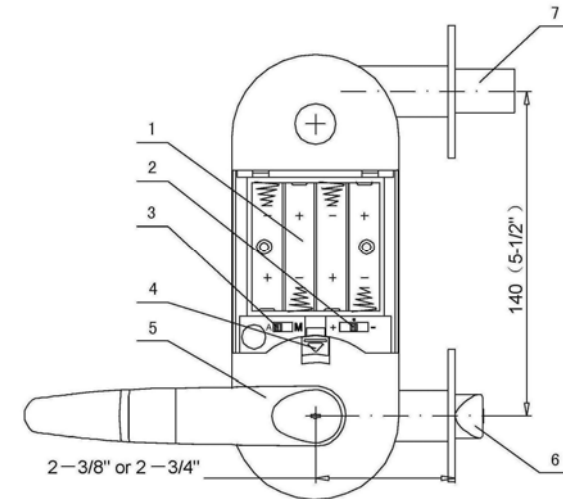

- ①: Battery Case
- ②: S1---Function Switch
- ③: S2---Unused
- ④: Battery Cover Fastener
- ⑤: Inside Lever Handle
- ⑥: Regular Latch
- ⑦: Deadbolt (option)

Contents

1.Quick start.....	7
2.Enrol additional fingerprints	10
3.Unlock by an enrolled fingerprint.....	12
4.Set password (code) by an enrolled fingerprint	13
5.Unlock by an enrolled password (code).....	15
6.Change the enrolled password (code).....	16
7.Delete all fingerprints and passwords (codes)	18
8.Delete a specific user's fingerprint and password..	19
9.Passage Mode Function	20
10.Deadbolt functions (optional).....	21
11. Display information of lock	23
12.Use the overriding mechanical key to unlock.....	24
13.Low battery indication	25
14.Basic agreement	26
15.Form of error information	27





15. Form of error information

Error Code	Error Type
E0	Error of registering fingerprint; it is caused by wrong placing of finger on the reader window
E1	Fingerprint having been registered already: Note: The same fingerprint cannot be repeatedly registered.
E2	Error of EEPROM in CPU: If it happens repeatedly, the lock needs maintenance
E3	Error in fingerprint module when canceling fingerprint: If it happens repeatedly, the lock needs maintenance
E4	Error of fingerprint module, if it happened repeatedly, the lock needs maintenance
E5	No fingerprint in the lock
E6	Inadequate authority to access
F0	Full fingerprints: no more fingerprint can be registered
B0	Low battery. It needs to be replaced

14. Basic agreement

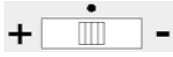
- 14.1** Long pressing usually stands for confirming.
- 14.2** Two beeps stand for confirming sound (one program has been finished, e.g. finish inputting password or registering fingerprints)
- 14.3** One beep means approval sound (e.g. press a button or finish inputting one fingerprint)
- 14.4** Long beep stands for error happened.

1. Quick start

- 1.1** Switch S1(located under the battery cover) to the center position 
- 1.2** Install the batteries (recommend to use high quality Alkaline batteries, e.g. Duracell, Energizer), the display screen will show ,  and the version of lock  which means this model can accommodate up to 10 fingerprints (30 for F30 ,99 for F100) and no fingerprint is yet enrolled and the version of lock is 1.0 .
- 1.3** Push  to wake up the lock, then place the finger on the reader window and hold till two beeps sound and blue light is on.
- 1.4** Remove the finger and display screen will show

fingerprint ID  if the enrollment is successful.

1.5 If display screen shows , it means enrolling is not successful. In this case, repeat **1.3** to **1.4**.

1.6 If display screen shows , it means this fingerprint has already been enrolled.

1.7 Push  to wake up the lock, then place the enrolled finger on the reader window and hold.

1.8 The reader window will light up (red).

1.9 If verifying is successful, 2 beeps will sound and LED indicator blue light will be on.

1.10 Remove finger and turn down the handle to open the door.

1.11 The next enrolled fingerprint ID # is 02. Please follow the steps below:

13. Low battery indication

If the batteries are low, when unlocking, the display screen will show  and follow by a beep warning sound.

Please replace the batteries as soon as possible.

12. Use the overriding mechanical key to unlock

- 12.1** Insert the cylinder-cover-removal tool to remove the plastic oval cover.
- 12.2** Insert the key and turn clockwise 90°.
- 12.3** Turn the lever handle to open door.
- 12.4** After unlocking the lock, turn the key back to the original position to remove the key.

1.11.1 Switch S1 to center position  .

1.11.2 Push  to wake up the lock, then unlock the lock by the enrolled fingerprint which ID must be 01.

1.11.3 LED indicator shows blue light blinks (DO NOT TRUN LEVER HANDLE)





1.11.4 Press the  keypad and hold till the display screen shows  .

1.11.5 Place the finger on the reader window, till 2 beeps sound and the blue light is on. The fingerprint has been enrolled successfully.







Note :

The default password (123456) will be deleted automatically for the safety after the first fingerprint is enrolled and used to open the door successfully.

2. Enroll additional fingerprint

- 2.1** Switch S1 to center position  ,
- 2.2** Push  to wake up the lock, then unlock the lock by the enrolled fingerprint which ID must be 01 or 02.
- 2.3** LED indicator shows blue light blinks (DO NOT TURN LEVER HANDLE).
- 2.4** Press the  keypad, till the display screen shows  .
- 2.5** Place the finger on the reader window, till 2 beeps sound and the blue light is on. The fingerprint has been enrolled successfully.

II. Display information of lock

- 11.1** Press  or  to wake up the lock.
- 11.2** Input  and then press  and hold till 2 beep sound and the display screen will show  ,  and the version of lock  which means this model can accommodate up to 10 fingerprints and no fingerprint is yet enrolled and the version of lock is 1.0.

- ③ The reader window will light up (red).
- ④ If verifying is successful, 2 beeps will sound while the indicator blue is on.
- ⑤ Remove the finger, and pull up the Outside Lever Handle.
- ⑥ The deadbolt automatically extrudes. Now, the door is locked with deadbolt.
- ⑦ To unlock the door, repeat the steps ② to ④, and then remove the finger, pull down the Outside Lever Handle, then the regular latch and the deadbolt will withdraw back simultaneously, and the door is unlocked.

Note :

Only one fingerprint can be enrolled at a time. If several fingerprints need to be enrolled continuously, switch S1 to the **plus** position : 

3. Unlock by an enrolled fingerprint

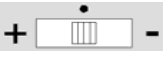
3.1 Switch S1 to center position  .

3.2 Push  to wake up the lock, then place the enrolled finger on the reader window and hold it.

3.3 The reader window will light up (red).

3.4 If verifying is successful, 2 beeps will sound and indicator blue light will be on.

3.5 Remove finger and turn down the handle to open door.

10. Deadbolt Functions (optional)

10.1 To operate inside the room:

① After the door is closed, pull up the Inside Lever Handle.

② The deadbolt automatically extrudes. Now, the door is locked with the deadbolt.

③ To unlock the door, pull down the Inside Lever Handle, then the regular latch and the deadbolt withdraw back simultaneously, and the door is unlocked.

10.2 To operate outside the room:

① Close the door.

② Push  to wake up the lock, then place the enrolled finger on the reader window and hold.

9. Passage Mode Function

9.1 Press or to wake up the lock, then unlock the lock with enrolled fingerprint or password. Press and hold while blue light blinks till 2 beeps sound with the display screen showing . Now the lock is set to a passage mode (open all the time).

9.2 If you push the lever handle down after unlocking (with fingerprint or code), the lock will then be back to a normal (locked) status.

9.3 If you do not push the lever down after unlocking, the lock will also go back to a normal status after 5 sec.

4. Set password (code) by an enrolled fingerprint

4.1 Switch S1 to center position

4.2 Push to wake up the lock, then unlock the lock by the enrolled fingerprint which ID must be 01 or 02.

4.3 Press and hold till the display screen shows .



4.4 Put the enrolled finger which wants to set a password on the reader window.

4.5 If succeed to verify, the LED screen will display the ID then follow .

4.6 Input the password (6-14 digits).

4.7 Press and hold till the display screen shows .

4.8 Repeat the password (enter the password again).

4.9 Press   and hold till the display screen shows the ID of this password.



4.10 This password is now set.



Note :



The password set can not be the same as default password which is '123456'.



8. Delete a specific user's fingerprint and password (code)

8.1 Switch S1 to center position .

8.2 Press  or  to wake up the lock, then unlock the lock by the enrolled fingerprint or password which ID must be 01 or 02.

8.3 Press  and hold till 2 beep sound with the display screen showing  and then the first enrolled ID No. except ID No. 01 or 02 used to unlock the lock.

8.4 Use  and  to choose the ID No. to be deleted.

8.5 Press   and hold till 2 beeps sound with the display screen showing ID No. and then  which means the fingerprint and the password are now deleted.

7. Delete all the fingerprints and passwords (codes)

7.1 Switch S1 to the **minus**  position.

7.2 Press  to wake up the lock, then place any finger on the reader window.

7.3 The display screen will show .

7.4 Press  and hold till 2 beeps sound with the display screen showing the IDs are being deleted one by one.

7.5 Wait till the display screen shows the  again.

7.6 The deletion is now completed.

Note 

The default password is again set back to default password 123456 with ID No. 01 after the above deletion process.

5. Unlock by an enrolled password (code)

5.1 Press  to wake up the lock.







5.2 Simply press the correct password and the display screen will show the ID number.

5.3 Now the lock can be unlocked by turning down the lever handle.



Note 

For the above process, the S1 switch can be on any position.

6. Change the enrolled password (code).

- 6.1** Press  or  to wake up the lock, then unlock the lock by the enrolled fingerprint or password, respectively.
- 6.2** The display screen will show the ID number.
- 6.3** Press  and hold.
- 6.4** The display screen will show .
- 6.5** Input the new password. Press  and hold, the display screen will show .
- 6.6** Repeat the new password (enter the password again).
- 6.7** Press  and hold, the display screen will now show the ID number.
- 6.8** The password is now changed.

Note 

If to press  and hold directly after shows  and , the password will be deleted.

To change the password which ID is 01 or 02, please refer to the [4](#).

 There are 4 key pads with

1, 2, *, as one

3, 4, 5, as one

6, 7, 8, as one

and 9, 0, #, as one

This is for the convenience of the user.

Example If the password is 87615983, the input of

the key pads will be:

