



Installation Manual Generation II Yamaha Royalstar Venture 1999-2013

**Copyright 2015 Pete Giarrusso, Inc.
D/B/A Chopper Design Services
All Rights Reserved**

Table of Contents

INTRODUCTION	4
WARRANTY	5
INSTALLATION INSTRUCTIONS	6
COMPONENTS:	6
PREPARE FOR INSTALLATION	7
CONTROL SWITCH BOX	8
LEG & MOUNT ASSEMBLIES	14
RUNNING AIR LINES	15
INSTALL THE COMPRESSOR	16
INITIAL SYSTEM TEST	18
MOUNT PROXIMITY SENSOR	19
WIRE ROUTING	20
FINISHING UP	22
<i>FINAL ADJUSTMENTS & MAINTENANCE MODE</i>	24
<i>MAINTENANCE MODE</i>	24
<i>WHEEL ADJUSTMENT</i>	25
TEST RIDE	28
ILLUSTRATIONS	30
HARDWARE LIST	31

Introduction

This manual covers installation of the Generation II LegUp LandinGear system by Chopper Design Services. This system should only be installed by a qualified technician, or those with above average mechanical skills. If you are not **SURE** that you can perform this installation, please contact us and we will help you find a qualified shop to assist you.

While the Generation II System holds your bike upright very well, you are **STILL** responsible for balancing the bike! The system **WILL** relieve you of some of the weight of the bike and help you avoid balance problems as you approach a stop, maneuver at slow speeds, and back the bike up.

Improper installation will void your warranty, so please be very careful!

Thanks for choosing LegUp!

Warranty

Chopper Design Services warrants the LegUp system for a period of one year from date of purchase. This warranty covers replacement parts and/or manufacturer defects. Incidental damages or costs are the responsibility of the purchaser.

Defective parts are to be returned to Chopper Design at the address below. Purchaser must contact Chopper Design to receive a Return Material Authorization, prior to returning defective parts to Chopper Design.

Abuse, improper installation or use, collisions or accidents, are not covered under this warranty. Replacement parts for this type of damage are available through Chopper Design.

Users of the LegUp system agree that Chopper Design is **NOT** responsible for personal injuries or damage to property arising from the use of the system. While we believe this system to be safe and reliable, the user is advised that use of LegUp is done so at the users' own risk. Use of the system implies agreement to the above statements. If you can't agree with the above, Chopper Design and its dealers would be happy to refund your full purchase price, before you install the LegUp System.

Chopper Design Services
1365 Bennett Dr. #101
Longwood, FL 32750

407-834-5007
LegUp@LandinGear.com

Installation Instructions

The LegUp® system has many components. Please be sure you have them all before starting your installation.

COMPONENTS:

- 1) Wire Harness W Switch Box
- 2) Leg and Mount Assembly (L/R)
- 3) On-board Computer Module
- 4) Proximity Sensor
- 5) Saddlebag Mounted Compressor System
- 6) Hardware Bag

If you believe you are missing any parts, please contact Chopper Design at 407-834-5007, and we will rectify the situation.

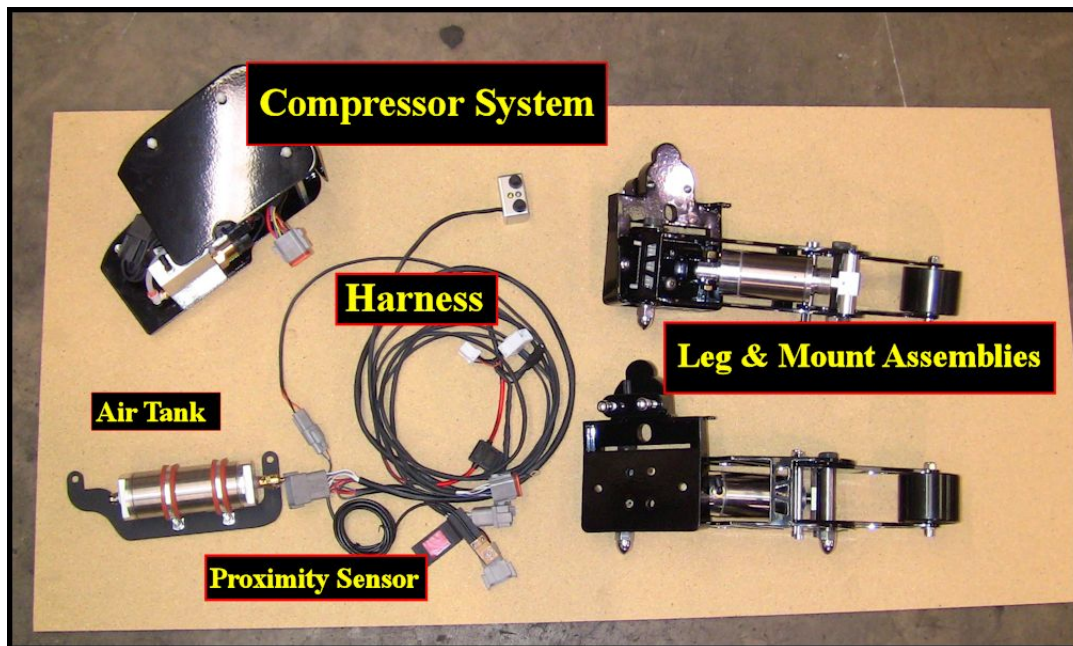

Figure 1

PREPARE FOR INSTALLATION

Place the motorcycle on an acceptable bike lift. You will need to keep the bike on its wheels for most of the installation, and jack the rear wheel off the lift for some portion of the installation. Make SURE the motorcycle is secure on the lift!

Remove the seat and both saddlebags; they won't be needed until the installation is complete.

NOTE: The suspension on the RoyalStar is so soft, if the wheels are deployed without the rider's weight on the seat, the bike will lean on one wheel or the other! This is how it is as the suspension rises a few inches without a rider in the saddle. The legs will still hold the bike up. Refer to the 'User's Manual' for more information.

This manual is available at <http://landinggear.com/pdf/G2installRoyalstar.pdf> . It may be easier to see some of the pictures in color there!

We are now ready to begin!

CONTROL SWITCH BOX

The switch box should already be mounted to a black mounting plate. The switch box mounts under the left mirror.

First dismantle the plug, so you can run the wires where they need to go. Next, remove the left mirror, and the adapter. Slide the adapter through the hole on the switchbox plate, and with some Loctite, tighten the adapter back down to the hand control. Make sure the switchbox is square to the bike before final tightening. You can then reinstall the mirror.

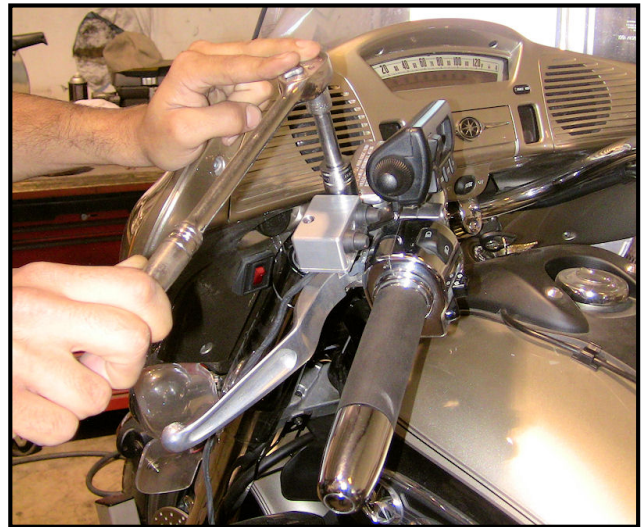

You will need to run the wire over the clutch perch, down the handlebar, over the top of the triple-tree, then back under the edge of the tank to end up under the seat area. We removed the bottom clip that holds the plastic cover in front of the tank, so we could slide the wire from under the bars, under the plastic before running it under the tank. You need to make sure you have enough slack to put the plug back on, after the wire is under the seat area!

Reassemble the 6 or 8-pin connector using the diagram on the next page, making sure that the colors match perfectly. Sometimes it is smart to plug the harness in to verify perfect reassembly. Now onto the rest of the wiring harness!

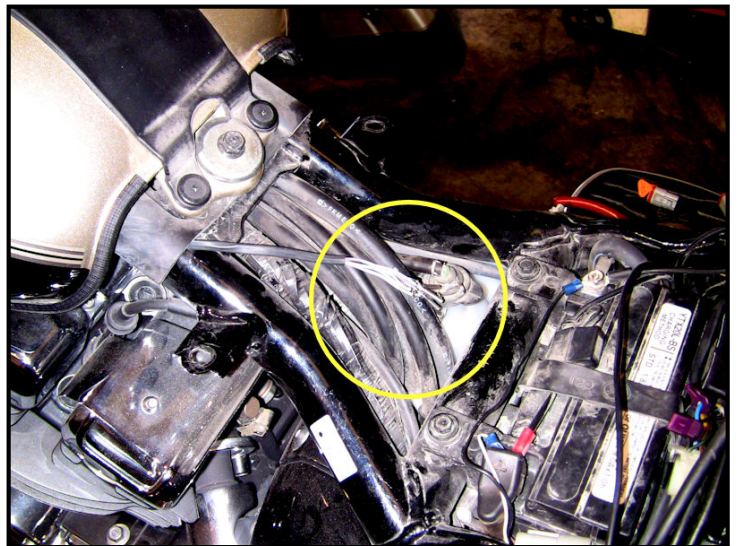
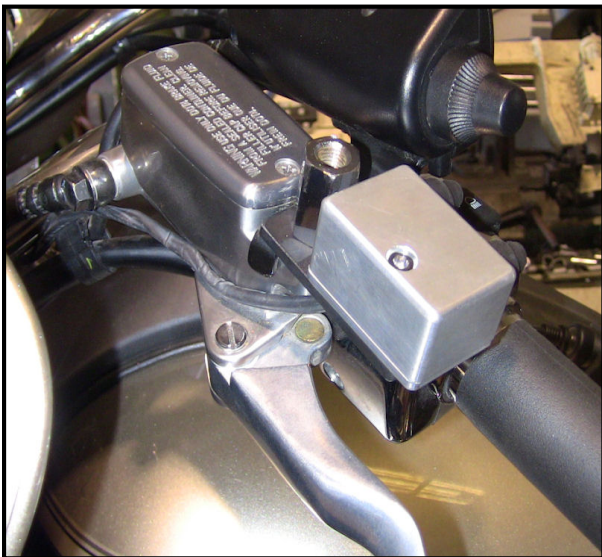

Pin Out for Handlebar Control Box Plugs

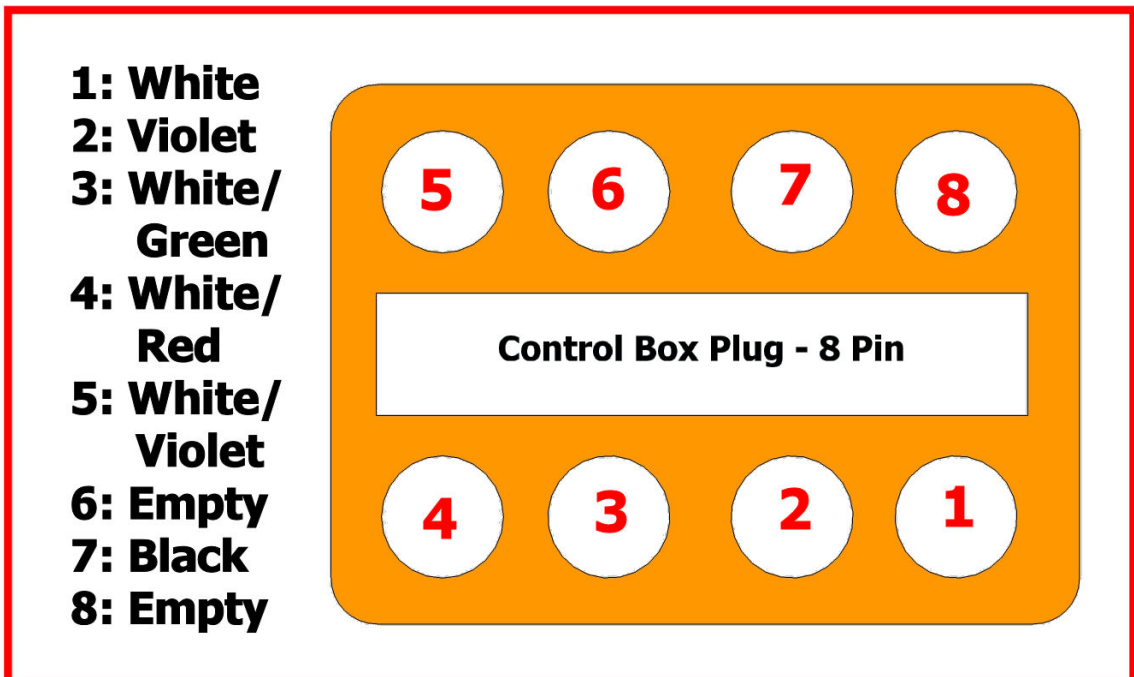
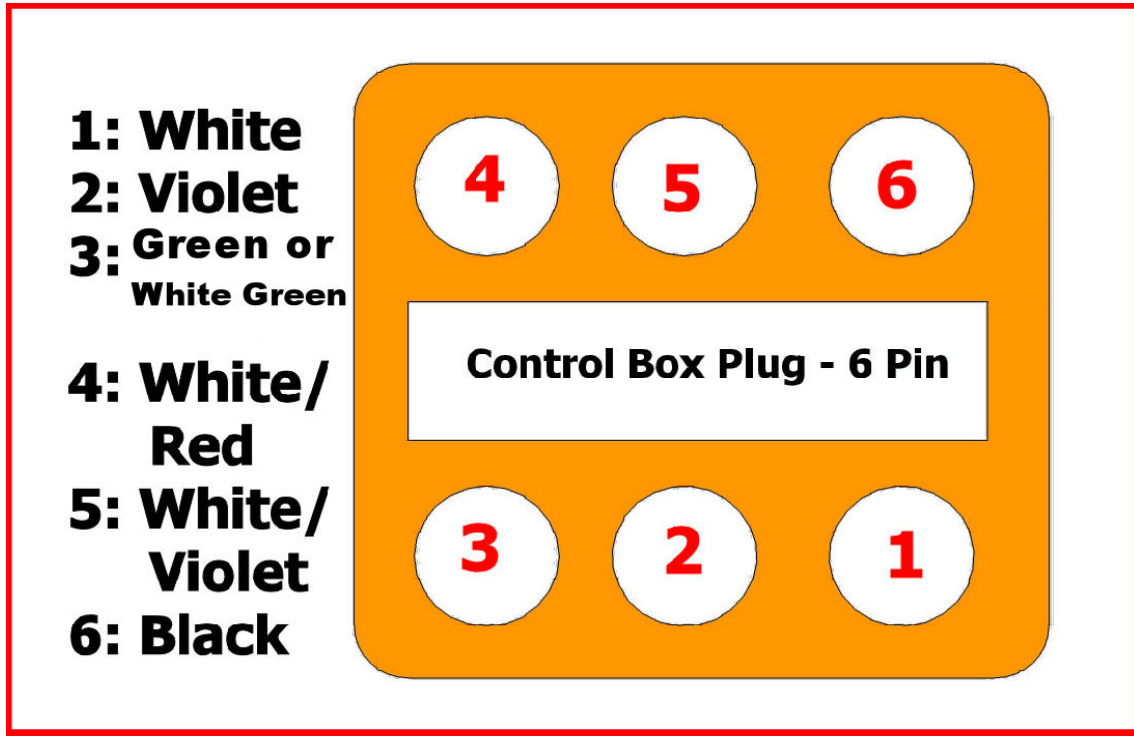

WIRING HARNESS

The next step is to route the wiring harness. The harness and the plugs are routed mostly under the seat and left saddlebag.

First we need to make a small notch in the left saddlebag to allow the wire and air lines for the computer and compressor to enter the bag without being crushed. We used a rotary tool, but a round file or small saw would work as well.

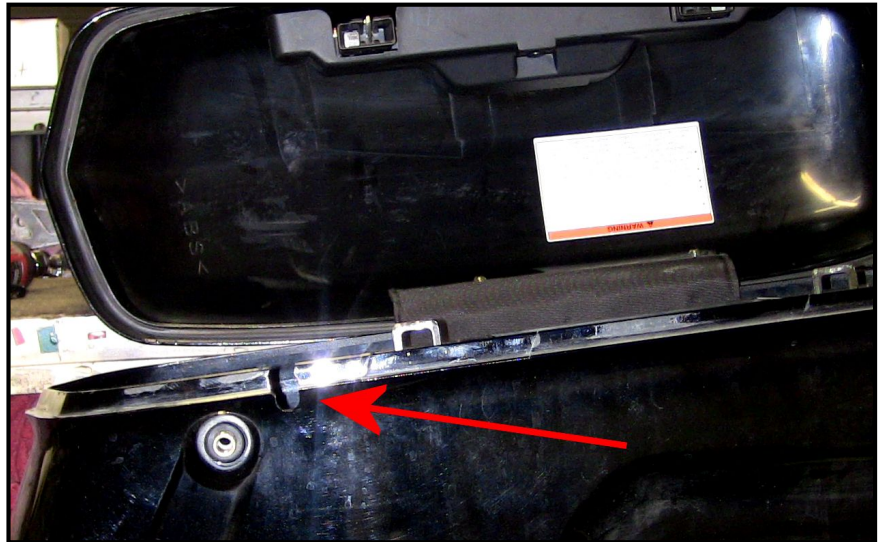

The notch is positioned as seen in the photo. It is approximately 1/2" wide and just over 3/4" long. Notice that it extends just below the lip that the top cover mates to. This is very important! Otherwise the lid would crush the wire. It goes without saying that this notch is on the inside, or back-side of the bag. Set the bag aside as we won't need this until the very end.

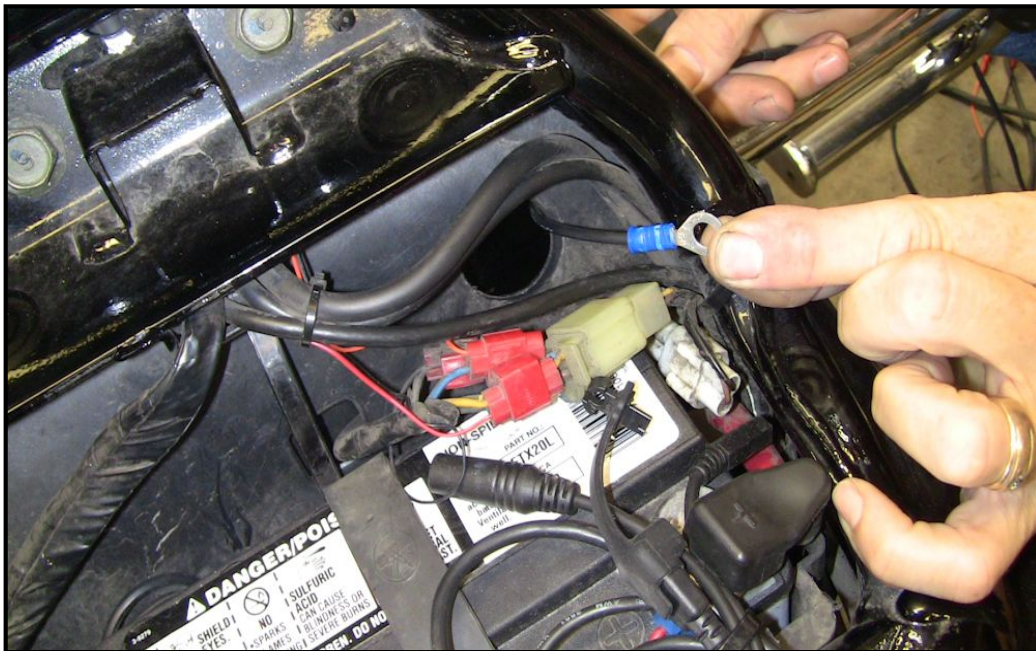

Next we remove the rubber plug behind the battery on the left side to allow us to run the harness under the seat from the back of the bike.

The 8 pin connector should have been disassembled for you, and we usually run the 3 pin plug, then the 8-pins of wire for the 8-pin connector, then the two hoop connectors (opening the fuse holder makes it

easier), and the two spade plugs through the hole in that order.

Once these are all through we want to connect the red hoop connector with fuse holder to the positive side of the battery (we like to pull the fuse out for safety), and the black hoop connector to the negative side of the battery.

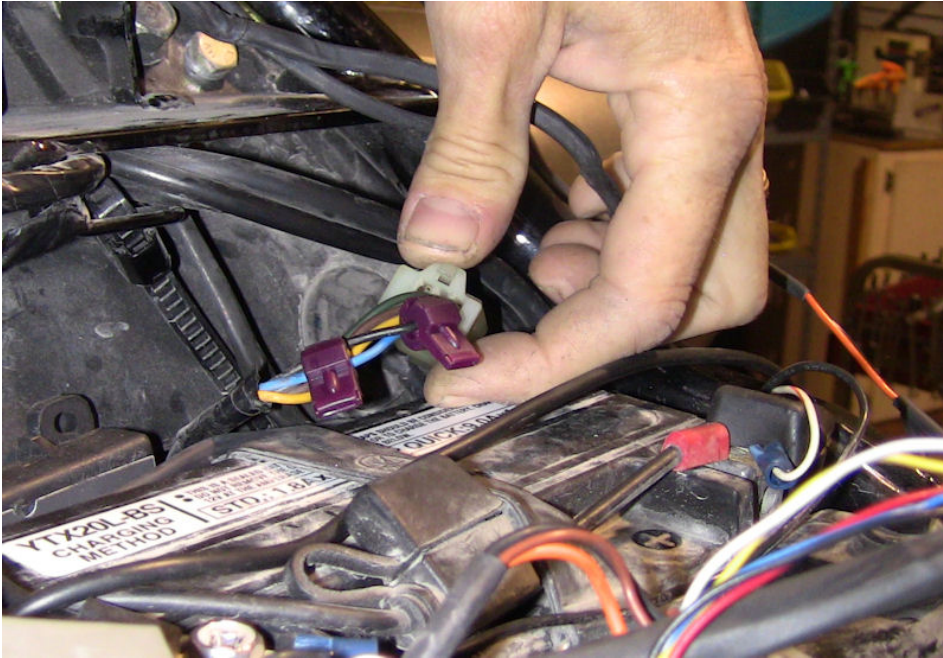

The next step is for us to get the power connections to the bike. Find the white plug under the seat. We need to install the purple/blue plugs over two of the wires attached to the plug.

Wrap one of these snap-together connectors around the blue wire, and another around the black (later harnesses don't have the black wire). These connectors will snap closed and become a spade connector we attach our power leads to.

On the harness, you will find two red plugs; one is attached to an orange wire and the other to a black wire (again, on later harnesses, this line is not needed; the ground has been bonded at the battery connector). Carefully plug the orange wire on the connector attached to the blue wire, and the black one on the black wire from the bike. Make sure you don't have these backwards!

For you technical types, the blue wire is switched 12 volts for the taillight, and the black is ground. This is how the system is initialized once the key is turned on.

We now want to get the three pin plug that is attached to the speed sensor (little yellow block on a metal bracket) up from the right side rear brake area, to the area under the seat.

Put the sensor and bracket near the rear brake, and run the wires up to the seat area. You should be able to squeeze this up from the bottom with the plug on, as you can see in the picture on the next page.

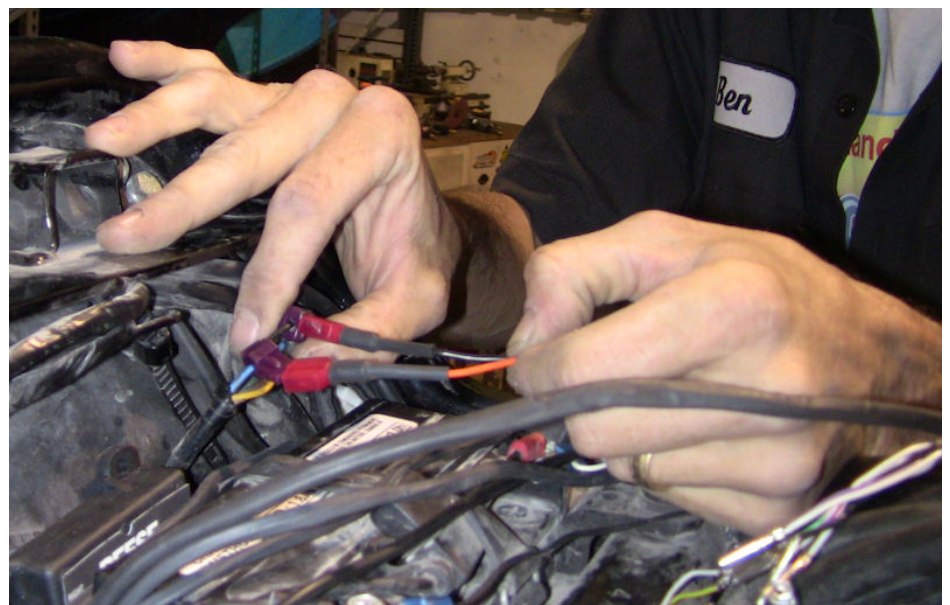

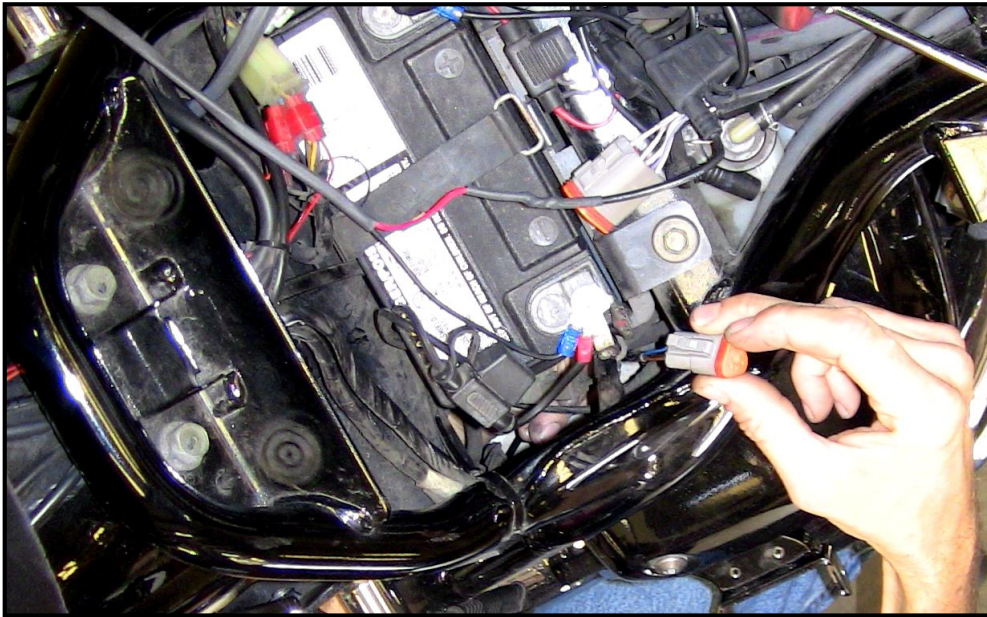

We ran the wire along the swing arm and it will be tied along the brake line later. Leave a bit of slack as you aim the wire up to the right side of the battery under the seat.

If you had to take the plug apart to run these wires, reassemble the plug, but be careful. This is a three position plug, so it is VERY easy to wire incorrectly. Refer to the diagram here plug this into its mating

and take note of the wires are on the sensor side. It may be easier to plug this into its mating plug to verify the colors.

NOTE: We will mount this bracket in this area later, but making sure you have enough wire to mount it and that the extra slack is pulled to the under seat area!

We should be able to plug in all the connectors under the seat. No need to clean it all up, just plug in the 8 pin plug from the handlebar switches to its mate and the three pin plug to its' mate.

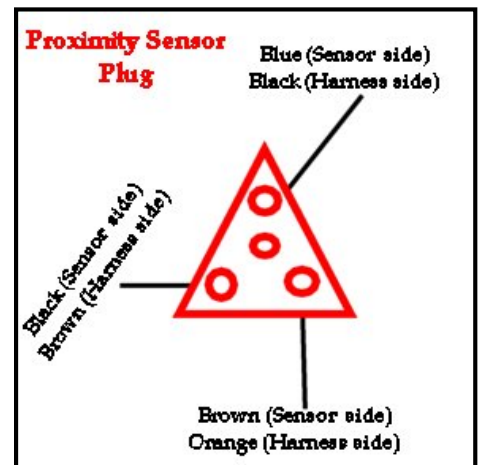

Due to global distributions problems, we may have to use a four pin plug instead of a 3 pin plug. The colors still need to be the same across the plugs with pin 4 empty!

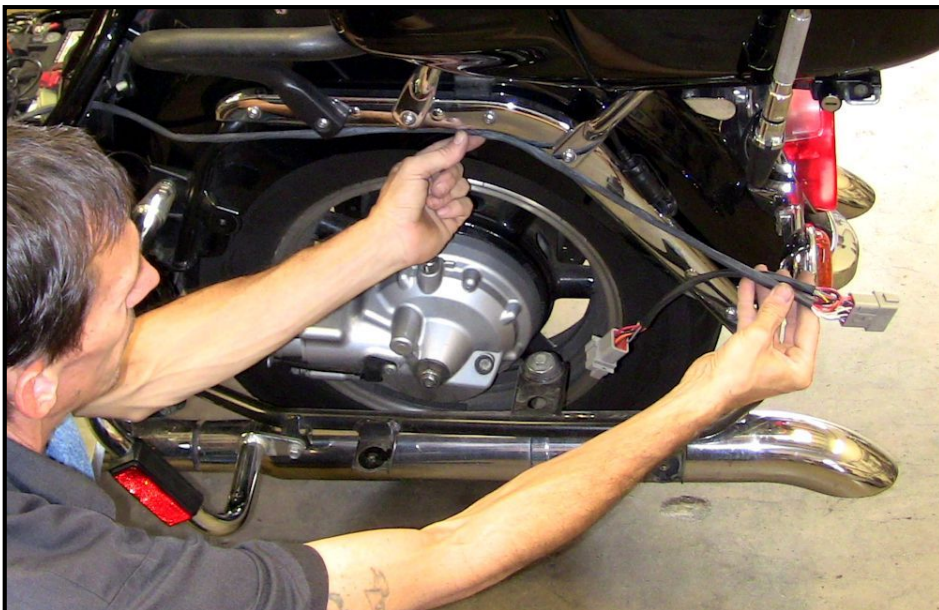

Next pull the wires on the left side as shown here, and tie them to the fender rail loosely. We will tie our air lines to them as we get ready to put the bag back on. We want about 17" of wire extending from the rear upright to the 12-pin plug on the harness.

Once you have this, tie the harness firmly to the fender rail. You can now pull the extra wire back into the under seat area. Later we will be securing air lines to this wire, so make sure that will be possible with your choice of how to attach this wire!

The only wires dangling should be the two wires on the left side for the compressor system, and the speed sensor on the right!



Let's move on to mounting the legs!

LEG & MOUNT ASSEMBLIES

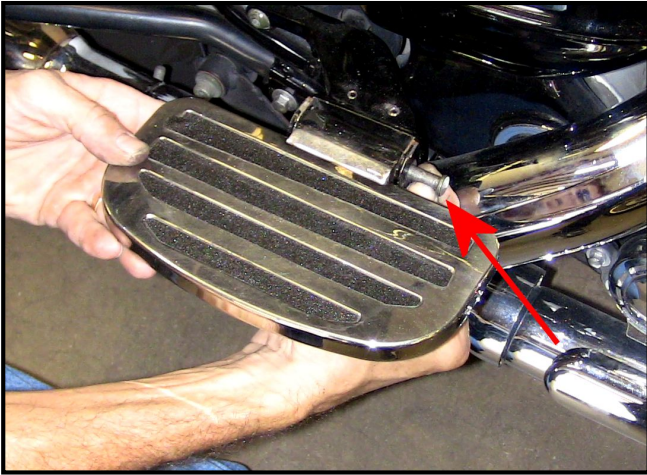

In order to mount the legs, we must first remove the passenger floorboards. This is accomplished by removing the c-clip on the end on the pin that holds the floorboards on. Once the c-clip is removed, slide the pin out. You will find a small ball bearing and a plate on one side of the floorboard that will become free as the floorboard comes loose.

We don't need any of these pieces, but you may wish to keep them if you remove the system in the future.

With the floorboard off, find the appropriate leg for the side you are working on (right side shown here), and gently slide it on, allowing the ears from the floorboard mounts to slide through the slots in the leg. This is a tight fit, so it may take some wiggling.

Once the leg is mounted, find the long 5/16" (3.25" at least) bolt, and run it through the mounts on the bike and the legs. Cap the bolt with a lock nut.

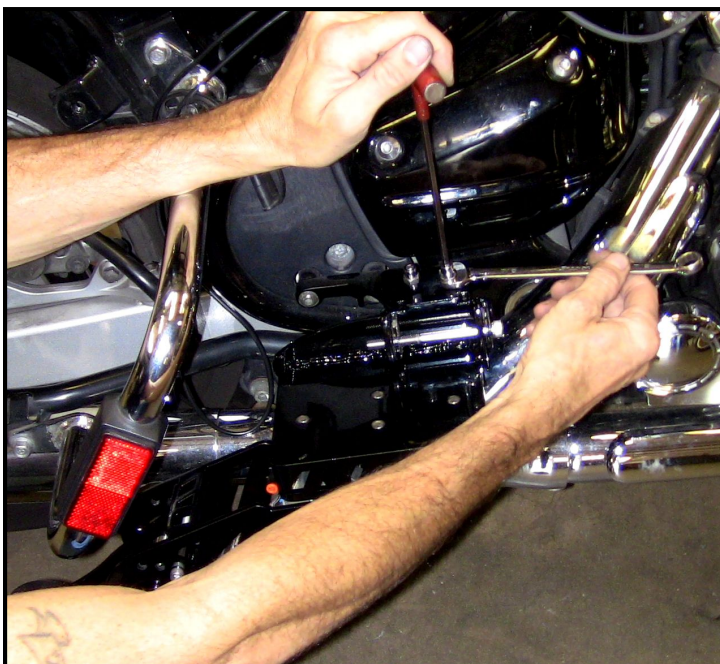
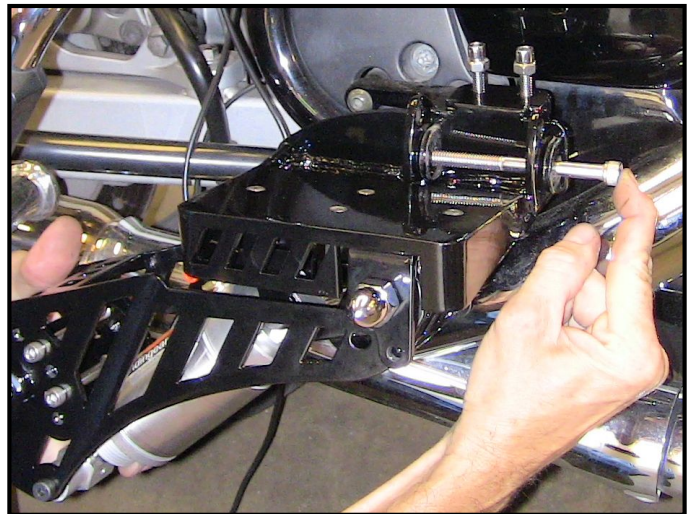

Once the bolt is tight, we want to slowly tighten the 2 Allen bolts on the top of the mount, until they are pressed firmly against the floorboard mounts of the bike. Once these are VERY firm, tighten the lock bolts as shown here. These bolts keep the legs planted firmly to the ground! They should be checked on a regular basis! Grab the leg and give it a shake; it should be very tight to the bike.

Repeat this procedure on the other side. We will mount the floorboards later!

Let's run the air lines!

RUNNING AIR LINES

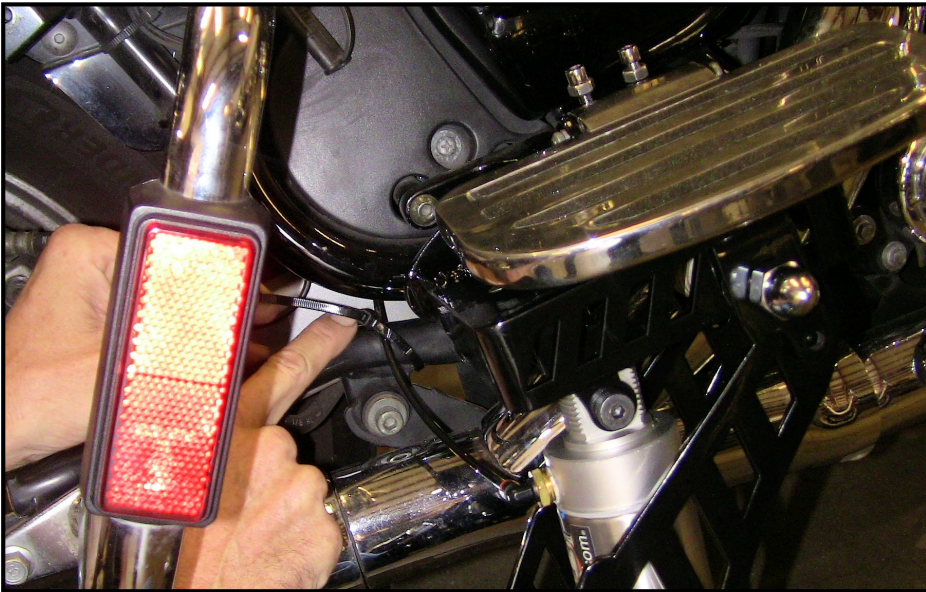

We need to route the air lines from the cylinders to the area near the left saddlebag. You should find 2 long air lines of identical lengths. On the right side of the bike, press one end into the fitting on the back of the air cylinder. These press in relatively easily, but a small tug will make sure the line is seated.

Guide the line down to the saddlebag support bracket you see here. Start a wire tie around the bracket loosely, and slide the hose up toward the battery box (like you did the plug for the proximity sensor). Manually lower the leg so you can see how much slack the line needs, and tighten the wire tie. Lower and raise the leg a number of times to make sure there is no bind and nothing can damage the line.

Once you are sure, run the line behind the battery and out the hole that the harness travels through on the left side of the battery box. Do the same on the left side, and again push the line out the hole toward the left saddlebag.

As you can see here, we then neatly tie the air lines to the main harness running toward the saddlebag.

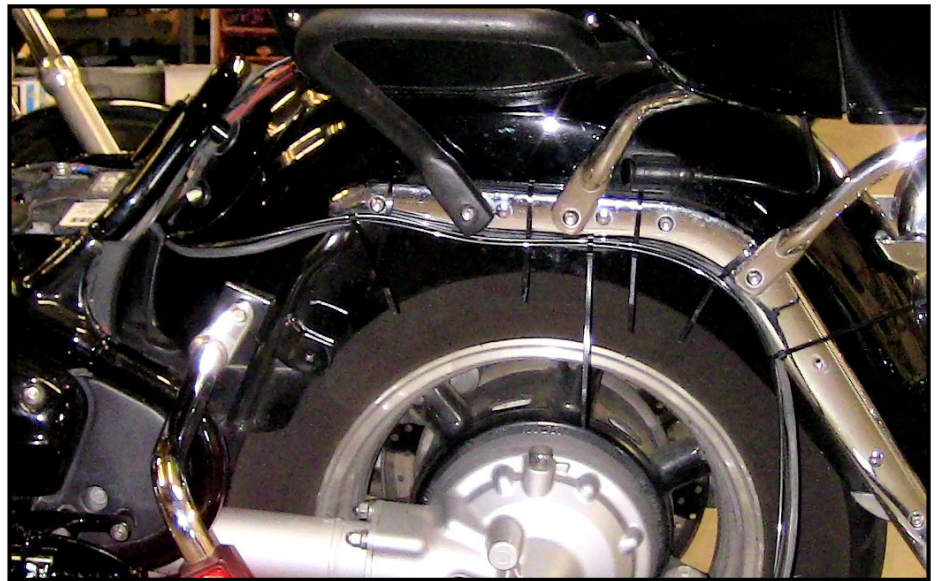

These are air lines, so tie them off snugly. Careful though; too tight could restrict the air flow.

INSTALL THE COMPRESSOR

The first thing we need to do is to reinstall the left saddlebag. Once the bag is installed, make sure the slot you cut is big enough for the wires and air lines to get into the bag with the top closed without damaging anything. If need be, make the slot a bit deeper or wider. If you are happy that everything is safe, we can continue.

Find the compressor, as shown here. We need to remove the top, as it won't be needed until the very end! We do this by removing the three nylon nuts on the top of the plate. These are only hand tight and they will be reinstalled without any tools as well.

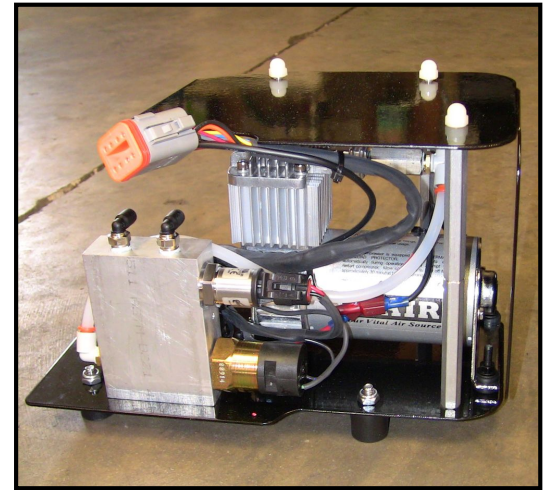

Once the top is off the compressor should look something like the picture below. We want to slowly install the compressor in the bag. The silver valve system goes toward the back, and the compressor is slid back almost as far as it can go. It is mounted on rubber feet to avoid damage to the bag, and to reduce vibration. The picture here shows the compressor plugged in, with lines attached.

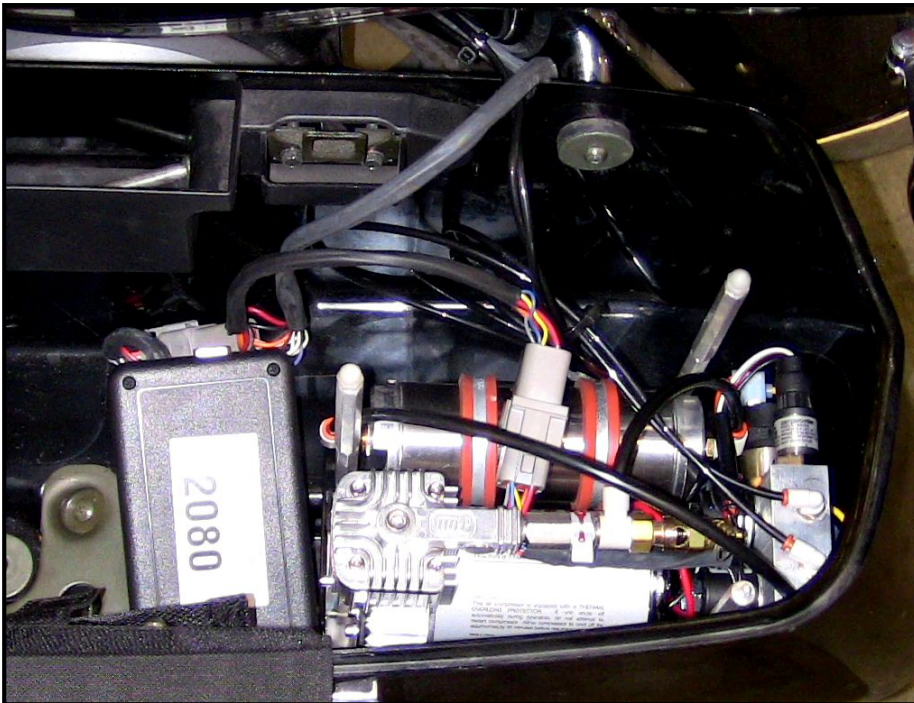

NOTE: We supply you with some black rubber edging. It may be used if after installing the compressor you find the metal edge touches the hard bag somewhere causing a vibration. If once the compressor is on, you need to, cut pieces of the rubber and slide it on the metal where needed to keep the vibration down.

Once the compressor is in place, the air lines should be attached to the fittings on the lines on the compressor system. We took the extra airline, and wound it into a circle and tied it with wire ties. Then we connected the lines to the compressor system.

The compressor should feel very stable in its new home. Assuming it does, this would be a good time to run the big wire into the bag, and connect the computer (seen below with the label on it) to the 12 pin plug, and connect the compressor to the 8 pin plug. We left a loop in the wire and air lines before they entered the bag so water will drop off this bundle rather than be guided into the saddlebag.

These plugs can only be attached one way, and we are going to leave the computer and wires just loose in the bag for now. I promise we will make it all pretty before you are done.

In preparation for testing the system, if you haven't already, hook the negative battery terminal and the lead from our power connection, up to the negative battery terminal (don't worry that the proximity sensor is still lying on the lift!).

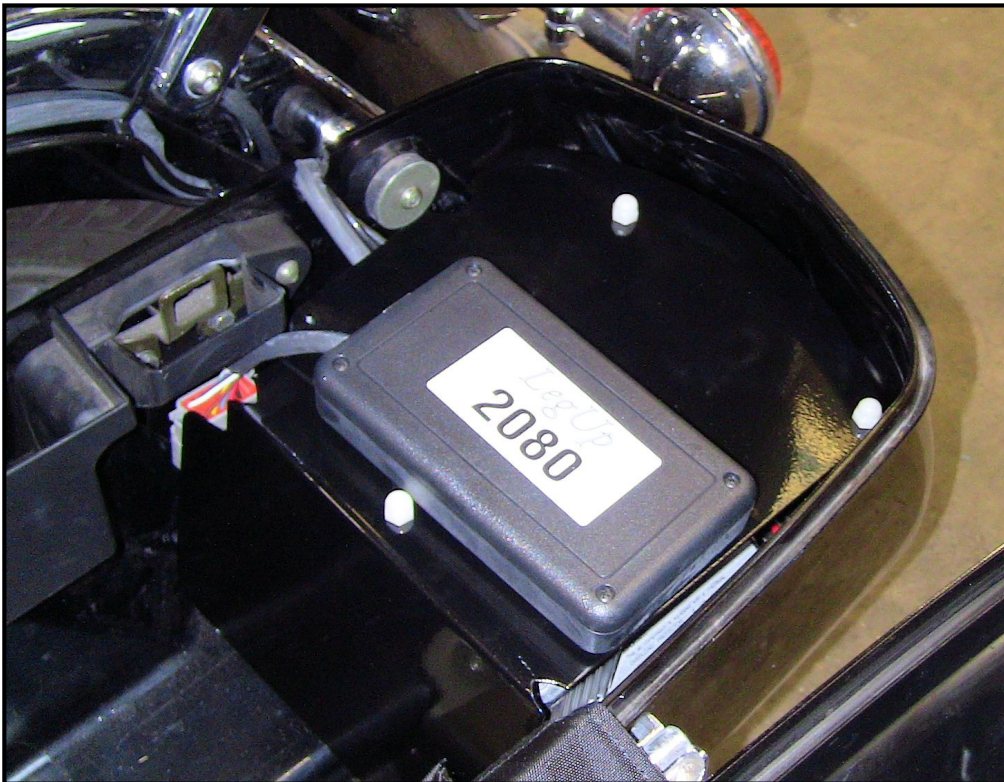

This is just a tease, but this is how the saddlebag will look when you are done!

Now let's test the system.

INITIAL SYSTEM TEST

Turn your bike on. If everything is working properly, the compressor should turn on for about 6 seconds to fill the onboard air tank.

PLEASE NOTE: Immediately after turning on your bike (within 5 seconds), the top light on the handlebar control will flash for a few seconds. This is the system either making sure that no air is in the legs if they are up (for safety it makes sure air does not build up when the legs are in the up position), or that the proper amount of air is in the system if they are down (again for safety to make sure the legs stay pumped completely!). This test occurs once a minute for all the time the bike is powered up, whether you turn the LegUp system on or not!

At this point, have a look at the yellow proximity sensor. The LED Should **Not Be Lit**. Take a metal object (screwdriver, wrench, etc) and hold it on the flat face of the sensor (it has a circle embossed in it). The LED should light up with the metal near, and go out when you move the metal away. If not, check all your connections.

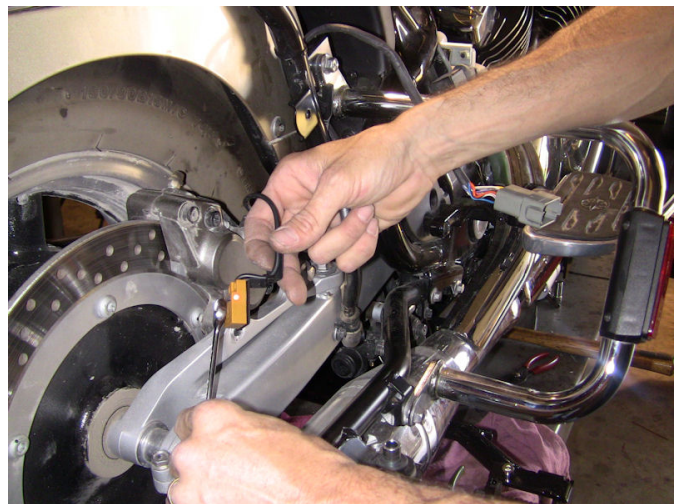

Next, press the rightmost pushbutton on the handlebar switchbox, and hold it for at least 3 seconds. One or both LEDs on the switch panel should light up or blink; we really don't care which at this point. If this occurs, you are doing well. If both LEDs are flashing (maintenance mode) you can skip the next step which is to press both buttons until both LEDs flash.

Next press both buttons again for just an instant! If everything is working, the bottom or yellow LED on the switch box should flash, and the top LED should be out. The next step requires some care. If the bike is still on the lift, have a helper hang on to it as you touch the left button for just a split second. The legs should move down, likely until the wheels hit or miss the lift, and they do this **VERY** quickly! Again be careful as they could lean the bike if one wheel touches the lift and the other does not. Press and hold the right button and they should move up.

Again; with the bike on the lift, ***you have to be very careful here!***

If all of the above has occurred, great! If the legs are not all the way up, press and hold the right button until the legs stop, and turn the ignition switch off!

MOUNT PROXIMITY SENSOR

This step is crucial!! Understand it before starting. The proximity sensor tells the system how fast the bike is traveling. The proximity sensor mounts to the bolt that attaches the rear brake to its mount. Remove this bolt, install it through the bracket and reinstall the bolt semi-tight, so the bracket can be moved if need be (a little Loctite please!). You need to jack up the back wheel or have the bike on the ground so we can spin the wheel to test the sensor and its placement. Make sure the bike is in neutral.

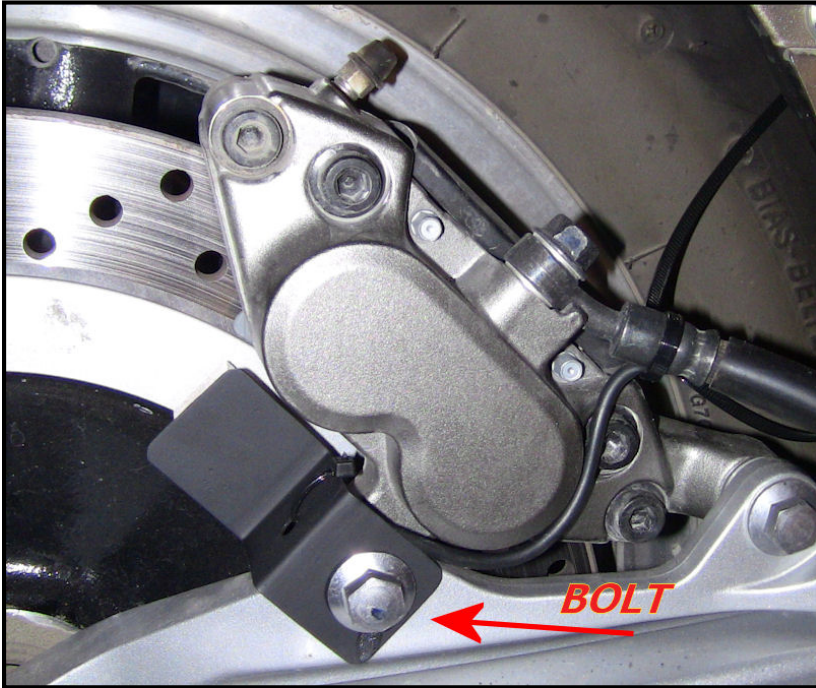

The sensor will track the rotor bolts on the rear wheel as it spins, and is to be mounted 5MM away from the bolts or closer. Look at the picture here. Once the bracket is mounted, turn the key to

the 'ON' position, spin the wheel or roll the bike and watch the behavior of the sensor as the bolts pass it.

The LED on the sensor should be off when no bolt is passing the sensor, and the LED (picture next page) should light when a bolt passes by the sensor. Play with this by rotating the wheel back and forth while adjusting the bracket in, out, left or right until the light blinks consistently.

Once you feel you have the right place, tighten the bracket down and slowly rotate the wheel. Every time a bolt passes, the light should get bright when the bolt is nearby and off after it passes.

If this is not happening, you may need to get the sensor a bit closer to the bolts (5MM is a very small distance!). If you have to move the sensor closer, just loosen the bolt again, and re-adjust the sensor. No matter what you need to do, you **MUST** make sure that as the wheel turns, the light works as described above! Once you are certain, tighten the bracket down very firmly! Re-check that everything functions properly by spinning the wheel past all 6 rotor bolts and verifying that the LED changes as described above. The automatic retraction of the legs as well as their deployment **RELIES** on this sensor being placed perfectly!

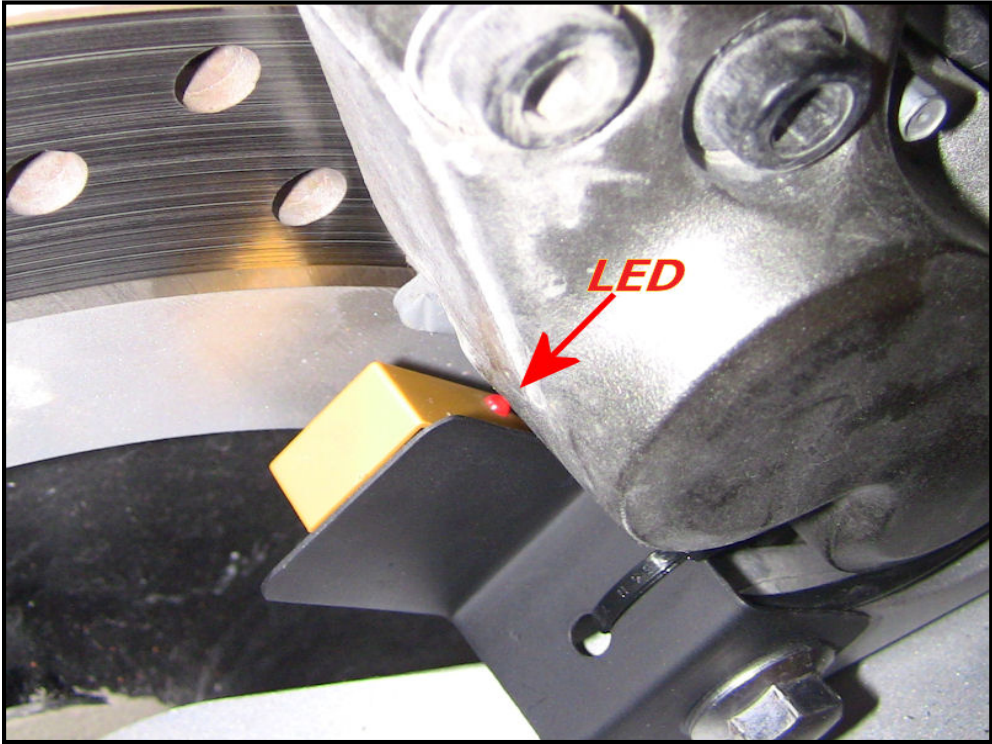

WIRE ROUTING

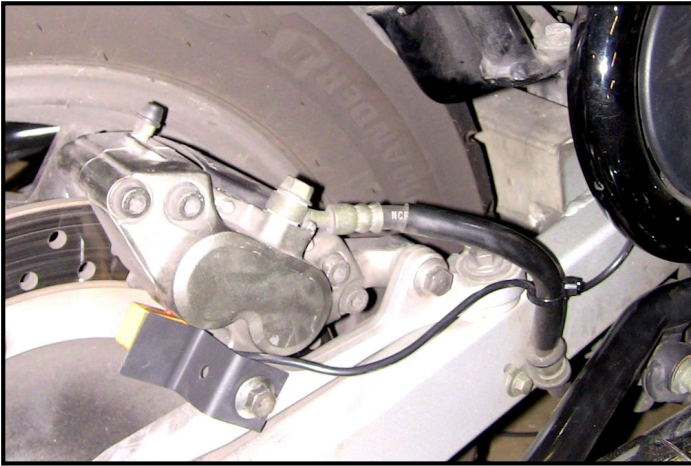

Once satisfied with the mount, make sure that the wire runs down the brake line, and leave some slack as it goes up under the seat. The slack is so the wheel travel doesn't have a negative effect on the wire. Pull all the excess proximity sensor wire under the seat and we will tie it up neatly. Just make sure you route this safely and tie it off securely!

Your wire from the handlebar should already be under the seat, tied off to the handlebar neatly from the switch to the triple tree, and secured safely under the tank. Now is a good time to tie up all the wires under the seat. First make sure you have all excess slack pulled under the seat. We loop our wires, tie the excess as a bundle, make sure they don't interfere with the seat, and tuck them in as shown here.

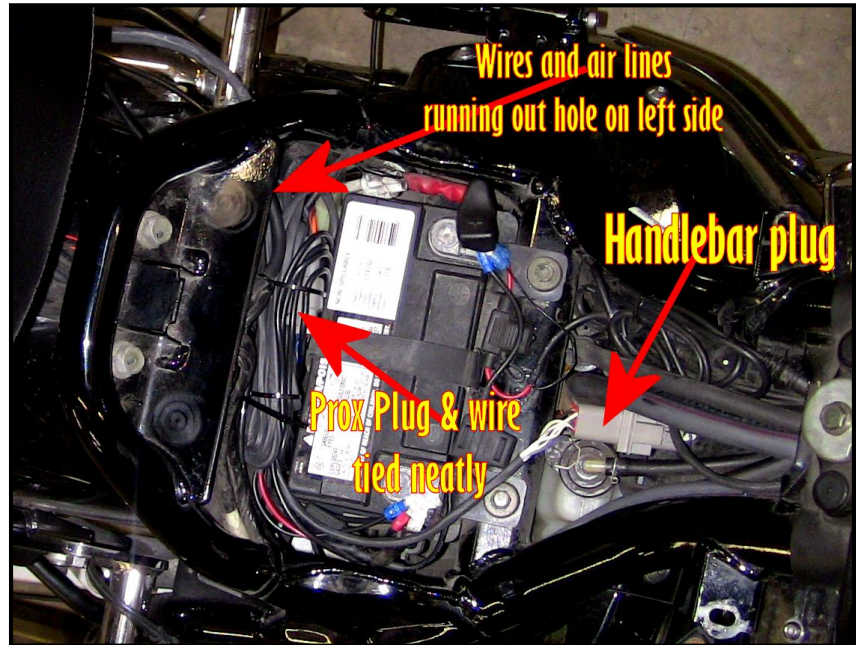

Next, we need to make sure the compressor plug is attached and tucked in as we install the top. Find the L-shaped metal top that you removed from the compressor earlier. The top mounts with the two holes toward the back of the bag, with the single hole toward the front. It is a tight fit, so slanting it into the bag is best.

As you work the top over the 3 aluminum standoffs, make sure the computer and plug (sometimes it is easier to unplug the computer until the top is set) are coming through the curved cutout, as the plug and computer will sit on top of the compressor system. Once the top is fitted, find the 3 nylon nuts and screw them on the three posts to secure the cover. These are plastic nuts so no wrench is required here.

When complete, you want to Velcro the computer onto the top and make sure the plug (*the compressor plug stays UNDER the top*) and wires look something like this. Our main concern here is to give you as much of the saddlebag as possible, and make sure the wires and components are not going to be chaffed or damaged.

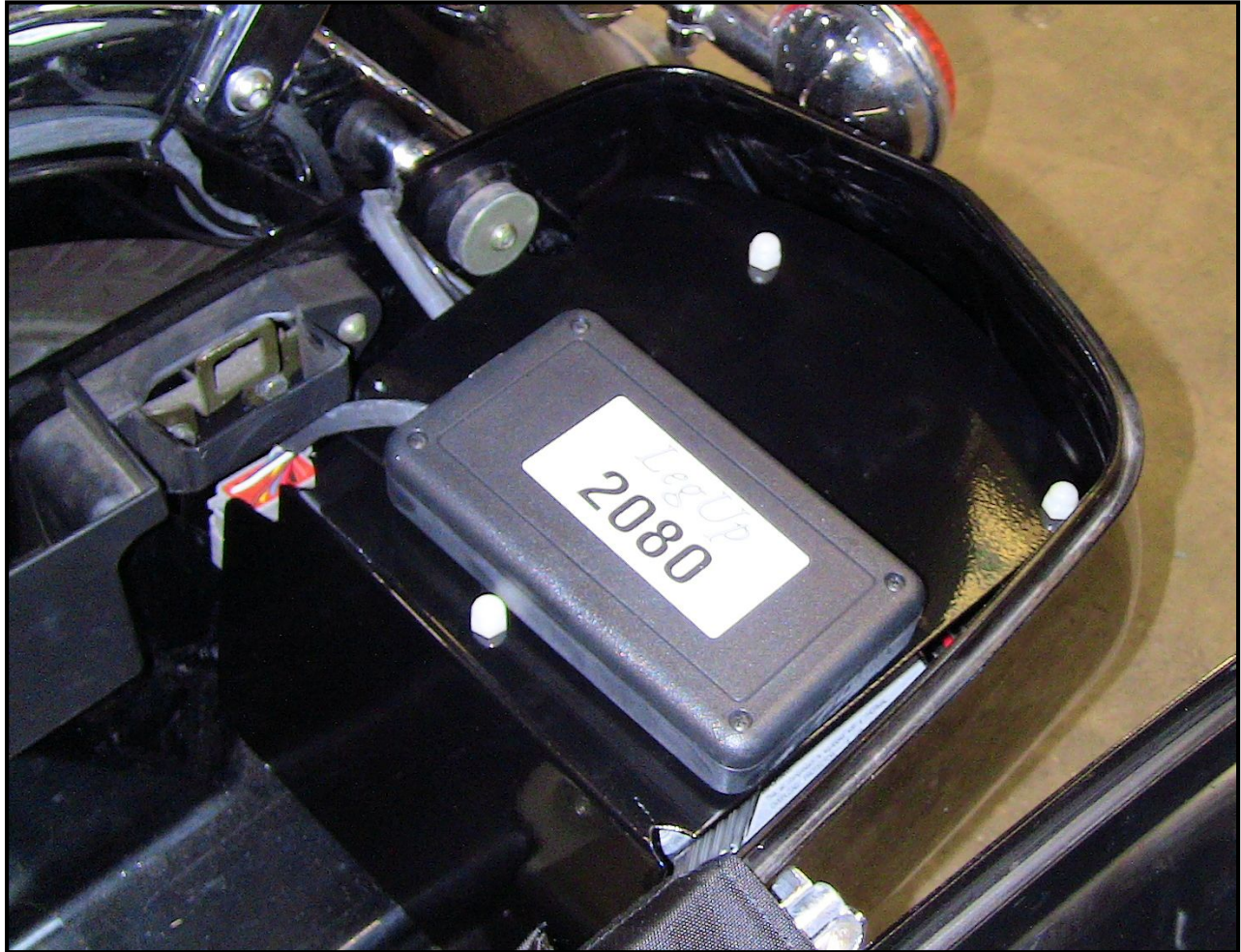

FINISHING UP

Now it is time to reinstall everything you took off, and do final checking of everything! Reinstall the seat making sure all your wires are routed neatly, tied off nicely and don't interfere with the seat installation. We left the right saddlebag off until we test drove the bike. Once you are sure the speed sensor is functioning properly, you can install that bag.

We need to install the floorboards. Find the supplied 3/8" X 3" Allen bolts and lock nuts, and install a floorboard to the empty holes on the top of the leg mounts.

NOTE: These boards will NOT be able to be flipped up any longer! We decided that since the wheels would be in the way even if the boards could be flipped up, we would not raise the floorboards another inch just to allow them to pivot on these pins!

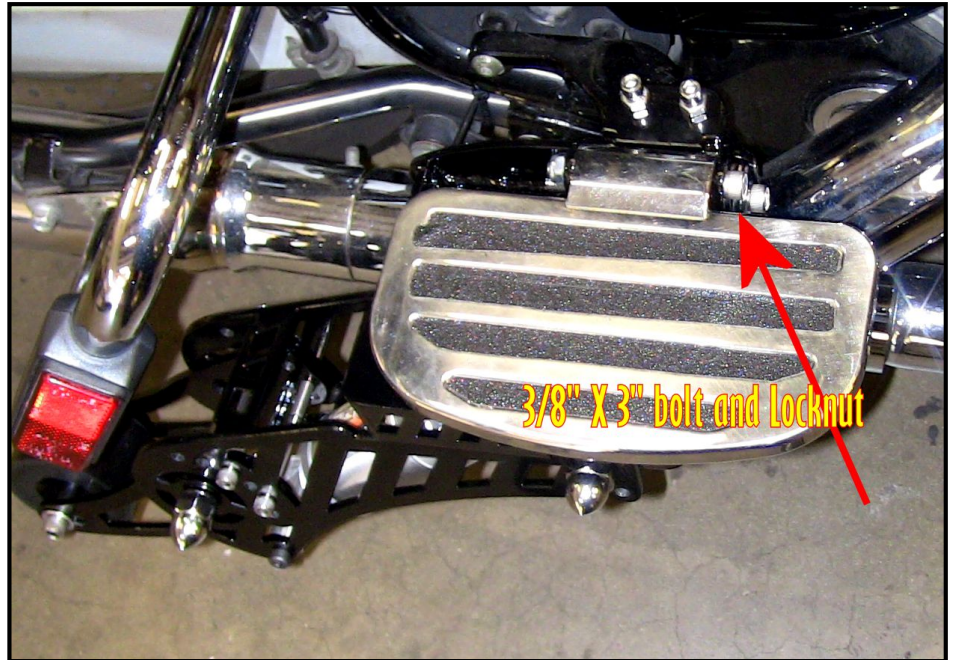

Once this is accomplished, we should get the bike on the ground, and with a helper, cycle the wheels up and down a few times, having your helper make sure the air lines are not being scuffed or are over tight, and that the wires are out of the way of anything that could damage them.

Double-check all your bolts for tightness. Now we can dial in the legs, and adjust the wheels if needed.

LEAKS!

This system uses air, and air loves to leak! The fittings we use are tested for leaks before shipping, but we have a few simple tests to make sure you have no leaks or just insignificant ones if any.

Set the wheels down and leave the system on. Put the kickstand down, and turn the bars all the way left.

If the compressor makes noise more than once every two minutes, you may have a leak at the lines that connect to the compressor or the tank fittings. Some soapy water will tell you where (you will need to remove the compressor top to test for these leaks).

Assuming the compressor doesn't lose enough air to kick on after 2 minutes, you should be fine.

You can turn the bike off, and wait to see if in 5 minutes the bike is not as stable as it was when the wheels were first lowered. If it lasts the 5 minutes and is still very stable, you could still have a leak, but not one that would be a problem on the road!

REMEMBER: Royalstars will NOT sit on both wheels without a rider in the saddle. You can still test that the wheels are firm without a rider; just understand that only one wheel at a time will be in contact with the ground. Sit on the bike, and both wheels will touch!

Leave the bike on its wheels overnight (again kickstand down, bars full left in case the legs lose a lot of air; the bike will land on its stand). If in the morning, the bike is still stable you have no leaks.

If there are leaks, the fittings on the air cylinders would be the first for the soapy water check, with the two small line fittings on the compressor next! If you need help with these, please feel free to call us at (407) 834-5007.

FINAL ADJUSTMENTS & MAINTENANCE MODE

The next two sections are typically **NOT** needed. We include them to document your system thoroughly, but **MOST** people will never need to use either section.

MAINTENANCE MODE

NOTE: Maintenance mode is a procedure that 'TEACHES' the computer how much pressure to use when it lowers the wheels and how much pressure to release when raising the wheels. We always set this at the factory; ALWAYS!! We include this procedure in case it is ever needed in the future. Please skip this section unless you have been instructed to reset the system by Chopper Design.

Turn the ignition to Accessory and start the LegUp System (hold right button for 3 seconds). The system should be set at the factory for proper pressure, but some wheel adjustment may be needed. If it has been determined that '**Maintenance Mode**' is needed, Sit on the bike, and hold it level. If both lights on the switch box are flashing, the system is in maintenance mode. If not,

PRESS & HOLD both buttons until all lights flash. *(Do your best to press both buttons at the same time so the system doesn't respond to what it thinks is a request to lower the legs)* Once flashing, hit both buttons for an instant to get the system in the 'DOWN' setting mode (lower, yellow LED flashing). Touch the left button briefly; the wheels should go down immediately. *(This is VERY quick, don't be startled!)* Using very short pushes of the left button, press and then feel the stability of the bike. If it feels firm enough, try leaning the bike a bit. If the wheels return the bike to upright, there is likely enough pressure. Put your feet on the floorboards; the bike should stand on its' own. Rock the bike a bit left and right, being prepared to put your feet down. If the bike continues to come back to upright, the **DOWN** stop is now set and we can move on.

Hit both buttons for a moment to get into the 'UP' stop mode (Usually hitting the left button just before the right assures that air is not released!) The top LED should now be blinking. Press and hold the right button to raise the legs. Listen as the air evacuates; once it is quiet, let go of the right button. The **UP** stop is now set! Hit both buttons when complete, Both LEDs should light, and you are done with these adjustment.

Now press the left button and the legs should lower; again this is fast and loud. The bike should be held up firmly! Hit it again and the legs should retract. If you are satisfied with these limits, you have successfully installed the LegUp System.

WHEEL ADJUSTMENT

*The LegUp GEN II system is typically set up at the factory for the height of your bike. The system is **VERY** height dependent! If after testing the initial installation, the bike does **NOT** feel stable, the wheel system **MAY** need to be adjusted to the height of your bike. **Remember**; the Royalstar has a suspension that rises substantially without any weight on the seat, so the stability needs to be checked with a rider on board. **DO NOT** make any changes unless the stability we expect is **NOT** present! If you feel you need to adjust the height/length of the wheel holders, please read this **ENTIRE** section before starting the process. If you need help, please contact Copper Design at 407-834-5007.*

If you are happy with how stable the bike feels, you can skip this section, and move on to a test ride! If you are not sure, or you skipped 'maintenance mode' as instructed, a good test is to bring the wheels down, put the kickstand down, and lean (or try to) the bike on its kickstand while sitting on the bike. If the bike comes back to center without your help, or you put your feet on the boards and can bring the bike up by just

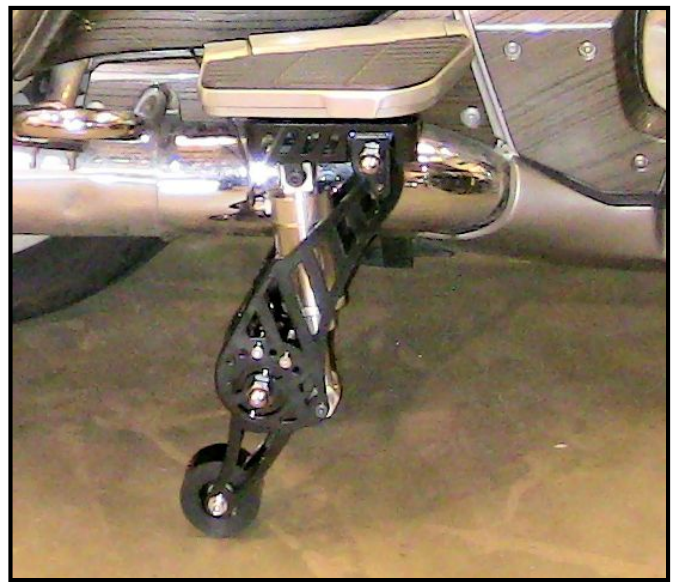

leaning to the right; move on to the next section (Test Ride), the wheel settings are fine!

The stability of the GEN II LegUp system, relies on the pneumatic actuator, when deployed, being at an angle that is forward of perpendicular for best results! Different bikes are at different heights, and Chopper Design uses an ingenious method to adjust the length of the supporting legs to maximize the stability it affords.

Typically, we will send the 'Leg Assemblies' set up for perfectly for your bike. In the event your bike is at a different height than stock, the information and adjustments that follow may be required.

Below, we show you the wheel holders which should help clear up any confusion you may have about the wheel holders and their adjustments.

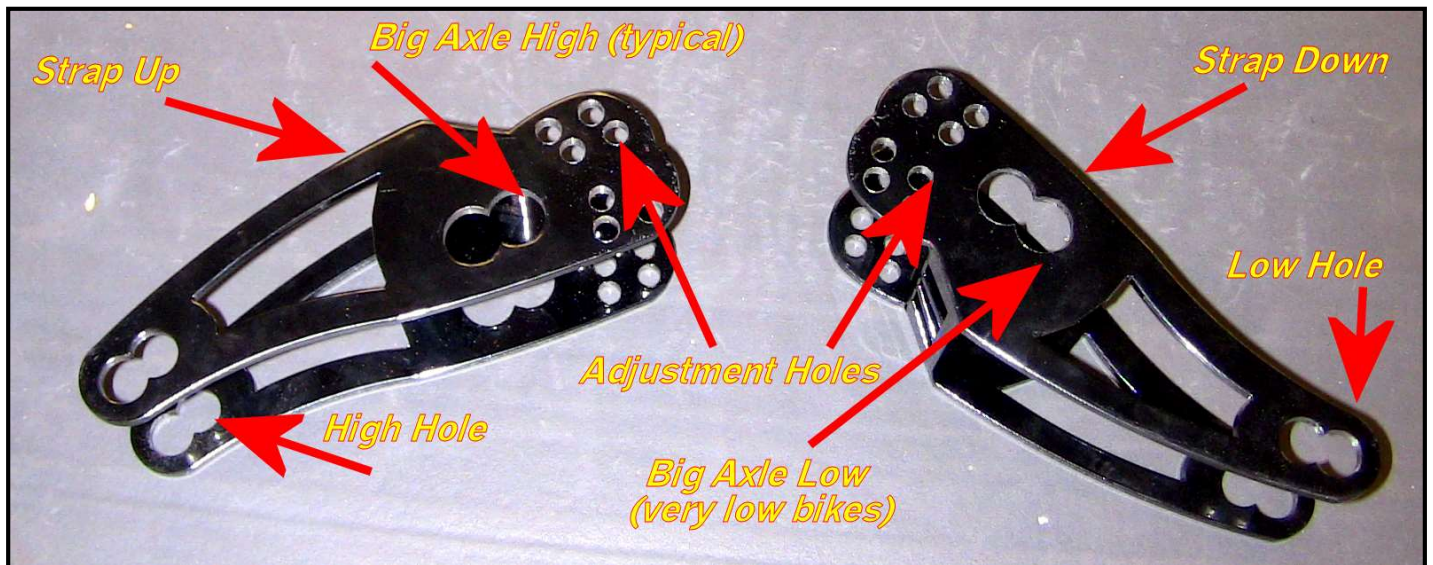

On each supporting leg, you will find two bolts down near the end by the wheels. The two bolts control the angle of the 'Wheel Holders'. By moving the wheel forward or back, we can tailor the length of the support arms to a particular bike.

A helper is handy here. Make sure the wheels are up. Make note of exactly which two holes the bolts are in. Loosen the locking nuts from the back and remove the bolts; you will notice the 'Wheel Holder' can pivot on the big axle bolt. Starting on

the left side of the bike, move the bolts one hole counter-clockwise. Go to the right side and move them one hole clockwise. Loosely fit the nuts (no need to final tighten them at this point).

Lower the legs. Is the bike more or less stable? If it is more stable, and you can sit on the bike and rock it back and forth without it leaning over you are done. If not, remove the bolts again, and move them in the opposite direction two holes, and retest. If everything is fine, final tighten the lock nuts and you are done.

If you need to, you can move the wheels from the lowest hole, up one hole. You can remove the wheel holders, turn them over (strap up instead of down for example) and install them on the other side of the bike. You can move the big axle from the low to the high hole. All these techniques take patience, but allow significant flexibility to tailor the system to your bike. On the next page we show you some examples. Normally you do not need to do **ANY** of these adjustments, but if you need to, we wanted to teach you the methods at your disposal.

TEST RIDE

PLEASE NOTE: Immediately after turning on your bike (within 5 seconds), the top light on the handlebar control will flash for a few seconds. This is the system either making sure that no air is in the legs if they are up (for safety it makes sure air does not build up when the legs are in the up position), or that the proper amount of air is in the system if they are down (again for safety to make sure the legs stay pumped completely!). This test occurs once a minute for all the time the bike is powered up, whether you turn the LegUp system on or not!

Get the bike to a clear paved mostly level area where you can test ride it. Start the bike, turn on the LegUp system and lower the legs. The first test should be done in a straight line. Put the bike in gear and slowly accelerate. You may notice that the bike tends to want to steer a small amount left or right. This is normal unless it is severe. Effectively, you are driving a trike, and steering is done with the handlebars **NOT** by leaning. Once underway, (we recommend you keep your thumb near the left button, and press it to raise the wheels if there are any surprises) the top LED should flash at around 6 MPH, meaning the legs are retracting. It is difficult to lean on one wheel or the other as you leave, so you may wish to raise the wheels manually if the bike is steering due to uneven pavement.

Assuming the legs are retracted, you should try to deploy the wheels. As you come to a stop, the Green LED should be on. As you slow down (**almost stopped**), the Yellow LED should illuminate at the proper speed. Once it does (sometimes hard to see), hit the left button and put your feet down near the ground. The top LED should flash and the wheels should deploy almost instantly underneath you! Make sure you are ready to balance the bike, though you likely won't have to! Immediately after the wheels touch the ground, the bike should be supported reasonably, but the cylinders can take up to 6 seconds to get completely filled. Make sure you balance the bike as this occurs. The slower you are going when deploying the wheels, the smoother the transition will be from wheels up to wheels down. Practice these maneuvers until you are comfortable with the wheel adjustments and the system operation.

NOTE: With the system on or off, if the legs are up, the computer will dump the air from legs once every minute that the bike is turned on! This is a safety feature to make sure pressure does not build inside the legs, causing them to deploy! The top light will flash once a minute for a few seconds. This is completely normal, and the left button will be inoperable while this occurs.

SEMI-AUTOMATIC DEPLOYMENT: Another way to deploy the legs is semi-automatically. First we must be **SURE** that the proximity sensor is working properly or the wheels could come down at higher speeds than we wish. If you are travelling at a speed over 10 MPH, AND the yellow light (bottom) on the handlebar control is out, hit the left button. The bottom or yellow LED should start to flash. When you slow down to around 5MPH the wheels will deploy (see the red/green flash on top LED). Again prepare to put your feet down. IF the lower LED is lit at a speed over 10 MPH, don't hit that button; see caution below!

NOTE: The bottom LED Should not be LIT SOLID if the bike is travelling over 10MPH! In the event it is, the wheels will deploy instantly if you try to set them as above; this is dangerous! You MUST re-visit the sections on testing the proximity sensor. You should always be aware that this light should NOT be on if you are traveling at speed, and 'Arming' the system for deployment should only be attempted if the lower LED is Not Lit! Please see the User Manual for more information on Proximity Sensor Failure!

The next thing to try is to make a turn from a dead stop with the wheels down. As soon as you start the bike moving, turns can only be made by using the handlebars. The LegUp system is too strong to allow a great deal of lean with the wheels down! If you need to make a turn shortly after departing from a stop, raise the wheels manually (left button) and you will get complete control again.

The next thing to try is slow speed maneuvering with the wheels lowered. If you keep your speed down, most slow speed maneuvers can be accomplished with your feet up, keeping in mind that at about 6 MPH the wheels will come up automatically! You can try full lock turns in both directions and the bike should stay upright with your feet up.

Understand; it is always a good idea to keep your feet near the ground during these maneuvers if you can. A mechanical failure or a wheel in a pothole could upset the bike.

Because the wheels are right behind your legs when they are down, we recommend not trying to push with your feet to move the bike forward. Use the engine and keep your feet out of the way; this way the legs don't bite at your heels as the floorboard always have! Backing up using your feet works fine and the chore of balancing the bike is taken care of for you.

Practice, practice, practice!! Enjoy your LegUp System!

ILLUSTRATIONS

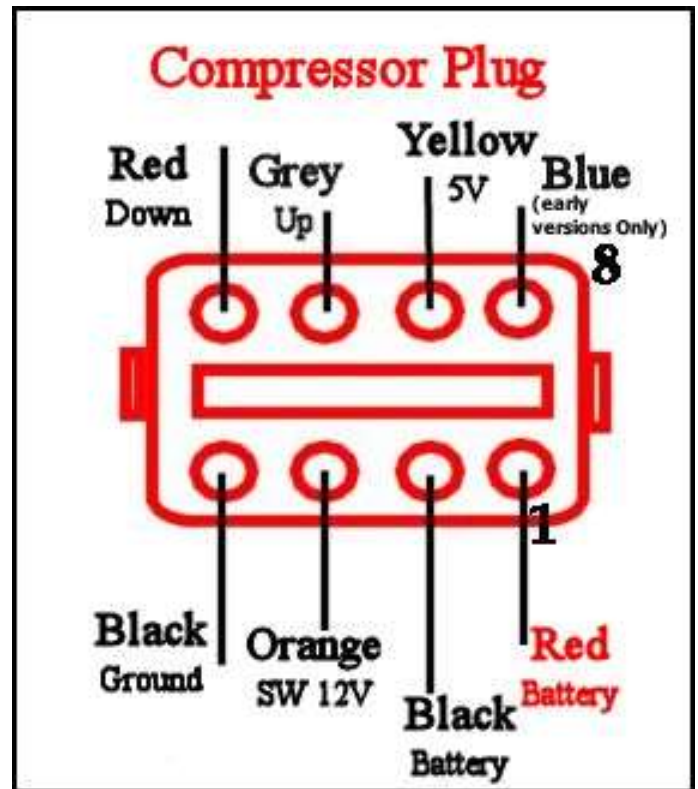
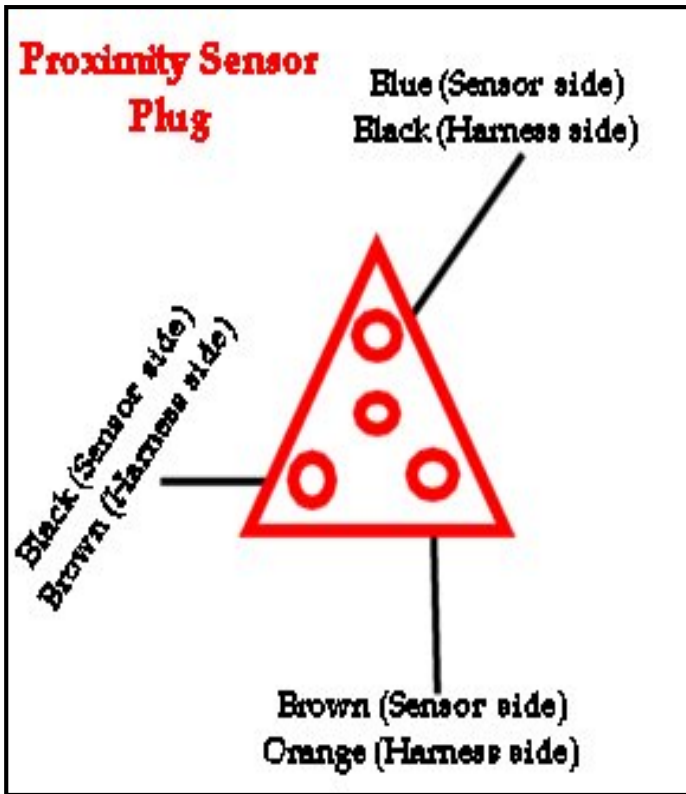

Due to global distributions problems, we may have to use a four pin plug instead of a 3 pin plug. The colors still need to be the same across the plugs with pin 4 empty!

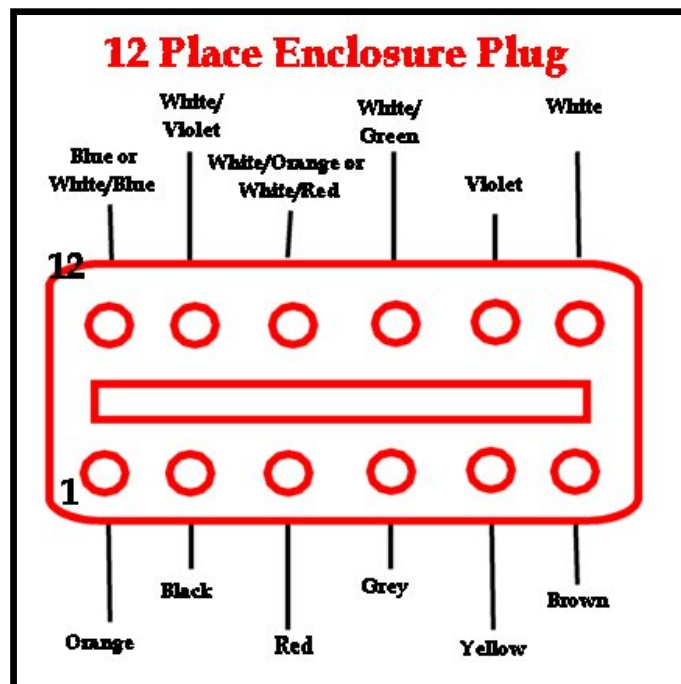

HARDWARE LIST

- (2) 5/16-18 X 3.25" Allen Bolts with Lock Nuts**
- (2) 5/16-18 X 3.00" Allen Bolts with Lock Nuts**
- (4) 1/4-20 X 1.125" Allen Bolts with Jam Nuts**
- (2) Fold-over Spade tap connectors**
- (4) Rubber Spacers, for tops of mounts, quiet floorboards**

- (1) 10-32 X 1 1/4" Stainless Allen with Spacer (7/8"X3/8", Mount for Handlebar Switch)**
- (2) 5/32" Black Air Line, 5 Foot long**
- (2) 5/32" Black Air Line, 2 Foot Long (Valve to Unions)**
- (2) Air Line Unions**

Hardware Bag with ties, Rubber bumpers installed on plate, etc.