



Installation Manual Generation II - Kawasaki 1700

**Copyright 2015, Pete Giarrusso, Inc.
D/B/A Chopper Design Services
All Rights Reserved**

Table of Contents

INTRODUCTION	4
WARRANTY	5
INSTALLATION INSTRUCTIONS	6
1) <i>Wire Harness W Switch Box</i>	6
2) <i>Leg and Mount Assembly (L/R)</i>	6
3) <i>On-board Computer Module</i>	6
4) <i>Proximity Sensor</i>	6
5) <i>Saddlebag Mounted Compressor System with Tank</i>	6
6) <i>Hardware Bag</i>	6
PREPARE FOR INSTALLATION	7
CONTROL SWITCH BOX.....	8
WIRING HARNESS	9
LEG & MOUNT ASSEMBLIES	12
RUNNING AIR LINES	14
SADDLEBAG PREP	15
INSTALL THE COMPRESSOR	16
MOUNT PROXIMITY SWITCH.....	18
WIRE ROUTING	20
FINISHING UP	20
<i>FINAL ADJUSTMENTS & MAINTENANCE MODE</i>	22
<i>MAINTENANCE MODE</i>	22
<i>WHEEL ADJUSTMENT</i>	23
ILLUSTRATIONS	27
PARTS LIST	28

Introduction

This manual covers installation of the Generation II LegUp LandinGear system by Chopper Design Services. This system should only be installed by a qualified technician, or those with above average mechanical skills. If you are not **SURE** that you can perform this installation, please contact us and we will help you find a qualified shop to assist you.

While the Generation II System holds your bike upright very well, you are **STILL** responsible for balancing the bike! The system **WILL** relieve you of some of the weight of the bike and help you avoid balance problems as you approach a stop, maneuver at slow speeds, and back the bike up.

Improper installation will void your warranty, so please be very careful!

Thanks for choosing LegUp!

Warranty

Chopper Design Services warrants the LegUp system for a period of one year from date of purchase. This warranty covers replacement parts and/or manufacturer defects. Incidental damages or costs are the responsibility of the purchaser.

Defective parts are to be returned to Chopper Design at the address below. Purchaser must contact Chopper Design to receive a Return Material Authorization, prior to returning defective parts to Chopper Design.

Abuse, improper installation or use, collisions or accidents, are not covered under this warranty. Replacement parts for this type of damage are available through Chopper Design.

Users of the LegUp system agree that Chopper Design is NOT responsible for personal injuries or damage to property arising from the use of the system. While we believe this system to be safe and reliable, the user is advised that use of LegUp is done so at the users' own risk. Use of the system implies agreement to the above statements. If you can't agree with the above, Chopper Design and its dealers would be happy to refund your full purchase price, before you use the LegUp System.

Chopper Design Services
1365 Bennett Dr #101
Longwood, FL 32750

407-834-5007
LegUp@LandinGear.com

Installation Instructions

The LegUp® system has many components. Please be sure you have them all before starting your installation.

COMPONENTS:

- 1) **Wire Harness W Switch Box**
- 2) **Leg and Mount Assembly (L/R)**
- 3) **On-board Computer Module**
- 4) **Proximity Sensor**
- 5) **Saddlebag Mounted Compressor System with Tank**
- 6) **Hardware Bag**

If you believe you are missing any parts, please contact Chopper Design at 407-834-5007, and we will rectify the situation. Some of the parts are shown below.

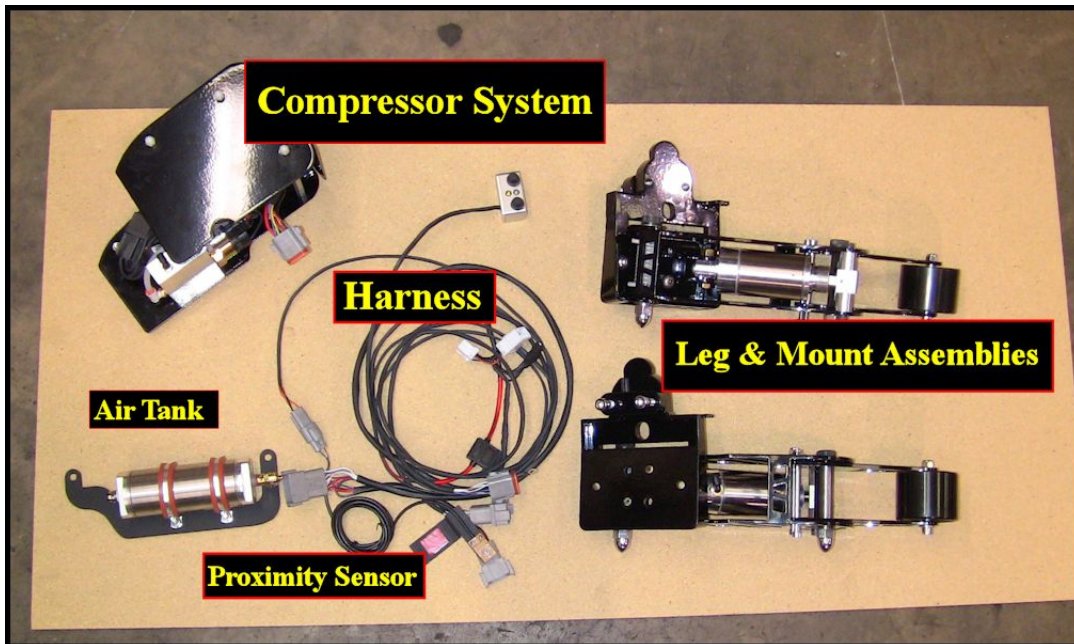

PREPARE FOR INSTALLATION

Place the motorcycle on an acceptable bike lift. You will need to keep the bike on its wheels for most of the installation, and jack the rear wheel off the lift for some portion of the installation. Make SURE the motorcycle is secure on the lift!

Remove the seats and both passenger floorboards; they are not needed until the very end of the installation.

This manual is available at <http://landinggear.com/pdf/g2installkaw1700.pdf> . It may be easier to see some of the pictures in color there!

We are now ready to begin!

CONTROL SWITCH BOX

Disassemble the 8-pin connector attached to the switch housing. The switch wires will run down the handlebar and ultimately under the tank to the area under the seat.

You will need to remove the two Phillips head screws that hold the chrome plate to the left of the master cylinder. The plate is then pried off the mount.

The switch box is installed using the same two screws in the same holes. Mount this plate, and then we can run the wires.

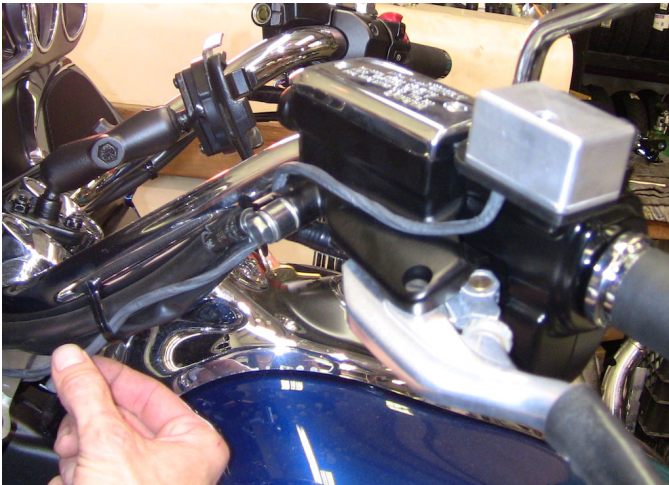

Run the wires down the back of the handlebar along with the other wires, in front of the triple tree, then under the tank.

We tape the wires together to make this easier. As you can see below, the wire will appear in the area under the seat. Use the Diagrams on the next page to insert the wires in the 6 or 8 pin plug provided.

More installers make a mistake with this plug, than anything else in the entire installation, so take your time here!

The wires **MUST** be reinstalled correctly or damage to the computer may occur.

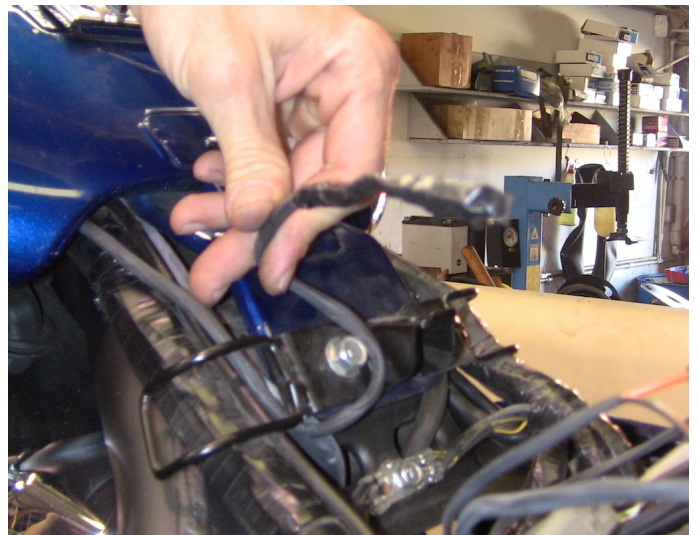

Pin Out for Handlebar Control Box Plugs

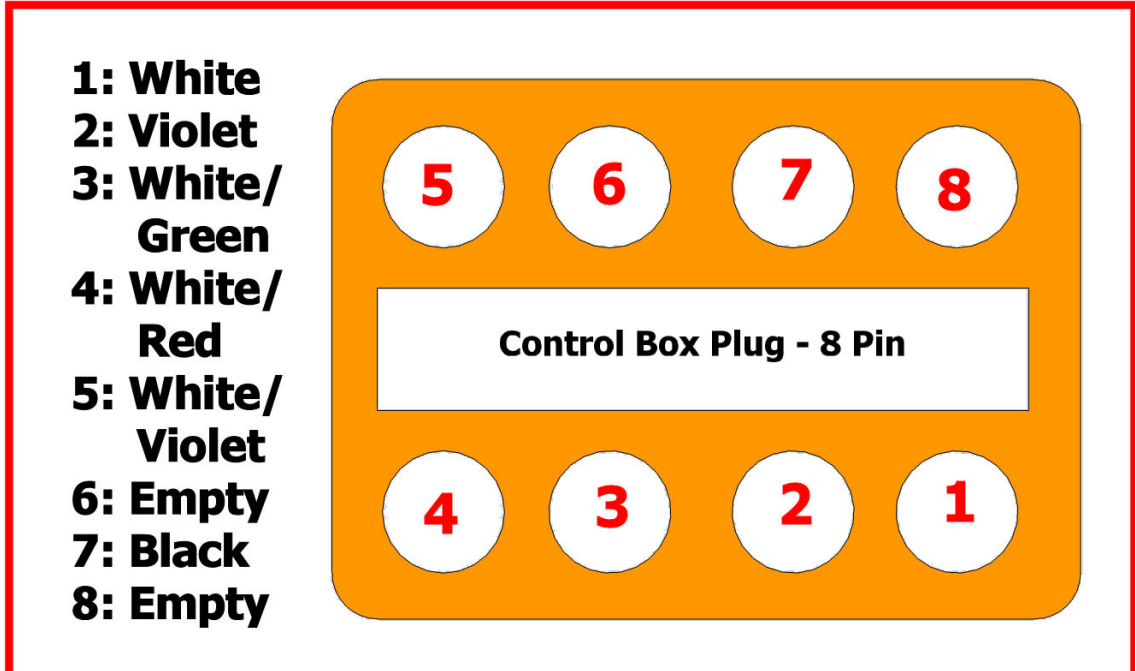
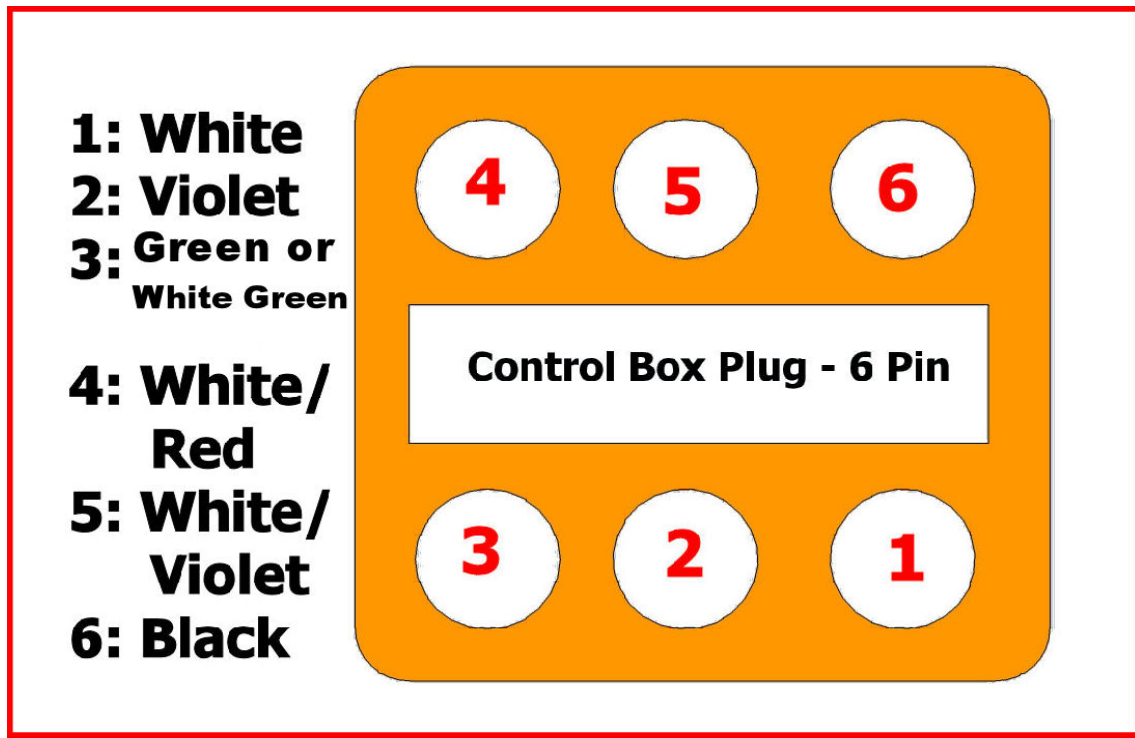

WIRING HARNESS

The next step is to route the wiring harness. You can take most of the wiring harness and drop it where the seat would go. We already ran the wires from the handlebar switch, so that plug should be under the seat. We need to get the proximity sensor wire (3 pin), under the seat as well.

Find the two BIG plugs on the harness (12 pin with an 8 pin pigtail attached), and slide them through the seat area, and out just below the left fender support. Leave the remainder of the wire harness under the seat for now. Once both plugs are through, you can pull most of the slack out. We will be pulling these plugs back toward the back end of the saddlebag, to get to the compressor system.

The Proximity plug needs to get to the same spot. The bracket for the Proximity Sensor (yellow rectangle with an LED) mounts to the lower left shock bolt (not yet!) so the wire will be tied to the swing arm and up through the side cover area as well.

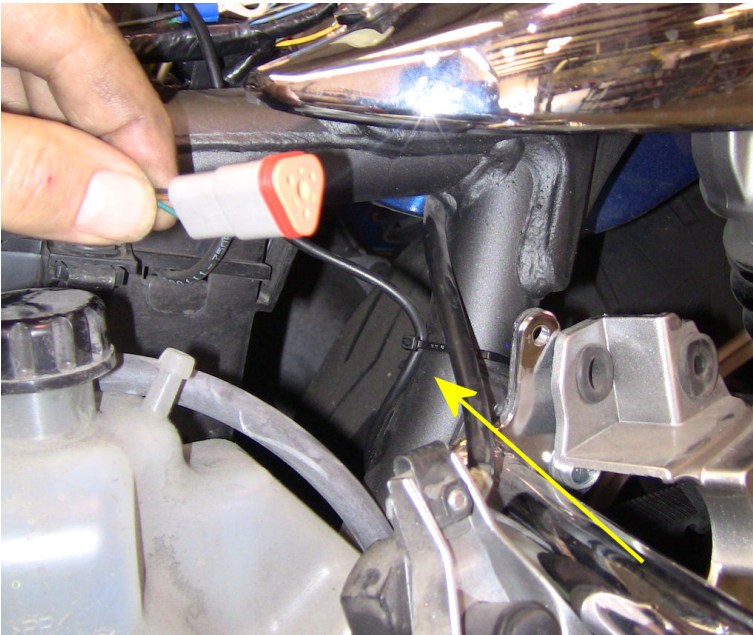

Here we show the plug under the seat and have a temporary wire tie on the frame so the wire can run down to the left back axle area for mounting later!

Now we have to get power for the system!

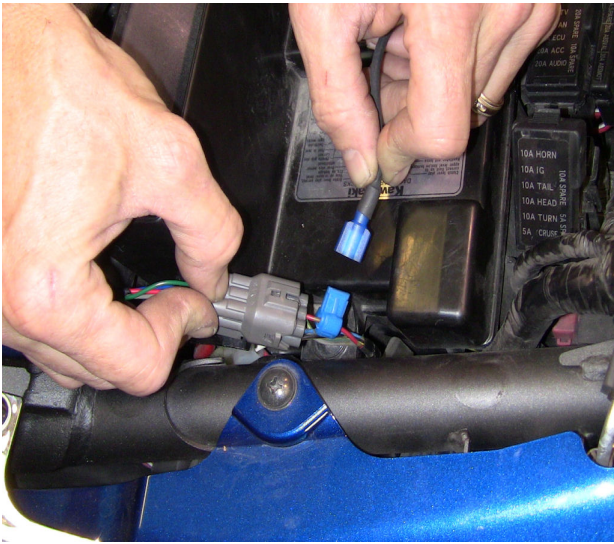

Find the orange wire with the blue plug and the black wire with the hoop connector (On later harnesses, the Black wire is eliminated). The system draws very little amperage; we decided to use the running light circuit, which is a red wire with gray traces on the grey plug you see here. We don't care where you get your 12 Volt source as long as it is switched and stays on while the bike is running.

Find this wire (we had to strip back some tape) and attach the blue locking connector to it. The blue spade from the wire harness will mate to this plug as shown above.

We next need to ground the system. Find the hoop connector on the black wire (IF PRESENT) and run it toward the front of the under seat area. You will find a number of grounds under a bolt there. Remove the bolt, place the hoop on the bolt and re-insert the bolt into the threaded hole.

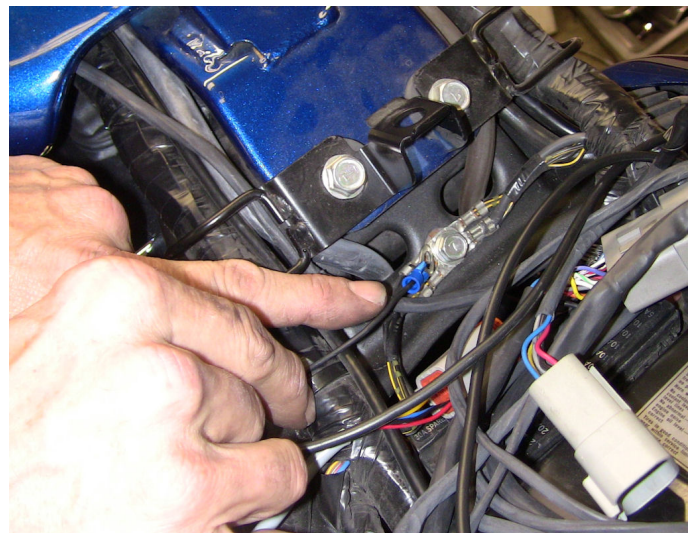

We also have 2 wires in the harness (Red & Black with hoop Connectors) that need to be attached to the battery to run the compressor. The red wire has a fuse holder on it. We recommend removing the fuse. Find your battery (remove all the covers) and attach the red to the positive and the black to the negative battery posts. Make sure the fuse holder is accessible, and put the battery cover back on.

Now run the wire with the 2 big plugs on it, down the left fender support toward the back of the bike. Next, measure 10 inches back from the 12 pin (biggest) plug and mark the wire. We are trying to make sure we have all the wire we need but not too much extra. We chose to tie this wire loosely under the fender brace for now. We will be adding the airlines and getting all of these in the saddlebag later, as well as pulling the extra slack back under the seat.



Let's mount the legs!

LEG & MOUNT ASSEMBLIES

Now we need to mount the Legs to the where the rear floorboards were mounted. Before we start, we assume the boards have been removed, remove the rubber piece inside the yoke of the floorboard mounts. There are two plugs and a rubber strip between them. This is difficult, but

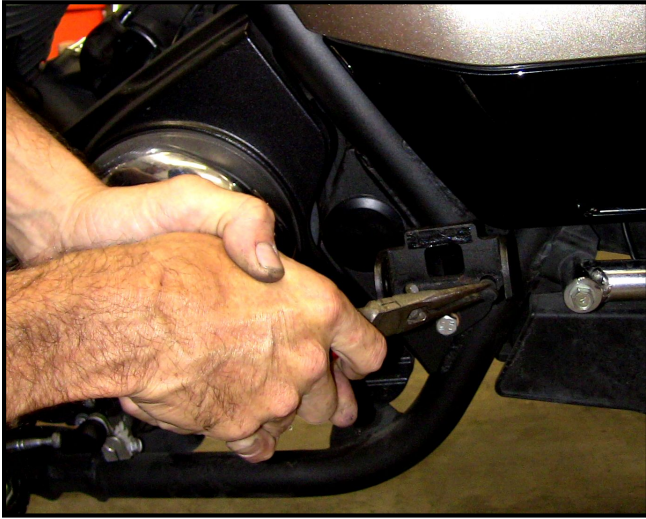

we don't need the rubber when we are done, so don't worry if they get damaged during removal. We want to expose the two holes the rubber is filling, to be used to mount the Leg Assemblies.

Once the holes are exposed, take the leg assembly for the side you are working on, and using a 5/6" X 3 1/2" Allen bolt, put it through the lower mount hole on the Leg Assembly, and through floorboard mount. Find a locknut and just start it on the bolt. The bolt gets mounted Allen head toward the front.

This takes the weight of the leg and gives it to the bike!

Next we want to find (2) 5/16" X 7/8" Button-head bolts, and put them through the holes just below the bolt you just installed; the ones the rubber plugs came out of. You may have to wiggle the assemblies up and down a bit to get

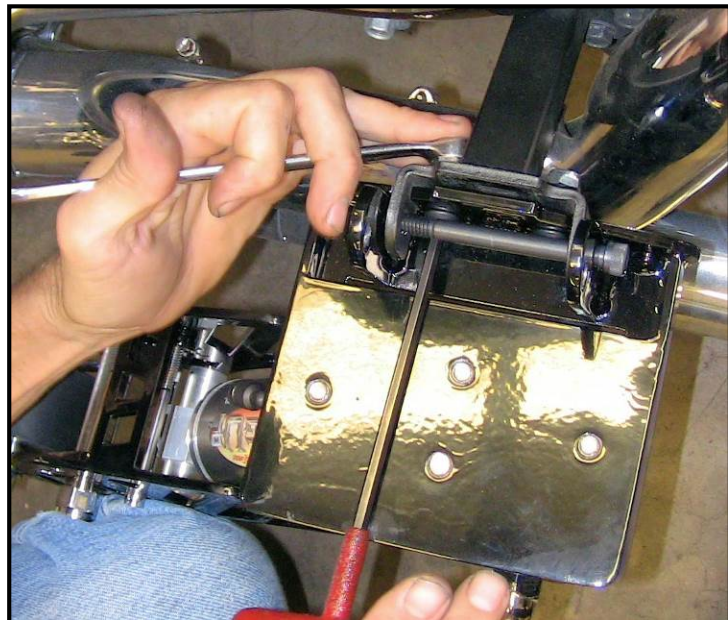
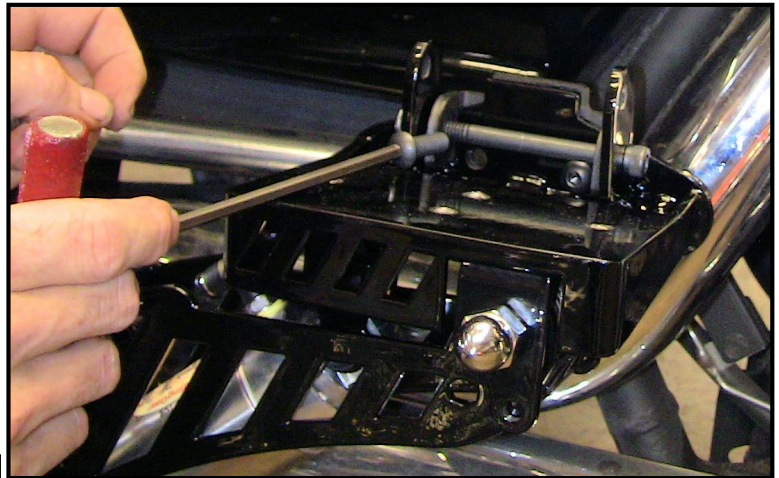

these started. Once you do, get two 5/16" locknuts, and start them on the bolts you just installed.

Tighten the button heads first, and then the long Allen bolts, once these three bolts are tight, give the whole assembly a good tug; it should be one with the motorcycle!

Now we have to give your passengers a place for their feet again!

The stock floorboards get mounted to the plate we just installed. Notice the upper holes in the bracket, just above the long bolt that mounted the leg assembly. Find another 5/16" X 3.5" Allen bolt, two 1/4" spacers, and a 5/6" locknut.

We start the bolt from the front of the bike, through the mount, a spacer, the floorboard (*the original floorboard washer, spring and ball bearing are not used!*), another spacer, and then the other side of the mount as shown here.

Put the locknut on the bolt and tighten until the floorboard can be lowered and raised, but is stiff so it will stay where it is put (Almost always down). You will notice a rubber pad on the end of the leg assembly that the floorboard will rest on. This replaces the rubber we removed from the floorboard mount!

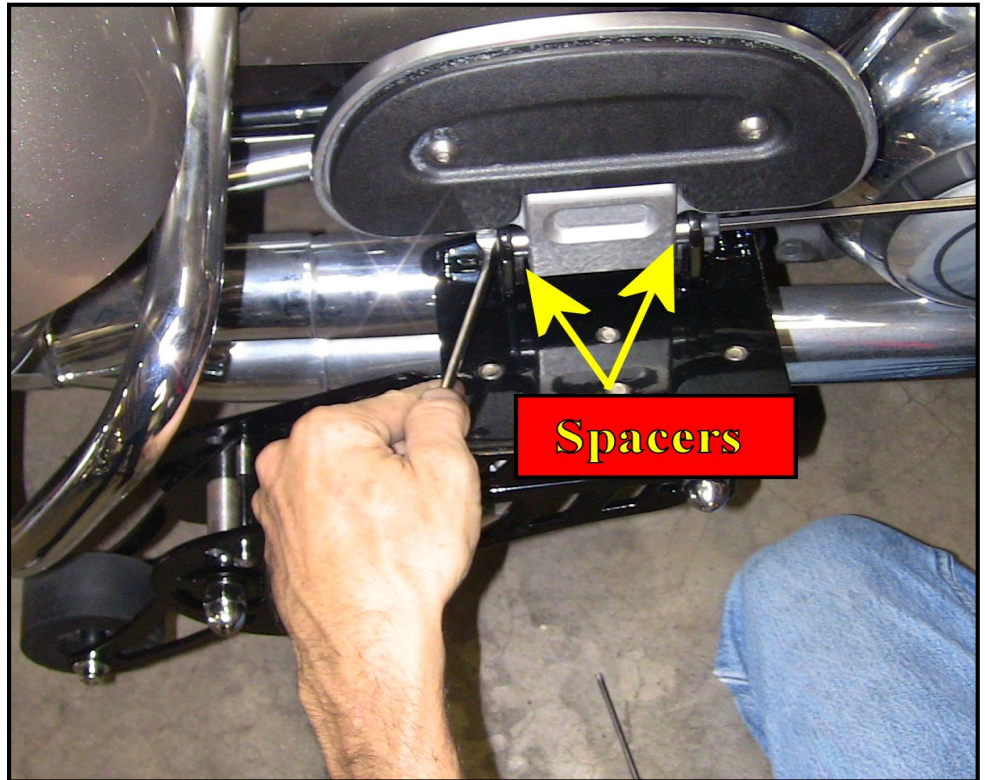

Repeat the same procedure for the other side.

Let's run the air lines!

RUNNING AIR LINES

We need to route the air lines to the cylinders; this way we can protect the excess, and ultimately pull them into the left saddlebag.

Let's start by attaching an air-line to the right cylinder. Pull the leg down against the spring, and press the end of the line into the fitting on the cylinder. Give it a tug to make sure it is connected well! Then run the line down the floorboard mount (loosely tie a wire tie to the arm of the mount), then under the lower side cover and ultimately under the seat. There is no real trick to how to run these lines, just make sure they are not in a bind or in danger of getting hot or crushed!

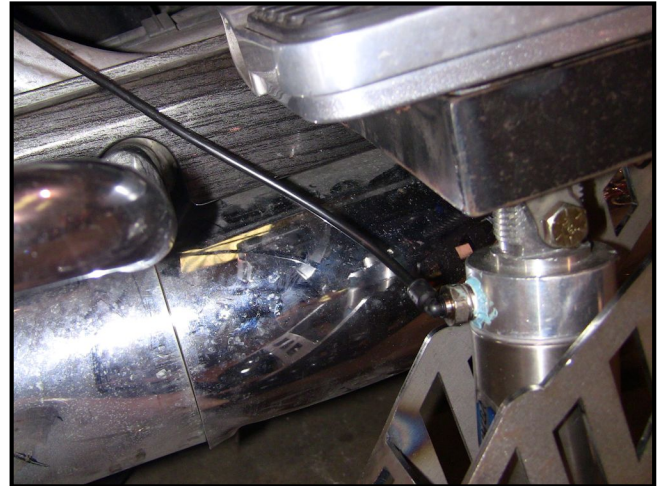

Manually run the leg up and down against the spring and make sure you have enough slack for this to occur. Tighten the wire tie on the floorboard mount a bit, to keep the line from moving, but not too tight. Then test the leg movement again and make sure the leg is free to move up and down without compromising the line.

Do the same thing on the other side of the bike. Once accomplished, we want to get the lines toward the left fender support as seen below. Make sure the line is safe from the seat and anything else that might hurt it and join it to the wire running toward the back of the left

saddlebag. All the extra slack from the lines will be coiled under the side covers. We don't cut the lines because we want to keep them the length that they are, and both the same length. Just leave them wild for now; we will clean and tie these up later.



These are air lines, so tie them off snugly. Careful though; too tight could restrict the air flow.

Let's get the saddlebag ready!

SADDLEBAG PREP

The compressor system will reside in the left saddlebag. In order to get the air lines and the wires to run to the compressor system and the wires to the computer, we need to make a small notch in the saddlebag.

As you see here, we made a notch about 3/8" wide and 3/8" deep. The picture here shows us making sure the wire and 2 air lines fit in the notch. The bag is ABS, and we used a rotary tool to make this cut, but a small saw or a file, could handle the job as well.

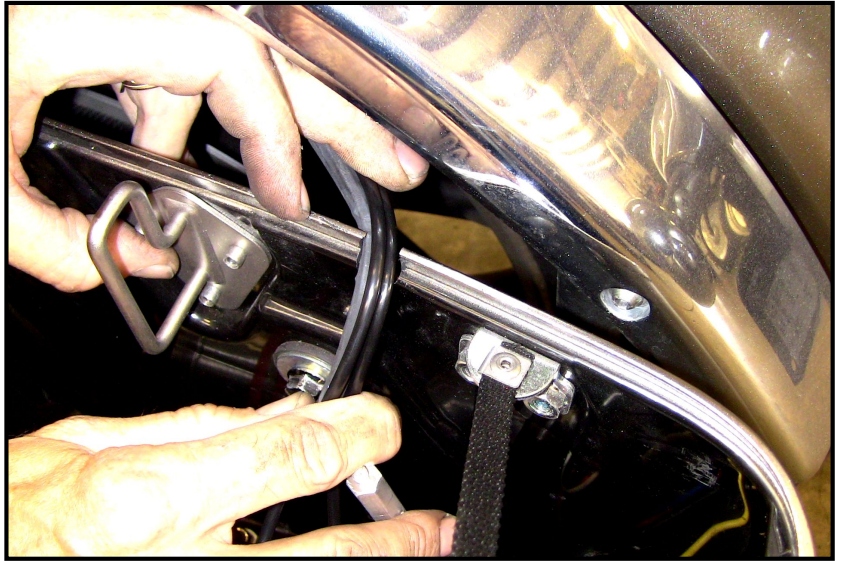

We actually should have cut this notch a bit more forward toward the metal bracket you see here. Position is not critical, but the lines and wire go into a notch on the compressor top later, and a bit further forward makes this a bit easier.

Earlier you marked a spot on the wire 10" from the big plug. This mark should be set just outside this notch, and the air lines should be pulled to the 12 pin plug, and then tied, at the mark, to the wire. This establishes how much extra air line and wire we have.

Now that these are tied together, we can start from the back, and tie off the line and wire tighter under the fender strut, while taking the excess back toward the seat area. Once this slack is under the seat, extra air line should be pulled under both side covers and coiled up and tied loosely and safely there, rather than under the seat. The extra wire stays under the seat, but the extra hose is safer under the side covers.

Let's install the compressor!

INSTALL THE COMPRESSOR

Find the compressor, as shown here. We need to remove the top, as it won't be needed until the very end! We do this by removing the three nylon nuts on the top of the plate. These are only hand tight and they will be reinstalled without any tools as well.

The compressor has rubber feet and just stands in the left saddlebag, all the way toward the back in the position you see below.

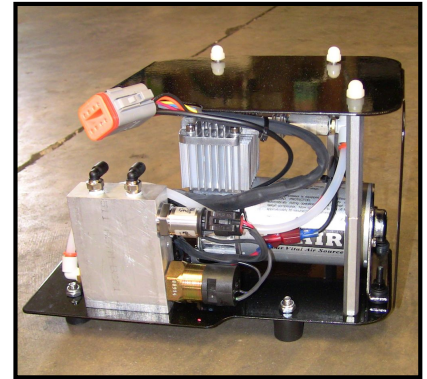

Place the compressor in the bag, then plug the 8 pin plug from the compressor into its' mating plug from the wire coming through the notch on the bag. Take the two air lines, and attach them to the fitting on top of the valve system you see to the right of the picture. Tug on the lines to make sure they are tight in the fittings!

Find the Computer, and plug it into the remaining plug in the bag.

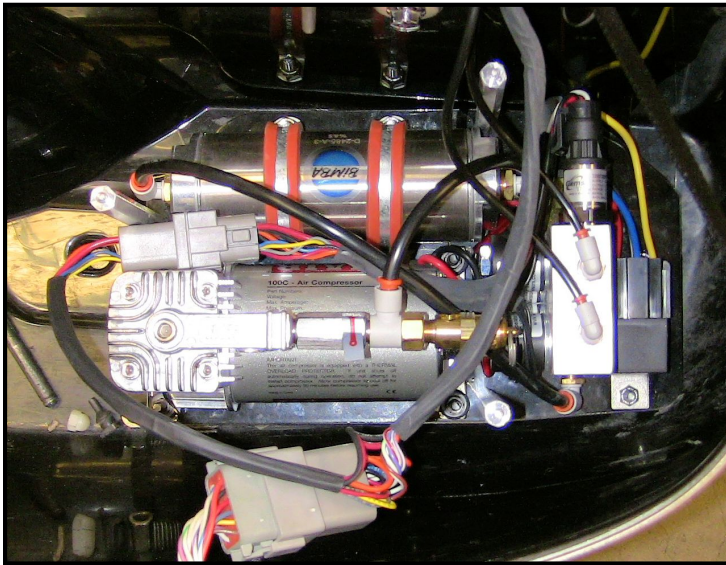

Below we show what this system will look like when done, but for now just keep the computer loose and the top off; we will need to check for leaks. We will clean this up later!

We are about to do some initial system testing so make sure that the negative terminal of the battery is connected, and the fuse holder we installed has the fuse in it!

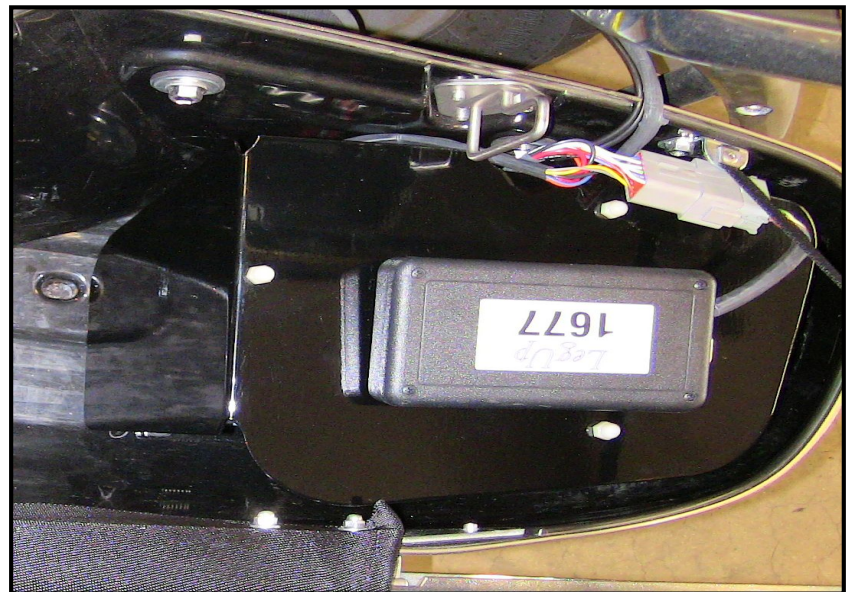

INITIAL SYSTEM TEST

Turn your key switch on. At this point, have a look at the yellow proximity sensor (it should be dangling near the left shock somewhere). If everything is working properly, the compressor should turn on for about 6 seconds to fill the onboard air tank. At this point, have a look at the yellow proximity sensor.

PLEASE NOTE: Immediately after turning on your bike (within 5 seconds), the top light on the handlebar control will flash for a few seconds. This is the system either making sure that no air is in the legs if they are up (for safety it makes sure air does not build up when the legs are in the up position), or that the proper amount of air is in the system if they are down (again for safety to make sure the legs stay pumped completely!). This test occurs once a minute for all the time the bike is powered up, whether you turn the LegUp system on or not!

The **RED LED** (ON The Sensor) ***Should Not Be Lit***. Take a metal object (screwdriver, wrench, etc.) and hold it on the flat face of the sensor (it has a circle embossed in it). The LED should light up, and go out when you move the metal away. If not, check all your connections.



Next, press the rightmost pushbutton on the handlebar switchbox, and hold it for at least 3 seconds. Both LEDs on the switch panel should light up; green means the legs are up and yellow means the bike is traveling under 6MPH. If this occurs, you are doing well.

The next step requires some care. If the bike is still on the lift, have a helper hang on to it as you touch the left button for just a split second. The legs should move down, likely until the wheels hit or miss the lift, and they do this **VERY** quickly! The compressor will likely start and run for about 10 seconds. Press the left button again and they should move up.

If all of the above has occurred, great! Turn the ignition switch off, the test is complete!

Let's move on to mounting the Proximity Sensor.

MOUNT PROXIMITY SWITCH

This step is crucial!!

Understand it before starting. The proximity sensor tells the system how fast the bike is traveling. The proximity sensor mounts to the lower left shock bolt. The sensor will ultimately be mounted 5MM from the pulley bolts.

Remove the cap nut and lock washer from the left rear shock. The proximity bracket with sensor should be in the area of the shock already.

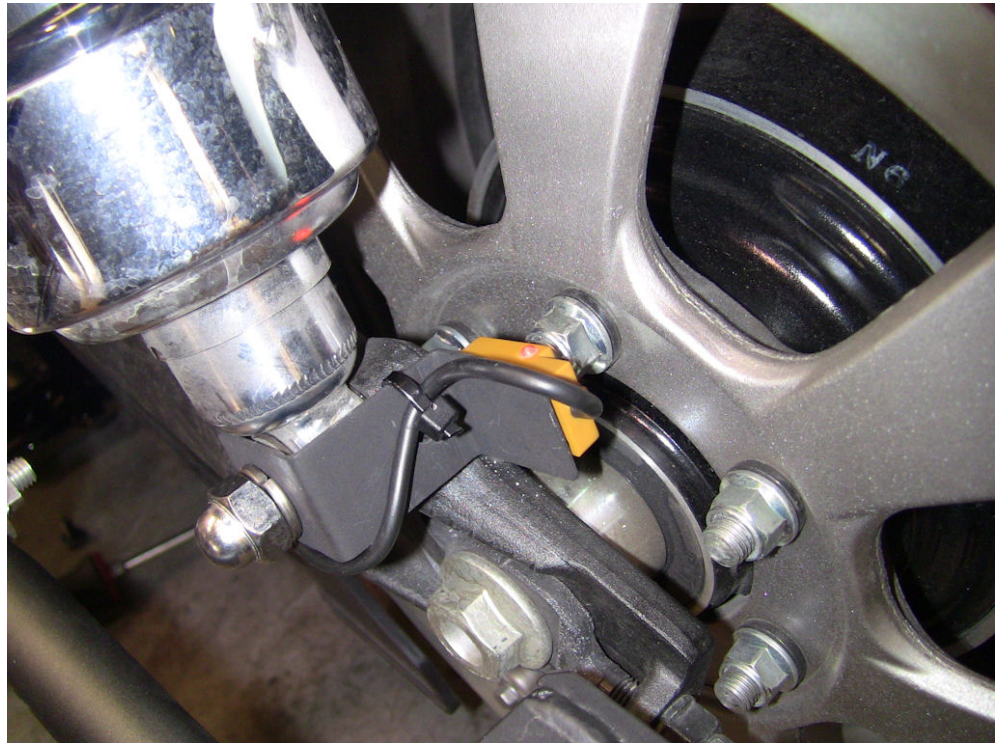

Slide the bracket on the shock bolt and reinstall the lock washer and cap nut with a bit of Loctite. Do Not tighten completely yet. The bracket must be rotated to the proper position for it to work properly. Notice the orientation in the picture here; we want the bolt to cross over the middle of the leftmost area of the face of the sensor.

It would be very helpful if you can jack the rear wheel off the ground or lift for this operation. The idea here is to have the yellow proximity bracket line up with the pulley bolts and be placed no more than 5MM away from them as they rotate! The picture shows the bracket perfectly aligned and also shows how we tied the wire to the bracket, before routing it up the swing arm to get under the seat.

Turn the ignition switch to the on position. The LED may or may not be on. What we are looking for here is for the LED to light as a pulley bolt passes close to the sensor and to go out as the bolt passes by. Have someone watch the LED as you roll the wheel, or the bike, back and forth making the bolts pass close to the sensor.

Once you feel you have the right place, tighten the cap nut down securely, and test again!

If this is not happening, you may need to get the sensor a bit closer to the bolts (5MM is a very small distance!). If you have to move the sensor closer, you may have to bend or adjust the angle of the bracket.

No matter what you need to do, you **MUST** make sure that as the wheel turns, the light works as described above! The automatic retraction of the legs as well as their deployment **RELIES** on this sensor being placed perfectly!

Once satisfied with the mount, skip down to the wire routing instructions below.

WIRE ROUTING

Guide the wires from the Proximity bracket up the swing arm, and route it under the seat.

Secure all wires (we used self-adhesive holders shown here), as you don't want the belt or any moving parts interfering with your work! Take whatever extra slack from the wire you can and pull it under the seat. We will be neatening everything very soon.

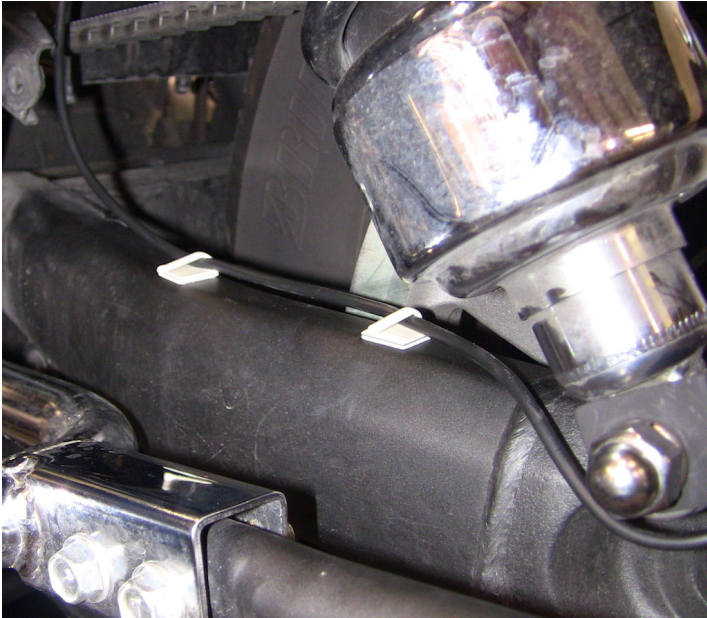

Use wire ties to make sure that all wires and air lines will stay where you put them and that they will not come in contact with anything that moves. Loop any excess as shown here. Keep the excess wire clean and make sure the seat goes on and off without hitting any wires. If you keep all plugs inside the frame rails as shown, the seat will fit fine. It may take a few tries!

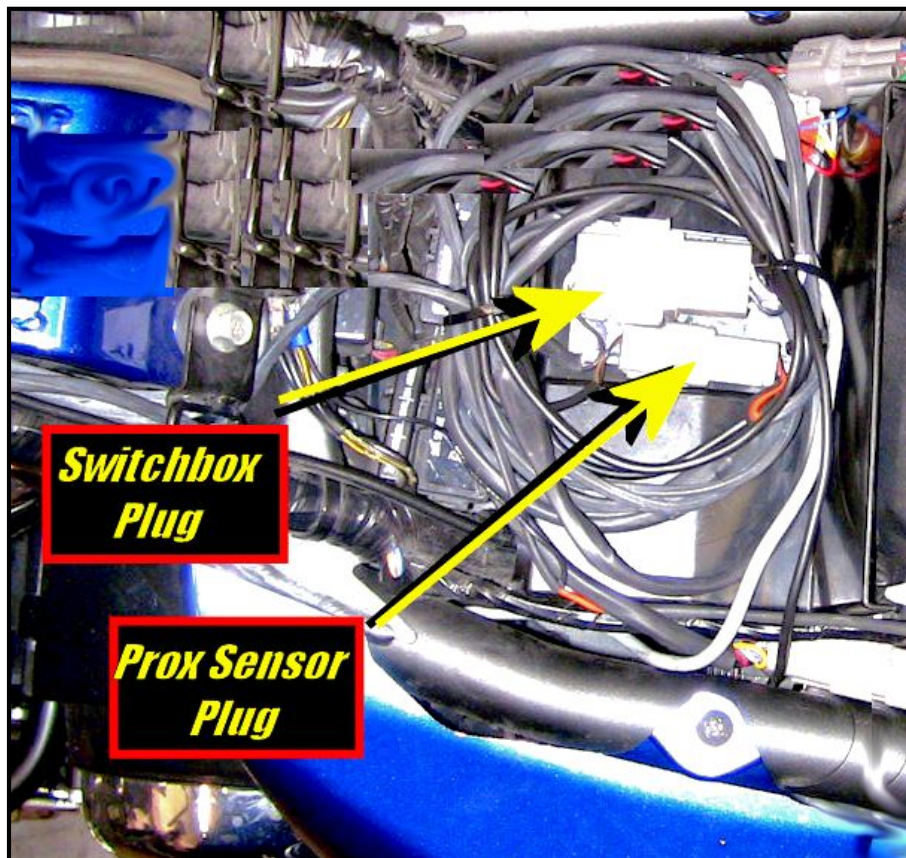

FINISHING UP

Now it is time to reinstall everything you took off, and do final checking of everything! Reinstall the seat making sure all your wires are routed neatly, tied off nicely and don't interfere with the seat installation. Side covers go back on making sure the wires to the battery and fuse box are neatly stored, and the air lines are not in any sort of bind!

Once all of this is accomplished, we should get the bike on the ground, and with a helper, cycle the wheels up and down manually a few times, having your helper make sure the air lines are not being scuffed or are over tight, and that the lines are out of the way of anything that could damage them. Double-check all your bolts for tightness. Now we can dial in the legs, and adjust the wheels if needed.

LEAKS!

This system uses air, and air loves to leak! The fittings we use are tested for leaks before shipping, but we have a few simple tests to make sure you have no leaks or just insignificant ones if any.

Set the wheels down and leave the system on. Put the kickstand down, and turn the bars all the way left.

If the compressor makes noise more than once every two minutes, you may have a leak at the lines that connect to the compressor or the tank fittings. Some soapy water will tell you where (you will need to remove the compressor top to test for these leaks).

Assuming the compressor doesn't lose enough air to kick on after 2 minutes, you should be fine.

You can turn the bike off, and wait to see if in 5 minutes the bike is not as stable as it was when the wheels were first lowered. If it lasts the 5 minutes and is still very stable, you could still have a leak, but not one that would be a problem on the road!

Leave the bike on its wheels overnight (again kickstand down, bars full left in case the legs lose a lot of air; the bike will land on its stand). If in the morning, the bike is still stable you have no leaks.

If there are leaks, the fittings on the air cylinders would be the first for the soapy water check, with the two small line fittings on the compressor next! If you need help with these, please feel free to call us at (407) 834-5007.

FINAL ADJUSTMENTS & MAINTENANCE MODE

The next two sections are typically **NOT** needed. We include them to document your system thoroughly, but **MOST** people will never need to use either section.

MAINTENANCE MODE

NOTE: Maintenance mode is a procedure that ‘TEACHES’ the computer how much pressure to use when it lowers the wheels and how much pressure to release when raising the wheels. We always set this at the factory; ALWAYS!! We include this procedure in case it is ever needed in the future. Please skip this section unless you have been instructed to reset the system by Chopper Design.

Turn the ignition to Accessory and start the LegUp System (hold right button for 3 seconds). The system should be set at the factory for proper pressure, but some wheel adjustment may be needed. If it has been determined that **‘Maintenance Mode’** is needed, Sit on the bike, and hold it level. If both lights on the switch box are flashing, the system is in maintenance mode. If not, **PRESS & HOLD** both buttons until all lights flash. ***(Do your best to press both buttons at the same time so the system doesn’t respond to what it thinks is a request to lower the legs)*** Once flashing, hit both buttons for an instant to get the system in the **‘DOWN’** setting mode (lower, yellow LED flashing). Touch the left button briefly; the wheels should go down immediately. ***(This is VERY quick, don’t be startled!)*** Using very short pushes of the left button, press and then feel the stability of the bike. If it feels firm enough, try leaning the bike a bit. If the wheels return the bike to upright, there is likely enough pressure. Put your feet on the floorboards; the bike should stand on its’ own. Rock the bike a bit left and right, being prepared to put your feet down. If the bike continues to come back to upright, the **DOWN** stop is now set and we can move on.

Hit both buttons for a moment to get into the **‘UP’** stop mode (Usually hitting the left button just before the right assures that air is not released!) The top LED should now be blinking. Press and hold the right button to raise the legs. Listen as the air evacuates; once it is quiet, let go of the right button. The **UP** stop is now set! Hit both buttons when complete, Both LEDs should light, and you are done with these adjustment.

Now press the left button and the legs should lower; again this is fast and loud. The bike should be held up firmly! Hit it again and the legs should retract. If you are satisfied with these limits, you have successfully installed the LegUp System.

WHEEL ADJUSTMENT

The LegUp GEN II system is typically set up at the factory for the height of your bike. The system is VERY height dependent! If after testing the initial installation, the bike does NOT feel stable, the wheel system MAY need to be adjusted to the height of your bike. AGAIN, we normally ask at order time if your bike is at stock height and we set the system up for whatever height you have furnished us. DO NOT make any changes unless the stability we expect is NOT present! If you feel you need to adjust the height/length of the wheel holders, please read this ENTIRE section before starting the process. If you need help, please contact Chopper Design at 407-834-5007.

If you are happy with how stable the bike feels, you can skip this section, and move on to a test ride! If you are not sure, or you skipped **'maintenance mode'** as instructed, a good test is to bring the wheels down, put the kickstand down, and lean (or try to) the bike on its kickstand while sitting on the bike. If the bike comes back to center without your help, or you put your feet on the boards and can bring the bike up by just leaning to the right; move on to the next section (Test Ride), the wheel settings are fine!

The stability of the GEN II LegUp system, relies on the pneumatic actuator, when deployed, being at an angle that is forward of perpendicular for best results! Different bikes are at different heights, and Chopper Design uses an ingenious method to adjust the length of the supporting legs to maximize the stability it affords.

Typically, we will send the 'Leg Assemblies' set up for perfectly for your bike. In the event your bike is at a different height than stock, the information and adjustments that follow may be required.

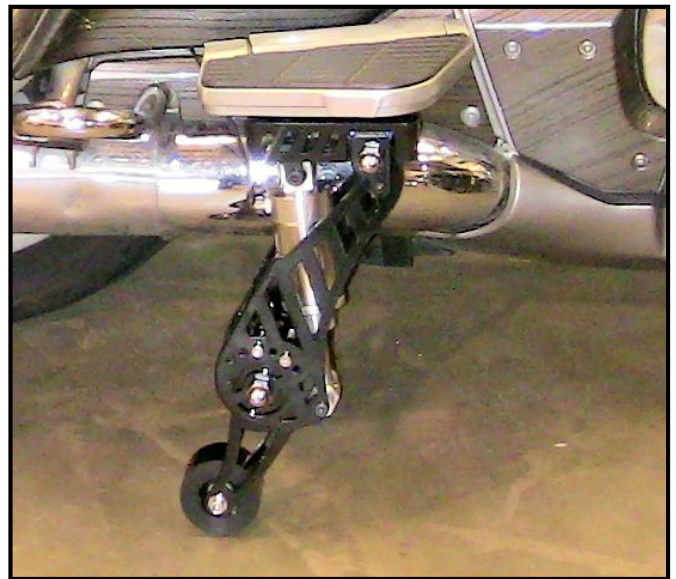

On the next page, we show you the wheel holders which should help clear up any confusion you may have about the wheel holders and their adjustments.

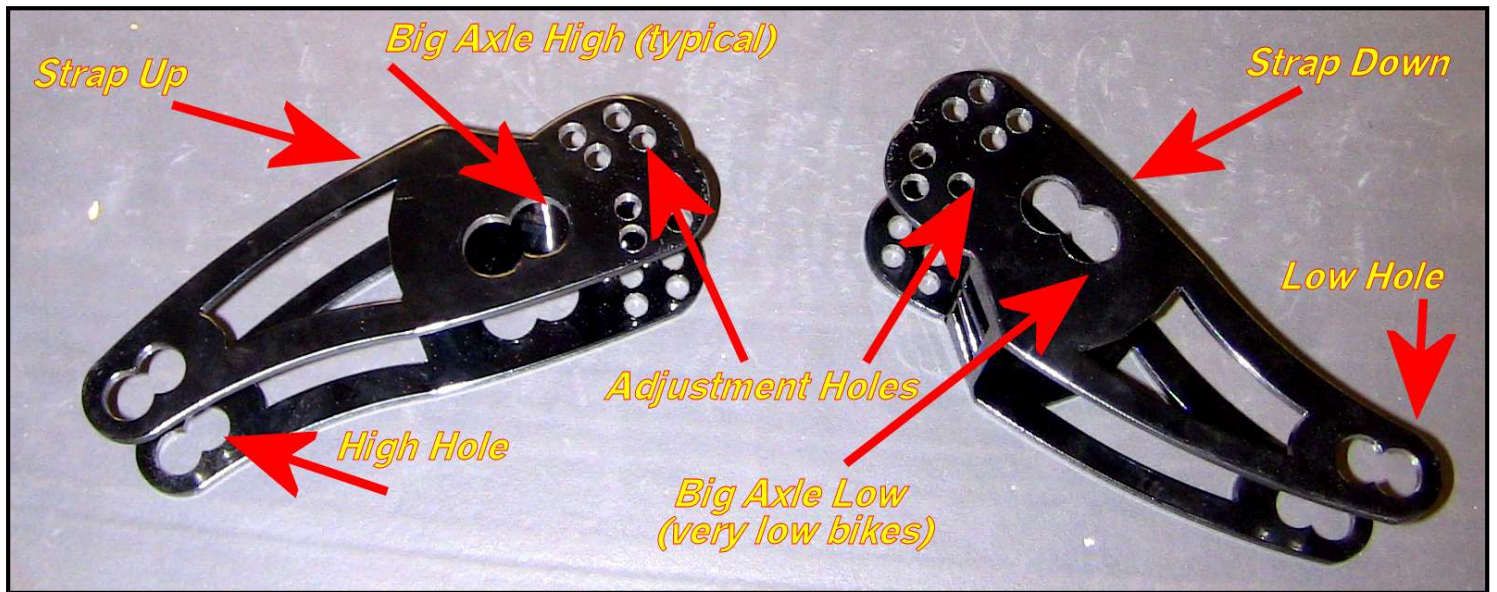

On each supporting leg, you will find two bolts down near the end by the wheels. The two bolts control the angle of the ‘Wheel Holders’. By moving the wheel forward or back, we can tailor the length of the support arms to a particular bike.

A helper is handy here. Make sure the wheels are up. Make note of exactly which two holes the bolts are in. Loosen the locking nuts from the back and remove the bolts; you will notice the ‘Wheel Holder’ can pivot on the big axle bolt. Starting on

the left side of the bike, move the bolts one hole counter-clockwise. Go to the right side and move them one hole clockwise. Loosely fit the nuts (no need to final tighten them at this point).

Lower the legs. Is the bike more or less stable? If it is more stable, and you can sit on the bike and rock it back and forth without it leaning over you are done. If not, remove the bolts again, and move them in the opposite direction two holes, and retest. If everything is fine, final tighten the lock nuts and you are done.

If you need to, you can move the wheels from the lowest hole, up one hole. You can remove the wheel holders, turn them over (strap up instead of down for example) and install them on the other side of the bike. You can move the big axle from the low to the high hole. All these techniques take patience, but allow significant flexibility to tailor the system to your bike. On the next page we show you some examples. Normally you do not need to do ANY of these adjustments, but if you need to, we wanted to teach you the methods at your disposal.

TEST RIDE

PLEASE NOTE: Immediately after turning on your bike (within 5 seconds), the top light on the handlebar control will flash for a few seconds. This is the system either making sure that no air is in the legs if they are up (for safety it makes sure air does not build up when the legs are in the up position), or that the proper amount of air is in the system if they are down (again for safety to make sure the legs stay pumped completely!). This test occurs once a minute for all the time the bike is powered up, whether you turn the LegUp system on or not!

Get the bike to a clear paved mostly level area where you can test ride it. Start the bike, turn on the LegUp system and lower the legs. The first test should be done in a straight line. Put the bike in gear and slowly accelerate. You may notice that the bike tends to want to steer a small amount left or right. This is normal unless it is severe. Effectively, you are driving a trike, and steering is done with the handlebars **NOT** by leaning. Once underway, (we recommend you keep your thumb near the left button, and press it to raise the wheels if there are any surprises) the top LED should flash at around 6 MPH, meaning the legs are retracting. It is difficult to lean on one wheel or the other as you leave, so you may wish to raise the wheels manually if the bike is steering due to uneven pavement.

Assuming the legs are retracted, you should try to deploy the wheels. As you come to a stop, the Green LED should be on. As you slow down (**almost stopped**), the Yellow LED should illuminate at the proper speed. Once it does (sometimes hard to see), hit the left button and put your feet down near the ground. The top LED should flash and the wheels should deploy almost instantly underneath you! Make sure you are ready to balance the bike, though you likely won't have to! Immediately after the wheels touch the ground, the bike should be supported reasonably, but the cylinders can take up to 6 seconds to get completely filled. Make sure you balance the bike as this occurs. The slower you are going when deploying the wheels, the smoother the transition will be from wheels up to wheels down. Practice these maneuvers until you are comfortable with the wheel adjustments and the system operation.

NOTE: With the system on or off, if the legs are up, the computer will dump the air from legs once every minute that the bike is turned on! This is a safety feature to make sure pressure does not build inside the legs, causing them to deploy! The top light will flash once a minute for a few seconds. This is completely normal, and the left button will be inoperable while this occurs.

SEMI-AUTOMATIC DEPLOYMENT: Another way to deploy the legs is semi-automatically. First we must be **SURE** that the proximity sensor is working properly or the wheels could come down at higher speeds than we wish. If you are travelling at a speed over 10 MPH, AND the yellow light (bottom) on the handlebar control is out, hit the left button. The bottom or yellow LED should start to flash. When you slow down to around 5MPH the wheels will deploy (see the red/green flash on top LED). Again prepare to put your feet down. IF the lower LED is lit at a speed over 10 MPH, don't hit that button; see caution below!

NOTE: The bottom LED Should not be LIT SOLID if the bike is travelling over 10MPH! In the event it is, the wheels will deploy instantly if you try to set them as above; this is dangerous! You MUST re-visit the sections on testing the proximity sensor. You should always be aware that this light should NOT be on if you are traveling at speed, and 'Arming' the system for deployment should only be attempted if the lower LED is Not Lit! Please see the User Manual for more information on Proximity Sensor Failure!

The next thing to try is to make a turn from a dead stop with the wheels down. As soon as you start the bike moving, turns can only be made by using the handlebars. The LegUp system is too strong to allow a great deal of lean with the wheels down! If you need to make a turn shortly after departing from a stop, raise the wheels manually (left button) and you will get complete control again.

The next thing to try is slow speed maneuvering with the wheels lowered. If you keep your speed down, most slow speed maneuvers can be accomplished with your feet up, keeping in mind that at about 6 MPH the wheels will come up automatically! You can try full lock turns in both directions and the bike should stay upright with your feet up.

Understand; it is always a good idea to keep your feet near the ground during these maneuvers if you can. A mechanical failure or a wheel in a pothole could upset the bike.

Because the wheels are right behind your legs when they are down, we recommend not trying to push with your feet to move the bike forward. Use the engine and keep your feet out of the way; this way the legs don't bite at your heels as the floorboard always have! Backing up using your feet works fine and the chore of balancing the bike is taken care of for you.

Practice, practice, practice!! Enjoy your LegUp System!

ILLUSTRATIONS

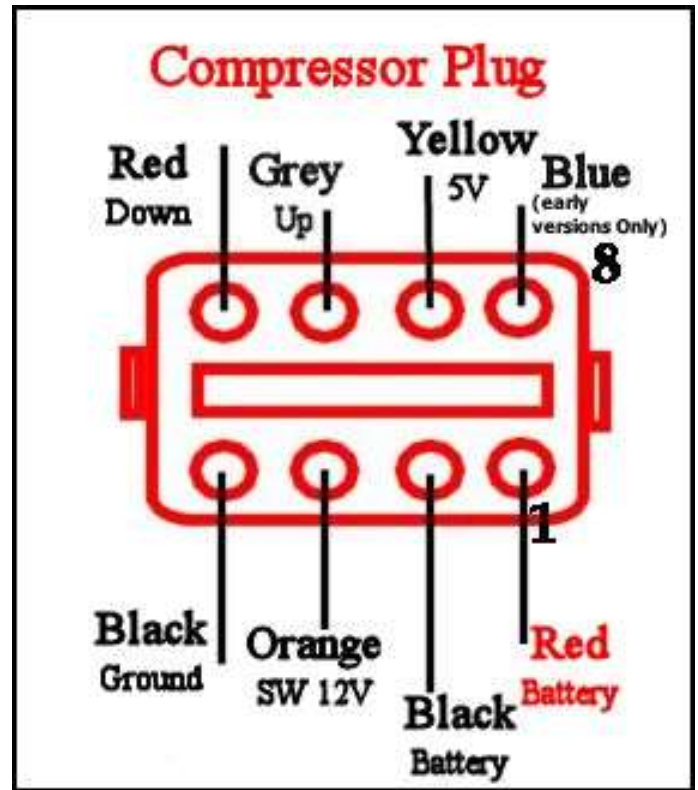
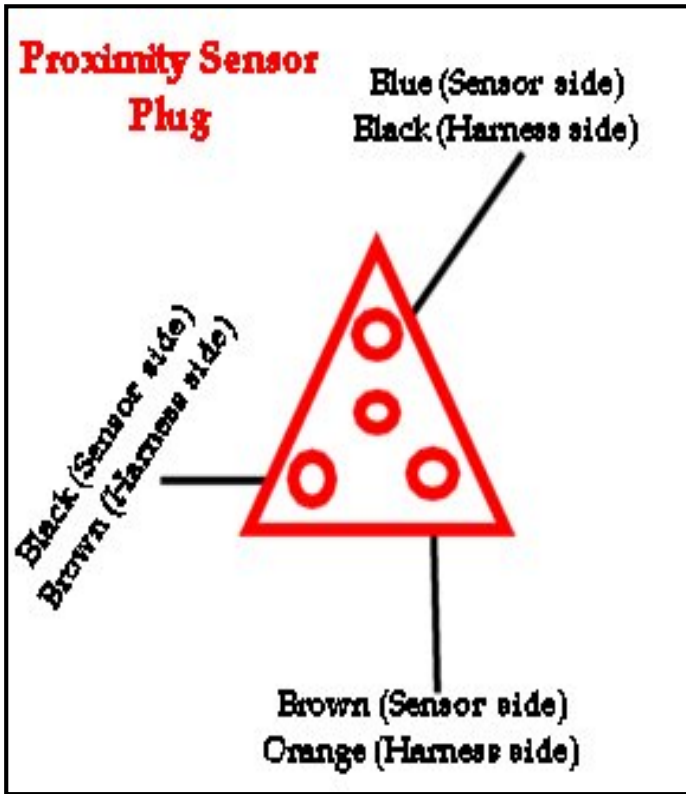

Due to global distributions problems, we may have to use a four pin plug instead of a 3 pin plug. The colors still need to be the same across the plugs with pin 4 empty!

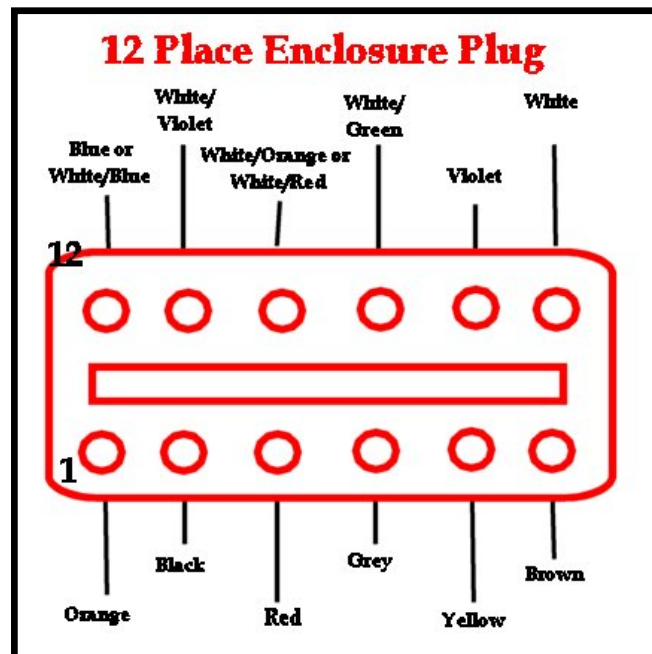

PARTS LIST

- (4) 5/16"-18 X 3 3/4" Allen Bolts with Nylock
- (4) 5/16"-18 X 7/8" Button Head Bolts with Nylock
- (4) 5/16" ID X 1/4" Wide Spacers (Floorboards)
- (1) 10-32 X 1 1/4" Chrome Allen (Switch Box)
- (2) 2' Air Lines
- (2) 5' Air Lines
- (2) Female/Female Air Fittings
- (2) Self-adhesive Rubber Squares (top of leg mount)

Electrical Connector for female spade
Spare 5' Air Line

Set Computer to 6 Bolt like GL1800