



Installation Manual Generation II Indian Roadmaster

**Copyright 2016, Pete Giarrusso, Inc.
D/B/A Chopper Design Services
All Rights Reserved**

Table of Contents

INTRODUCTION	4
WARRANTY	5
INSTALLATION INSTRUCTIONS	6
1) <i>Wire Harness W Switch Box</i>	6
2) <i>Leg and Mount Assembly (L/R)</i>	6
3) <i>On-board Computer Module</i>	6
4) <i>Proximity Sensor</i>	6
5) <i>Saddlebag Mounted Compressor System with Tank</i>	6
6) <i>Hardware Bag</i>	6
PREPARE FOR INSTALLATION	7
CONTROL SWITCH BOX.....	8
WIRING HARNESS	11
LEG & MOUNT ASSEMBLIES	13
MOUNT BRACE (OPTIONAL).....	15
SADDLEBAG PREP	16
RUNNING AIR LINES.....	18
INSTALL THE COMPRESSOR	20
MOUNT PROXIMITY SWITCH.....	22
WIRE ROUTING	24
FINISHING UP	25
<i>FINAL ADJUSTMENTS & MAINTENANCE MODE</i>	26
<i>MAINTENANCE MODE</i>	26
TEST RIDE	29
SADDLEBAG DRILL TEMPLATE	31
PARTS LIST	34

Introduction

This manual covers installation of the Generation II LegUp LandinGear system by Chopper Design Services. This system should only be installed by a qualified technician, or those with above average mechanical skills. If you are not **SURE** that you can perform this installation, please contact us and we will help you find a qualified shop to assist you.

While the Generation II System holds your bike upright very well, you are **STILL** responsible for balancing the bike! The system **WILL** relieve you of some of the weight of the bike and help you avoid balance problems as you approach a stop, maneuver at slow speeds, and back the bike up.

Improper installation will void your warranty, so please be very careful!

Thanks for choosing LegUp!

Warranty

Chopper Design Services warrants the LegUp system for a period of one year from date of purchase. This warranty covers replacement parts and/or manufacturer defects. Incidental damages or costs are the responsibility of the purchaser.

Defective parts are to be returned to Chopper Design at the address below. Purchaser must contact Chopper Design to receive a Return Material Authorization, prior to returning defective parts to Chopper Design.

Abuse, improper installation or use, collisions or accidents, are not covered under this warranty. Replacement parts for this type of damage are available through Chopper Design.

Users of the LegUp system agree that Chopper Design is NOT responsible for personal injuries or damage to property arising from the use of the system. While we believe this system to be safe and reliable, the user is advised that use of LegUp is done so at the users' own risk. Use of the system implies agreement to the above statements. If you can't agree with the above, Chopper Design and its dealers would be happy to refund your full purchase price, before you use the LegUp System.

Chopper Design Services
1365 Bennett Dr #101
Longwood, FL 32750

407-834-5007
LegUp@LandinGear.com

Installation Instructions

The LegUp® system has many components. Please be sure you have them all before starting your installation.

COMPONENTS:

- 1) **Wire Harness W Switch Box**
- 2) **Leg and Mount Assembly (L/R)**
- 3) **On-board Computer Module**
- 4) **Proximity Sensor**
- 5) **Saddlebag Mounted Compressor System with Tank**
- 6) **Hardware Bag**

If you believe you are missing any parts, please contact Chopper Design at 407-834-5007, and we will rectify the situation. Some of the parts are shown below.

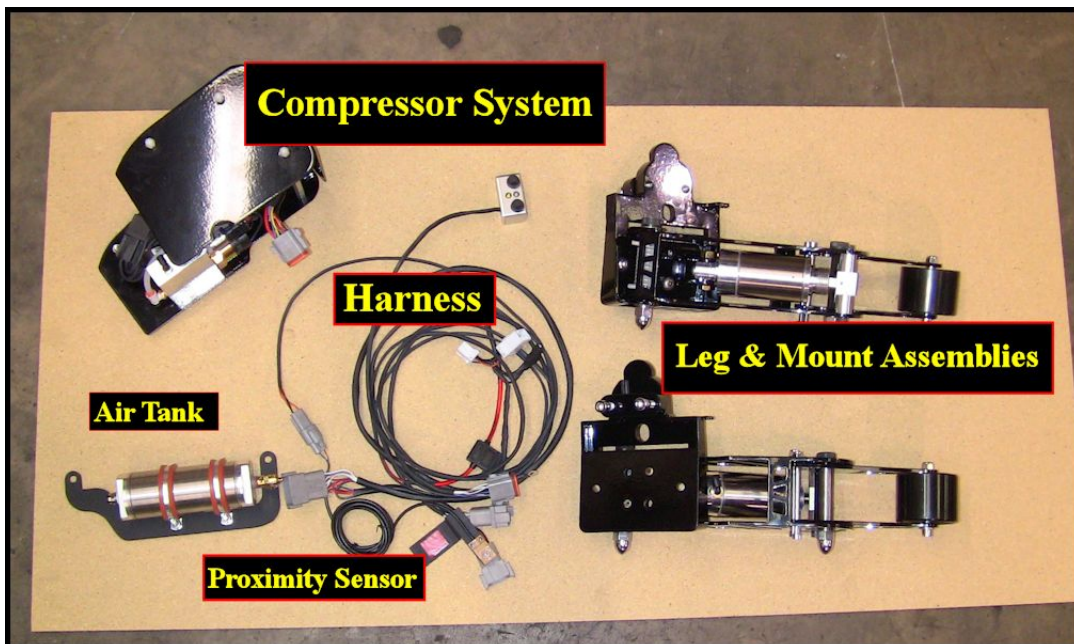

PREPARE FOR INSTALLATION

IMPORTANT! *Indian Roadmasters® must be STOCK in order to install LegUp. Any deviations from stock may make installation impossible. Indian Chieftains that are fitted with Indian Part #2880288, Floorboard Mounts and rear floorboards will work with this system. The Chief Vintage Model would also require Floorboards, but a custom compressor system for the saddlebag will be required. Contact Chopper Design for help with fitment on anything but a completely 'STOCK' model.*

Place the motorcycle on an acceptable bike lift. You will need to keep the bike on its wheels for most of the installation, and jack the rear wheel off the lift for some portion of the installation. Make SURE the motorcycle is secure on the lift!

Remove the seats, rear luggage box and both passenger floorboards; they are not needed until the very end of the installation.

This manual is available at <http://landingear.com/pdf/g2installindian.pdf> . It may be easier to see some of the pictures in color there!

We are now ready to begin!

CONTROL SWITCH BOX

Disassemble the 6-pin connector attached to the switch housing. The switch wires will run down the handlebar and ultimately under the tank to the area under the seat.



You will need to remove the two Allen head screws that hold the clutch perch to the left side of the handlebar. Using the 6MM screws and $\frac{3}{4}$ " spacers provided, run the screws through the handlebar mount, and then the spacers, then using some blue Loctite, thread these bolts back through the clutch perch clamp, as shown.

Run the wires down between the switch housing and clutch perch as shown below. It is tight but is the cleanest way to get the wires

down the handlebar toward the front of the tank.

At this point we need to find the proximity sensor & bracket and get the plug off the end. The wires from this sensor need to be routed from the right fork area, up toward the handlebar, to join the wires from the switch box (See left picture below). Route the wires under the fork leg. The picture shows the chrome caliper cover

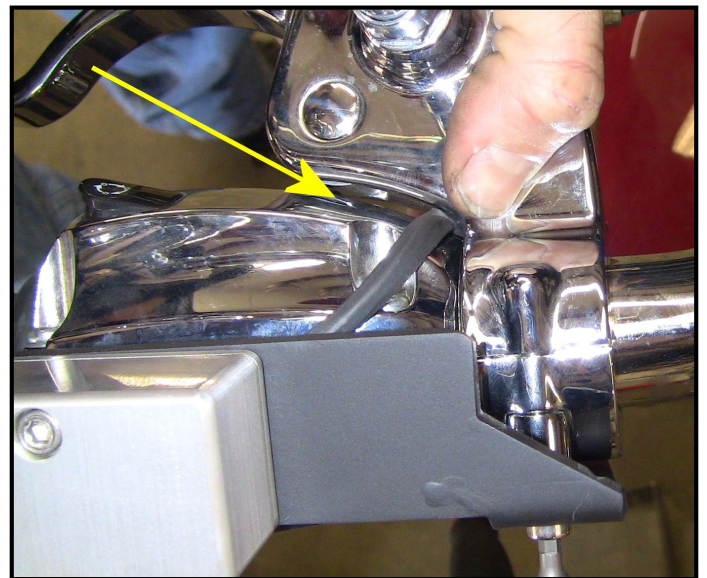

already removed, and how we tied the wire off to the brake line on its way up to meet the other wire. Leave the Proximity Bracket dangling for now as seen here.

Next, we need to get the wires together and under the tank so we can get them in the area under the seat.



We used a welding rod and fished it under the fuel tank, from the seat area forward, as you see here (below right). The left picture shows how we routed the proximity bracket wire around the front of the neck and the arrows in the right picture shows the two wires we tied together to get under the seat.

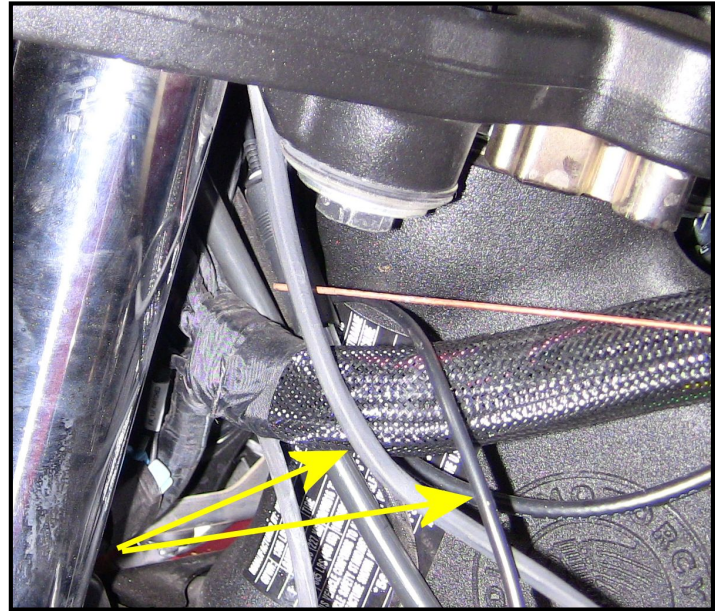
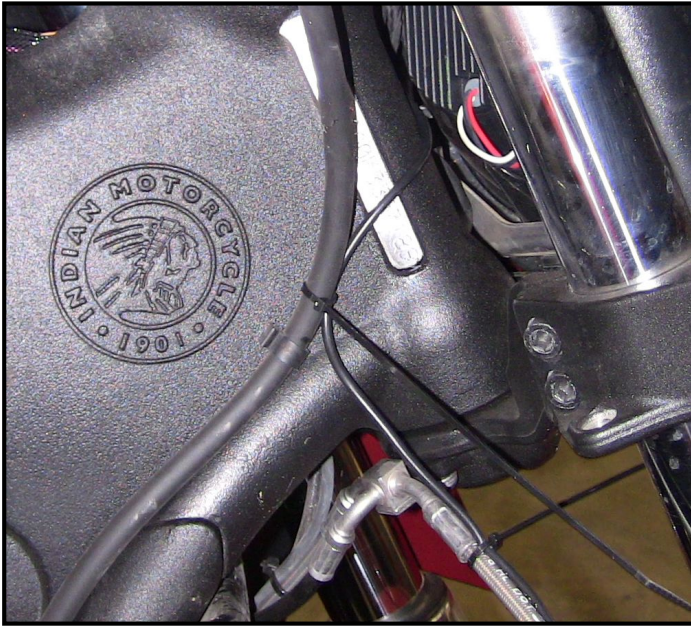

Next, we tied the wires from to the end of the rod with electrical tape, and gently pulled them under the seat. The picture below shows where the wires emerged. Once complete, we removed the tape and re-assembled both plugs carefully.

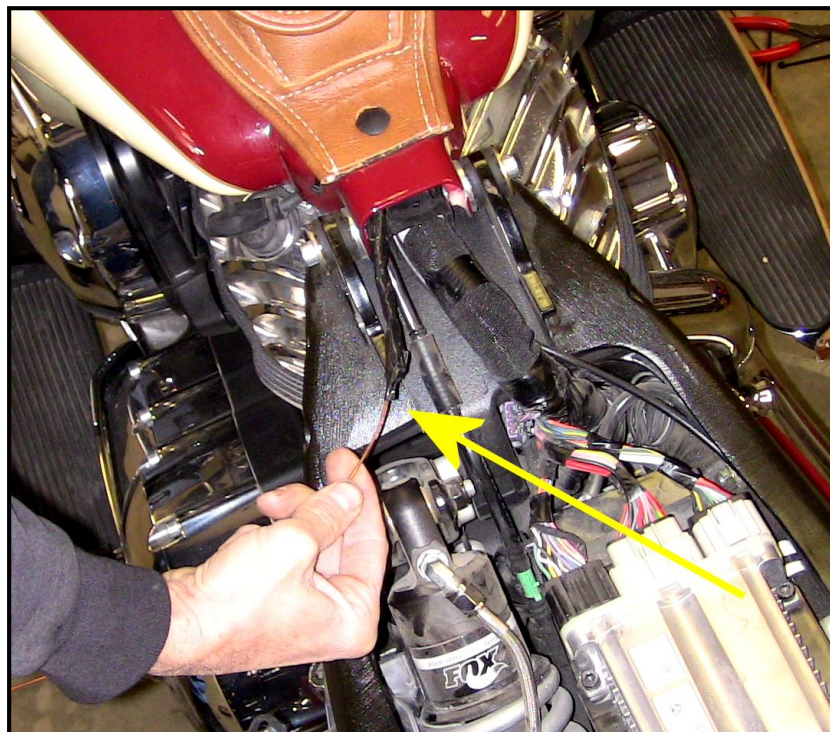

The picture here shows the two plugs reassembled in the under seat area. We will connect these in a bit and show you how we need to stow these wires for safety later. Note the detail pin-outs in the lower diagrams. Now on to the wiring harness!

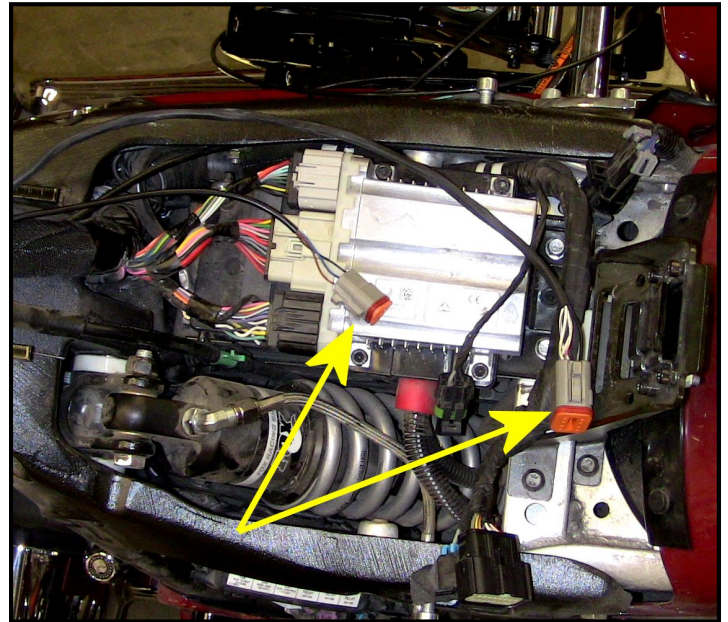
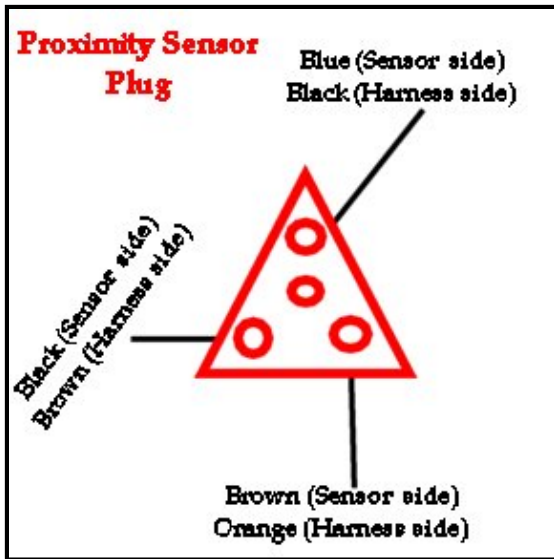

Due to global distributions problems, we may have to use a four pin plug instead of a 3 pin plug. The colors still need to be the same across the plugs with pin 4 empty!

Some bikes may have an 8 pin plug from the control switch box and some may have 6. In either case, there are only 6 wires and they are assembled in the plugs as below!

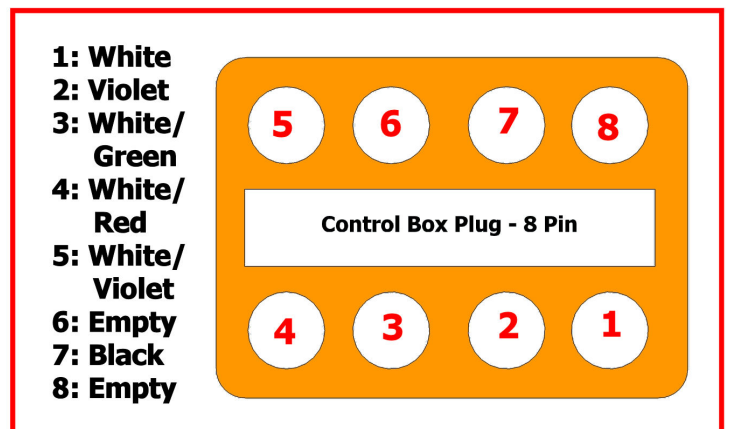
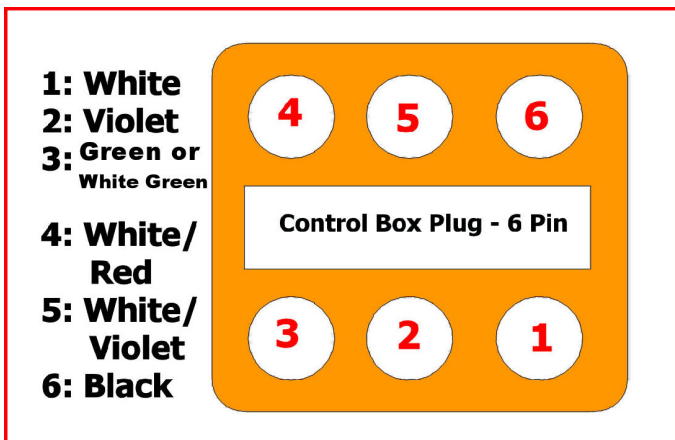

WIRING HARNESS

The next step is to route the wiring harness. We already ran the wires from the handlebar switch & proximity bracket, so those plugs should be under the seat already.



Find the two BIG plugs on the harness (12-pin with an 8-pin pigtail attached), and measure 18" from the point of the fender support to the 12-pin plug. We need this amount of wire to be able to go into the saddlebag.

Once this has been

determined, start tying the wire back toward the seat area by threading wire ties under the fender brace as shown at right. Notice that the harness runs under the top of the rear crash bar and into the area under the seat. Get the wires into this area and we will start connecting everything under there.



We need to remove the ECM so we can get to the battery. It takes one bolt to remove it (the middle one toward the back). With the battery exposed, find the wire that has 2 hoop connectors on it.

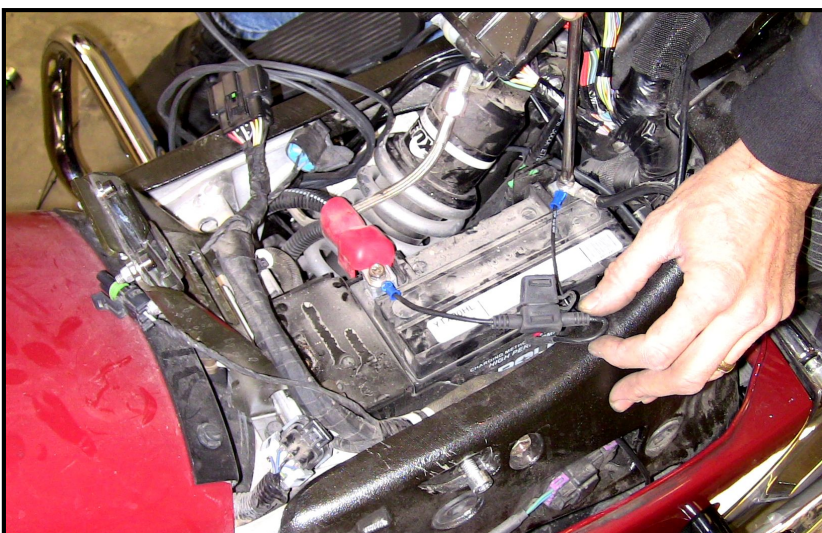

This wire should be run around the front of the shock to avoid the springs. The single wire with the fuse holder gets attached to the positive terminal of the battery, the other to the negative. Remove the fuse for safety before connecting the positive wire.

Now we have to get switched power for the system!

Find the orange wire with the spade plug and the black wire with the hoop connector (**On later harnesses, the Black wire is eliminated**). The system draws very little amperage; we used a pink and blue wire from the line running to the rear fender. We don't care where you get your 12 Volt source as long as it is switched and stays on while the bike is running. This wire works great, but stays hot until about 3 minutes after the bike is turned off.

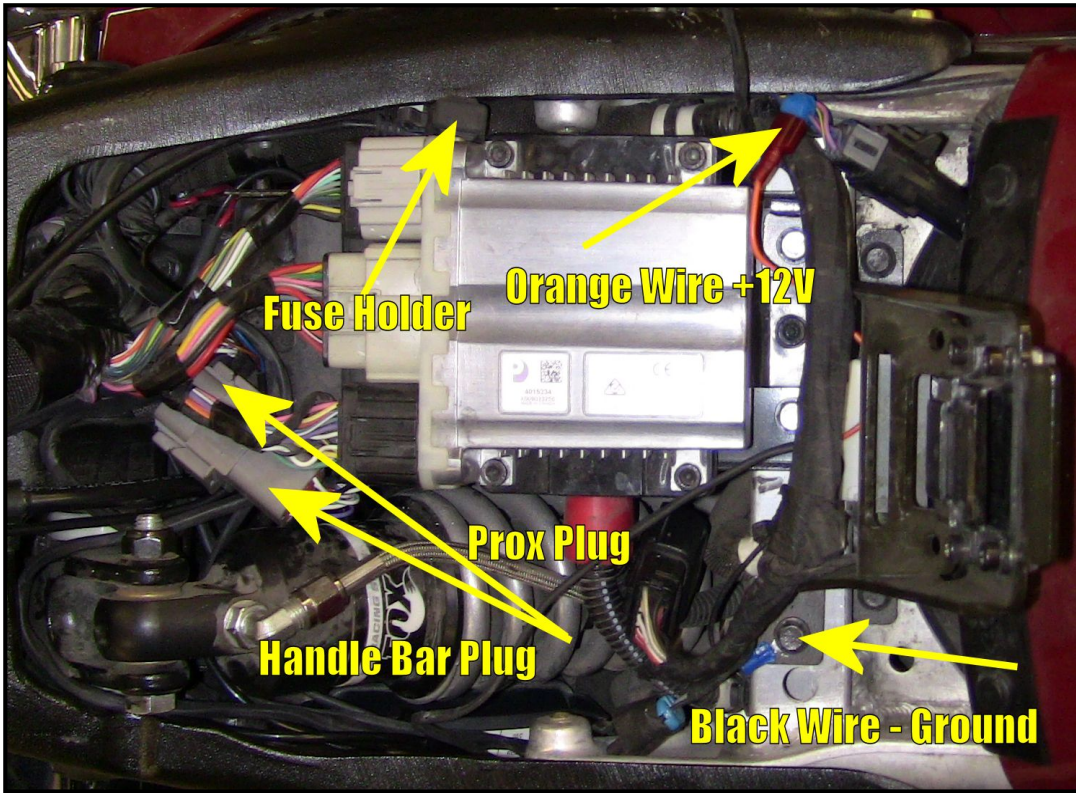

Find this wire, or whatever wire you choose to use (we had to strip back some tape) and attach the blue locking connector to it. The spade from the wire harness will mate to this plug as shown above.

We next need to ground the system.

Find the hoop connector on the black wire (If Present!) and run it to a mounting bolt like we did, and tighten the hoop under a good ground like this one.

We will duplicate this picture later, but you may wish to note how we stored the wires and plugs. The 3-pin (proximity sensor) and 6 or 8-pin (Handlebar Control Box) plugs are connected here. Difficult to see is how we ran the wires to the handlebar plug around the top of the shock, and how the proximity sensor plug, the handlebar plug and the fuse holder are placed. What is most important is that these wires are safe from scuffing or moving parts (the shock spring in this case).

Let's mount the legs!

LEG & MOUNT ASSEMBLIES

Now we need to mount the Legs to the where the rear floorboards were mounted. If you haven't already done so, you need to remove the two bolts (not needed after removal) that hold the rear floorboards to the bike. We will be mounting the legs to the casting behind these boards.

We need to tighten and apply red Loctite to the bolts that hold these mounts before mounting anything to them.

Using a small screwdriver, pry the plastic cover that hides the bolt as shown. Using an 8MM Allen socket, remove the mounting bolt that holds the casting to the bike.



Apply red Loctite to the threads of the bolt and re-install it. Make sure the bolt is **VERY** tight. These boards will have a tendency to pivot on this bolt if it is not tightened properly. *We suggest that **ANNUALLY**, you remove the Leg system and re-tighten and lock these bolts as a preventative measure.*

We want to start by mounting the floorboard to the top of the leg mount. The nut on the front bolt is basically impossible to get to once the leg is installed. Find the correct floorboard, (they are tapered toward the back) and mount it to the holes on the top of the leg. The front bolt is a 5/16"-18 X 1.25" Allen bolt. Run that bolt through the forward hole and get the Nylock started.

Here we ran the back bolt (which is 1.50" long!) through the rear mount hole just to line the floorboard up. Do NOT tighten the front nut all the way yet!

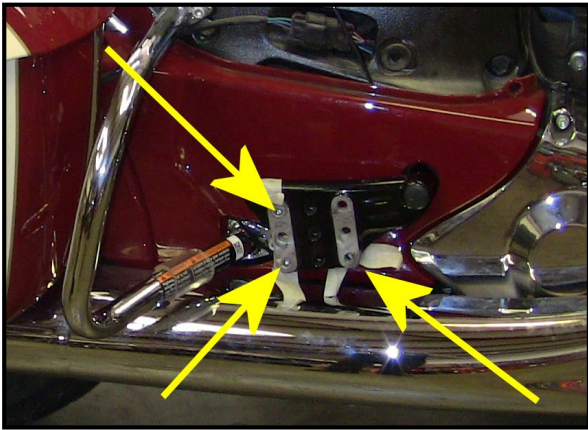

At left is a picture of the floorboard mounts with the boards removed (right side). The arrow shows the holes we will mount the legs with. To simplify the installation, find (4) 5-16" Lock-nuts, insert them into the castings behind these holes, and use masking tape to hold the nuts in place during the mounting process.

The rear bolts, as well as the rear bolt for the floorboard are Allen Bolts, while the lower front bolt is a hex head (to ease tightening). We suggest you get the

rear top bolt started first to help support the leg, then the rear bottom bolt.

Once you get the 2 rear bolts (1.25" long) and the rear floorboard bolt (1.5" long) started, we suggest you pull the leg down against the spring, and insert an Allen wrench or screw driver through the holes under the big chrome acorn nut that line up when the leg is extended (arrow below, we use a pin). This makes it easier to tighten the leg mounting bolts and to install the front-most bottom hex bolt.

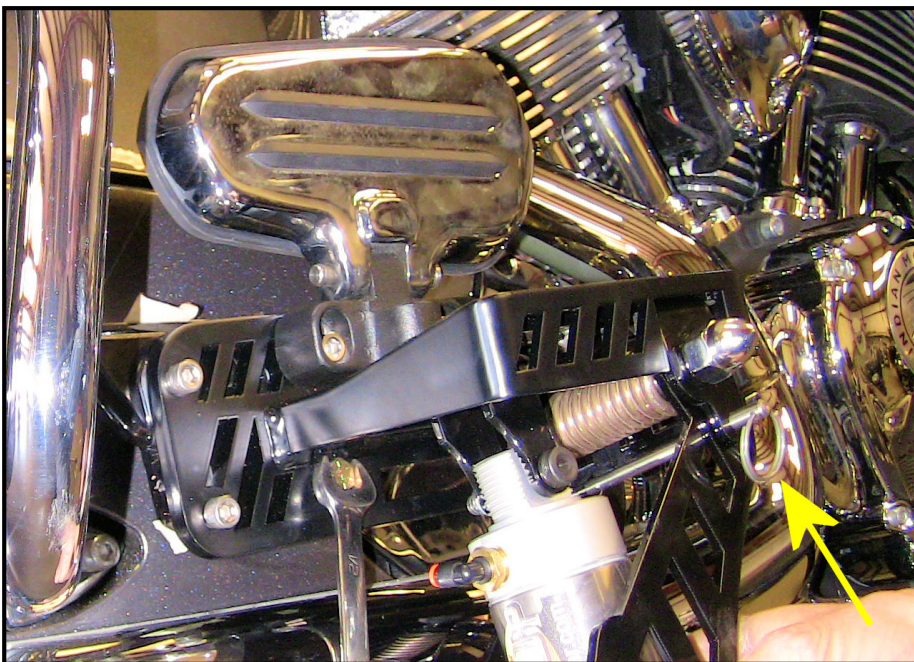
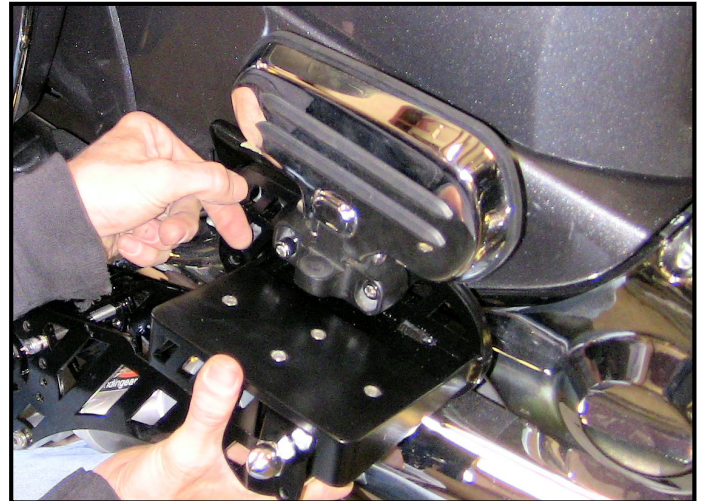

Tighten all 3 bolts a bit at a time using a long Allen for the rear bolts and an open end wrench for the bottom front bolt (left). It is easier, once the lower bolt is started, to tighten the rear bolts and the rear floorboard bolt, then remove the pin holding the leg down, and tighten the bottom bolt.

Lastly tighten the floorboard bolts. The front requires an Allen wrench and an open end 1/2" wrench, while the rear just the Allen wrench. Check the

floorboard and make sure it is tight! Once the floorboard is tight, it should be able to be raised and lowered without binding. Don't forget to remove the masking tape!

Repeat this entire process on the other side of the bike. Now, let's prepare the saddlebag!

MOUNT BRACE (OPTIONAL)

Chopper Design has developed a rear mount brace to help keep the mount from pivoting on the single mount bolt that holds the floorboard mount to the bike. **PLEASE NOTE:** This brace only fits bikes with rear crash bars!



In order to install this, the rear mount bolts go through the mount shown at left.

Make sure the slots face to the rear and clear the exhaust heat shield.

Find (2) 3/8" X 1" Allen bolts, (2) lock washers and (2) nuts. Also locate the rear portion of the mount brace.

Place the rear mount piece behind the front mount and locate it around the rear crash bar. As seen here. We suggest you insert the lower bolt through the two mounts, then the lock washer and start the nut. We would then just snug the lower bolt and then install the upper bolt.

What we want here is to get the rear mount as tight against the crash bar as you can and get the bolts very tight.

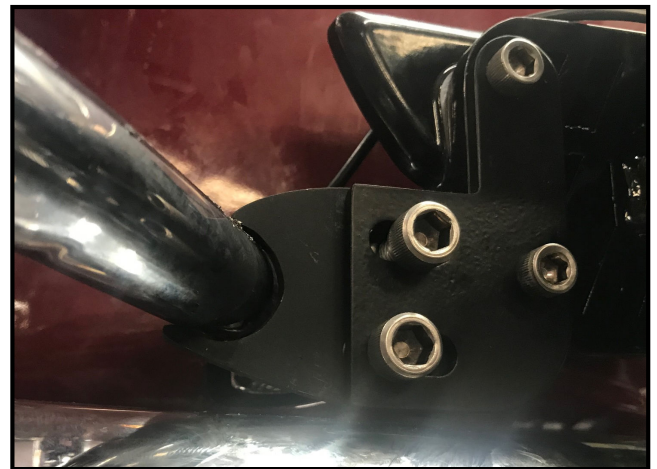

The mount works by offering resistance against the floorboard bracket twisting on its mount bolt. The bottom of the rear mount will NOT allow the back of the whole assembly moving up, and ultimately keep the entire part less likely to loosen over time.



Notice that the airline (covered later in this manual) lies on top of this mount, rather than through the center bolt hole (hidden by this new mount). We ultimately tie it gently, putting a wire tie through the top slot of the brace just installed.

Repeat this on the other side, now on to the Saddlebag Prep!

SADDLEBAG PREP

On one of the last pages of this manual, you will find a drilling template for left saddlebag. There are two different ones. One for the rounded bags, seen here, and another for the square bags (later models) seen on next page. Carefully cut the template out (making sure it is to scale), and tape it to the inside of the left saddlebag as shown. The bottom left edge lines up with the bottom square as shown here. Tape the guide down. There is a margin of error here, so don't worry too much about placement!

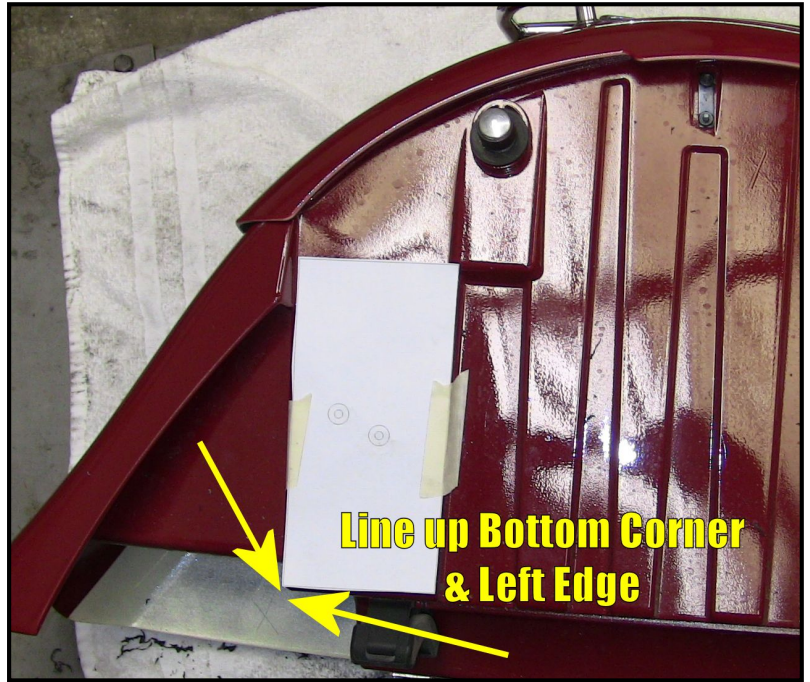

Use a small bit to start (1/8" or so) and drill through the pilot hole on the template. Once these are done, the final drill size is 1/2".

Once the holes are in place, find the bulkhead fittings. The 90 degree part stays on the outside of the bag with the straight part inside.

Start with the lower hole, and tighten the fitting. You will need a wrench inside and another outside to accomplish this. No reason to make it too tight, there is no chance for leaks here, and the elbow spins to make it easier to attach the lines.



Once the bottom fitting is in place, install and tighten the top fitting. Now the bag is ready!

If you have the square bags, picture is on next page, otherwise... Let's run the air lines!

Below is a picture of the square style bags with the template attached. If the template does not print to scale, use the measurements from the bottom left to mark the holes and drill as previously described. The Template is at the end of this manual.



RUNNING AIR LINES

We need to route the air lines to the cylinders; this way we can protect the excess, and ultimately pull them into the left saddlebag.

Let's start by attaching an airline to the right cylinder. Pull the leg down against the spring and press the end of the line into the fitting on the cylinder. Give it a tug to make sure it is connected well! We run the line under the mount, under the side cover where the bottom of the rear crash bar goes through the cover, and up to where Ben's finger shows us. You can remove the right bag and the sides cover if you find it easier. A wire-tie to the bottom of the mount to keep the line away from the pipe is a good idea here!

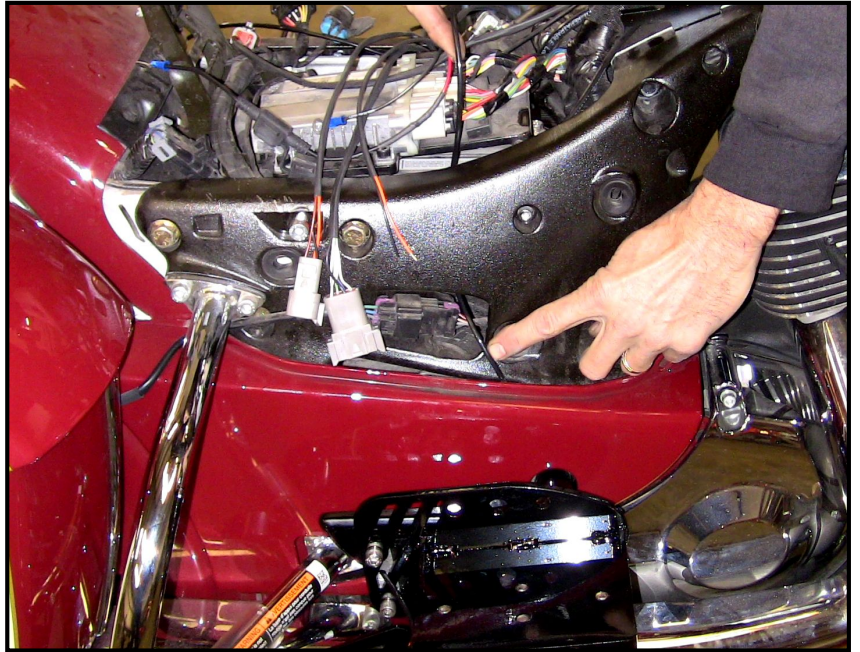

Guide that line in then run under the frame casting, up around the front of the battery and the shock and leave it wild as it will be joined with the other line soon.

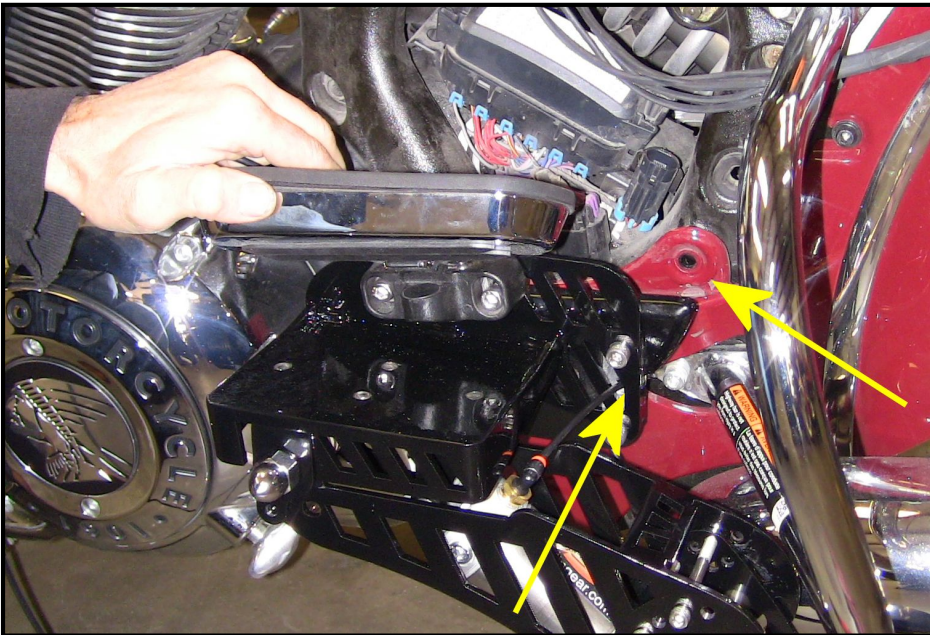

On the left side, we need to remove the two top bolts in the side cover and loosen the lower bolt. We need this loose to make sure the line can get where it needs to without binding. Once this is done, attach the line to the cylinder, run it under the mount and under the side cover where the crash bar mount attaches to the bike.

Run this line forward around the front of the fuse box and then join it with the other line and tie them both (loosely for now!) along the wires attached to the fender rail (Picture next page)

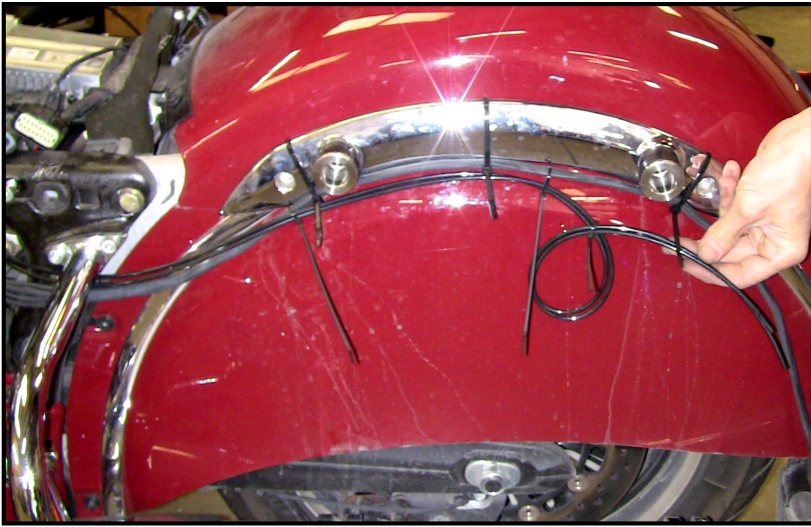

Notice the loop in the air lines shown here. We need about this amount of line in order to have the ability to remove and re-install the bags.

Next we want to test fit the saddlebag. Bring the saddlebag up to the bike, leaning away as shown below.

We need to make sure you have enough airline to make installing and removing of the bag relatively easy. You can pull extra line from under the seat if need be,

or pull excess back from the fender strut if needed. There is no real trick to how to run these lines, just make sure they are not in a bind or in danger of getting hot or crushed! Install the lines into the fittings and attach the saddlebag.

If the line length is the way you like it, remove the lines from the fittings (press the plastic ring down then pull the line out) and take the bag off.

Tighten all the wire ties so the airlines stay where you want them to say. Pull back all the extra line under the seat area and make sure it is safe and secure. Remember; these are airlines. No hard bends or crimps please!

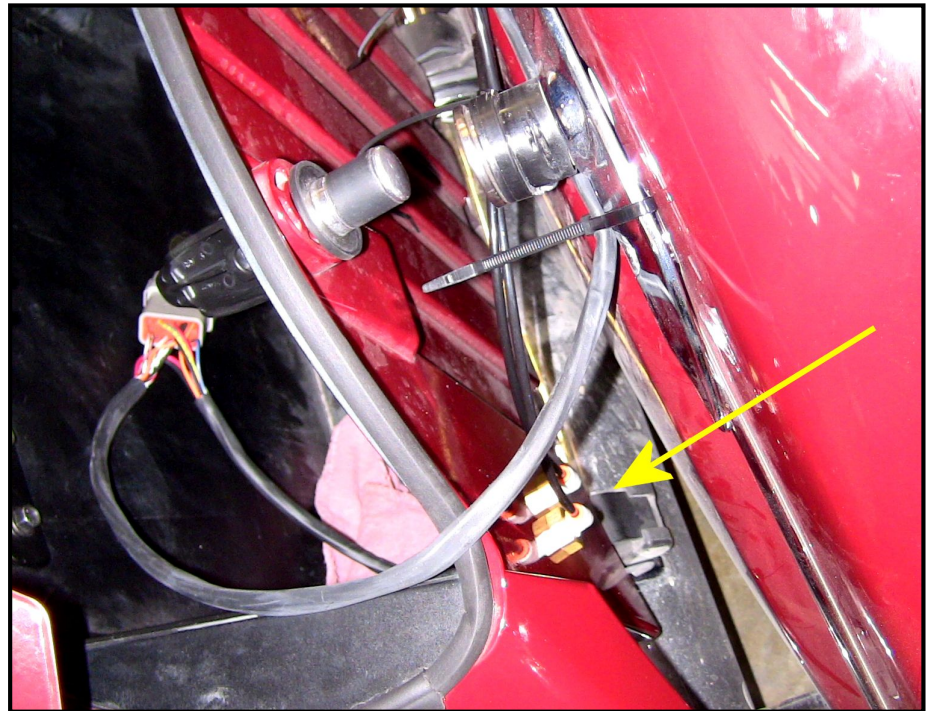

You should manually run the legs up and down against the spring and make sure you have enough slack for this to occur. Assuming everything is how it should be, let's install the compressor!

INSTALL THE COMPRESSOR

Find the compressor, as shown here. As you can see, we expect the left saddlebag to be mounted with the lines as we showed you in the previous section.

We want to attach the two lines from the valve on the compressor plate to the fittings we mounted in the left saddlebag. Make sure the connections click into place

We also want to attach the 12-pin plug from the harness to its mate on the computer, and attach the 8-pin plug to the plug attached to the compressor. These plugs only connect one way.

Next we want to slide the compressor system into the saddlebag (below left). Notice that under the plate the compressor sits on is an air tank mounted with rubber straps. This tank falls into the hollow toward the outside of the saddlebag, while the rubber acts as an insulator/vibration dampener.

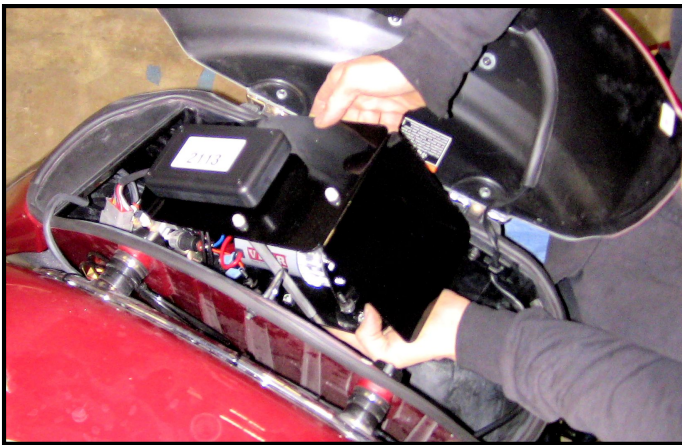
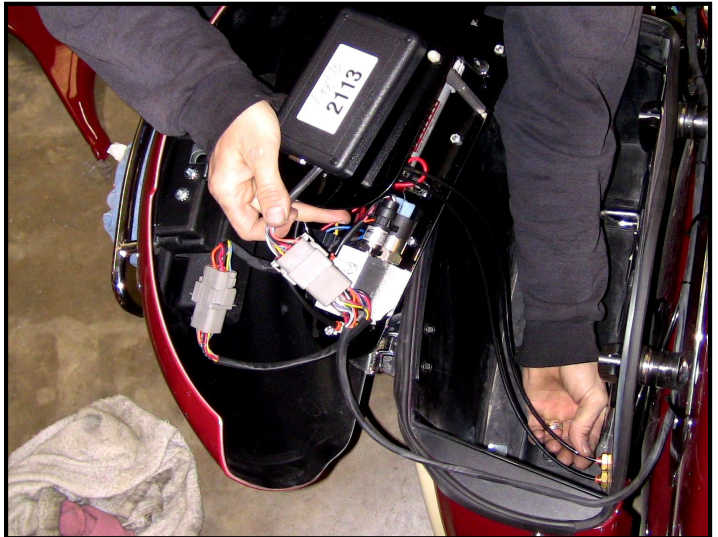

the back of the bike and land under the compressor top cover. Drop the entire system down and move it as far back as it can go. The fitting on the air tank will stop you from pushing back too far.

The system should fit well on its rubber feet and be stable. The edges of the mount and the top should be clear of the bag. The wires and hoses should be basically invisible.

Tilt the compressor system back as shown here, making sure the two plugs are moved toward

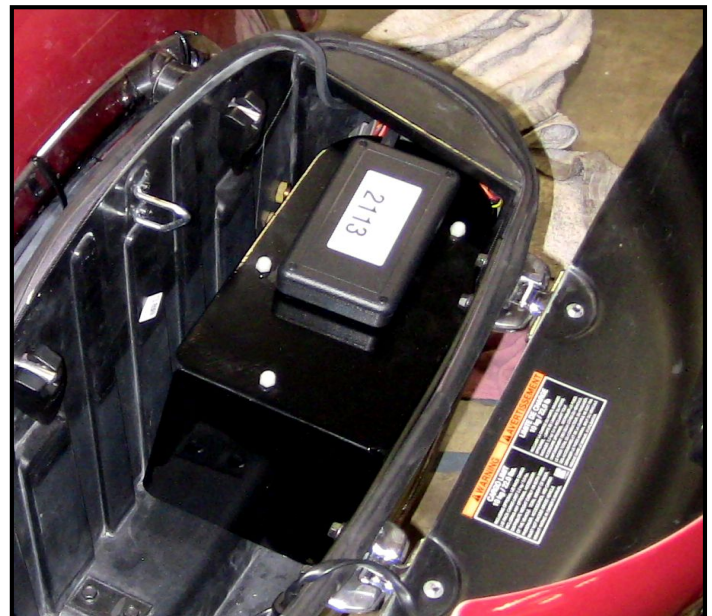

When complete, it should look like the picture here. Let's test the system!

INITIAL SYSTEM TEST

Turn your key switch on. If everything is working properly, the compressor should turn on for about 6 seconds to fill the onboard air tank. At this point, have a look at the yellow proximity sensor.

PLEASE NOTE: Immediately after turning on your bike (within 5 seconds), the top light on the handlebar control will flash for a few seconds. This is the system either making sure that no air is in the legs if they are up (for safety it makes sure air does not build up when the legs are in the up position), or that the proper amount of air is in the system if they are down (again for safety to make sure the legs stay pumped completely!). This test occurs once a minute for all the time the bike is powered up, whether you turn the LegUp system on or not!

The **RED LED** (ON The Sensor) ***Should Not Be Lit***. Take a metal object (screwdriver, wrench, etc.) and hold it on the flat face of the sensor (it has a circle embossed in it). The LED should light up, and go out when you move the metal away. If not, check all your connections.



Next, press the rightmost pushbutton on the handlebar switchbox, and hold it for at least 3 seconds. Both LEDs on the switch panel should light up; green means the legs are up and yellow means the bike is traveling under 6MPH. If this occurs, you are doing well.

The next step requires some care. If the bike is still on the lift, have a helper hang on to it as you touch the left button for just a split second. The legs should move down, likely until the wheels hit or miss the lift, and they do this **VERY** quickly! The compressor will likely start and run for about 10 seconds. Press the left button again and they should move up.

If all of the above has occurred, great! Turn the ignition switch off, the test is complete!

Let's move on to mounting the Proximity Sensor.

MOUNT PROXIMITY SWITCH

This step is crucial!! Understand it before starting. The proximity sensor tells the system how fast the bike is traveling. The proximity sensor mounts to the lower right leg. The sensor will ultimately be mounted 5MM from the rotor bolts.

The proximity bracket is a thin black bent piece of metal with the yellow plastic sensor and long black wire attached.

Remove the lower fender trim bolt on the front of the right fork leg. With a bit of blue Loctite on the bolt, insert it through the proximity mount bracket and back into its mounting hole. **(NOTE: If the bolt is too short, one of the floorboard mounting bolts you removed earlier can be used as it is ¼" longer)** Tighten this bolt with the bracket placed as shown in the picture below.



It would be very helpful if you can jack the front wheel off the ground or lift for this operation, otherwise you will need to roll the bike to test the sensor. The idea here is to have the yellow proximity bracket line up with the rotor bolts and be placed no more than 5MM away from them as they rotate!



Turn the ignition switch to the on position. The LED may or may not be on. What we are looking for here is for the LED to light as a rotor bolt passes close to the sensor and to go out as the bolt passes by. Have someone watch the LED as you roll the wheel, or the bike, back and forth making the bolts pass close to the sensor.

Once you feel you have the right place, tighten the cap nut down securely, and test again!

If this is not happening, you may need to get the sensor a bit closer to the bolts (5MM is a very small distance!). If you have to move the sensor closer, you may have to bend or adjust the angle of the bracket.

No matter what you need to do, you **MUST** make sure that as the wheel turns, the light works as described above! The automatic retraction of the legs as well as their deployment **RELIES** on this sensor being placed perfectly!

Once satisfied with the mount, make sure the wire is tied off properly to the brake line and can't get caught or touch anything that could hurt the wire. Next, remount the chrome brake caliper cover. Now we can skip down to the wire routing instructions below.

WIRE ROUTING

The wires from the proximity sensor should already be routed and tied to along the front brake line and met up with the handlebar switch wires. This would be the time to make sure the handlebar wires are tied nicely to the handlebar.

The trick here is to make sure that these two wires don't bind or get caught on anything as the front forks are turned from lock-to-lock.

Under the seat, pull any extra slack from these two wires back to the under the seat area.

Now would be the time to verify that the wires in this area are clear of anything dangerous that could damage the wires or hoses.

Below is a picture of this area; make sure your installation look similar. Use wire ties to

make sure that all wires and air lines will stay where you put them and that they will not come in contact with anything that moves.

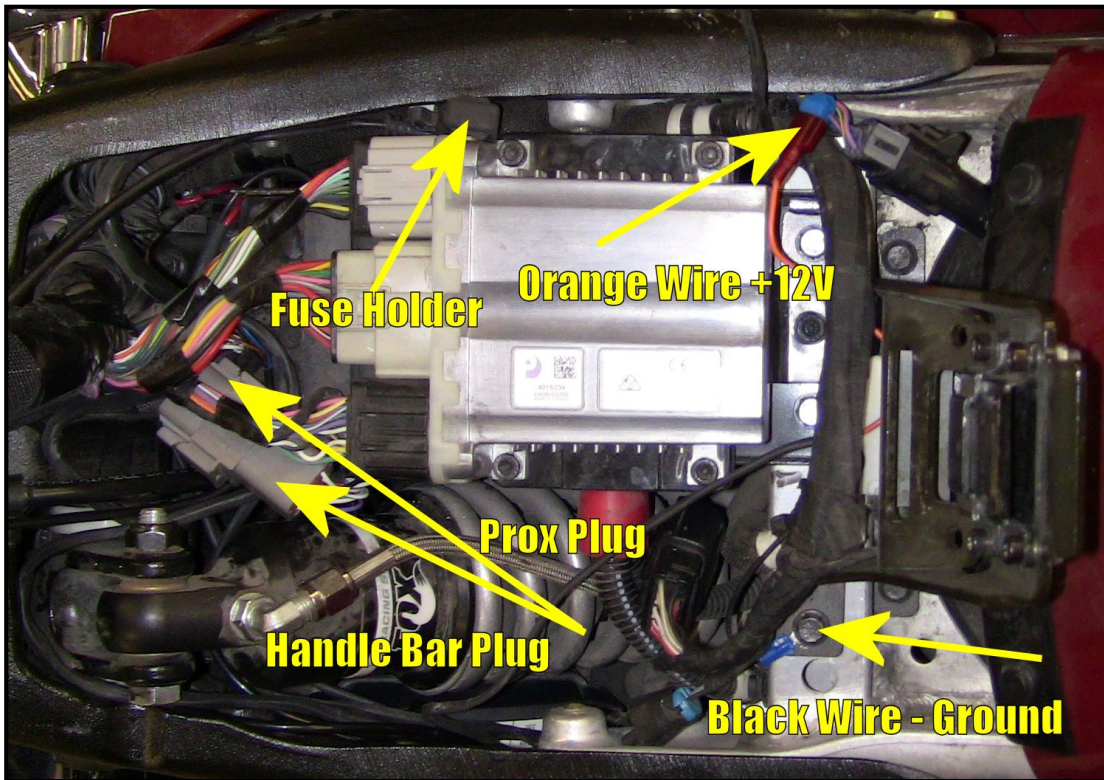

FINISHING UP

Now it is time to reinstall everything you took off, and do final checking of everything! Side covers go back on making sure the wires are neatly stored, and the air lines are not in any sort of bind! Reinstall the seat making sure all your wires are routed neatly, tied off nicely and don't interfere with the seat installation.

Once all of this is accomplished, we should get the bike on the ground, and with a helper, cycle the wheels up and down manually a few times, having your helper make sure the air lines are not being scuffed or are over tight, and that the lines are out of the way of anything that could damage them (*NOTE: The Legs have a tendency not to come all the way up during this test... no worries; once we apply power and let the air out, they will come all the way up!*). Double-check all your bolts for tightness. Now we can dial in the legs, and adjust the wheels if needed.

LEAKS!

This system uses air, and air loves to leak! The fittings we use are tested for leaks before shipping, but we have a few simple tests to make sure you have no leaks or just insignificant ones if any.

Set the wheels down and leave the system on. Put the kickstand down, and turn the bars all the way left.

If the compressor makes noise more than once every two minutes, you may have a leak at the lines that connect to the compressor or the tank fittings. Some soapy water will tell you where (you will need to remove the compressor top to test for these leaks).

Assuming the compressor doesn't lose enough air to kick on after 2 minutes, you should be fine.

You can turn the bike off, and wait to see if in 5 minutes the bike is not as stable as it was when the wheels were first lowered. If it lasts the 5 minutes and is still very stable, you could still have a leak, but not one that would be a problem on the road!

Leave the bike on its wheels overnight (again kickstand down, bars full left in case the legs lose a lot of air; the bike will land on its stand). If in the morning, the bike is still stable you have no leaks.

If there are leaks, the fittings on the air cylinders would be the first for the soapy water check, with the two small line fittings on the compressor next! If you need help with these, please feel free to call us at (407) 834-5007.

FINAL ADJUSTMENTS & MAINTENANCE MODE

The next two sections are typically **NOT** needed. We include them to document your system thoroughly, but **MOST** people will never need to use either section.

MAINTENANCE MODE

NOTE: Maintenance mode is a procedure that ‘TEACHES’ the computer how much pressure to use when it lowers the wheels and how much pressure to release when raising the wheels. We always set this at the factory; ALWAYS!! We include this procedure in case it is ever needed in the future.

Please skip this section unless you have been instructed to reset the system by Chopper Design.

Turn the ignition to Accessory and start the LegUp System (hold right button for 3 seconds). The system should be set at the factory for proper pressure, but some wheel adjustment may be needed. If it has been determined that **‘Maintenance Mode’** is needed, Sit on the bike, and hold it level. If both lights on the switch box are flashing, the system is in maintenance mode. If not, **PRESS & HOLD** both buttons until all lights flash. ***(Do your best to press both buttons at the same time so the system doesn’t respond to what it thinks is a request to lower the legs)*** Once flashing, hit both buttons for an instant to get the system in the **‘DOWN’** setting mode (lower, yellow LED flashing). Touch the left button briefly; the wheels should go down immediately. ***(This is VERY quick, don’t be startled!)*** Using very short pushes of the left button, press and then feel the stability of the bike. If it feels firm enough, try leaning the bike a bit. If the wheels return the bike to upright, there is likely enough pressure. Put your feet on the floorboards; the bike should stand on its’ own. Rock the bike a bit left and right, being prepared to put your feet down. If the bike continues to come back to upright, the **DOWN** stop is now set and we can move on.

Hit both buttons for a moment to get into the **‘UP’** stop mode (Usually hitting the left button just before the right assures that air is not released!) The top LED should now be blinking. Press and hold the right button to raise the legs. Listen as the air evacuates; once it is quiet, let go of the right button. The **UP** stop is now set! Hit both buttons when complete, Both LEDs should light, and you are done with these adjustment.

Now press the left button and the legs should lower; again this is fast and loud. The bike should be held up firmly! Hit it again and the legs should retract. If you are satisfied with these limits, you have successfully installed the LegUp System.

WHEEL ADJUSTMENT

The LegUp GEN II system is typically set up at the factory for the height of your bike. The system is VERY height dependent! If after testing the initial installation, the bike does NOT feel stable, the wheel system MAY need to be adjusted to the height of your bike. AGAIN, we normally ask at order time if your bike is at stock height and we set the system up for whatever height you have furnished us. DO NOT make any changes unless the stability we expect is NOT present! If you feel you need to adjust the height/length of the wheel holders, please read this ENTIRE section before starting the process. If you need help, please contact Chopper Design at 407-834-5007.

If you are happy with how stable the bike feels, you can skip this section, and move on to a test ride! If you are not sure, or you skipped ***'maintenance mode'*** as instructed, a good test is to bring the wheels down, put the kickstand down, and lean (or try to) the bike on its kickstand while sitting on the bike. If the bike comes back to center without your help, or you put your feet on the boards and can bring the bike up by just leaning to the right; move on to the next section (Test Ride), the wheel settings are fine!

The stability of the GEN II LegUp system, relies on the pneumatic actuator, when deployed, being at an angle that is forward of perpendicular for best results! Different bikes are at different heights, and Chopper Design uses an ingenious method to adjust the length of the supporting legs to maximize the stability it affords.

Typically, we will send the 'Leg Assemblies' set up for perfectly for your bike. In the event your bike is at a different height than stock, the information and adjustments that follow may be required.

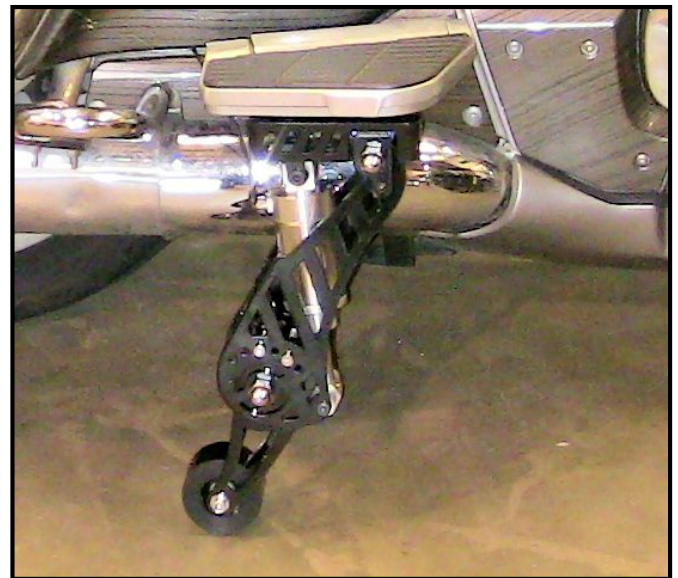

Below, we show you the wheel holders which should help clear up any confusion you may have about the wheel holders and their adjustments.

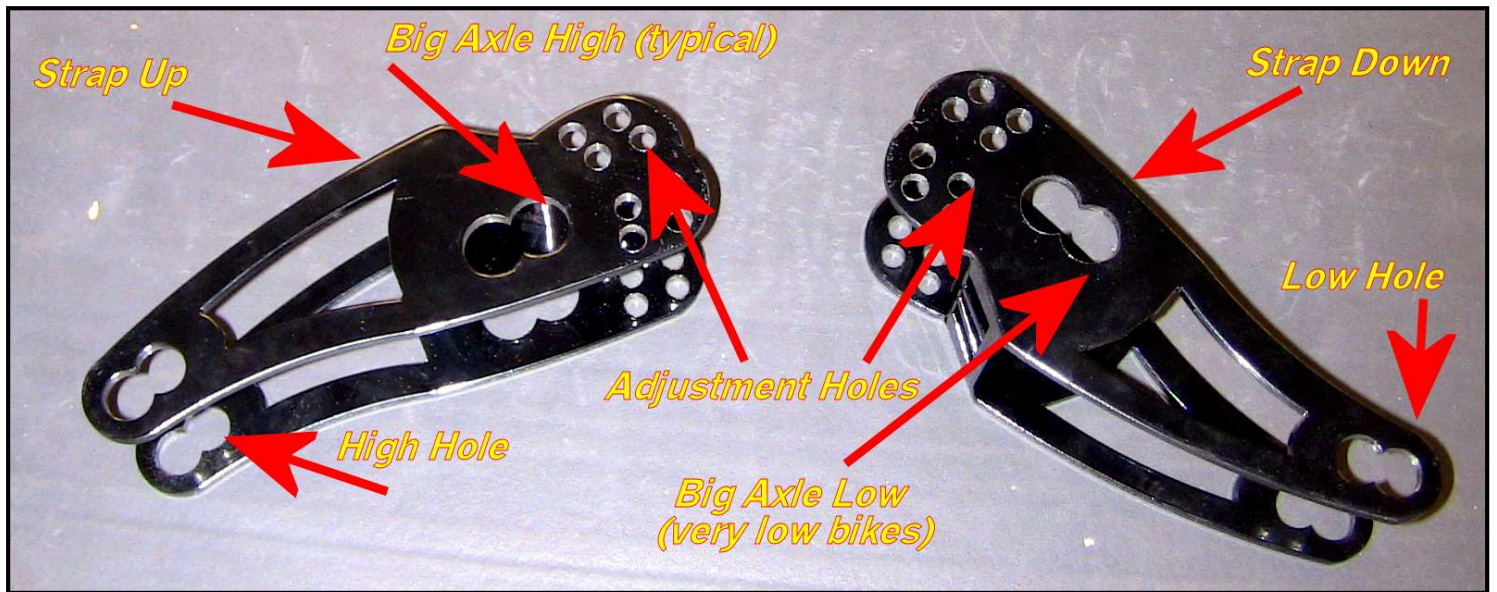

On each supporting leg, you should find two bolts down near the end, by the wheels. The two bolts control the angle of the ‘Wheel Holders’. By moving the wheel forward or back, we can tailor the length of the support arms to a particular bike.

A helper is handy here. Make sure the wheels are up. Make note of exactly which two holes the bolts are in. Loosen the locking nuts from the back and remove the bolts; you will notice the ‘Wheel Holder’ can pivot on the big axle bolt. Starting on

the left side of the bike, move the bolts one hole counter-clockwise. Go to the right side and move them one hole clockwise. Loosely fit the nuts (no need to final tighten them at this point).

Lower the legs. Is the bike more or less stable? If it is more stable, and you can sit on the bike and rock it back and forth without it leaning over you are done. If not, remove the bolts again, and move them in the opposite direction two holes, and retest. If everything is fine, final tighten the lock nuts and you are done.

If you need to, you can move the wheels from the lowest hole, up one hole. You can remove the wheel holders, turn them over (strap up instead of down for example) and install them on the other side of the bike. You can move the big axle from the low to the high hole. All these techniques take patience, but allow significant flexibility to tailor the system to your bike. On the next page we show you some examples. Normally you do not need to do **ANY** of these adjustments, but if you need to, we wanted to teach you the methods at your disposal.

TEST RIDE

PLEASE NOTE: Immediately after turning on your bike (within 5 seconds), the top light on the handlebar control will flash for a few seconds. This is the system either making sure that no air is in the legs if they are up (for safety it makes sure air does not build up when the legs are in the up position), or that the proper amount of air is in the system if they are down (again for safety to make sure the legs stay pumped completely!). This test occurs once a minute for all the time the bike is powered up, whether you turn the LegUp system on or not!

Get the bike to a clear paved mostly level area where you can test ride it. Start the bike, turn on the LegUp system and lower the legs. The first test should be done in a straight line. Put the bike in gear and slowly accelerate. You may notice that the bike tends to want to steer a small amount left or right. This is normal unless it is severe. Effectively, you are driving a trike, and steering is done with the handlebars **NOT** by leaning. Once underway, (we recommend you keep your thumb near the left button and press it to raise the wheels if there are any surprises) the top LED should flash at around 6 MPH, meaning the legs are retracting. It is difficult to lean on one wheel or the other as you leave, so you may wish to raise the wheels manually if the bike is steering due to uneven pavement.

Assuming the legs are retracted, you should try to deploy the wheels. As you come to a stop, the Green LED should be on. As you slow down (**almost stopped**), the Yellow LED should illuminate at the proper speed. Once it does (sometimes hard to see), hit the left button and put your feet down near the ground. The top LED should flash and the wheels should deploy almost instantly underneath you! Make sure you are ready to balance the bike, though you likely won't have to! Immediately after the wheels touch the ground, the bike should be supported reasonably, but the cylinders can take up to 6 seconds to get completely filled. Make sure you balance the bike as this occurs. The slower you are going when deploying the wheels, the smoother the transition will be from wheels up to wheels down. Practice these maneuvers until you are comfortable with the wheel adjustments and the system operation.

NOTE: With the system on or off, if the legs are up, the computer will dump the air from legs once every minute that the bike is turned on! This is a safety feature to make sure pressure does not build inside the legs, causing them to deploy! The top light will flash once a minute for a few seconds. This is completely normal, and the left button will be inoperable while this occurs.

SEMI-AUTOMATIC DEPLOYMENT: Another way to deploy the legs is semi-automatically. First we must be **SURE** that the proximity sensor is working properly or the wheels could come down at higher speeds than we wish. If you are travelling at a speed over 10 MPH, AND the yellow light (bottom) on the handlebar control is out, hit the left button. The bottom or yellow LED should start to flash. When you slow down to around 5MPH the wheels will deploy (see the red/green flash on top LED). Again prepare to put your feet down. IF the lower LED is lit at a speed over 10 MPH, don't hit that button; see caution below!

NOTE: The bottom LED Should not be LIT SOLID if the bike is travelling over 10MPH! In the event it is, the wheels will deploy instantly if you try to set them as above; this is dangerous! You MUST re-visit the sections on testing the proximity sensor. You should always be aware that this light should NOT be on if you are traveling at speed, and 'Arming' the system for deployment should only be attempted if the lower LED is Not Lit! Please see the User Manual for more information on Proximity Sensor Failure!

The next thing to try is to make a turn from a dead stop with the wheels down. As soon as you start the bike moving, turns can only be made by using the handlebars. The LegUp system is too strong to allow a great deal of lean with the wheels down! If you need to make a turn shortly after departing from a stop, raise the wheels manually (left button) and you will get complete control again.

The next thing to try is slow speed maneuvering with the wheels lowered. If you keep your speed down, most slow speed maneuvers can be accomplished with your feet up, keeping in mind that at about 6 MPH the wheels will come up automatically! You can try full lock turns in both directions and the bike should stay upright with your feet up.

Understand; it is always a good idea to keep your feet near the ground during these maneuvers if you can. A mechanical failure or a wheel in a pothole could upset the bike.

Because the wheels are right behind your legs when they are down, we recommend not trying to push with your feet to move the bike forward. Use the engine and keep your feet out of the way; this way the legs don't bite at your heels as the floorboard always have! Backing up using your feet works fine and the chore of balancing the bike is taken care of for you.

Practice, practice, practice!! Enjoy your LegUp System!

ILLUSTRATIONS

SADDLEBAG DRILL TEMPLATE

Print and Cut out Make Sure Dimension is Correct!

Some printers don't print to scale!!

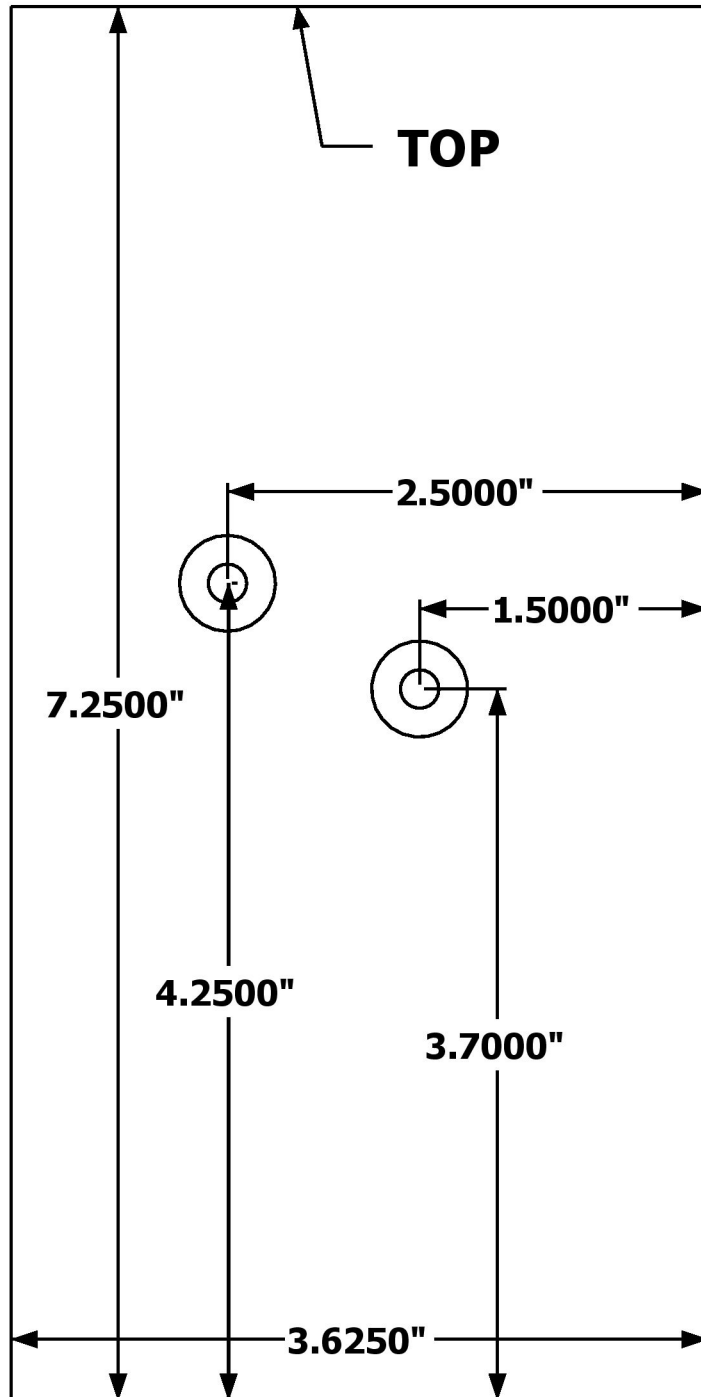

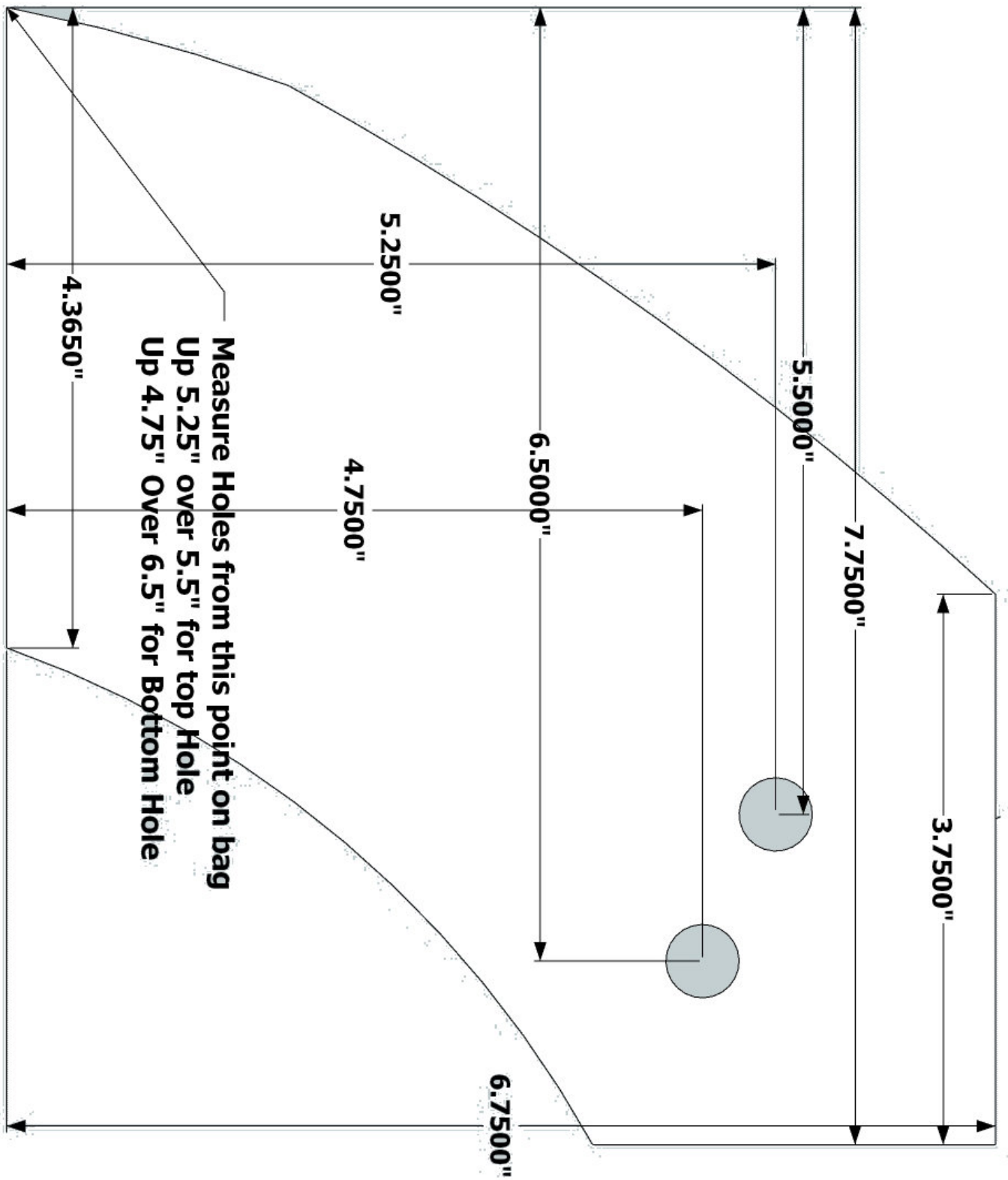

This Template is for Square (Late Model) Bags It is likely NOT to Scale. Use Measurements to get the Holes Close!!

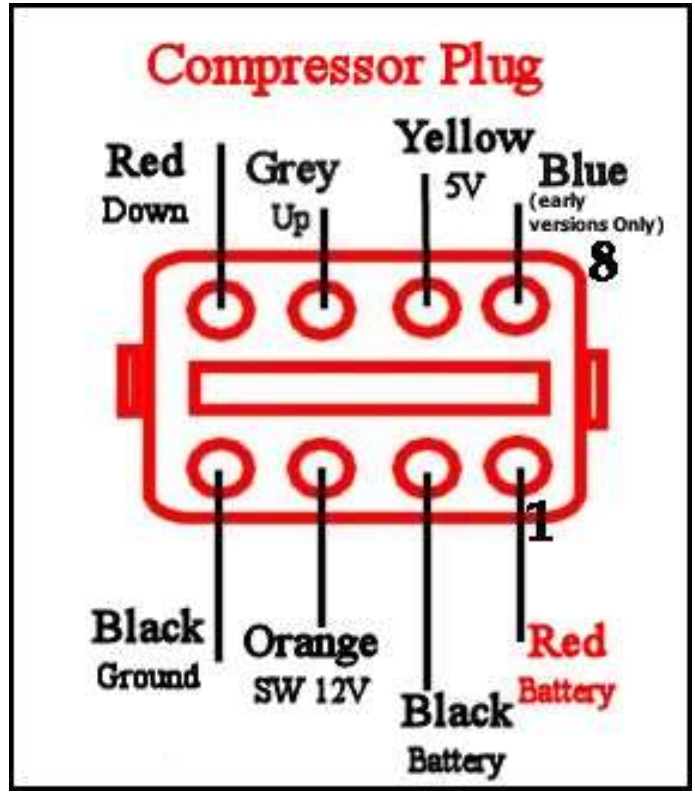
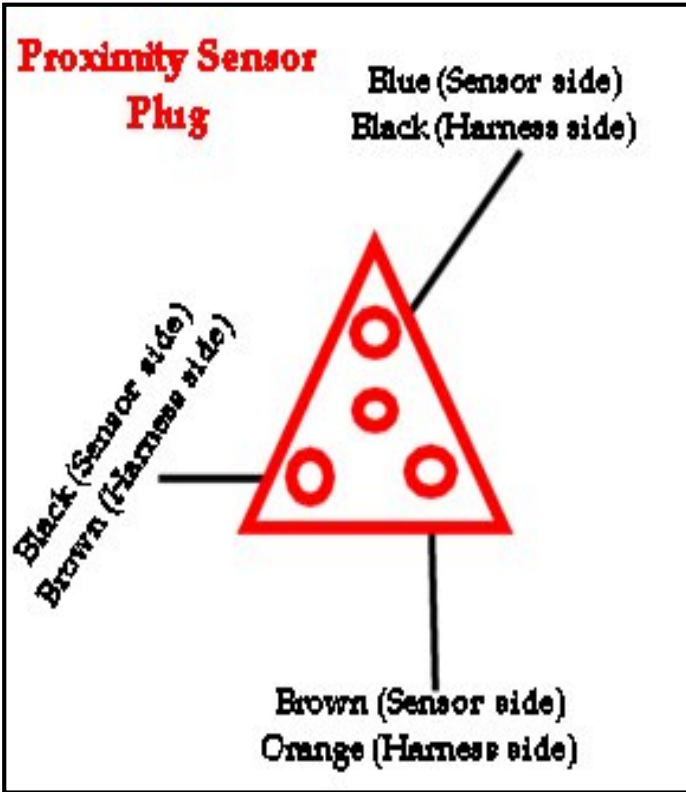

Due to global distributions problems, we may have to use a four pin plug instead of a 3 pin plug. The colors still need to be the same across the plugs with pin 4 empty!

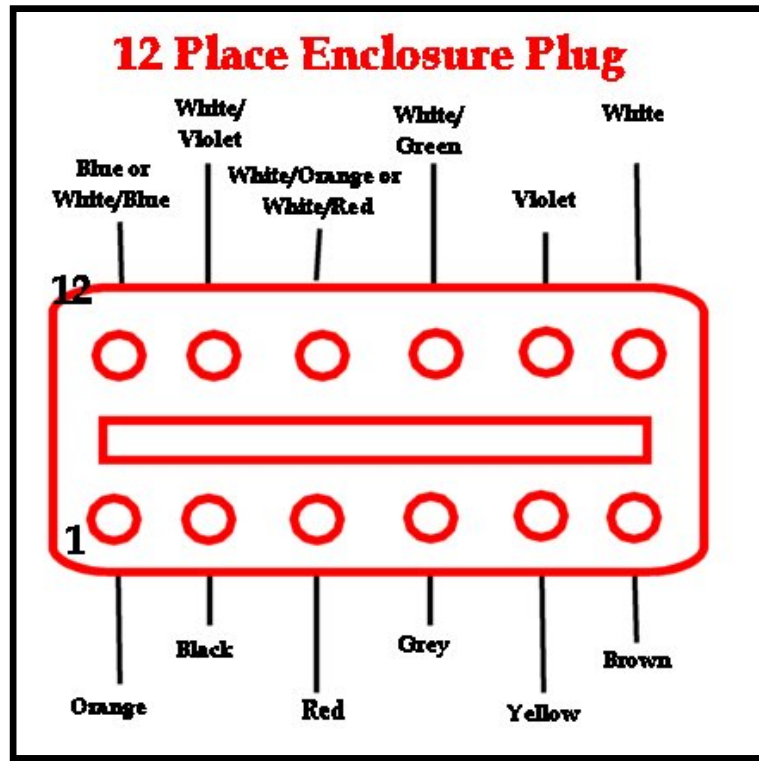

PARTS LIST

- (4) 5/16 - 18 X 1.25" Allens with Nylock (Leg Mount Rear Top & Bottom)
- (2) 5/16 - 18 X 1.25" Allens with Nylock (Front Floorboard to Bracket)
- (2) 5/16 - 18 X 1.50" Allens with Nylock (Rear Floorboard to Bracket & Mount)
- (2) 5/16 - 18 X 1.25" Hex Bolts with Nylock (Leg Mounts Bottom Bolts)

- (2) M6 X 40MM Allen Heads with washers (Switch Housing)
- (2) 3/4" Spacers (3/4 X .25ID X .35OD for Switch Housing)
- (1) 10-32 X 1.25 Allen for Switch Box

- (2) Bulkhead Fittings (Saddlebag)
- (2) 7' Air Lines (Legs to Saddlebag)
- (2) 2' Air Lines (Compressor to Saddlebag)

Wire ties, extra air line. Remove 6-Pin Plug on HB Harness, Remove 3-Pin Plug for Speed Sensor, Use Male Spade on Orange wire, Hoop on Black and Wiretap Adapter, Include Clear Rubber for Crash Bar, Use 5 Bolt Program.