



US PATENT # 8,235,419 B

Installation Manual

Generation II - GL-1800

2001-UP

**Copyright 2016, Pete Giarrusso, Inc.
D/B/A Chopper Design Services
All Rights Reserved**

Table of Contents

INTRODUCTION	4
WARRANTY	5
INSTALLATION INSTRUCTIONS	6
1) <i>Wire Harness W Switch Box.....</i>	<i>6</i>
2) <i>Leg and Mount Assembly (L/R).....</i>	<i>6</i>
3) <i>On-board Computer Module.....</i>	<i>6</i>
4) <i>Proximity Sensor.....</i>	<i>6</i>
5) <i>Saddlebag Mounted Compressor System with Tank.....</i>	<i>6</i>
6) <i>Hardware Bag.....</i>	<i>6</i>
PREPARE FOR INSTALLATION	7
CONTROL SWITCH BOX	8
WIRING HARNESS	11
RUNNING AIR LINES	15
SADDLEBAG PREP	17
INSTALL THE COMPRESSOR.....	18
INITIAL SYSTEM TEST	20
MOUNT PROXIMITY SENSOR.....	21
WIRE ROUTING	22
FINISHING UP.....	23
<i>FINAL ADJUSTMENTS & MAINTENANCE MODE.....</i>	<i>24</i>
<i>MAINTENANCE MODE</i>	<i>24</i>
<i>WHEEL ADJUSTMENT.....</i>	<i>25</i>
TEST RIDE	27
GENERATION I UPGRADE INSTRUCTIONS	29
ILLUSTRATIONS	30

Introduction

This manual covers installation of the Generation II LegUp LandinGear system by Chopper Design Services. This system should only be installed by a qualified technician, or those with above average mechanical skills. If you are not **SURE** that you can perform this installation, please contact us and we will help you find a qualified shop to assist you.

While the Generation II System holds your bike upright very well, you are **STILL** responsible for balancing the bike! The system **WILL** relieve you of some of the weight of the bike and help you avoid balance problems as you approach a stop, maneuver at slow speeds, and back the bike up.

Improper installation will void your warranty, so please be very careful!

Thanks for choosing LegUp!

Warranty

Chopper Design Services warrants the LegUp system for a period of one year from date of purchase. This warranty covers replacement parts and/or manufacturer defects. Incidental damages or costs are the responsibility of the purchaser.

Defective parts are to be returned to Chopper Design at the address below. Purchaser must contact Chopper Design to receive a Return Material Authorization, prior to returning defective parts to Chopper Design.

Abuse, improper installation or use, collisions or accidents, are not covered under this warranty. Replacement parts for this type of damage are available through Chopper Design.

Users of the LegUp system agree that Chopper Design is NOT responsible for personal injuries or damage to property arising from the use of the system. While we believe this system to be safe and reliable, the user is advised that use of LegUp is done so at the users' own risk. Use of the system implies agreement to the above statements. If you can't agree with the above, Chopper Design and its dealers would be happy to refund your full purchase price, before you use the LegUp System.

Chopper Design Services
1365 Bennett Dr. #101
Longwood, FL 32750

407-834-5007
LegUp@LandinGear.com

Installation Instructions

The LegUp® system has many components. Please be sure you have them all before starting your installation.

COMPONENTS:

- 1) **Wire Harness W Switch Box**
- 2) **Leg and Mount Assembly (L/R)**
- 3) **On-board Computer Module**
- 4) **Proximity Sensor**
- 5) **Saddlebag Mounted Compressor System with Tank**
- 6) **Hardware Bag**

If you believe you are missing any parts, please contact Chopper Design at 407-834-5007, and we will rectify the situation. Some of the parts are shown below.

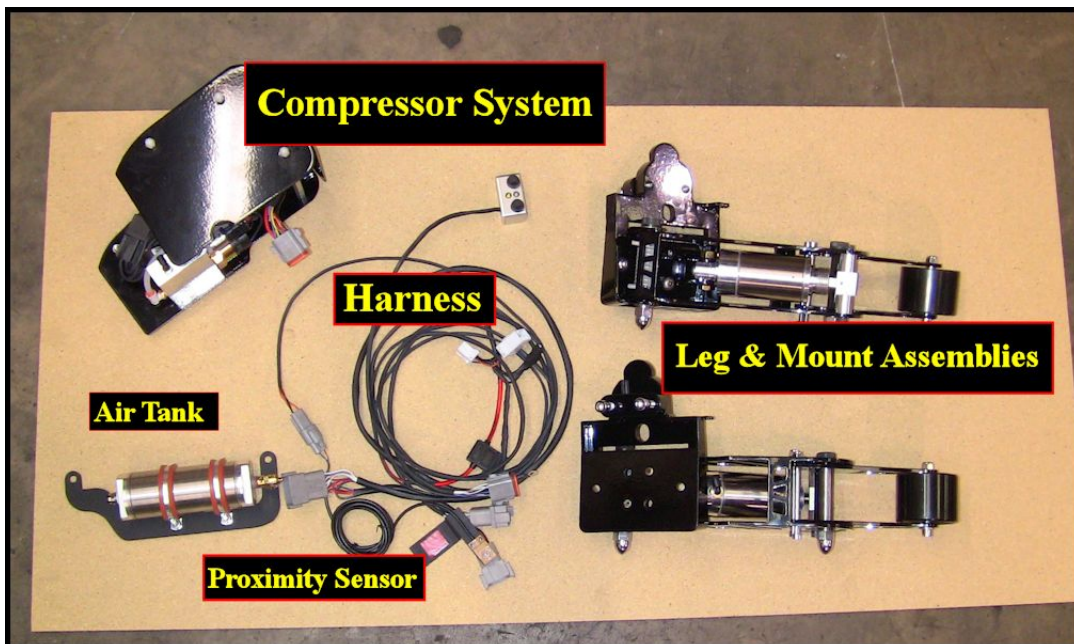

PREPARE FOR INSTALLATION

IF YOU ARE UPGRADING FROM A GENERATION I SYSTEM, PLEASE READ THE ADDENDUM TOWARD THE END OF THIS MANUAL ON THIS SUBJECT FIRST!

Place the motorcycle on an acceptable bike lift. You will need to keep the bike on its wheels for most of the installation, and jack the rear wheel off the lift for some portion of the installation. Make SURE the motorcycle is secure on the lift!

Remove the seat and both passenger floorboards; they are not needed until the very end of the installation. The Center Stand **MUST** be removed as it will be impossible to access once the wheels are installed (***Right nut is reverse thread!***).

This manual is available at <http://landinggear.com/pdf/g2installgl1800.pdf> . It may be easier to see some of the pictures in color there!

This system will fit the 'F6B' Model 1800s as long as GL1800 Floorboards are mounted in place of the rear foot pegs. Some things during the installation will be slightly different, but installation on this model can be done.

The GL1800 has many covers and pieces that need to be removed and/or reinstalled during this installation (like the center stand). While we have worked diligently to make this manual very thorough for the installation of your new LegUp system, we DO NOT cover all of the details on how to remove and reinstall some of these parts. Please consult a service manual or a qualified technician to help with these item if required!

We are now ready to begin!

CONTROL SWITCH BOX

The switch box should already be mounted to a black mounting plate. The switch box mounts under the left grip and attaches to the left switch housing by a single bolt. Remove the bolt from underneath the left switch housing using a Phillips screwdriver.



Using the bolt provided, slip the bolt through the black plate and spacer, and then thread it into the switch housing. This bolt needs to be snug as when the buttons are pressed, we don't want the housing to pivot on the bolt (picture left). Square the box before tightening the bolt. Route the wire down the handlebar and leave it loose near the front forks to be routed under the seat with the proximity sensor wires. Use wire ties to hold the wire to the bar.

At this point we need to find the proximity sensor & bracket and get the plug off the end. The wires from this sensor need to be routed from the front left fork area, up toward the handlebar, to join the wires from the switch box (See right picture below). Route the wires under the caliper cover.

Here is the fun part! We use a welding rod, but you may wish to use a coat hanger. Do whatever you have to do to feed the rod from under the forks to come out near the left frame rail (see arrow below). Now you can remove the wires from the plug on the end of the switch box wire, join them with the 3 wires from the proximity sensor, and tape the silver plugs to the rod you just fished through the bike.



Gently pull the rod and wires through the front fairing area until the wires appear (picture below left). Carefully pull on the wires, making sure they move easily. If not, there is a bind, pull the wires and rod back out and start over (Sorry!). Once this works out, carefully remove the tape to expose the silver pins. Route the wires carefully under the metal bracket above the fuel pump to protect the wires (right below). Make sure the wires under the fork have enough room to allow the bars to be turned and that they don't get caught on anything.

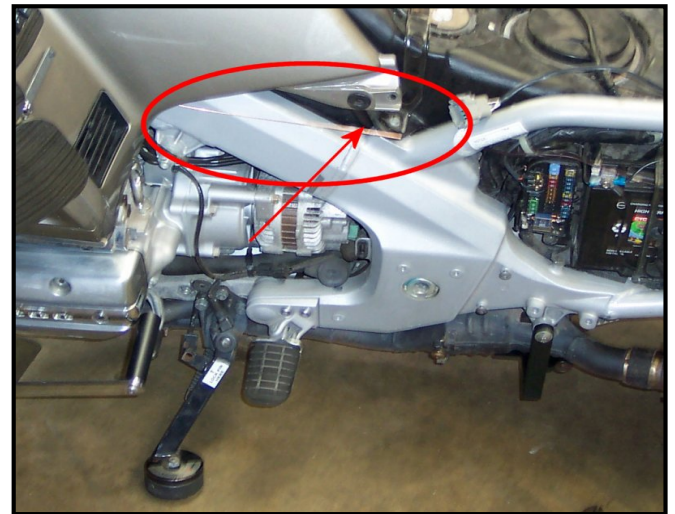
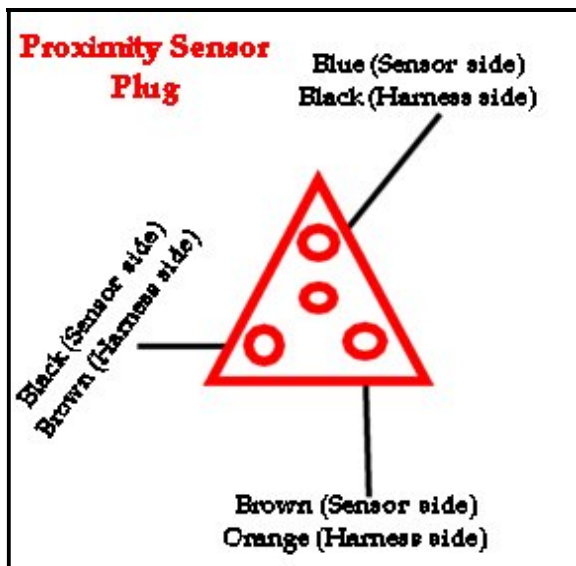

Due to global distributions problems, we may have to use a four pin plug instead of a 3 pin plug. The colors still need to be the same across the plugs with pin 4 empty!

The next step is to reassemble the plugs. Use the diagram on the next page for the switch box, and the picture above for the proximity sensor. Be very careful to make sure the wire colors all match those in the mating plug and the diagram. More mistakes are made here than on any other part of the install! Now onto the rest of the wiring harness!

Pin Out for Handlebar Control Box Plugs

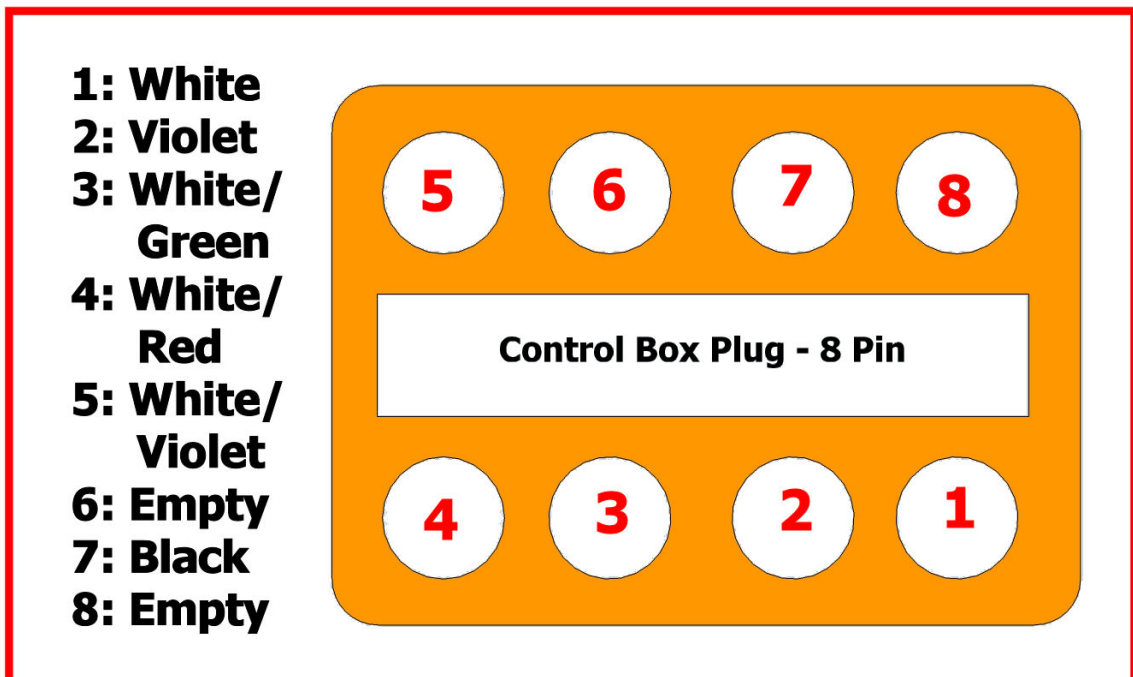
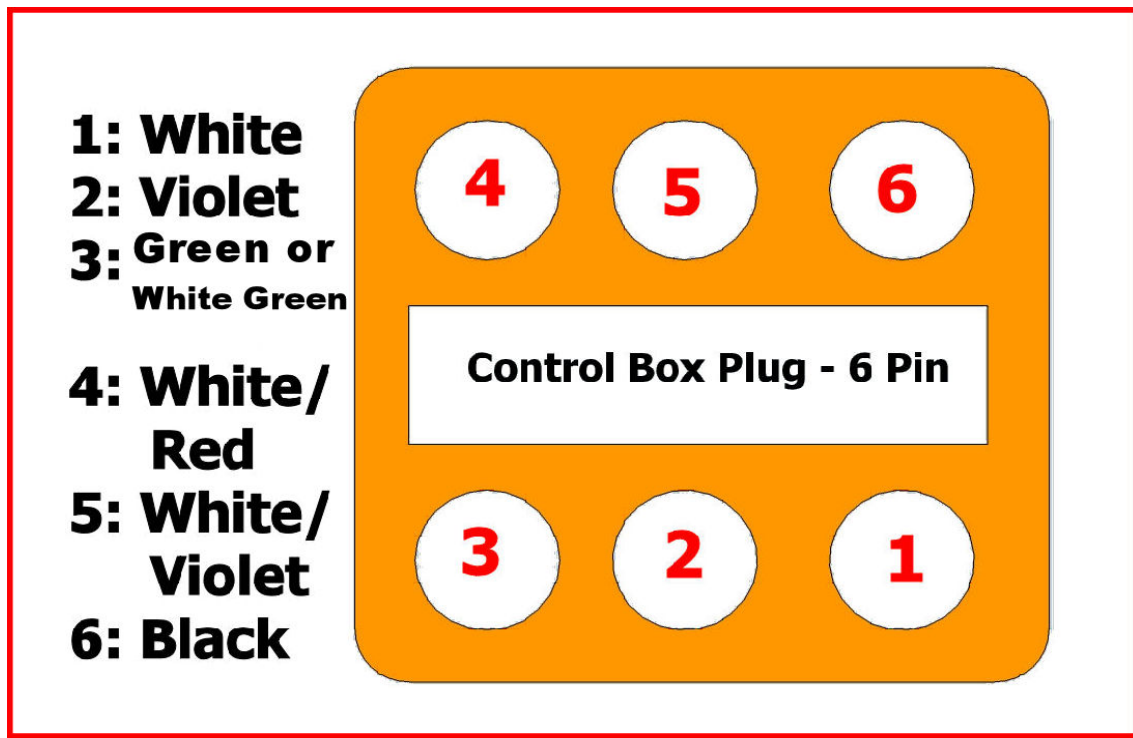

WIRING HARNESS

The next step is to route the wiring harness. The harness and the plugs are routed mostly under the seat, the left side cover, under the trunk and into the right saddlebag.

NOTE: If you have an F6B model, you can get to the inside of the right saddlebag by removing the seat cover (picture at the end of this chapter). There are other differences we can't cover in this manual. Much is the same, and the bags are the same. Read this entire section before proceeding. Understand what we show here, and you should be able to understand the differences.

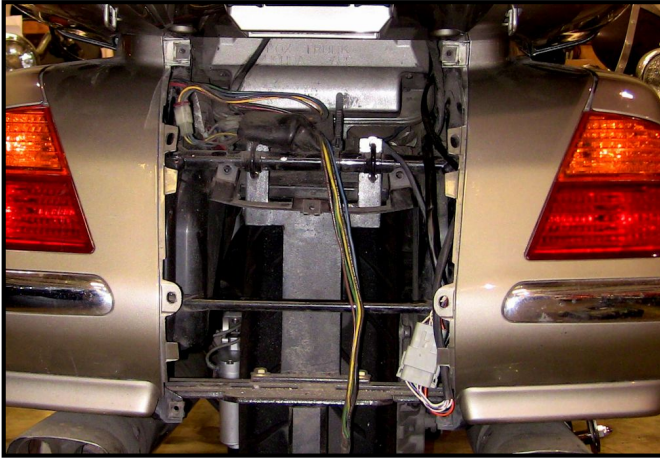

The most difficult task is taking apart the 12 pin plug on the harness and feeding it into the area under the trunk near the right saddlebag. As seen here, remove the four bolts that hold the back of the rear fender on. Then snap the panel off revealing the back of the saddlebags and the

structure under the trunk.

Next find the 12pin plug on the main harness and disassemble it. We want just the pins so we can thread the wires from under the seat to the area back here.

At the same time, we need the 2 long air hoses. We want to tape those hoses and the

wire ends to a lead wire (we use welding wire), and run it through as

shown. The wire started at the back fender, ran under the trunk to the spot you see here. The two long air lines and the pins from the 12-pin plug are taped here, and gently pulled to the back. Once they exit the back fender area, the tape and wire can be removed.

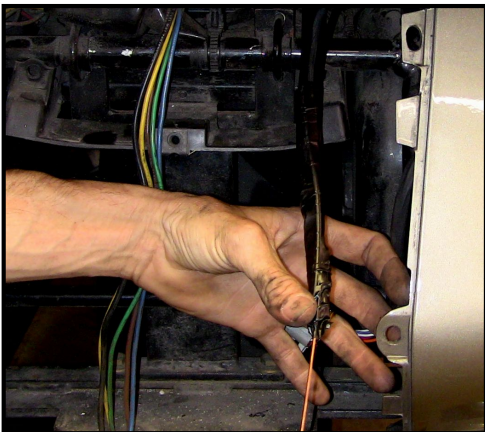

Once the tape is removed, we can reassemble the twelve pin plug, and just leave the air lines dangling for now. ***(See 'Illustrations' toward the end of this manual for diagram. IT IS CRITICAL that the plugs are assembled per the illustrations for future support!!!)***

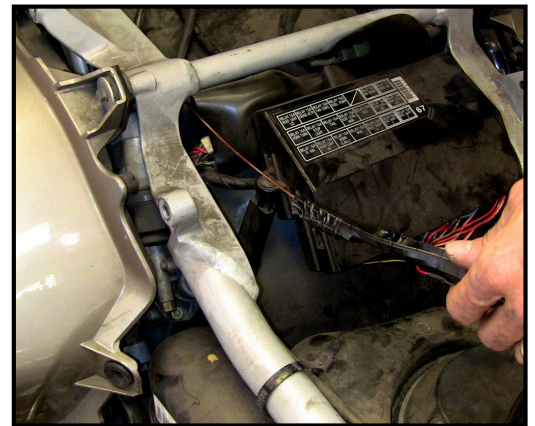

Find the proximity sensor (little yellow square on a bracket with a long thin wire with a three pin plug attached). The sensor and its' bracket should already be dangling near the left front fork.

NOTE: We will mount this bracket in this area later, but making sure you have enough wire to mount it and that the extra slack is pulled to the under seat area!

Make sure the wire is clear of everything, bearing in mind that you need to leave some slack to allow the suspension to move up and down. Once you are satisfied, plug in the proximity sensor with its' mating plug. Make sure the eight pin plug from the switchbox is plugged in as well.

Next we need to route 2 sets of wires to the left side cover area. One has two hoop connectors with an Orange and a Black Wire (On later harnesses, the Black wire is eliminated), the other has two thicker wires, Red & Black, one has a fuse holder and both have round connectors for the battery terminals. These need to find their way into the left side cover area. In the picture at right, you can see where we want to attach the two hoop connectors (after the cover is removed from the fuse box). Using a Phillips head screwdriver, remove the top screw, and attach the orange wire to this post. The black wire (if present) gets attached to the lower post. Notice that the wires can be routed out of the fuse box to the left where there is a relief for each. We strongly recommend that you replace the existing 5Amp fuse (second one down on the left) with a 10 or 15AMP fuse. This fuse only supports the orange wire here and a 5 amp fuse is just a bit too light. These connections are only on when the bike is either on or in accessory mode.

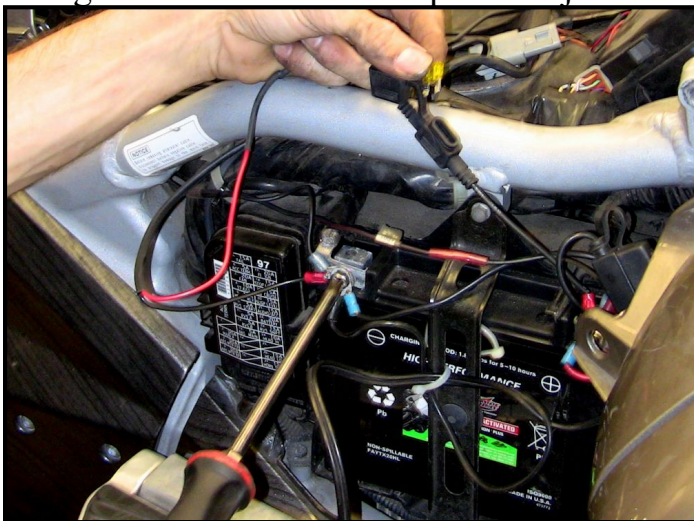
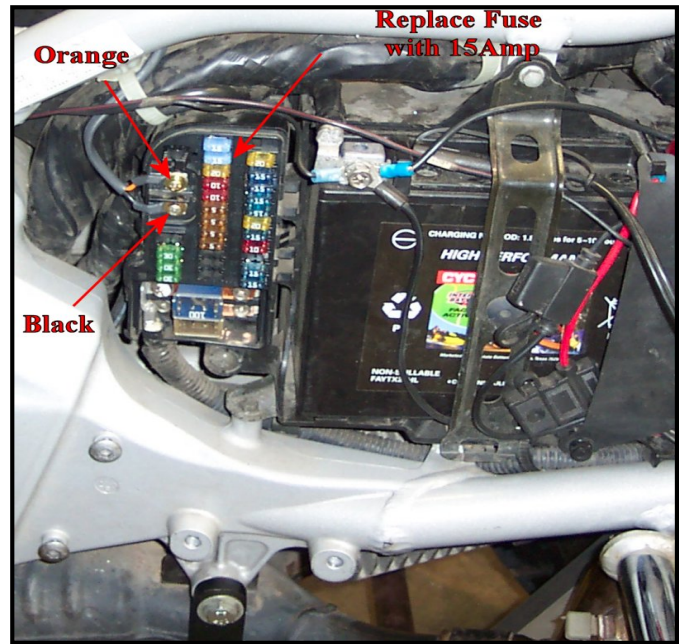

The other wires attach directly to the battery. The one with the fuse holder is attached to the positive post (we suggest removing the fuse for now!), and the black wire to the negative. These power the compressor through a relay! Notice the route of the wires underneath the frame rail.

All these wires will be cleaned up and tied off later; for now we will leave all the slack we have just where it is.

MISCELLANEOUS ILLUSTRATIONS:

Below is a shot of the F6B model with the rear fender cover removed. Find a way to get the air lines and plugs into the saddlebag, and a spot for the 12 pin plugs.

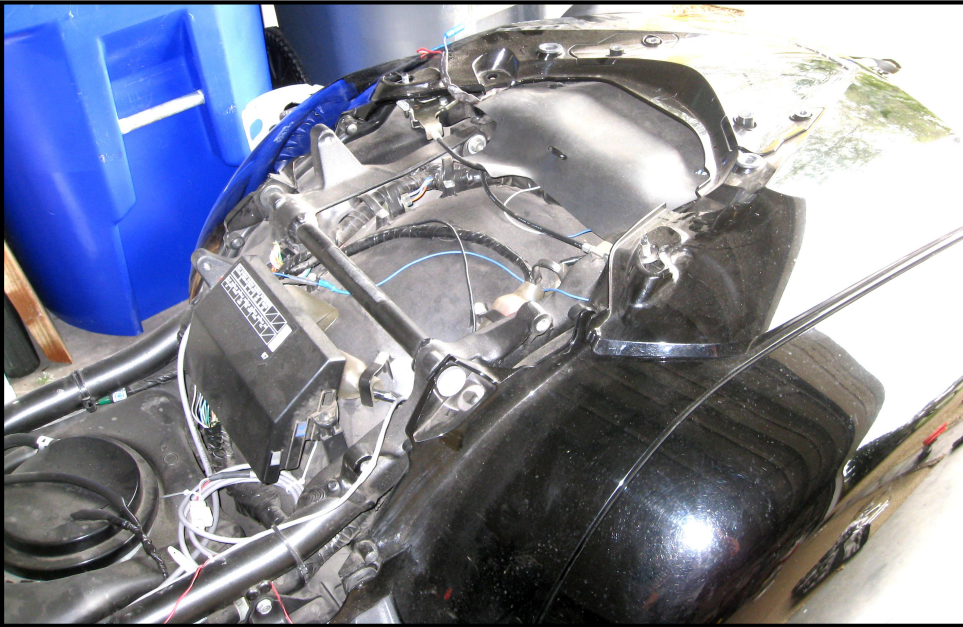

Below right is a shot from one of our customers showing how he got the speed sensor and switchbox wires from the front of the motorcycle, to the area under the seat. This shows the left side storage box and the left side switch pod. Notice the black wire snaking through both openings.

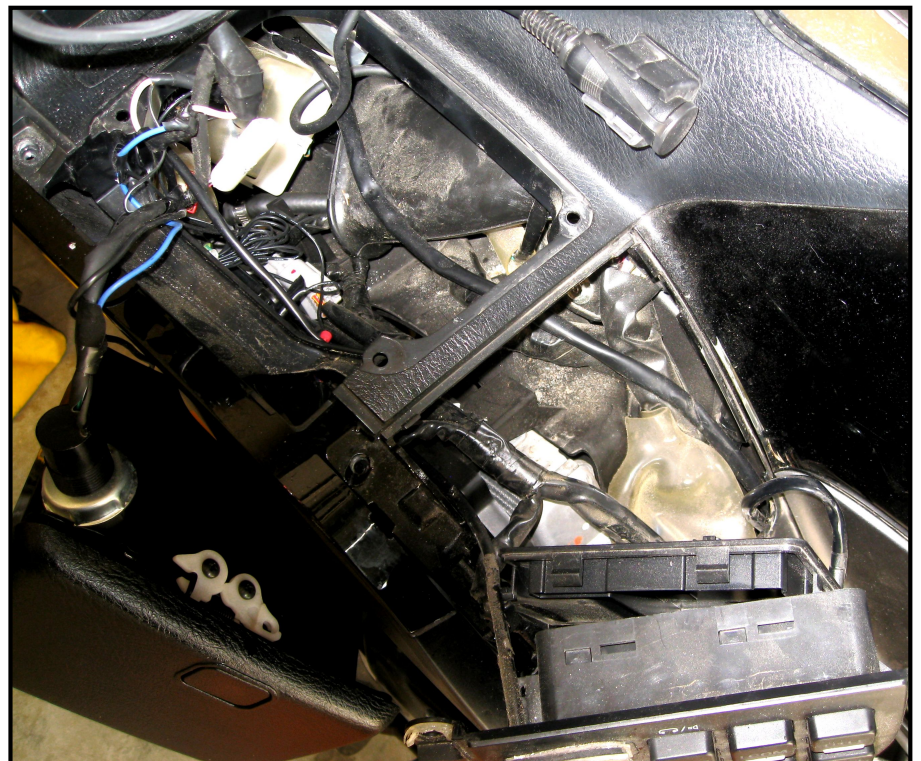

LEG & MOUNT ASSEMBLIES

Now we need to mount the Legs under the passenger floorboards. If you haven't already, we need to remove both floorboards. This is an easy task; just flip the floorboard up, revealing two bolts. Remove both and put the bolts aside; they won't be re-used!



We have found that mounting the floorboards to our assembly is easier before you mount the assembly. Find (2) 5/16" X 7/8" button heads and the locknuts (for each side). Slide the buttons heads in from the back, through the mount, then the floorboard and secure it with the locking nut. It should look like the



pictures here when complete. You can wait until the assembly is mounted to the bike to install the boards if you choose as well.

Take the Leg/Mount for the one side (shown below without the floorboard for clarity) and the two 3/4" spacers provided, and raise the assembly up to the bike as shown. Run an M8 Hex bolt through the assembly, into one of the spacers, and into the holes on the bike exposed after removing the floorboards. We suggest the front bolt be installed first, and then you can lower the leg against its spring to install and tighten the rear bolt.

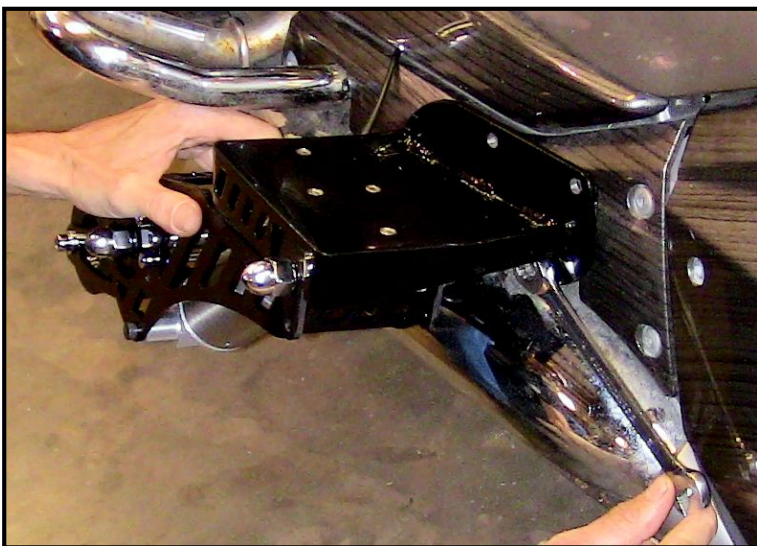

Make sure you use Loctite on the bolts and check them frequently for tightness. It may be easier to have an extra hand supporting the assembly, as it is a bit tricky getting to the two bolts. Repeat the procedure on the other side of the bike.

Let's run the air lines!

RUNNING AIR LINES

We need to route the air lines to the cylinders; this way we can protect the excess, and ultimately pull them into the right saddlebag.

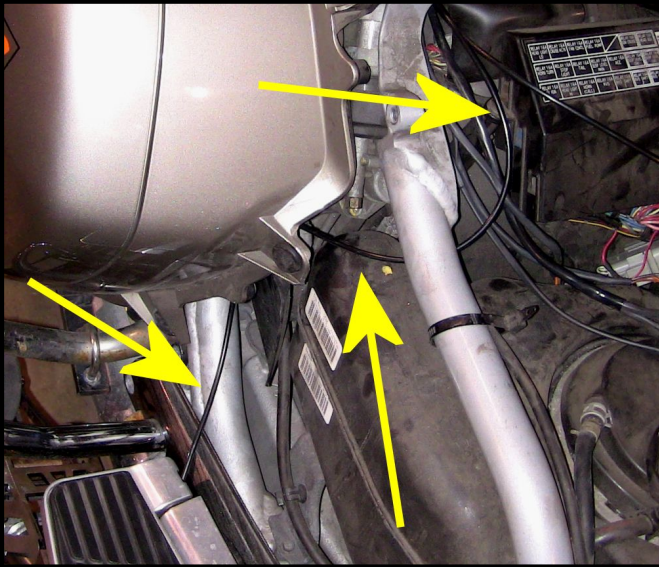

The air lines have been run to the back fender area already. You should keep track of which line is which (We may have marked one of them with tape!). Take the marked line and run it to the right-side cylinder as shown. This route keeps the line away from the pipe and anything else that may damage it. Once it is run, attach the end to the cylinder. It is easier to pull the leg down to install the line as shown below. These lines just press into the fittings. Once inserted, give the line a tug to make sure it is staying put! Next, run the

leg up and down and make sure you have enough slack to allow the wheels to deploy and retract.

We want to run the lines on the left side next. The picture shows the route. As you can see with both routes, we try to make sure the lines will not interfere with anything that could hurt them. Once both sets of lines are attached to the cylinders, we should tie them off where it is safe to do so, and send any extra length toward the back fender area. Make sure the installation of the seat will not damage the lines and that they are safe.

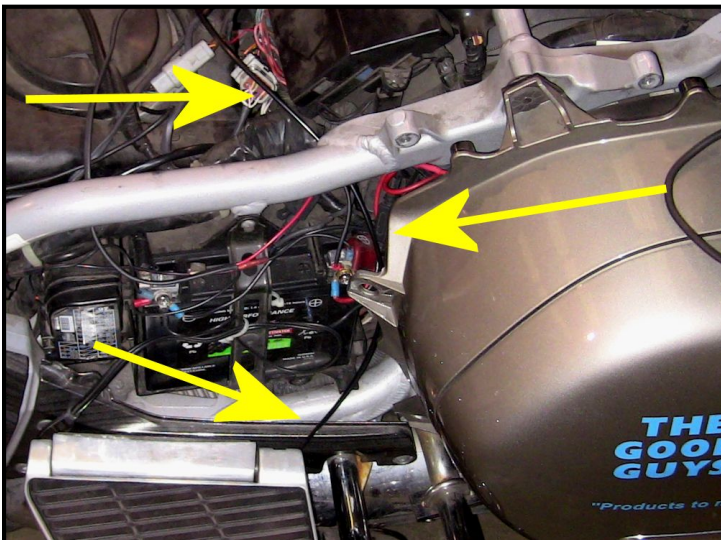
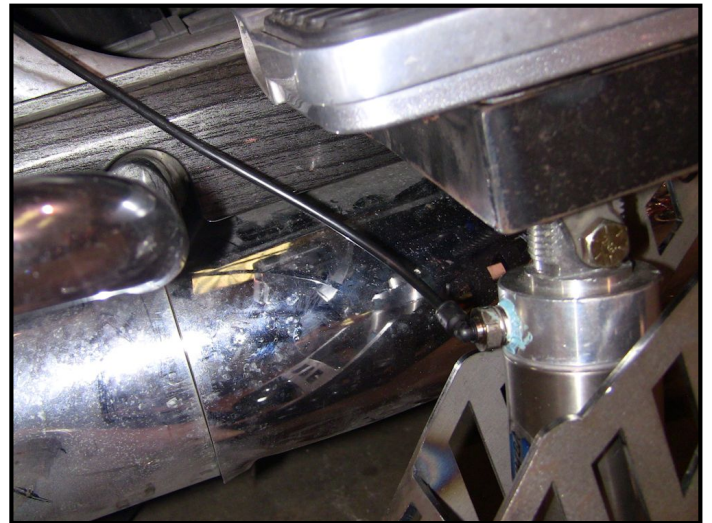

Before considering that the lines are tied off properly, put the side covers back on, and test the travel of the legs up and down, making sure nothing binds or damages the lines.

We will tie off the lines under the trunk area next!

Pull whatever extra slack you have in the air lines toward the back fender area. Double check the routing under the seat is safe and tied off properly!

As shown here, a single wire tie (where the finger is pointing) is a good place to tie off the lines. This assures the lines are as far away from the tire and any debris it may kick up as possible. Leave the end of the lines dangling as we will deal with them when we get them into the Saddlebag.

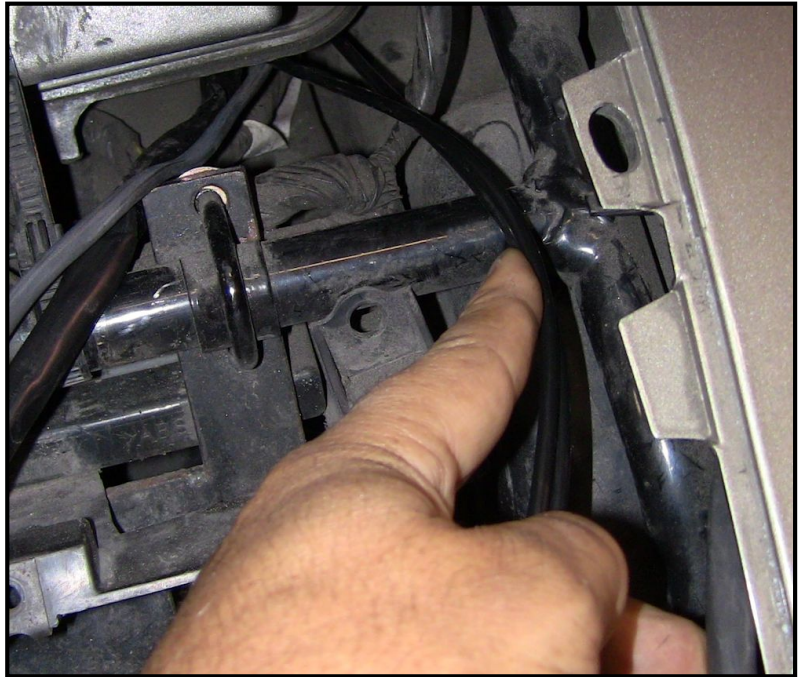

These are air lines, so tie them off snugly. Careful though; too tight could restrict the air flow.

Please Note: The side covers on both sides are a bit trickier to remove with the legs attached to the bike. Removing the seat helps, but the covers will come off without this. You can also loosen the attachment bolts if getting the cover off proves difficult. Just remember to re-torque these when completed!

Let's get the saddlebag ready!

SADDLEBAG PREP

The compressor system will reside in the right saddlebag. In order to get the air lines and the wires to run the compressor system and the wires to the computer, we need to drill two small holes in it.

The rear fender cover should still be off. Using the pictures as a guide, we want to drill (2) 3/8" holes in the bag; the top one should be right above the finger you see here, and the bottom right below. The bags are made from ABS, so the drilling is very easy.

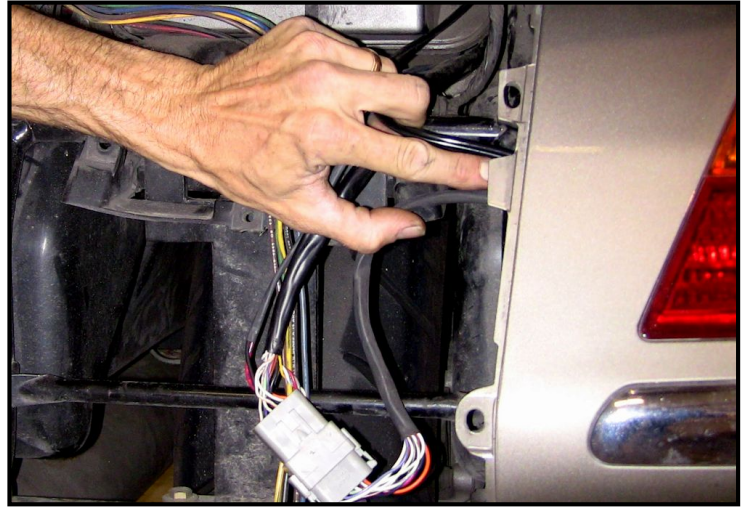

Before starting make sure everything is out of the right saddlebag, and reference the picture here that shows the wires and air lines coming through the holes.



As you can see, we want the holes just inside the edge of the bag. Exact placement is not critical; just try to get the holes about where you see them here.

The holes are high enough in the bag that Water from foul weather should not enter the bag, but if you are concerned, you can use a bit of silicone, or even duct tape at the end of the installation to assure that the bag stays dry!

NOTE: On newer model with the lights

above the license plate bracket, we recommend removing only the lower portion of the rear fender, drilling holes as high as you can, and using silicone on the inside to seal the wire and hoses. Don't seal this until later; we will tell you when. Because the holes are lower than on the older models, we want to make sure no water infiltrates the saddlebags.

INSTALL THE COMPRESSOR

Find the compressor, as shown here. We need to remove the top, as it won't be needed until the very end! We do this by removing the three nylon nuts on the top of the plate. These are only hand tight and they will be reinstalled without any tools as well.

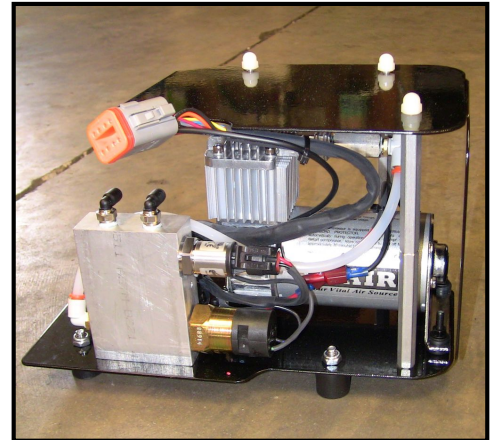

Before we actually install the compressor in the bag, we need to get some wires out of the bag, and the air lines in. Find the 'Y' harness connector as shown below. We should have shipped it to you with one of the 12-pin connectors off so you can thread the pins from the inside of the bag, out through the bottom hole that you drilled in the saddlebag, near the other plug that is in the rear fender area.

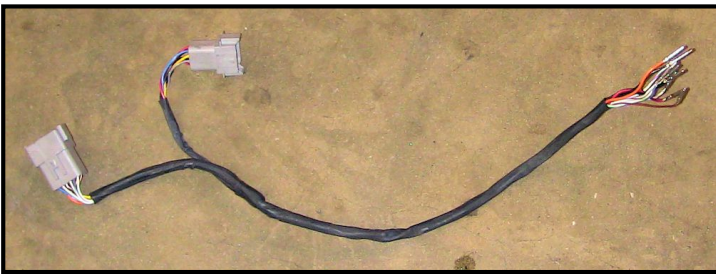

Once this wire is pushed through the hole, you should take the two air lines and feed them into the saddlebag through the upper hole. Pull any extra slack from the lines into the saddlebag, and leave the wires inside the bag, dangling for now.

We next want to reassemble the plug in the fender well you just ran through, and attach it to the 12-pin plug you assembled previously (*See 'Illustrations' toward the end of this manual for diagram*). The pictures on the previous page show what this should look like.

Let's get the compressor into the bag. It is hard to tell from the picture here, but before we get it all the way into the bag, we want to attach the 8-pin plug (from Y Harness) to the plug on the compressor assembly (12-pin plug stays loose for now!), and attach the air lines to the fittings on the aluminum block (top of pic). Once these are all connected, you can tilt the compressor up as shown, and work it into the very back of the saddlebag. It is a tight fit, but once the high end moves back far enough, it will be able to be lowered flat!



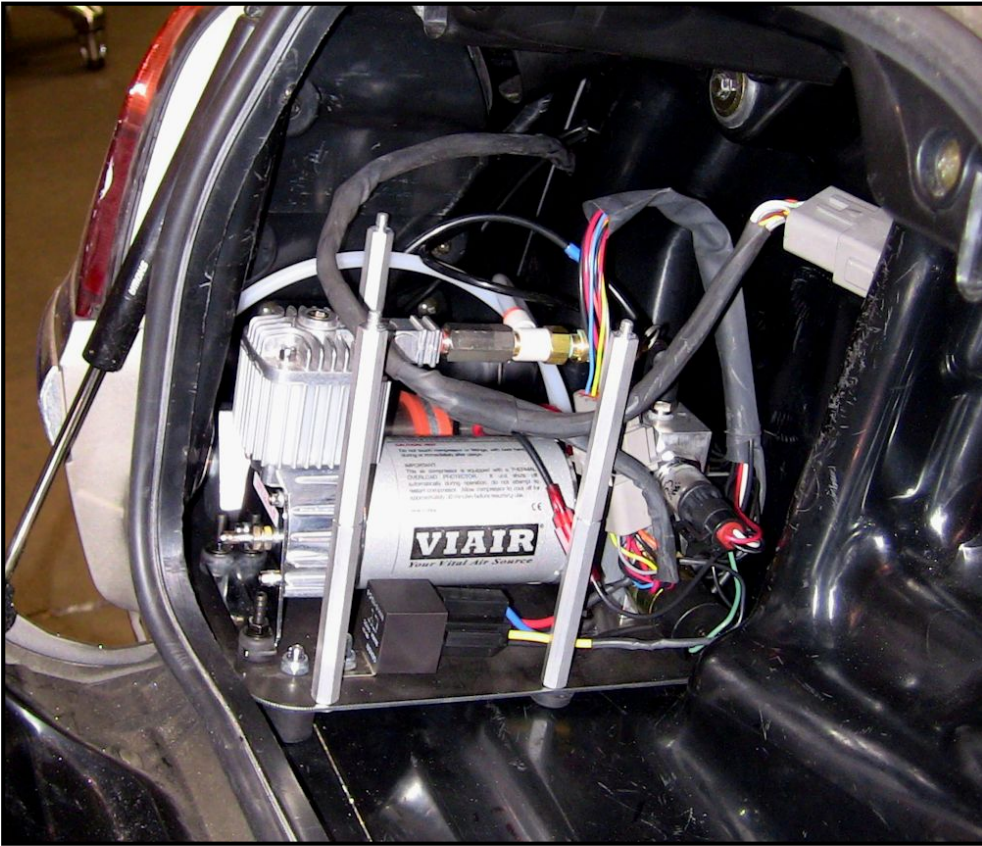

Here is a picture with the compressor in its' final resting spot (without the top). We want to pull the extra line and wire into the area above the compressor. When you are done, we would like to make sure that the hoses are not resting on the fins of the compressor (they can get warm!). We will put the top on later to make this all pretty.

Next we should find the computer, and plug it into the remaining 12-pin connector. Just let it lay loose in the bag for now.

We are about to do some initial system testing so make sure that the negative terminal of the battery is connected, and the fuse holder we installed has the fuse in it!

INITIAL SYSTEM TEST

Turn your bike to *Accessory Mode*. This is all the way to the right on the key on the GL1800. The screen on the dash should light up, and if everything is working properly, the compressor should turn on for about 6 seconds to fill the onboard air tank. At this point, have a look at the yellow proximity sensor.

PLEASE NOTE: Immediately after turning on your bike (within 5 seconds), the top light on the handlebar control will flash for a few seconds. This is the system either making sure that no air is in the legs if they are up (for safety it makes sure air does not build up when the legs are in the up position), or that the proper amount of air is in the system if they are down (again for safety to make sure the legs stay pumped completely!). This test occurs once a minute for all the time the bike is powered up, whether you turn the LegUp system on or not!

The **RED LED (ON The Sensor)** ***Should Not Be Lit***. Take a metal object (screwdriver, wrench, etc.) and hold it on the flat face of the sensor (it has a circle embossed in it). The LED should light up, and go out when you move the metal away. If not, check all your connections.



Next, press the rightmost pushbutton on the handlebar switchbox, and hold it for at least 3 seconds. Both LEDs on the switch panel should light up; green means the legs are up and yellow means the bike is traveling under 6MPH. If this occurs, you are doing well.

The next step requires some care. If the bike is still on the lift, have a helper hang on to it as you touch the left button for just a split second. The legs should move down, likely until the wheels hit or miss the lift, and they do this **VERY** quickly! The compressor will likely start and run for about 10 seconds. Press the left button again and they should move up.

If all of the above has occurred, great! Turn the ignition switch off, the test is complete!

Let's move on to mounting the Proximity Sensor.

MOUNT PROXIMITY SENSOR

This step is crucial!! Understand it before starting. The proximity sensor tells the system how fast the bike is traveling. The proximity sensor mounts to the bottom left pinch bolt of the left front fork. Remove this bolt, install it through the bracket and reinstall the bolt semi-tight, so the bracket can be moved if need be (a little Loctite please!). You need to jack up the front wheel or have the bike on the ground so we can spin the front wheel to test the sensor and its placement. Make sure the bike is in neutral.

The sensor will track the rotor bolts on the front wheel as it spins, and is to be mounted 5MM away from the bolts or closer; like the picture below. Once the bracket is mounted, turn the key to the accessory position, spin the wheel or roll the bike and watch the behavior of the sensor as the bolts pass it.



The LED on the sensor should be off when no bolt is passing the sensor, and the LED should light when a bolt passes by the sensor. Play with this by rotating the wheel back and forth while adjusting the bracket in, out, left or right until the light blinks consistently.

Once you feel you have the right place, tighten the bracket down and slowly rotate the wheel. Every time a bolt passes, the light should get bright when the bolt is nearby and off after it passes.

If this is not happening, you may need to get the sensor a bit closer to the bolts (5MM is a very small distance!). If you have to move the sensor closer, just loosen the bolt again, and re-adjust the sensor. No matter what you need to do, you **MUST** make sure that as the wheel turns, the light works as described above! Once you are certain, tighten the bracket down very firmly! Re-check that everything functions properly by spinning the wheel past all 6 rotor bolts and verifying that the LED changes as described above. The automatic retraction of the legs as well as their deployment **RELIES** on this sensor being placed perfectly!

Once satisfied with the mount, make sure the wire running up the fork leg is tied off, clears everything, and can't get damaged by anything.

WIRE ROUTING

Now we want to tidy everything up. The cover can be placed on the compressor using the three nylon nuts removed earlier. Make sure the hoses and wires stay under the cover and the computer wire works its way to the top as shown here. You can attach the computer to the top with the Velcro provided.



Next we want to make sure that the wires and air lines under the seat are tied off neatly and can't get hurt by the seat being replaced. The picture below is typical. We pull all excess wire under the seat, tie it off neatly and tuck the plugs (3 of them) out of the way.

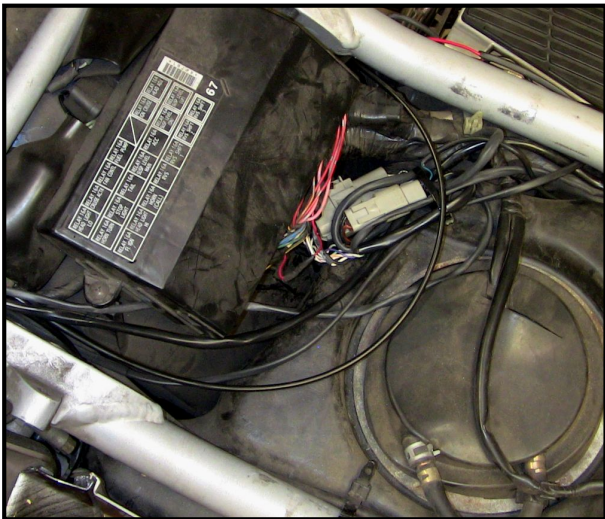

We also made sure that the air lines would not be under any stress after the seat was installed.

The area under the trunk was next. We connected the plug and tied it off high so it was away from the spinning tire and any water it might kick up. The plug is water tight, but no reason not to be thorough.



If you had to drill the holes lower because your newer bike has the taillights above the license plate bracket, THIS would be the time to seal off the wire and hoses that enter the saddlebag!

Once this is accomplished put the rear fender insert back in place and install its' four bolts.

Let's start finishing up!

FINISHING UP

Now it is time to reinstall everything you took off, and do final checking of everything! Reinstall the seat making sure all your wires are routed neatly, tied off nicely and don't interfere with the seat installation. Side covers go back on making sure the wires to the battery and fuse box are neatly stored, and the air lines are not in any sort of bind!

Once all of this is accomplished, we should get the bike on the ground, and with a helper, cycle the wheels up and down manually a few times, having your helper make sure the air lines are not being scuffed or are over tight, and that the lines are out of the way of anything that could damage them. Double-check all your bolts for tightness. Now we can dial in the legs, and adjust the wheels if needed.

LEAKS!

This system uses air, and air loves to leak! The fittings we use are tested for leaks before shipping, but we have a few simple tests to make sure you have no leaks or just insignificant ones if any.

Set the wheels down and leave the system on. Put the kickstand down, and turn the bars all the way left.

If the compressor makes noise more than once every two minutes, you may have a leak at the lines that connect to the compressor or the tank fittings. Some soapy water will tell you where (you will need to remove the compressor top to test for these leaks).

Assuming the compressor doesn't lose enough air to kick on after 2 minutes, you should be fine.

You can turn the bike off, and wait to see if in 5 minutes the bike is not as stable as it was when the wheels were first lowered. If it lasts the 5 minutes and is still very stable, you could still have a leak, but not one that would be a problem on the road!

Leave the bike on its wheels overnight (again kickstand down, bars full left in case the legs lose a lot of air; the bike will land on its stand). If in the morning, the bike is still stable you have no leaks.

If there are leaks, the fittings on the air cylinders would be the first for the soapy water check, with the two small line fittings on the compressor next! If you need help with these, please feel free to call us at (407) 834-5007.

FINAL ADJUSTMENTS & MAINTENANCE MODE

The next two sections are typically **NOT** needed. We include them to document your system thoroughly, but **MOST** people will never need to use either section.

MAINTENANCE MODE

NOTE: Maintenance mode is a procedure that ‘TEACHES’ the computer how much pressure to use when it lowers the wheels and how much pressure to release when raising the wheels. We always set this at the factory; ALWAYS!! We include this procedure in case it is ever needed in the future. Please skip this section unless you have been instructed to reset the system by Chopper Design.

Turn the ignition to Accessory and start the LegUp System (hold right button for 3 seconds). The system should be set at the factory for proper pressure, but some wheel adjustment may be needed. If it has been determined that ‘**Maintenance Mode**’ is needed, Sit on the bike, and hold it level. If both lights on the switch box are flashing, the system is in maintenance mode. If not, **PRESS & HOLD** both buttons until all lights flash. ***(Do your best to press both buttons at the same time so the system doesn’t respond to what it thinks is a request to lower the legs)*** Once flashing, hit both buttons for an instant to get the system in the ‘**DOWN**’ setting mode (lower, yellow LED flashing). Touch the left button briefly; the wheels should go down immediately. ***(This is VERY quick, don’t be startled!)*** Using very short pushes of the left button, press and then feel the stability of the bike. If it feels firm enough, try leaning the bike a bit. If the wheels return the bike to upright, there is likely enough pressure. Put your feet on the floorboards; the bike should stand on its’ own. Rock the bike a bit left and right, being prepared to put your feet down. If the bike continues to come back to upright, the **DOWN** stop is now set and we can move on.

Hit both buttons for a moment to get into the ‘**UP**’ stop mode (Usually hitting the left button just before the right assures that air is not released!) The top LED should now be blinking. Press and hold the right button to raise the legs. Listen as the air evacuates; once it is quiet, let go of the right button. The **UP** stop is now set! Hit both buttons when complete, Both LEDs should light, and you are done with these adjustment.

Now press the left button and the legs should lower; again this is fast and loud. The bike should be held up firmly! Hit it again and the legs should retract. If you are satisfied with these limits, you have successfully installed the LegUp System.

WHEEL ADJUSTMENT

The LegUp GEN II system is typically set up at the factory for the height of your bike. The system is VERY height dependent! If after testing the initial installation, the bike does NOT feel stable, the wheel system MAY need to be adjusted to the height of your bike. AGAIN, we normally ask at order time if your bike is at stock height and we set the system up for whatever height you have furnished us. DO NOT make any changes unless the stability we expect is NOT present! If you feel you need to adjust the height/length of the wheel holders, please read this ENTIRE section before starting the process. If you need help, please contact Chopper Design at 407-834-5007.

If you are happy with how stable the bike feels, you can skip this section, and move on to a test ride! If you are not sure, or you skipped **'maintenance mode'** as instructed, a good test is to bring the wheels down, put the kickstand down, and lean (or try to) the bike on its kickstand while sitting on the bike. If the bike comes back to center without your help, or you put your feet on the boards and can bring the bike up by just leaning to the right; move on to the next section (Test Ride), the wheel settings are fine!

The stability of the GEN II LegUp system, relies on the pneumatic actuator, when deployed, being at an angle that is forward of perpendicular for best results! Different bikes are at different heights, and Chopper Design uses an ingenious method to adjust the length of the supporting legs to maximize the stability it affords.

Typically, we will send the 'Leg Assemblies' set up for perfectly for your bike. In the event your bike is at a different height than stock, the information and adjustments that follow may be required.

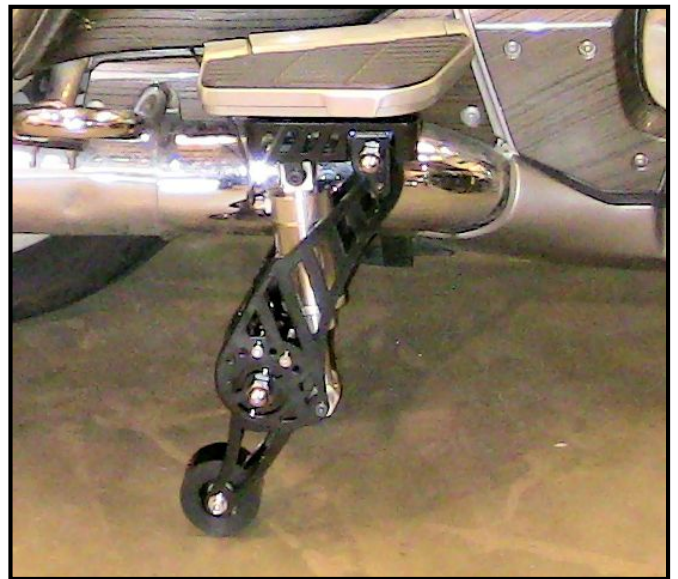

PLEASE NOTE: The GEN II system is bike height sensitive, and Gold Wings can sink when loaded two up. You should test the stability of the system with a passenger and adjust the air shocks to stiffen the suspension and get the stability you have here with a rider. You may need to re-adjust the shocks for solo riding as well.

On the next page, we show you the wheel holders which should help clear up any confusion you may have about the wheel holders and their adjustments.

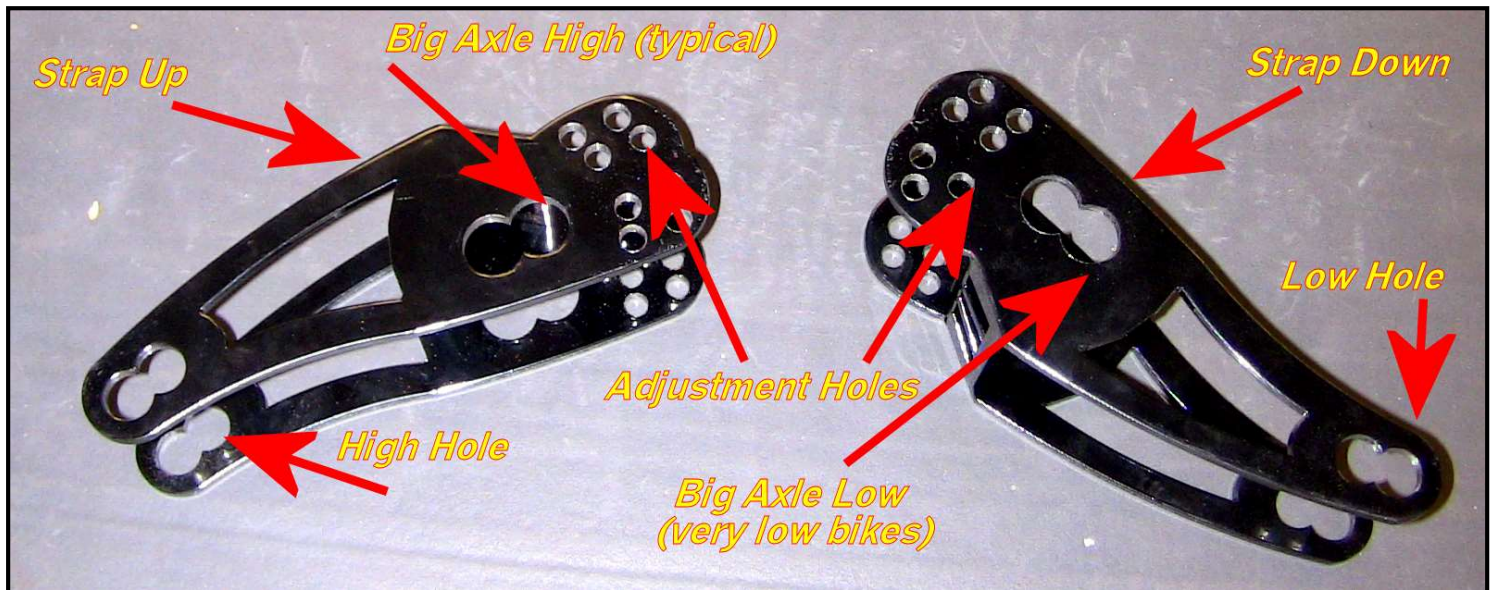

On each supporting leg, you will find two bolts down near the end by the wheels. The two bolts control the angle of the ‘Wheel Holders’. By moving the wheel forward or back, we can tailor the length of the support arms to a particular bike.

A helper is handy here. Make sure the wheels are up. Make note of exactly which two holes the bolts are in. Loosen the locking nuts from the back and remove the bolts; you will notice the ‘Wheel Holder’ can pivot on the big axle bolt. Starting on

the left side of the bike, move the bolts one hole counter-clockwise. Go to the right side and move them one hole clockwise. Loosely fit the nuts (no need to final tighten them at this point).

Lower the legs. Is the bike more or less stable? If it is more stable, and you can sit on the bike and rock it back and forth without it leaning over you are done. If not, remove the bolts again, and move them in the opposite direction two holes, and retest. If everything is fine, final tighten the lock nuts and you are done.

If you need to, you can move the wheels from the lowest hole, up one hole. You can remove the wheel holders, turn them over (strap up instead of down for example) and install them on the other side of the bike. You can move the big axle from the low to the high hole. All these techniques take patience, but allow significant flexibility to tailor the system to your bike. On the next page we show you some examples. Normally you do not need to do **ANY** of these adjustments, but if you need to, we wanted to teach you the methods at your disposal.

TEST RIDE

PLEASE NOTE: Immediately after turning on your bike (within 5 seconds), the top light on the handlebar control will flash for a few seconds. This is the system either making sure that no air is in the legs if they are up (for safety it makes sure air does not build up when the legs are in the up position), or that the proper amount of air is in the system if they are down (again for safety to make sure the legs stay pumped completely!). This test occurs once a minute for all the time the bike is powered up, whether you turn the LegUp system on or not!

Get the bike to a clear paved mostly level area where you can test ride it. Start the bike, turn on the LegUp system and lower the legs. The first test should be done in a straight line. Put the bike in gear and slowly accelerate. You may notice that the bike tends to want to steer a small amount left or right. This is normal unless it is severe. Effectively, you are driving a trike, and steering is done with the handlebars **NOT** by leaning. Once underway, (we recommend you keep your thumb near the left button and press it to raise the wheels if there are any surprises) the top LED should flash at around 6 MPH, meaning the legs are retracting. It is difficult to lean on one wheel or the other as you leave, so you may wish to raise the wheels manually if the bike is steering due to uneven pavement.

Assuming the legs are retracted, you should try to deploy the wheels. As you come to a stop, the Green LED should be on. As you slow down (**almost stopped**), the Yellow LED should illuminate at the proper speed. Once it does (sometimes hard to see), hit the left button and put your feet down near the ground. The top LED should flash and the wheels should deploy almost instantly underneath you! Make sure you are ready to balance the bike, though you likely won't have to! Immediately after the wheels touch the ground, the bike should be supported reasonably, but the cylinders can take up to 6 seconds to get completely filled. Make sure you balance the bike as this occurs. The slower you are going when deploying the wheels, the smoother the transition will be from wheels up to wheels down. Practice these maneuvers until you are comfortable with the wheel adjustments and the system operation.

NOTE: With the system on or off, if the legs are up, the computer will leave the exhaust ports open at all times. This is a safety feature to make sure pressure does not build inside the legs, causing them to deploy! The top light may flash once a minute for a few seconds. This is completely normal, and the left button will be inoperable while this occurs.

SEMI-AUTOMATIC DEPLOYMENT: Another way to deploy the legs is semi-automatically. First we must be **SURE** that the proximity sensor is working properly or the wheels could come down at higher speeds than we wish. If you are travelling at a speed over 6 MPH, AND the yellow light (bottom) on the handlebar control is out, hit the left button. The bottom or yellow LED should start to flash. When you slow down to around 5MPH the wheels will deploy (see the red/green flash on top LED). Again prepare to put your feet down. IF the lower LED is lit at a speed over 10 MPH, don't hit that button; see caution below!

NOTE: The bottom LED Should not be LIT SOLID if the bike is travelling over 10MPH! In the event it is, the wheels will deploy instantly if you try to set them as above; this is dangerous! You MUST re-visit the sections on testing the proximity sensor. You should always be aware that this light should NOT be on if you are traveling at speed, and 'Arming' the system for deployment should only be attempted if the lower LED is Not Lit! Please see the User Manual for more information on Proximity Sensor Failure!

The next thing to try is to make a turn from a dead stop with the wheels down. As soon as you start the bike moving, turns can only be made by using the handlebars. The LegUp system is too strong to allow a great deal of lean with the wheels down! If you need to make a turn shortly after departing from a stop, raise the wheels manually (left button) and you will get complete control again.

The next thing to try is slow speed maneuvering with the wheels lowered. If you keep your speed down, most slow speed maneuvers can be accomplished with your feet up, keeping in mind that at about 6 MPH the wheels will come up automatically! You can try full lock turns in both directions and the bike should stay upright with your feet up.

Understand; it is always a good idea to keep your feet near the ground during these maneuvers if you can. A mechanical failure or a wheel in a pothole could upset the bike.

Because the wheels are right behind your legs when they are down, we recommend not trying to push with your feet to move the bike forward. Use the engine and keep your feet out of the way; this way the legs don't bite at your heels as the floorboard always have! Backing up using your feet works fine and the chore of balancing the bike is taken care of for you.

Practice, practice, practice!! Enjoy your LegUp System!

GENERATION I UPGRADE INSTRUCTIONS

NOTE: Read this before starting your installation if this is an upgrade!

If you are upgrading from a Generation I system, most all the instructions in this manual pertain to you, but some do not! The most important thing is to **NOT** take your wiring harness off the bike! We should have supplied you with an upgrade harness that will allow you to keep most everything as it was, and adapt the wiring to the new system. The second **VERY** important thing is that your computer **MUST** be sent in for upgrading or it will not work with the new Generation II system! With those facts in hand, let's get to it!

We will assume you have already removed all your Gen I hardware. The legs, the actuator mounts, the mounting plate. All you should have left from the old system is the wiring harness.

You must take the 12 pin connector out of the trunk, and run it to the area under the fender, as described in 'Wiring Harness' Section. While you run this wire and attach the air lines to it, you also need to attach the pins (not the hoops) of the 2-wire harness (Big Black & Big Red Wires) to be pulled to the same place. Once these are pulled, the Yellow, Blue, Grey & Small Red wires should be removed from the plug, tied off, as they will not be reinstalled in the 12-pin Connector.

Follow the instructions for reassembling the 12-Pin plug (Big Red in pin 3 & Big Black in Pin 4).

The thin wire with the fuse holder on it gets run back toward the seat area to get connected to the battery. You can tie this up to the existing harness wires along the route back to the battery.

These are only suggestions; run the wires anyway you like; your existing connections to power will remain as they are. One caveat is that the plug that used to run to the actuator will have no plug in it. This should not be a problem assuming it is stored in an area that does not get very wet.

When reading the install manual, you should be able to ignore most all instructions having to do with wiring and you will **NOT** need to do the proximity test by rolling the bike, as this should remain mounted.

If you have any trouble with this upgrade, please give us a call at 407-834-5007.

ILLUSTRATIONS

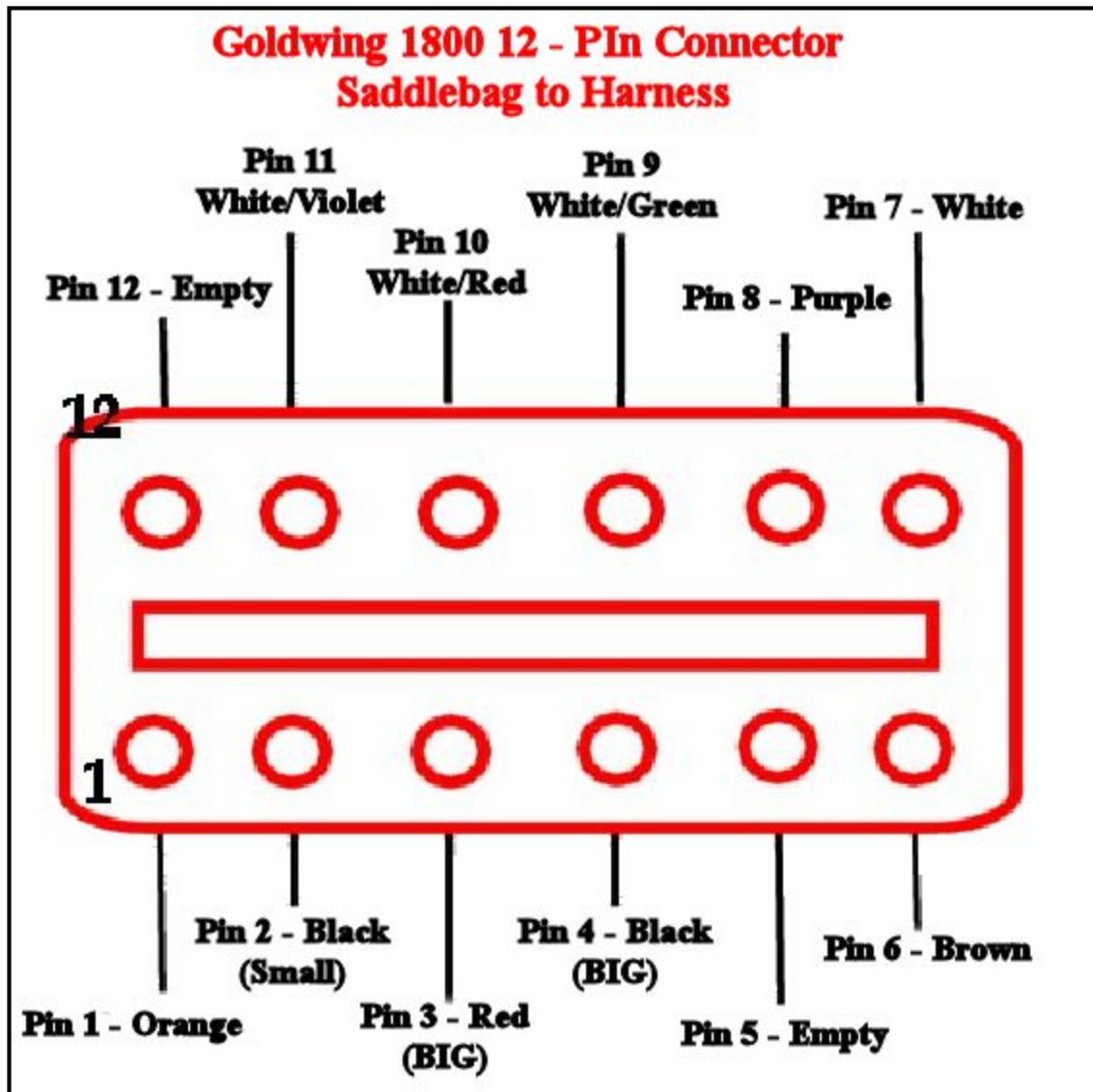

There are (2) 12 pin plugs to be assembled; the Female plug (male pins) from the harness under the seat, and the Male plug (female pins) going through the saddlebag. It is **IMPERATIVE** that you assemble them just this way so if you ever need support, we will know how to help! This could save you hours of aggravation.

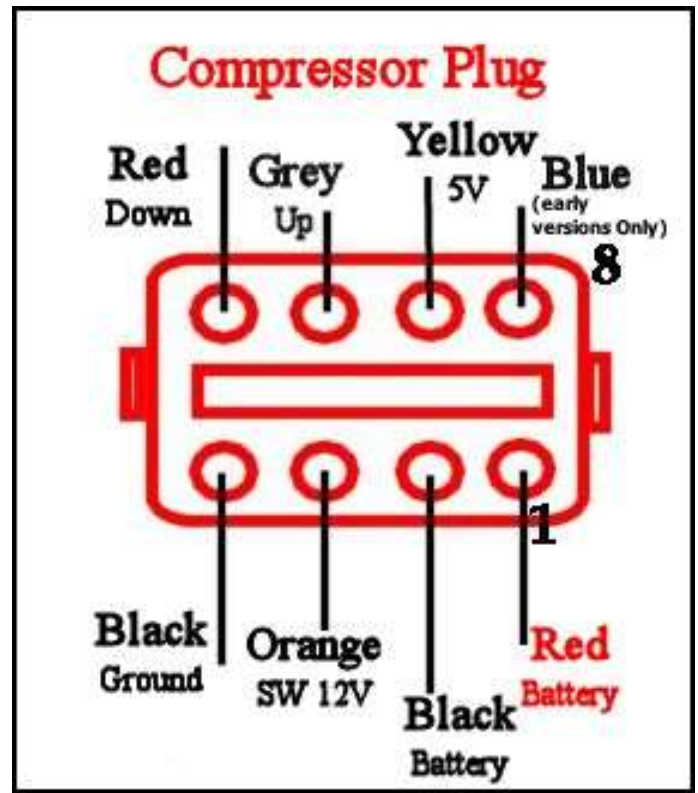
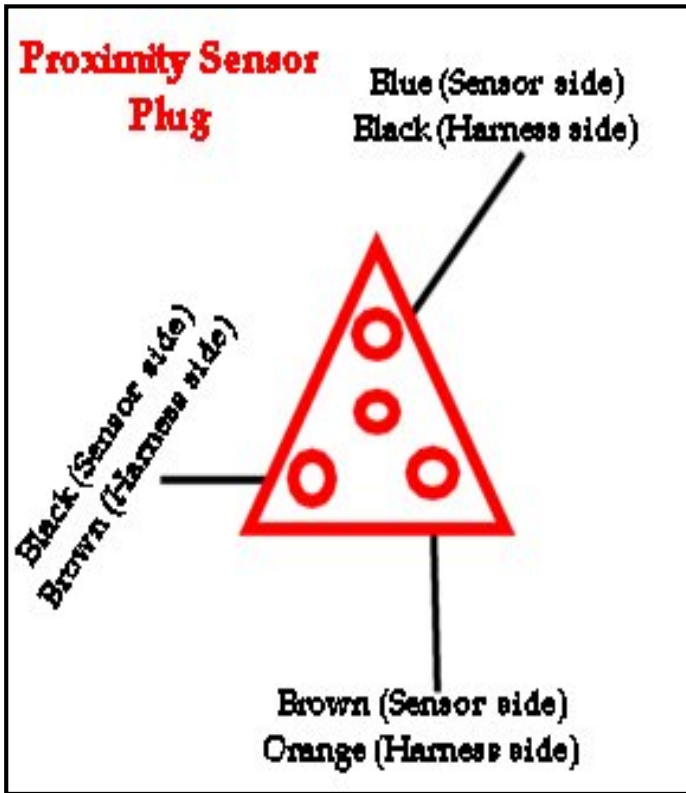

Due to global distributions problems, we may have to use a four pin plug instead of a 3 pin plug. The colors still need to be the same across the plugs with pin 4 empty!

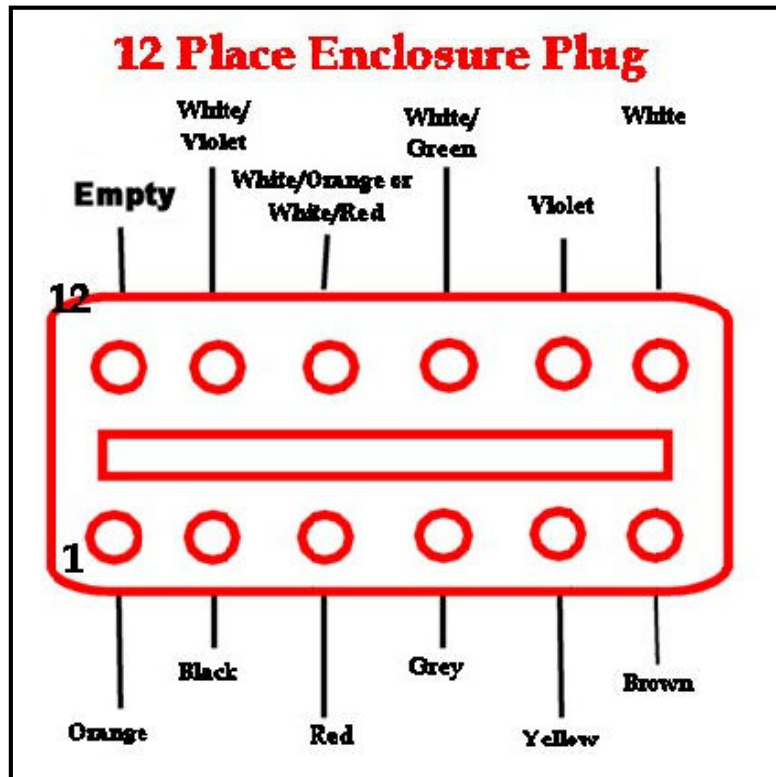

HARDWARE LIST

- (4) M8 X 50MM Hex Bolts with Washers (Leg Attachments)**
- (4) 3/4" X 3/4" X 3/8" Aluminum Spacers (Leg Attachments)**
- (4) 5/16-18 X 3/4" Button Head Bolts with Lock Nuts (Footboards)**

- (1) M5 X 70 Black Allen Head Bolt (Handlebar Bracket through Spacer to Bike)**
- (1) .875 X .375" Aluminum Spacer (Stock Handlebar Box spacer)**
- (1) 10-32 X 1.25" Allen Head Bolt (Handlebar Box to Bracket)**
- (1) 10-32 Acorn (Under Above Allen)**

- (2) 5/32" Black Air Line, 7 Foot long**

Hardware Bag with ties, etc.

Dismantle Handlebar Plug, Speed Sensor and Both 12 Pin Connectors for Interconnect Harness