



US PATENT # 8,235,419 B

Installation Manual

Generation II - GL-1800

2018-UP

**Copyright 2018, Pete Giarrusso, Inc.
D/B/A Chopper Design Services
All Rights Reserved**

Table of Contents

INTRODUCTION	4
WARRANTY	5
INSTALLATION INSTRUCTIONS.....	6
PREPARE FOR INSTALLATION	7
CONTROL SWITCH BOX.....	8
WIRING HARNESS	11
RUNNING AIR LINES.....	16
INSTALL THE COMPRESSOR.....	18
INITIAL SYSTEM TEST	20
MOUNT PROXIMITY SENSOR.....	21
WIRE ROUTING.....	22
FINISHING UP.....	23
<i>FINAL ADJUSTMENTS & MAINTENANCE MODE.....</i>	<i>24</i>
<i>MAINTENANCE MODE</i>	<i>24</i>
<i>WHEEL ADJUSTMENT.....</i>	<i>25</i>
TEST RIDE	27
ILLUSTRATIONS	29

Introduction

This manual covers installation of the Generation II LegUp LandinGear system by Chopper Design Services. This system should only be installed by a qualified technician, or those with above average mechanical skills. If you are not **SURE** that you can perform this installation, please contact us and we will help you find a qualified shop to assist you.

While the Generation II System holds your bike upright very well, you are **STILL** responsible for balancing the bike! The system **WILL** relieve you of some of the weight of the bike and help you avoid balance problems as you approach a stop, maneuver at slow speeds, and back the bike up.

Improper installation will void your warranty, so please be very careful!

Thanks for choosing LegUp!

Warranty

Chopper Design Services warrants the LegUp system for a period of one year from date of purchase. This warranty covers replacement parts and/or manufacturer defects. Incidental damages or costs are the responsibility of the purchaser.

Defective parts are to be returned to Chopper Design at the address below. Purchaser must contact Chopper Design to receive a Return Material Authorization, prior to returning defective parts to Chopper Design.

Abuse, improper installation or use, collisions or accidents, are not covered under this warranty. Replacement parts for this type of damage are available through Chopper Design.

Users of the LegUp system agree that Chopper Design is NOT responsible for personal injuries or damage to property arising from the use of the system. While we believe this system to be safe and reliable, the user is advised that use of LegUp is done so at the users' own risk. Use of the system implies agreement to the above statements. If you can't agree with the above, Chopper Design and its dealers would be happy to refund your full purchase price, before you use the LegUp System.

Chopper Design Services
1365 Bennett Dr. #101
Longwood, FL 32750

407-834-5007
LegUp@LandinGear.com

INSTALLATION INSTRUCTIONS

The LegUp® system has many components. Please be sure you have them all before starting your installation.

COMPONENTS:

- 1) Wire Harness W Switch Box
- 2) Leg and Mount Assembly (L/R)
- 3) On-board Computer Module
- 4) Proximity Sensor
- 5) Saddlebag Mounted Compressor System with Tank
- 6) Hardware Bag

If you believe you are missing any parts, please contact Chopper Design at 407-834-5007, and we will rectify the situation. Some of the parts are shown below.

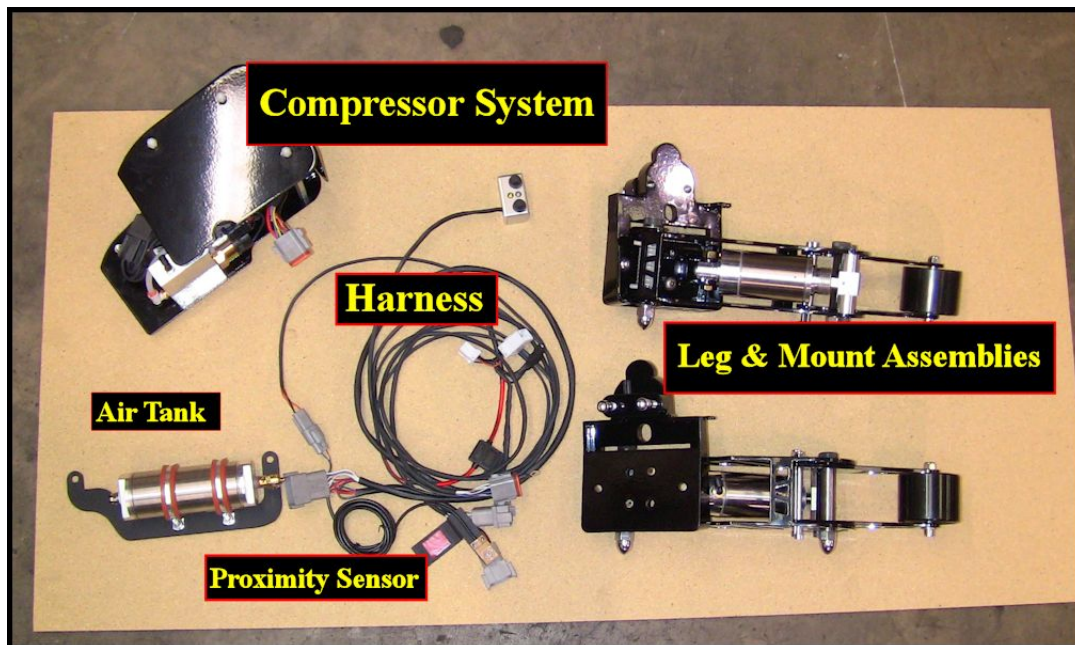

PREPARE FOR INSTALLATION

Place the motorcycle on an acceptable bike lift. You will need to keep the bike on its wheels for most of the installation, and jack the front wheel off the lift for some portion of the installation. Make SURE the motorcycle is secure on the lift!

Remove the seat and both passenger floorboards; they are not needed until the very end of the installation. The Center Stand **MUST** be removed as it will be impossible to access once the wheels are installed.

This manual is available at <http://landinggear.com/pdf/g2installgl1800-2.pdf> . It may be easier to see some of the pictures in color there!

*The GL1800 has many covers and pieces that need to be removed and/or reinstalled during this installation. While we have worked diligently to make this manual very thorough for the installation of your new LegUp system, we **DO NOT** cover all of the details on how to remove and reinstall some of these parts. Please consult a service manual or a qualified technician to help with these items if required!*

Due to the fact that the new GL1800 is so wide, we needed to make the legs longer than any other bike. Due to this, if the legs are up, saddlebags lids will rest on the legs if they are fully opened. The dark part of the lid will touch the legs. You can manually move the leg down to reduce the rub, but no damage should occur.

We are now ready to begin!

CONTROL SWITCH BOX

The switch box should already be mounted to a black mounting plate. The switch box mounts above the right switch housing by a single bolt. Remove the bolt from rear of the switch housing, and set aside (not used again),



Using the bolt provided, slip the bolt through the black plate and spacer (Blue Loctite please), and then thread it into the switch housing. This bolt needs to be snug as when the buttons are pressed, we don't want the housing to pivot on the bolt (picture left). Square the box before tightening the bolt. Route the wire down the handlebar (we removed the wire cover on the handlebar, but you can run the wire outside if you like) and leave it loose near the top of the front forks to be routed under the seat with the proximity sensor wires.

At this point we need to find the proximity sensor & bracket and get the plug off the end. The wires from this sensor need to be routed from the front right fork area, up toward the handlebar, to join the wires from the switch box (See right picture below). Notice we have the bracket mounted under the fork bottom; we left some slack for service of the wheel and tied the wire to the brake line, all the way up and through the center of the bottom of the fork to meet the handlebar wires (we will discuss mounting the sensor later, for now leave it dangling where it is).



Here is the fun part! We use a welding rod, but you may wish to use a coat hanger. Do whatever you have to do to feed the rod from under the forks to come out near the left frame rail (see pics next page).

Now you can remove the wires from the plug on the end of the switch box wire (if not already done for you!), join them with the 3 wires from the proximity sensor, and tape the silver plugs to the rod you just fished through the bike.

Gently pull the rod and wires through the front fairing area until the wires appear (picture below left). Carefully pull on the wires, making sure they move easily. If not, there is a bind, pull the wires and rod back out and start over (Sorry!). Once this works out, carefully remove the tape to expose the silver pins. Route the wires carefully under the metal bracket above the fuel pump to protect the wires (right below). Make sure the wires under the fork have enough room to allow the bars to be turned and that they don't get caught on anything.



Once this works out, carefully remove the tape to expose the silver pins. Route the wires carefully under the metal bracket above the fuel pump to protect the wires (right below). Make sure the wires under the fork have enough room to allow the bars to be turned and that they don't get caught on anything.

The next step is to reassemble the plugs. Use the diagrams on the next page for the switch box, and the proximity sensor. Be very careful to make sure the wire colors all match those in the mating plug and the diagram. The Proximity wires are different on each side of the plug.

More mistakes are made here than on any other part of the install! Now onto the rest of the wiring harness!



Pin Out for Handlebar Control Box And Proximity Plug

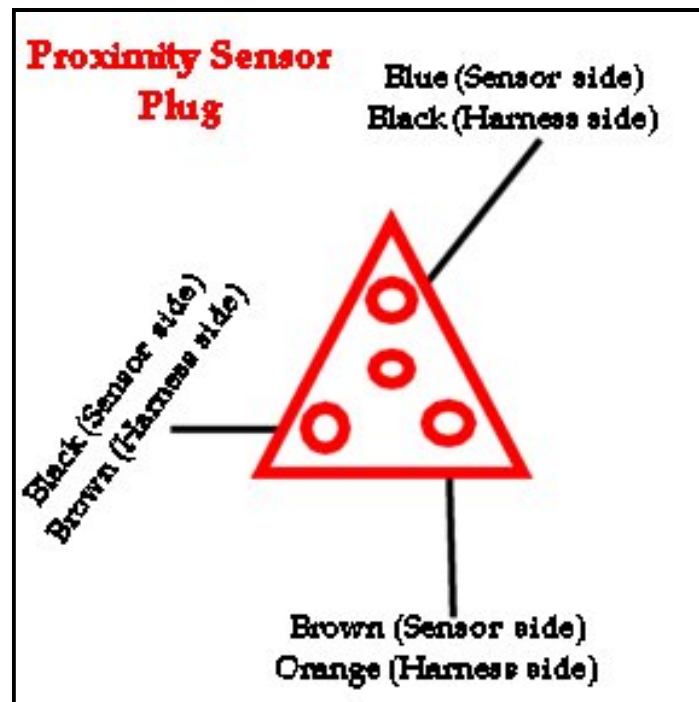
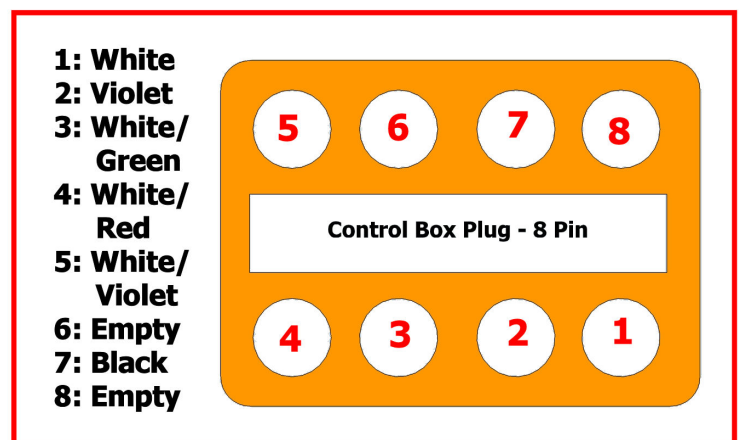
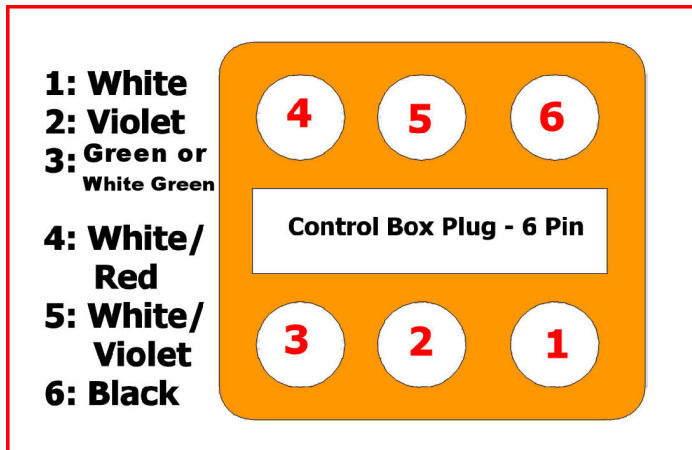

Due to global distributions problems, we may have to use a four pin plug instead of a 3 pin plug. The colors still need to be the same across the plugs with pin 4 empty!

WIRING HARNESS

The next step is to route the wiring harness. The harness and the plugs are routed mostly under the seat and into the right saddlebag.



First, we need to remove a total of 4 bolts from the right saddlebag to get it loose enough to allow us to run the wires. The three pictures show where the bolts are (3 inside the bag and one outside). We also remove the right passenger hand rail for access.

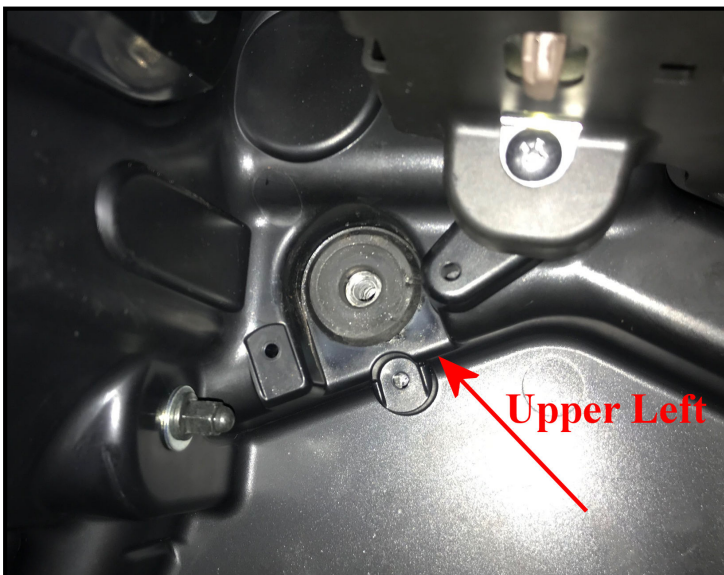
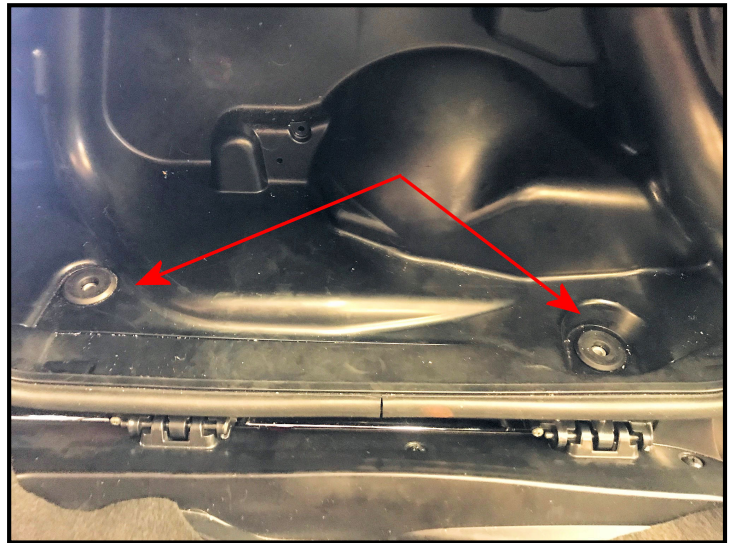

Find the Interconnect Harness. It has a 12-pin and an 8-pin plug on one end and 12 silver pins on the other. On the next page, we are going to route this from the right saddlebag, under the seat.



Carefully route the 12 silver pins through the hole seen at left after removing grommet. This hole is upper right of saddlebag. Carefully pull the saddlebag away from the bike some, and find the hole (below, right).

Work the pins through the hole and carefully pull them through the hole, under the frame rail as seen below. Work the wires under the seat.

At the same time, we need the 2 air hoses. We want to push those from the saddlebag the same way, and get them

under the seat area as well. Make sure they don't bind on anything. We will decide how much line should go back into the bag later.

We have routed the wires safely inside the frame rails as you can see below.

Once the pins and hoses are under the seat, we can reassemble the twelve pin plug, and just leave the air lines dangling for now.

(See 'Illustrations' toward the end of this manual for diagram. IT IS CRITICAL that the plugs are assembled per the illustrations for future support!!!)

Once the plug is assembled, we will pull the harness back into the saddlebag so we will have enough slack to install the compressor system. Later we will show you this.

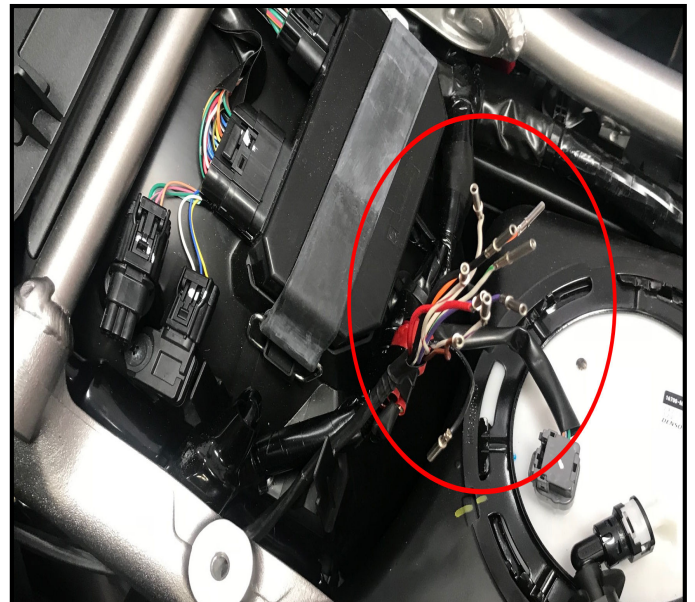

Find the proximity sensor; it should already be dangling near the left front fork.

NOTE: We will mount this bracket in this area later, but making sure you have enough wire to mount it and that the extra slack is pulled to the under seat area!

Make sure the wire is clear of everything, bearing in mind that you need to leave some slack to allow the suspension to move up and down. Once you are satisfied, plug in the proximity sensor with its' mating plug. Make sure the eight pin plug from the switchbox is plugged in as well.

Next we need to route 2 sets of wires to the left side cover area. One has two hoop connectors with an Orange and a Black wire (**On later harnesses, the Black wire is eliminated**), the other has two thicker wires, Red & Black, one has a fuse holder and both have round connectors for the battery terminals. These need to find their way into the left side cover area. Looking at the picture

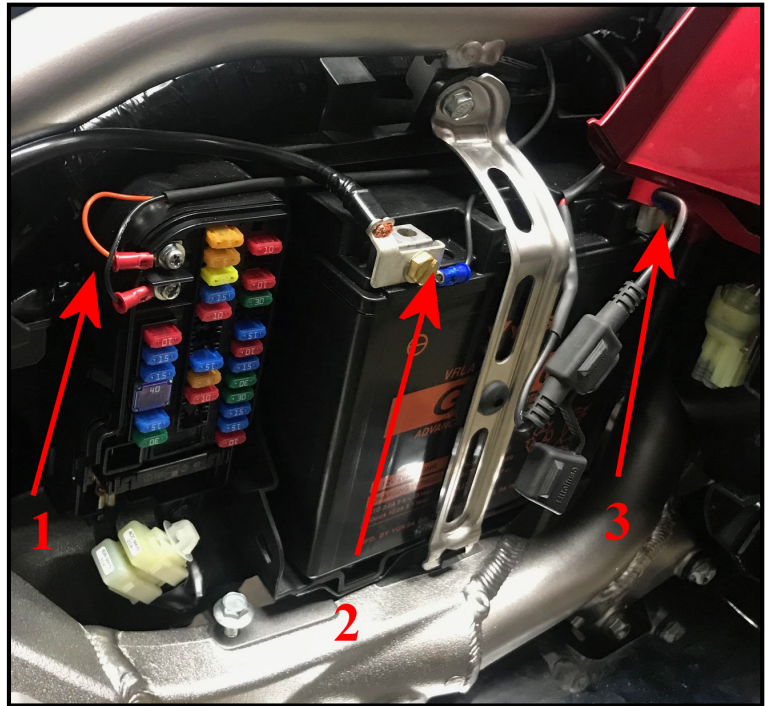

at right (fuse box cover is removed); (#1) is the two hoop connectors that are orange and black. Using a Phillips head screwdriver, remove the top screw, and attach the orange wire to this post. The black wire (If present) gets attached to the lower post. Notice that the wires can be routed

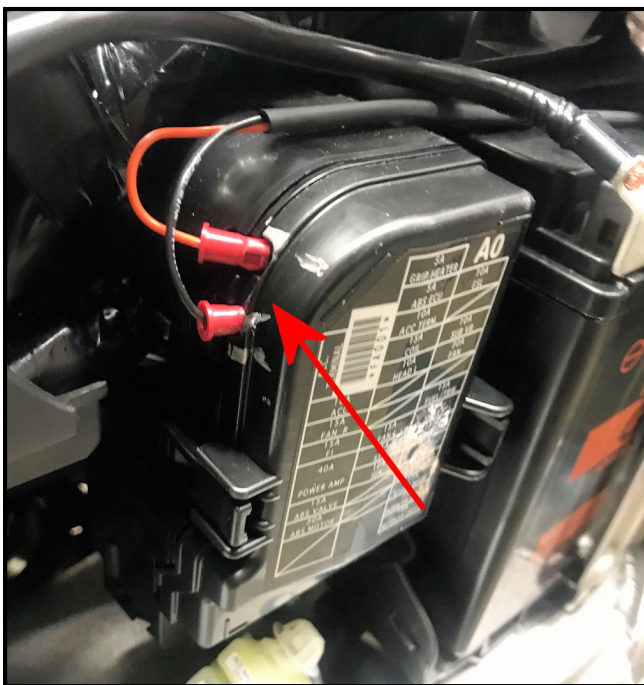

out of the fuse box to the left where there is a relief for each. We strongly recommend that you replace the existing 10Amp fuse (third one down middle row) with a 15 or 20AMP fuse. This fuse only supports the orange wire here and to be safe, another 5 or 10amps worth of fuse is just a good idea. These connections are only on when the bike is either on or in accessory mode.

The other wires attach directly to the battery. The one with the fuse holder (#3) is attached to the positive post (we suggest removing the fuse for now!), and the black wire (#2) to the negative. These power the compressor through a relay! Notice the route of the wires underneath the frame rail.

We notched the fuse box cover to let it close easier. Pull all extra slack under the seat. All these wires will be cleaned up and tied off later. On to mounting the legs!

LEG & MOUNT ASSEMBLIES

Now we need to mount the Legs under the passenger floorboards. We need to remove the side cover above the floorboards and the silver covers above/behind the passenger floorboards (right side shown here). The right picture shows the top bolt, and the left one, the small bolt below that holds these covers. There is also a plastic pin that just pulls out to get these covers off. These silver covers will not be re-installed.

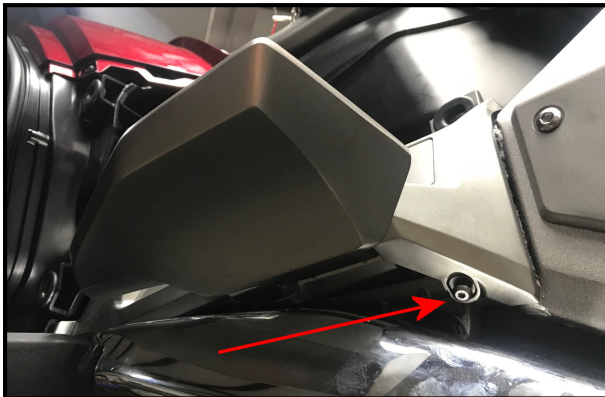

Next we remove the floorboards by removing the two bolts that holds them to the bike (picture next page). Carefully unscrew the 2 bolts, and set them aside as we are going to use other bolts to mount these to our leg assemblies.

Next, find the leg assembly for the right side (either side first), and find the M8X50 Hex bolts. Put one through the front hole at the bottom of the leg mount,

then through a $3/4$ " and a $1/4$ " aluminum spacer, and start it threading into the front frame hole (a bit of blue Loctite here!). Use another bolt, through the rear slot, then a $3/8$ " spacer into the rear frame hole as well. These bolts are long and the assembly is heavy, so a helper is a nice thing to have here. Slowly snug up the two bolts until they are very tight! Give a tug, they leg should be part of the bike.

Repeat this process for the other side.

Next we want to mount the floorboards to the mount you just installed.



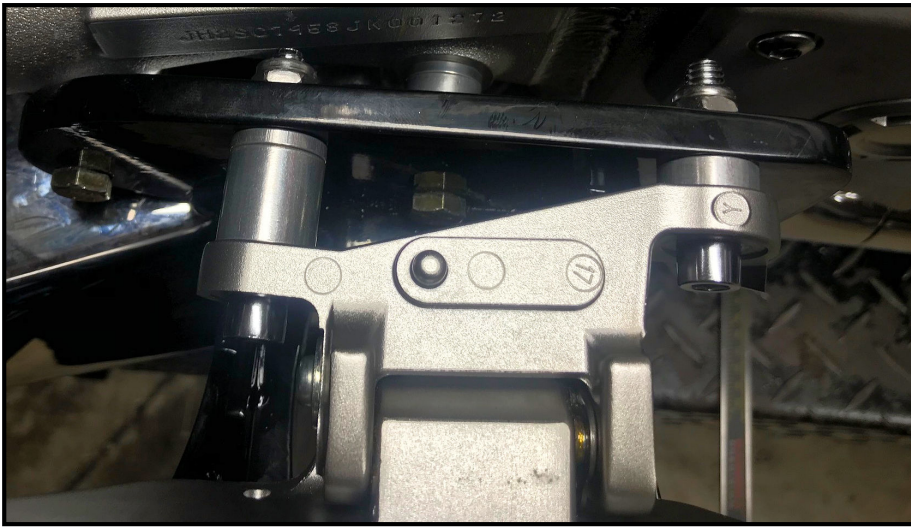

Using a 1 1/2" Allen bolt for the front and a 2" Allen bolt for the rear, put the bolt through the rear, then a 1/4" Spacer and through the front, then a 5/16-18 locknut on the bolt. Do the same for the rear except the spacers are 3/4" and 1/8" long. Tighten the bolts and nuts and the floorboards should be good to go!

See additional pictures below.....



Due to the fact that the new GL1800 is so wide, we needed to make the legs longer than any other bike. Due to this, if the legs are up, saddlebags lids will rest on the legs if they are fully opened. The dark part of the lid will touch the legs. You can manually move the leg down to reduce the rub, but no damage should occur.

Let's run the air lines!

RUNNING AIR LINES



We need to route the air lines to the cylinders; this way we can protect the excess, and ultimately pull that excess back into the right saddlebag.

The air lines have should be lying where the seat would be. Run them carefully toward the legs. You need to make sure the lines will not be crushed or damaged anywhere you put them.

Here we ran the line above the silver frame rail, down between the spacers attached to the floorboards, and down through the hole in the mount (bottom Picture) and pressed the line into the fitting on the cylinder.

Once the line is installed into the fitting, give it a small tug, to make sure it is in the fitting tightly. Then manually run the leg up and down to make sure the line is fine where it is.

Once this has been accomplished, go to the saddlebag, find the line that runs to the leg you just worked on, and pull the excess line back into the saddlebag. We will tie the excess off later; don't cut the hose! We want the lines to be the same length so the legs fill at the same speed!

Repeat the process on the other side of the bike. The right one will have more slack than the left.

One the next page we have examples of how to get the lines out on each side.



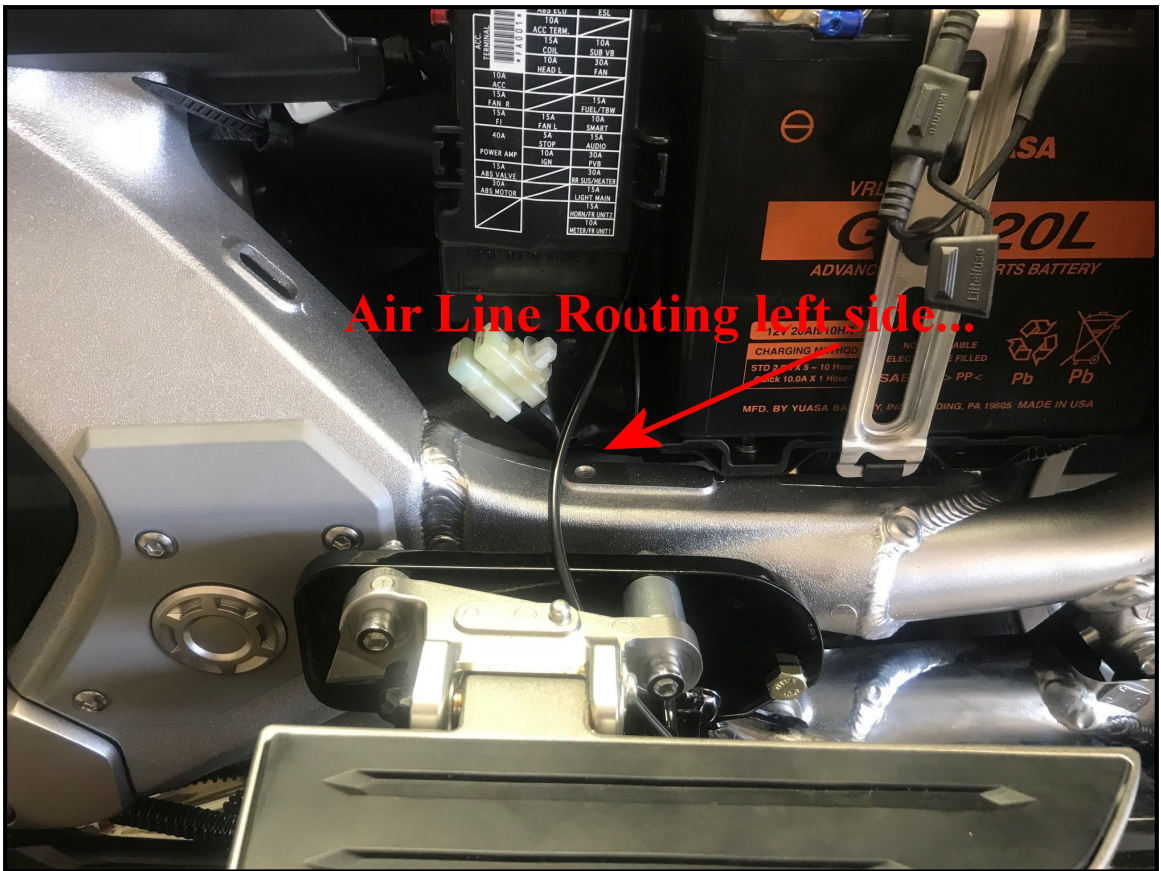
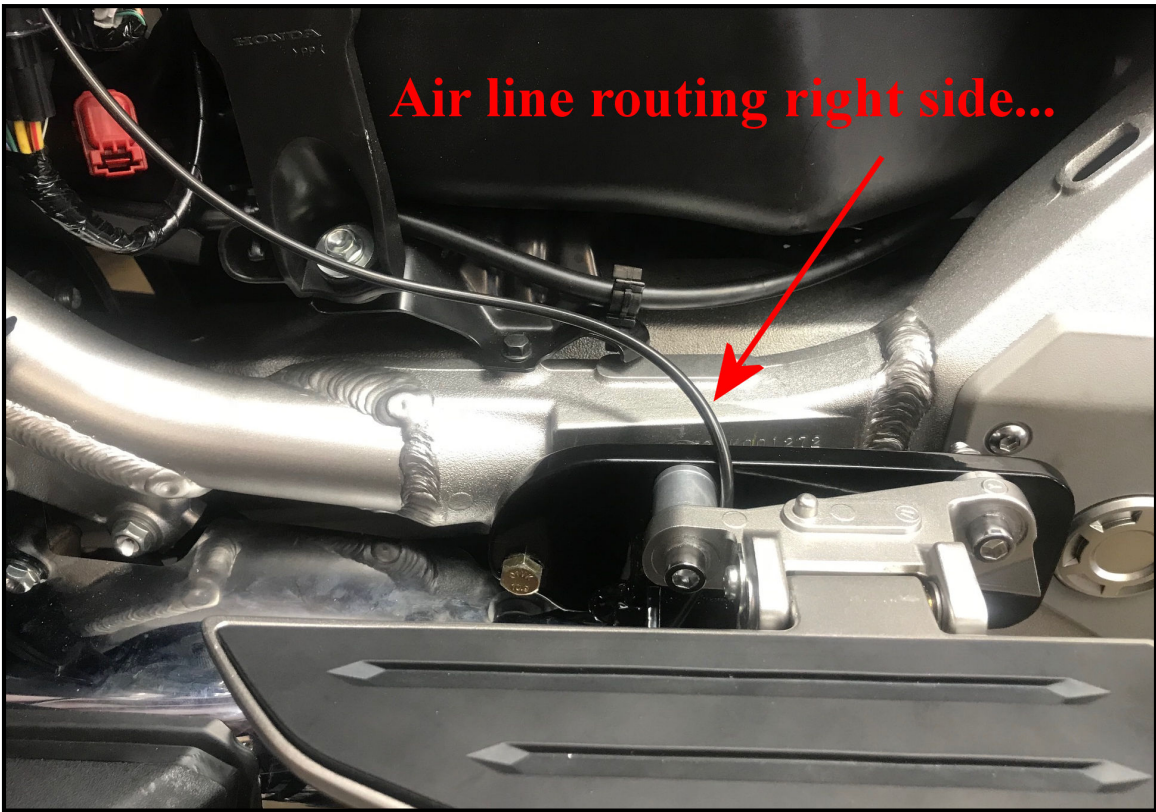

Let's install the compressor!

INSTALL THE COMPRESSOR

Find the compressor, as shown here. We will need put the computer on the top plate and offer the entire system to the right saddlebag.

Before we actually install the compressor in the bag, we need to connect the air lines and two plugs.

We set the compressor on the inside of the saddlebag lid and connected the air lines (#1), the 8-pin plug (#2) that is attached to the compressor, and the 12-pin plug (#3) from the computer, just as shown below.

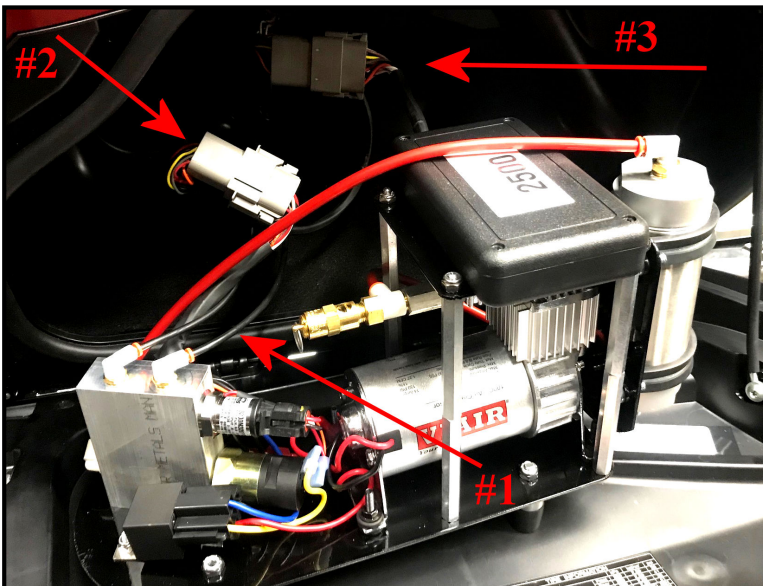
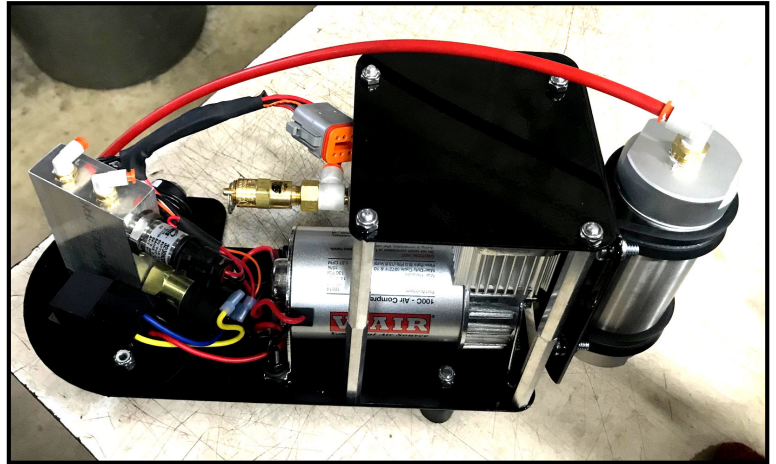

The excess air line should have been pulled back into the bag, as well as the extra wire harness length.

We next can install the compressor, making sure the lines and the wires will fall harmlessly behind the left side of the compressor.

Slide the compressor in, tilting the top toward you and find the spot all the way toward the back where the shape of the compressor base falls perfectly into the

shape of the bag.

Once complete, it should fit perfectly as should at right.

See additional picture on next page.

We are about to do some initial system testing so make sure that the negative terminal of the battery is connected, and the fuse holder we installed has the fuse in it!

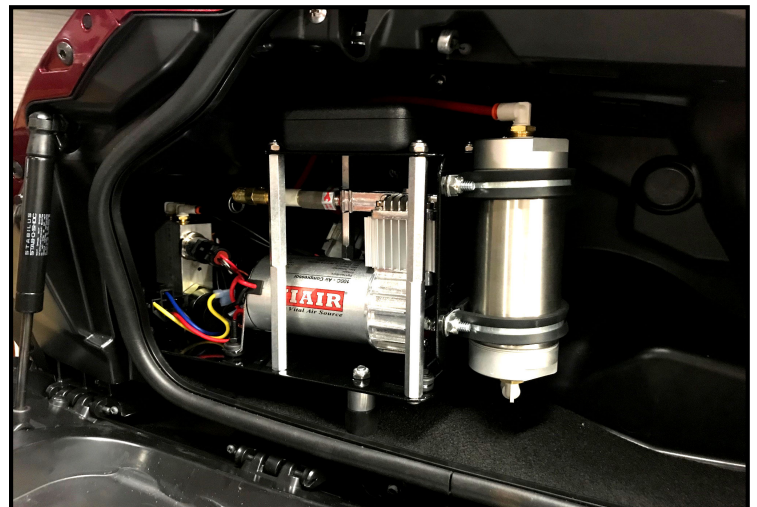

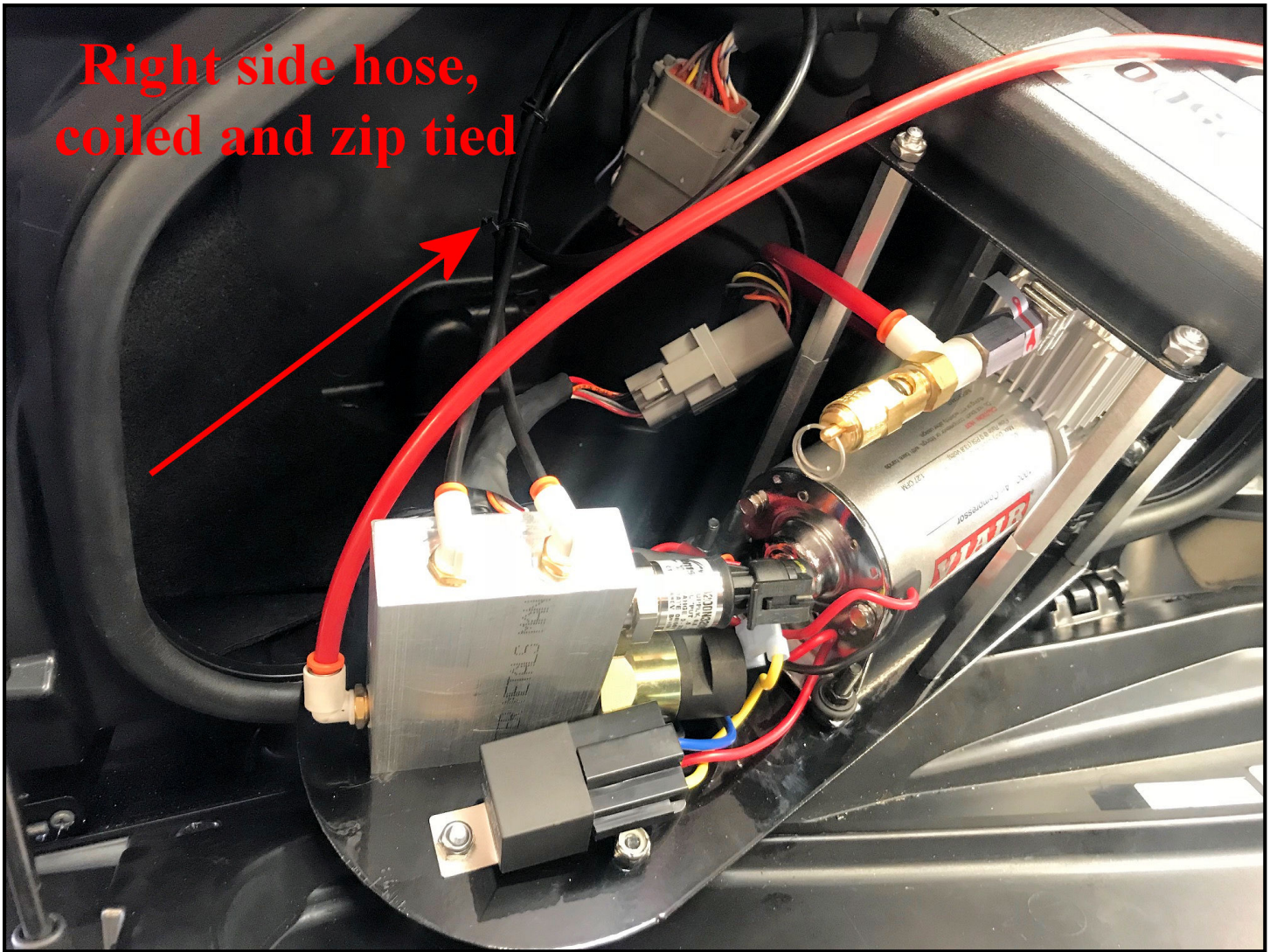

Right side hose,
coiled and zip tied

Coiled excess hose before final installation of compressor!

INITIAL SYSTEM TEST

Turn your bike to *Accessory Mode*. This is all the way to the right on the key on the GL1800. The screen on the dash should light up, and if everything is working properly, the compressor should turn on for about 6 seconds to fill the onboard air tank. At this point, have a look at the yellow proximity sensor.

PLEASE NOTE: Immediately after turning on your bike (within 5 seconds), the top light on the handlebar control will flash for a few seconds. This is the system either making sure that no air is in the legs if they are up (for safety it makes sure air does not build up when the legs are in the up position), or that the proper amount of air is in the system if they are down (again for safety to make sure the legs stay pumped completely!). This test occurs once a minute for all the time the bike is powered up, whether you turn the LegUp system on or not!

The **RED LED (ON The Sensor)** ***Should Not Be Lit***. Take a metal object (screwdriver, wrench, etc.) and hold it on the flat face of the sensor (it has a circle embossed in it). The LED should light up, and go out when you move the metal away. If not, check all your connections.



Next, press the rightmost pushbutton on the handlebar switchbox, and hold it for at least 3 seconds. Both LEDs on the switch panel should light up; green means the legs are up and yellow means the bike is traveling under 6MPH. If this occurs, you are doing well.

The next step requires some care. If the bike is still on the lift, have a helper hang on to it as you touch the left button for just a split second. The legs should move down, likely until the wheels hit or miss the lift, and they do this **VERY** quickly! The compressor will likely start and run for about 10 seconds. Press the left button again and they should move up.

If all of the above has occurred, great! Turn the ignition switch off, the test is complete!

Let's move on to mounting the Proximity Sensor.

MOUNT PROXIMITY SENSOR

This step is crucial!! Understand it before starting. The proximity sensor tells the system how fast the bike is traveling. The proximity sensor mounts to the bottom outside pinch bolt of the right front fork. Remove this bolt, install it through the bracket Then the 3/8" spacer and reinstall the bolt semi-tight, so the bracket can be moved if need be (a little Loctite please!). You need to jack up the front wheel or have the bike on the ground so we can spin the front wheel to test the sensor and its placement. Make sure the bike is in neutral.

The sensor will track the rotor bolts on the front wheel as it spins, and is to be mounted 5MM away from the bolts or closer; like the picture below. Once the bracket is mounted, turn the key

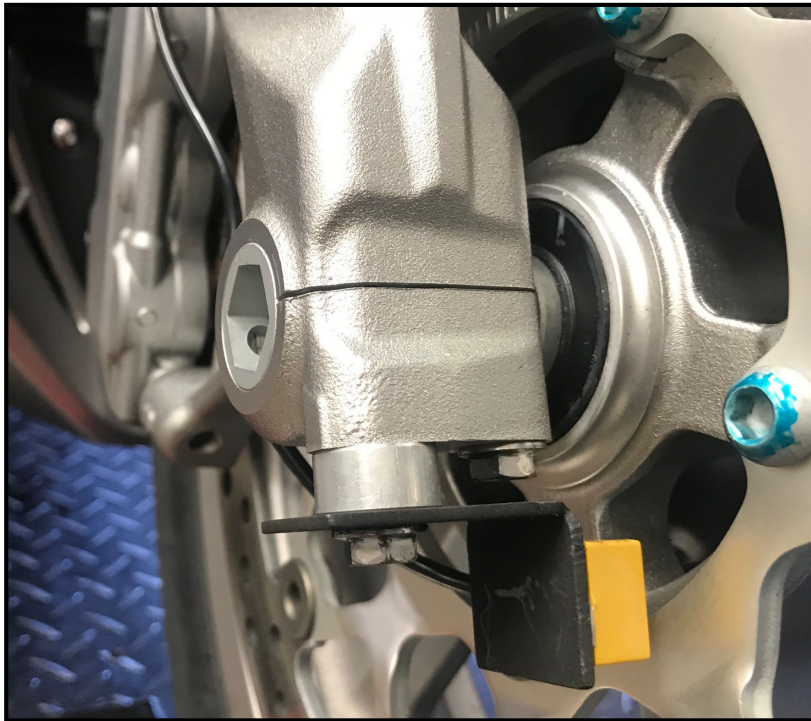

to the accessory position, spin the wheel or roll the bike and watch the behavior of the sensor as the bolts pass it.

The LED on the sensor should be off when no bolt is passing the sensor, and the LED should light when a bolt passes by the sensor. Play with this by rotating the wheel back and forth while adjusting the bracket in, out, left or right until the light blinks consistently.

Once you feel you have the right place, tighten the bracket down and slowly rotate the wheel. Every time a bolt passes, the light should get bright when the bolt is nearby and off after it passes.

If this is not happening, you may need to get the sensor a bit closer to the bolts (5MM is a very small distance!). If you have to move the sensor closer, just loosen the bolt again, and re-adjust the sensor. No matter what you need to do, you **MUST** make sure that as the wheel turns, the light works as described above! Once you are certain, tighten the bracket down very firmly! Re-check that everything functions properly by spinning the wheel past all 6 rotor bolts and verifying that the LEDS changes as described above. The automatic retraction of the legs as well as their deployment **RELIES** on this sensor being placed perfectly!

Once satisfied with the mount, make sure the wire running up the fork leg is tied off, clears everything, and can't get damaged by anything.

WIRE ROUTING

Now we want to tidy everything up. Under the seat, we have quite a bit of excess wire, so you should get the plus into a safe spot (Arrows), and wind up the extra wire and tie it up with wire ties. We made this loop you see, and put it under the wire from the fuel pump. This way we know the seat will not disturb the wires.

This would be the perfect time to make sure the air lines are tied off softly and will not contact anything that can harm them.

Let's start finishing up!

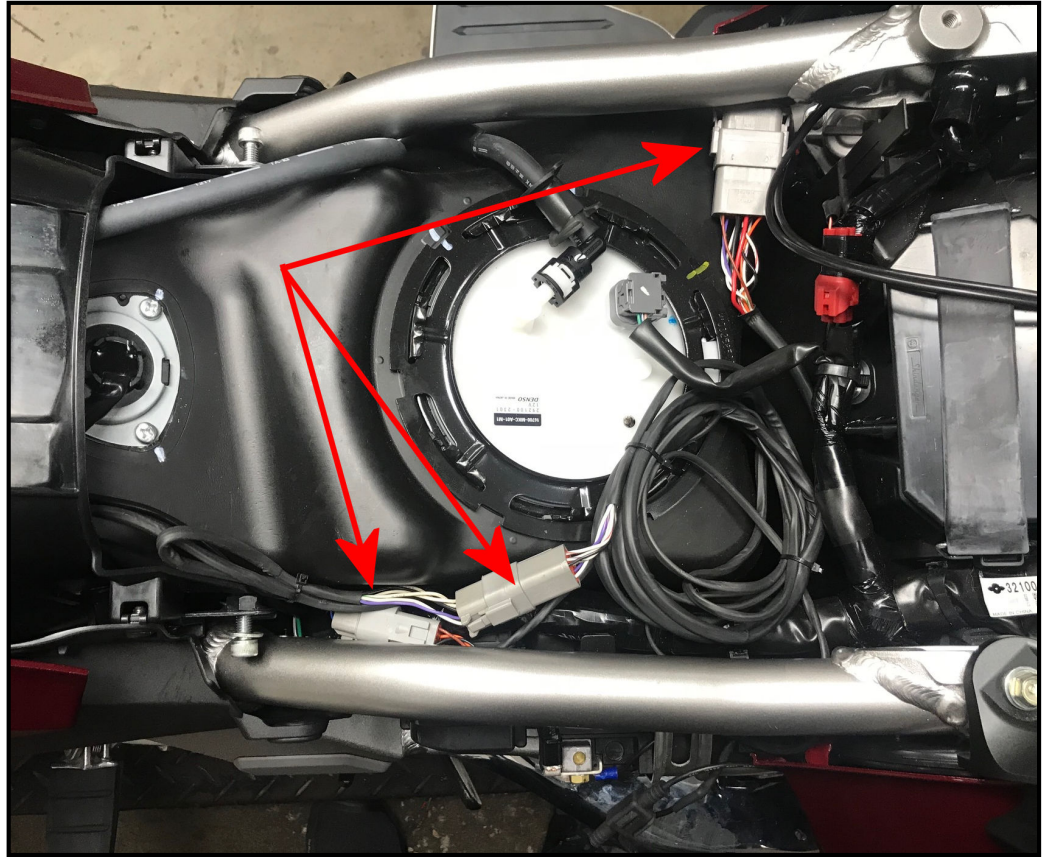

FINISHING UP

Now it is time to reinstall everything you took off, and do final checking of everything! Reinstall the seat making sure all your wires are routed neatly, tied off nicely and don't interfere with the seat installation. Make sure the mounting bolts for the right saddlebag have been reinstalled. Side covers go back on making sure the wires to the battery and fuse box are neatly stored, and the air lines are not in any sort of bind!

Once all of this is accomplished, we should get the bike on the ground, and with a helper, cycle the wheels up and down manually a few times, having your helper make sure the air lines are not being scuffed or are over tight, and that the lines are out of the way of anything that could damage them. Double-check all your bolts for tightness. Now we can dial in the legs, and adjust the wheels if needed.

LEAKS!

This system uses air, and air loves to leak! The fittings we use are tested for leaks before shipping, but we have a few simple tests to make sure you have no leaks or just insignificant ones if any.

Set the wheels down and leave the system on. Put the kickstand down, and turn the bars all the way left.

If the compressor makes noise more than once every two minutes, you may have a leak at the lines that connect to the compressor or the tank fittings. Some soapy water will tell you where (you will need to remove the compressor top to test for these leaks).

Assuming the compressor doesn't lose enough air to kick on after 2 minutes, you should be fine.

You can turn the bike off, and wait to see if in 5 minutes the bike is not as stable as it was when the wheels were first lowered. If it lasts the 5 minutes and is still very stable, you could still have a leak, but not one that would be a problem on the road!

Leave the bike on its wheels overnight (again kickstand down, bars full left in case the legs lose a lot of air; the bike will land on its stand). If in the morning, the bike is still stable you have no leaks.

If there are leaks, the fittings on the air cylinders would be the first for the soapy water check, with the two small line fittings on the compressor next! If you need help with these, please feel free to call us at (407) 834-5007.

FINAL ADJUSTMENTS & MAINTENANCE MODE

The next two sections are typically **NOT** needed. We include them to document your system thoroughly, but **MOST** people will never need to use either section.

MAINTENANCE MODE

NOTE: Maintenance mode is a procedure that ‘TEACHES’ the computer how much pressure to use when it lowers the wheels and how much pressure to release when raising the wheels. We always set this at the factory; ALWAYS!! We include this procedure in case it is ever needed in the future. Please skip this section unless you have been instructed to reset the system by Chopper Design.

Turn the ignition to Accessory and start the LegUp System (hold right button for 3 seconds). The system should be set at the factory for proper pressure, but some wheel adjustment may be needed. If it has been determined that ‘**Maintenance Mode**’ is needed, Sit on the bike, and hold it level. If both lights on the switch box are flashing, the system is in maintenance mode. If not, **PRESS & HOLD** both buttons until all lights flash. ***(Do your best to press both buttons at the same time so the system doesn’t respond to what it thinks is a request to lower the legs)*** Once flashing, hit both buttons for an instant to get the system in the ‘**DOWN**’ setting mode (lower, yellow LED flashing). Touch the left button briefly; the wheels should go down immediately. ***(This is VERY quick, don’t be startled!)*** Using very short pushes of the left button, press and then feel the stability of the bike. If it feels firm enough, try leaning the bike a bit. If the wheels return the bike to upright, there is likely enough pressure. Put your feet on the floorboards; the bike should stand on its’ own. Rock the bike a bit left and right, being prepared to put your feet down. If the bike continues to come back to upright, the **DOWN** stop is now set and we can move on.

Hit both buttons for a moment to get into the ‘**UP**’ stop mode (Usually hitting the left button just before the right assures that air is not released!) The top LED should now be blinking. Press and hold the right button to raise the legs. Listen as the air evacuates; once it is quiet, let go of the right button. The **UP** stop is now set! Hit both buttons when complete, Both LEDs should light, and you are done with these adjustment.

Now press the left button and the legs should lower; again this is fast and loud. The bike should be held up firmly! Hit it again and the legs should retract. If you are satisfied with these limits, you have successfully installed the LegUp System.

WHEEL ADJUSTMENT

The LegUp GEN II system is typically set up at the factory for the height of your bike. The system is VERY height dependent! If after testing the initial installation, the bike does NOT feel stable, the wheel system MAY need to be adjusted to the height of your bike. AGAIN, we normally ask at order time if your bike is at stock height and we set the system up for whatever height you have furnished us. DO NOT make any changes unless the stability we expect is NOT present! If you feel you need to adjust the height/length of the wheel holders, please read this ENTIRE section before starting the process. If you need help, please contact Chopper Design at 407-834-5007.

If you are happy with how stable the bike feels, you can skip this section, and move on to a test ride! If you are not sure, or you skipped **'maintenance mode'** as instructed, a good test is to bring the wheels down, put the kickstand down, and lean (or try to) the bike on its kickstand while sitting on the bike. If the bike comes back to center without your help, or you put your feet on the boards and can bring the bike up by just leaning to the right; move on to the next section (Test Ride), the wheel settings are fine!

The stability of the GEN II LegUp system, relies on the pneumatic actuator, when deployed, being at an angle that is forward of perpendicular for best results! Different bikes are at different heights, and Chopper Design uses an ingenious method to adjust the length of the supporting legs to maximize the stability it affords.

Typically, we will send the 'Leg Assemblies' set up for perfectly for your bike. In the event your bike is at a different height than stock, the information and adjustments that follow may be required.

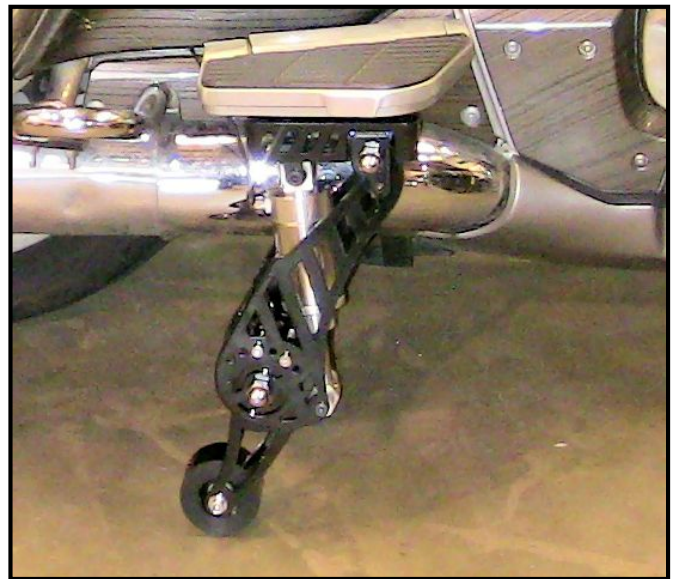

PLEASE NOTE: The GEN II system is bike height sensitive, and Gold Wings can sink when loaded two up. You should test the stability of the system with a passenger and adjust the air shocks to stiffen the suspension and get the stability you have here with a rider. You may need to re-adjust the shocks for solo riding as well.

On the next page, we show you the wheel holders which should help clear up any confusion you may have about the wheel holders and their adjustments.

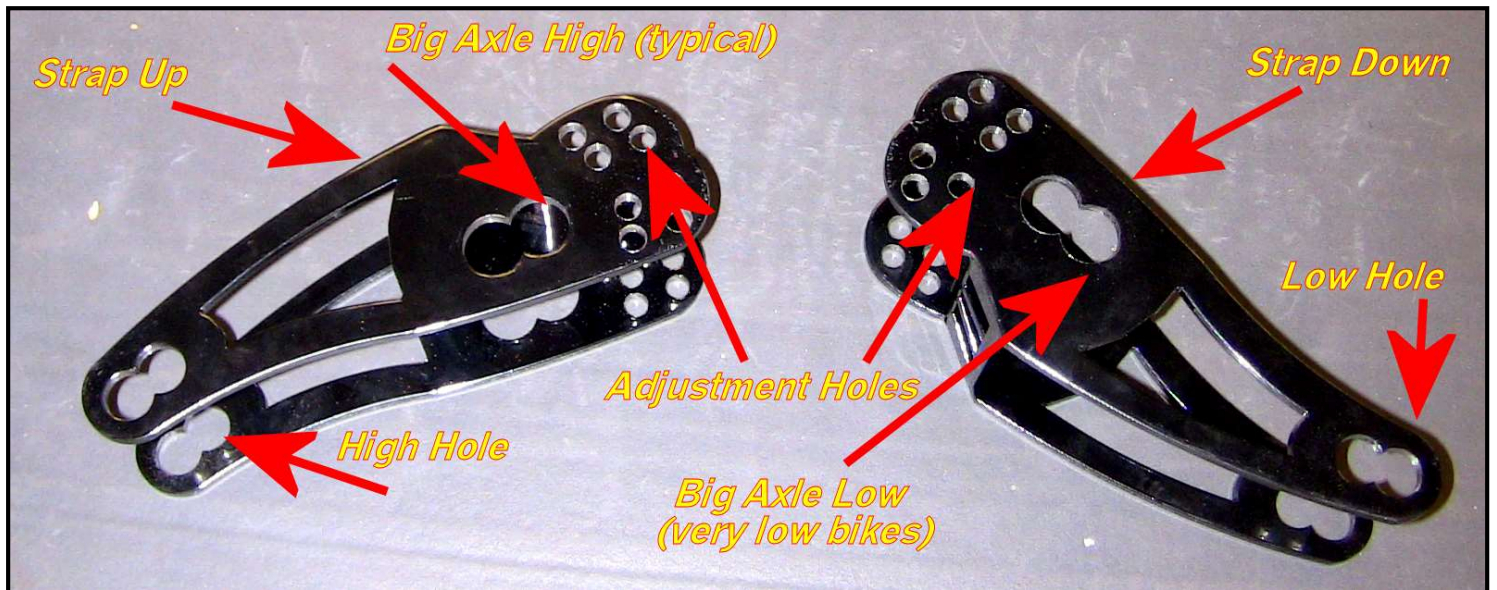

On each supporting leg, you will find two bolts down near the end by the wheels. The two bolts control the angle of the ‘Wheel Holders’. By moving the wheel forward or back, we can tailor the length of the support arms to a particular bike.

A helper is handy here. Make sure the wheels are up. Make note of exactly which two holes the bolts are in. Loosen the locking nuts from the back and remove the bolts; you will notice the ‘Wheel Holder’ can pivot on the big axle bolt. Starting on

the left side of the bike, move the bolts one hole counter-clockwise. Go to the right side and move them one hole clockwise. Loosely fit the nuts (no need to final tighten them at this point).

Lower the legs. Is the bike more or less stable? If it is more stable, and you can sit on the bike and rock it back and forth without it leaning over you are done. If not, remove the bolts again, and move them in the opposite direction two holes, and retest. If everything is fine, final tighten the lock nuts and you are done.

If you need to, you can move the wheels from the lowest hole, up one hole. You can remove the wheel holders, turn them over (strap up instead of down for example) and install them on the other side of the bike. You can move the big axle from the low to the high hole. All these techniques take patience, but allow significant flexibility to tailor the system to your bike. On the next page we show you some examples. Normally you do not need to do **ANY** of these adjustments, but if you need to, we wanted to teach you the methods at your disposal.

TEST RIDE

PLEASE NOTE: Immediately after turning on your bike (within 5 seconds), the top light on the handlebar control will flash for a few seconds. This is the system either making sure that no air is in the legs if they are up (for safety it makes sure air does not build up when the legs are in the up position), or that the proper amount of air is in the system if they are down (again for safety to make sure the legs stay pumped completely!). This test occurs once a minute for all the time the bike is powered up, whether you turn the LegUp system on or not!

Get the bike to a clear paved mostly level area where you can test ride it. Start the bike, turn on the LegUp system and lower the legs. The first test should be done in a straight line. Put the bike in gear and slowly accelerate. You may notice that the bike tends to want to steer a small amount left or right. This is normal unless it is severe. Effectively, you are driving a trike, and steering is done with the handlebars **NOT** by leaning. Once underway, (we recommend you keep your thumb near the left button, and press it to raise the wheels if there are any surprises) the top LED should flash at around 6 MPH, meaning the legs are retracting. It is difficult to lean on one wheel or the other as you leave, so you may wish to raise the wheels manually if the bike is steering due to uneven pavement.

Assuming the legs are retracted, you should try to deploy the wheels. As you come to a stop, the Green LED should be on. As you slow down (**almost stopped**), the Yellow LED should illuminate at the proper speed. Once it does (sometimes hard to see), hit the left button and put your feet down near the ground. The top LED should flash and the wheels should deploy almost instantly underneath you! Make sure you are ready to balance the bike, though you likely won't have to! Immediately after the wheels touch the ground, the bike should be supported reasonably, but the cylinders can take up to 6 seconds to get completely filled. Make sure you balance the bike as this occurs. The slower you are going when deploying the wheels, the smoother the transition will be from wheels up to wheels down. Practice these maneuvers until you are comfortable with the wheel adjustments and the system operation.

NOTE: With the system on or off, if the legs are up, the computer will dump the air from legs once every minute that the bike is turned on! This is a safety feature to make sure pressure does not build inside the legs, causing them to deploy! The top light will flash once a minute for a few seconds. This is completely normal, and the left button will be inoperable while this occurs.

SEMI-AUTOMATIC DEPLOYMENT: Another way to deploy the legs is semi-automatically. First we must be **SURE** that the proximity sensor is working properly or the wheels could come down at higher speeds than we wish. If you are travelling at a speed over 10 MPH, AND the yellow light (bottom) on the handlebar control is out, hit the left button. The bottom or yellow LED should start to flash. When you slow down to around 5MPH the wheels will deploy (see the red/green flash on top LED). Again prepare to put your feet down. IF the lower LED is lit at a speed over 10 MPH, don't hit that button; see caution below!

NOTE: The bottom LED Should not be LIT SOLID if the bike is travelling over 10MPH! In the event it is, the wheels will deploy instantly if you try to set them as above; this is dangerous! You MUST re-visit the sections on testing the proximity sensor. You should always be aware that this light should NOT be on if you are traveling at speed, and 'Arming' the system for deployment should only be attempted if the lower LED is Not Lit! Please see the User Manual for more information on Proximity Sensor Failure!

The next thing to try is to make a turn from a dead stop with the wheels down. As soon as you start the bike moving, turns can only be made by using the handlebars. The LegUp system is too strong to allow a great deal of lean with the wheels down! If you need to make a turn shortly after departing from a stop, raise the wheels manually (left button) and you will get complete control again.

The next thing to try is slow speed maneuvering with the wheels lowered. If you keep your speed down, most slow speed maneuvers can be accomplished with your feet up, keeping in mind that at about 6 MPH the wheels will come up automatically! You can try full lock turns in both directions and the bike should stay upright with your feet up.

Understand; it is always a good idea to keep your feet near the ground during these maneuvers if you can. A mechanical failure or a wheel in a pothole could upset the bike.

Because the wheels are right behind your legs when they are down, we recommend not trying to push with your feet to move the bike forward. Use the engine and keep your feet out of the way; this way the legs don't bite at your heels as the floorboard always have! Backing up using your feet works fine and the chore of balancing the bike is taken care of for you.

Practice, practice, practice!! Enjoy your LegUp System!

ILLUSTRATIONS

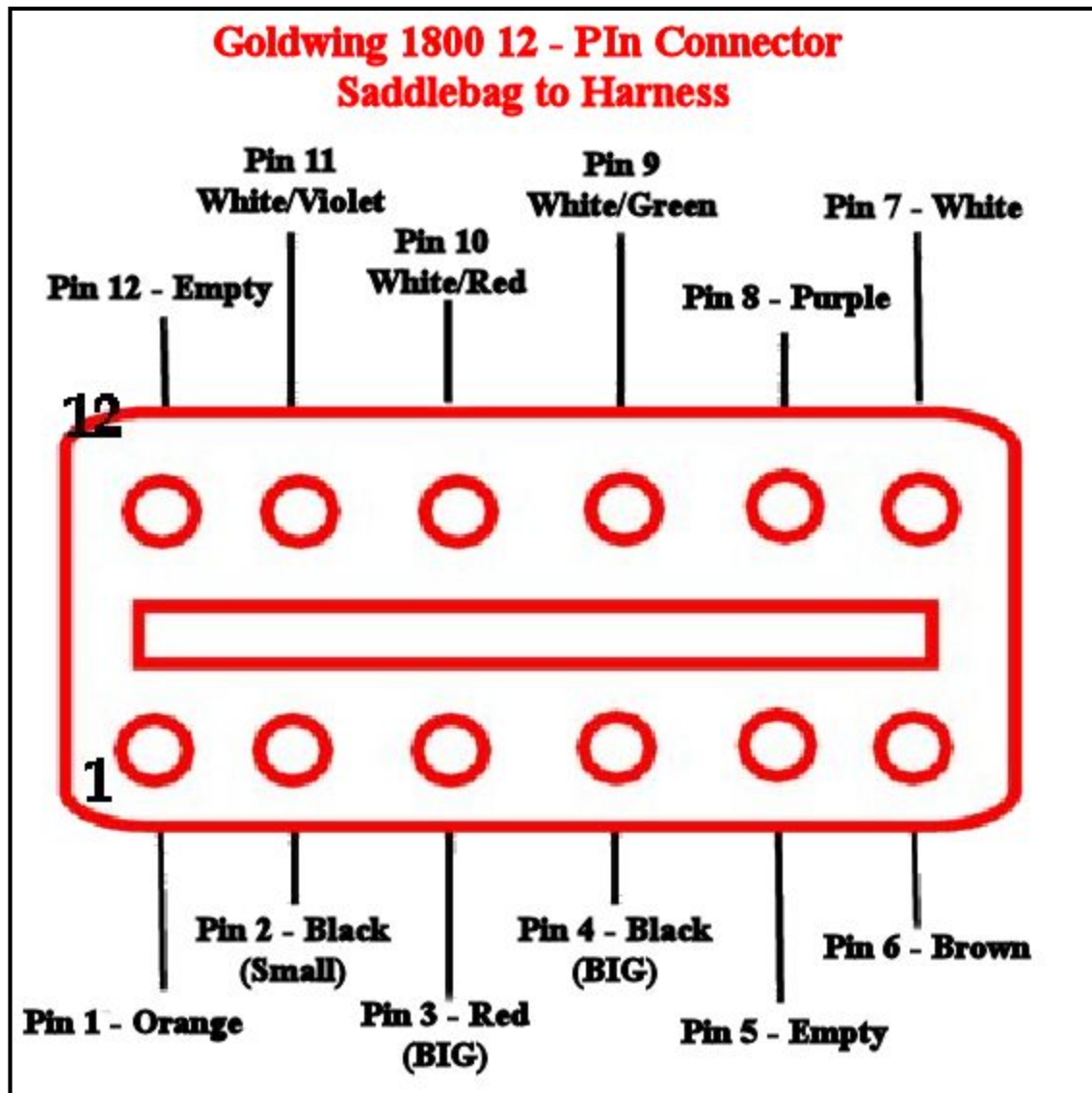

There are (2) 12 pin plugs to be assembled; the Female plug (male pins) from the harness under the seat, and the Male plug (female pins) going through the saddlebag. It is **IMPERATIVE** that you assemble them just this way so if you ever need support, we will know how to help! This could save you hours of aggravation.

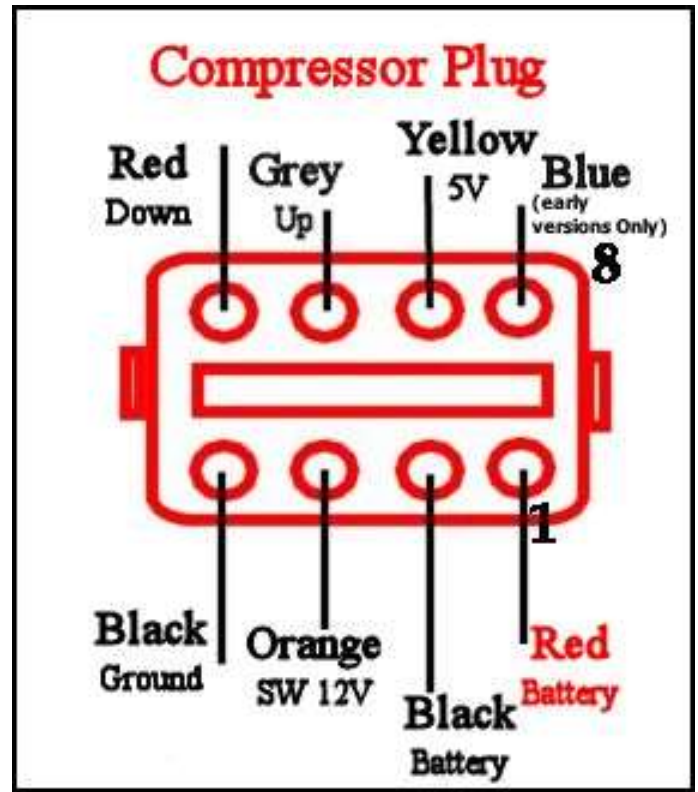
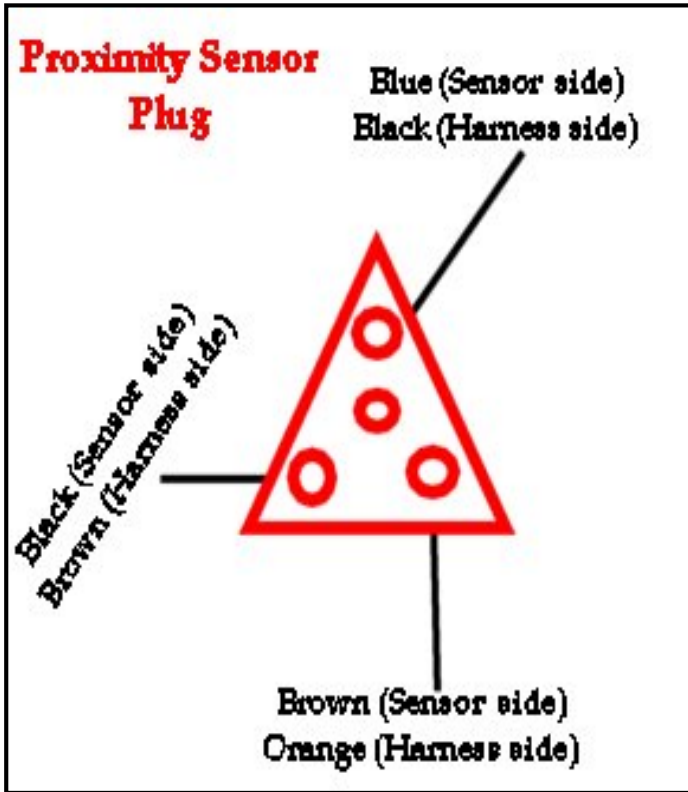

Due to global distributions problems, we may have to use a four pin plug instead of a 3 pin plug. The colors still need to be the same across the plugs with pin 4 empty!

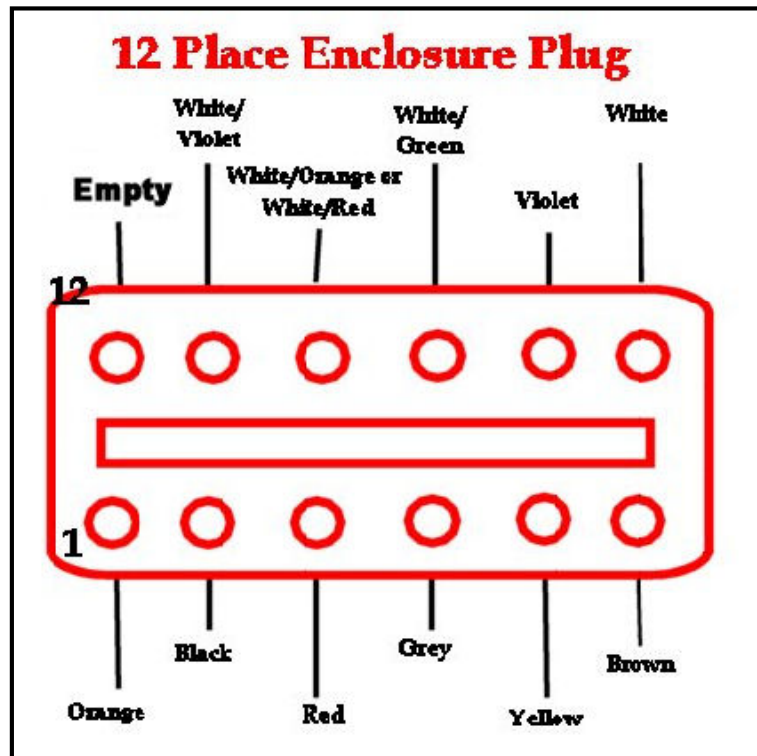

HARDWARE LIST

(4) M8 X 50MM Hex Bolts with Washers (Leg Attachments)

(2) 3/4" X 3/4" X 5/16" Aluminum Spacers (Front Leg)

(2) 1/4" X 3/4" X 5/16" Aluminum Spacers (Front Leg)

(2) 3/8" X 3/4" X 5/16" Aluminum Spacers (Rear Leg)

(2) 3/4" X 3/4" X 5/16" Aluminum Spacers (Rear Floorboard)

(2) 1/8" X 3/4" X 5/16" Aluminum Spacers (Rear Floorboard)

(2) 1/4" X 3/4" X 5/16" Aluminum Spacers (Front Floorboard)

(2) 5/16-18 X 1 1/2" Allen Bolt with Nylock Nut (Front Floorboard Bolts)

(2) 5/16-18 X 2" Allen Bolt with Nylock Nut (Rear Floorboard Bolts)

(1) M5 X 50 Black Allen Head Bolt (Handlebar Bracket through Spacer to Bike)

(1) .875 X .375" Aluminum Spacer (Stock Handlebar Box spacer)

(1) 10-32 X 1.25" Allen Head Bolt (Handlebar Box to Bracket)

(1) 10-32 Acorn (Under Above Allen)

(1) 3/8" X 3/4" X 5/16" Aluminum Spacer for Speed Sensor Bracket

(2) 5/32" Black Air Line, 7 Foot long

Hardware Bag with ties, etc.

Dismantle Handlebar Plug, Proximity Plug and MALE 12 Pin Connector only on Interconnect Harness

LegUp Cover Plates (2)

Legs are strap down, normal wheel holders, wheel on high hole.