

# ORION

ORNAMENTAL IRON, INC.

*Iron Art*™  
by ORION

*Wood Art*™  
by ORION

## 2022 DECORATIVE DRAPERY HARDWARE CATALOG

*Hand Crafted with Pride Since 1983*



# *Iron Art*<sup>TM</sup> by **ORION**

☞ 3D Drapery Hardware (Finials in Front of Rod) .....	26
☞ 3D Drapery Panels (Finials and Stationary Panels in Front of Rod) .....	30
☞ Accessories .....	19
☞ Batons .....	23
☞ Brackets/Decorative Brackets .....	20
☞ Burgundy Collection (Hand Crafted Decorative Rods) .....	34
☞ Cornices, Crowns, and Decorative Scroll Work	
Mediterranean Collection (Lightweight Decorative Crowns) .....	36
Renaissance Collection (Lightweight Decorative Cornices) .....	37
Tuscany Collection (Decorative Metal Cornices, Available While Supplies Last) .....	38
Vienna Collection (Decorative Scrolls) .....	36
☞ Fina Collection (Thin Line Drapery Hardware) .....	25
☞ Finials	
Bohemia Collection (Decorative Hand Crafted Faceted Crystal-Glass Finials) .....	62
Eclectic Collection (Glass & Rattan Finials, <b>Discontinued</b> ) .....	18
Iron Finials .....	10
Italian Collection (Metal Plated Iron Drapery Hardware) .....	58
Provence Collection (Decorative Hand Blown Art Glass Finials, <b>Discontinued</b> ) .....	18
Village Forge Collection (Hand Crafted Iron Finials) .....	17
☞ Iron Art <sup>TM</sup> Finishes .....	80
☞ Italian Collection (Metal Plated Iron Drapery Hardware) .....	58
☞ Italian Collection Finishes .....	61
☞ Milano Collection (Roman Shades on Drapery Hardware, Available While Supplies Last) .....	25
☞ Oasis Collection (Expandable Sets) .....	24
☞ Rings .....	21
☞ Rods .....	19
☞ Swing Arms .....	21
☞ Tiebacks/Swag Holders .....	22
☞ Tropical Collection (Faux Bamboo on Iron, Available While Supplies Last) .....	32
☞ Unique Collection (Bypass System with “C” Rings) .....	24
☞ Xpress Yourway (Orion’s Quickship Program) .....	6

## **Manual and Motorized Traversing**

☞ Deco Lite Traversing (Lightweight Embossed Metal Panels, Available While Supplies Last) .....	50
☞ Designers’ Choice Traversing Rods (Iron Traversing Rods with Heavy Duty Hardware) .....	44
☞ Manual Traversing Accessories .....	49
☞ Motorized Traversing Accessories .....	56
☞ Traversing with Somfy Motorization .....	52
☞ Tuscany Traversing Collection (Lightweight Embossed Metal Rods and Heavy Duty Hardware, Available While Supplies Last) .....	46
☞ Measurement Guidelines .....	83
☞ Promotional Items/Designer Product Case .....	79
☞ Xpress Yourway (Orion’s Quickship Program) .....	6

# Wood Art<sup>TM</sup> by ORION

☞ Accessories .....	75
☞ Batons .....	75
☞ Brackets/Decorative Brackets .....	75
☞ Finials	
Bohemia Collection on Wood (Decorative Hand Crafted Faceted Crystal-Glass Finials) .....	68
New York Wood Collection (Exclusive Hand-Painted Wood Finials) .....	78
Rosina Collection (Decorative Resin Finials, Available While Supplies Last) .....	76
Wood Craft Collection (Hand Carved Finials, Swag Holders, Brackets, and Batons, Available While Supplies Last) ....	74
☞ Poles .....	75
☞ Rings .....	75
☞ Tiebacks/Swag Holders .....	75
☞ Wood Art <sup>TM</sup> Finishes .....	82

## Manual and Motorized Traversing

☞ Designers' Choice Traversing Poles (Wood Traversing Poles with Heavy Duty Hardware) .....	72
☞ Manual Traversing Accessories .....	49
☞ Motorized Traversing Accessories .....	56
☞ Traversing with Somfy Motorization .....	52
☞ Measurement Guidelines .....	83
☞ Promotional Items/Designer Product Case .....	79

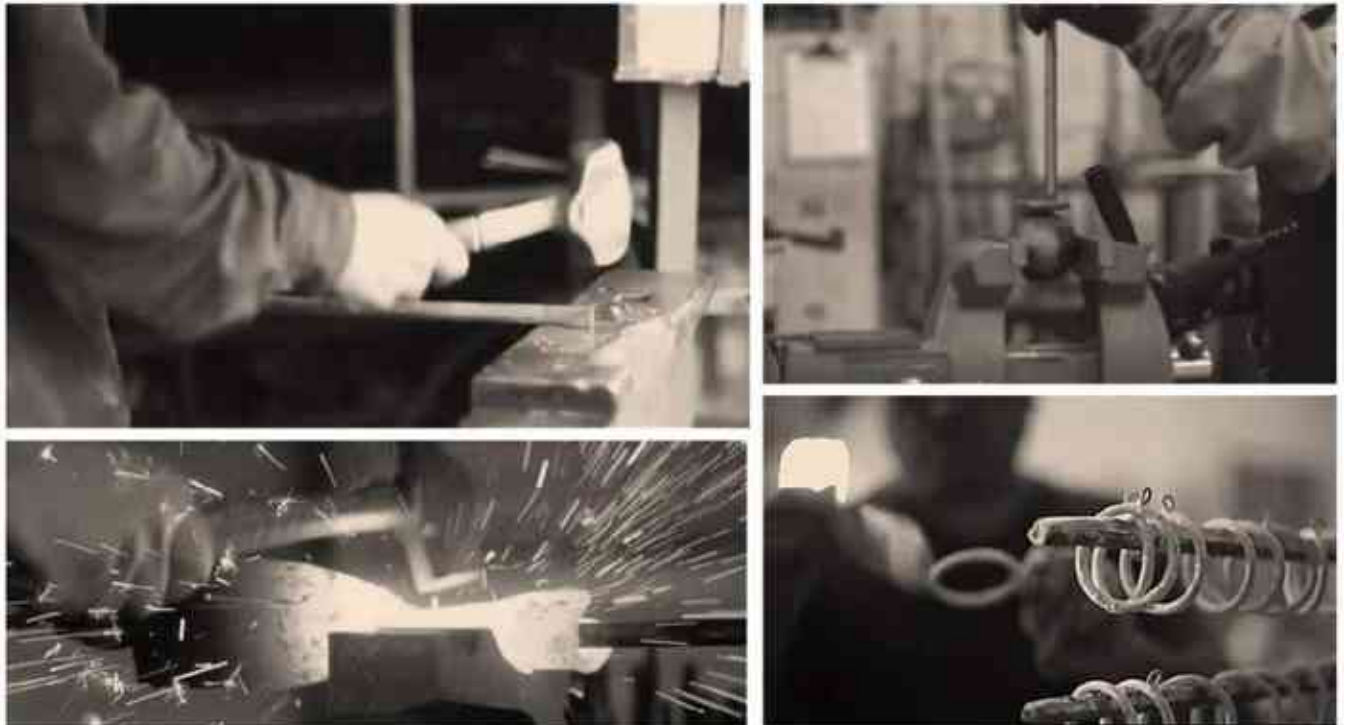

From design concept, to creation and assembly, to the final hand-painting, your order is hand-made just for you at Orion, here in the USA.

# *Iron Art*<sup>TM</sup> *by* **ORION**

From our humble beginnings as an iron workshop manufacturing gates and fences in 1983, Orion Ornamental Iron, Inc. has grown into an established and well-known national brand in the drapery hardware industry. Our diverse collections, many of them award-winning, cover a wide range of décor styles and drapery hardware functions to meet the needs of today's designers.

We are best known for our Iron Art<sup>TM</sup> collection. It includes a varied array of over 150 finials, traditional rods with rings or traversing systems with manual or motorized draw options, coordinating rings and brackets in a wide variety of choices, and plenty of accessories, all available in 35 beautiful Iron Art<sup>TM</sup> finishes. And since customization is our specialty, whether it's creating a finish, fabricating custom parts, or making a custom design, Orion can offer you a complete drapery hardware solution.



## What's New

- New Italian Collection 7 New Finishes
- New Somfy's Movelite 35™
- New Clear Vue Collection - Acrylic Drapery Hardware

**Please call to inquire more information  
about products**



Our most popular Iron Art™, Bohemia, and Italian finials with expedited shipping.

Two finish collections determine the shipping speed. Express It! finishes are shipped the next business day while Quicken It! finishes are shipped within 3 business days. Choose from eight finials in our Iron Art™ line, three finials in our Italian line, or nine Bohemia Crystal finials for either line. Complete your set with mounting hardware, rings, and accessories!

**Iron Art Line** - 1" and 1½" rod sizes, eight finials, and eight finishes. Coordinate with accessories, brackets, and rings.

**Express It! Finishes**  
Next Day Shipping

**Quicken It! Finishes**  
3 Day Shipping



Black (A)



Brown (A)



Light Brown (A)  
*(New!)*



New Nickel (B)  
*(New!)*



Antique Bronze



Antique Gold

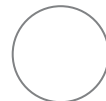

Pure White



Soft Pewter



**513**  
(1" x 2¼")



**420**  
(1¾" x 2")



**946**  
(2" x 2")



**505**  
(2¼" x 1½")



**947L**  
(2½" x 2½")



**906S**  
(3¼" x 3")



**966**  
(3½" x 2¼")



**950**  
(5¼" x 2½")

**Expandable Post Projection Tiebacks**

(3" to 4½" projection)



**1059 Rosette**  
(3" Diameter)



**1073**  
(3½" Diameter)



**1078**  
(3¾" x 3¾")

1" and 1½" rod sizes, eight finials, and eight finishes. Coordinate with accessories, brackets, and rings. - **Iron Art Line**



321  
Decorative Cap  
(For 1" & 1½" Rods)

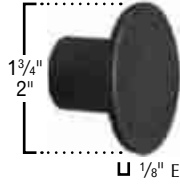

301  
End Cap *(New!)*  
(For 1" & 1½" Rods)

□ 1/8" Edge Thickness

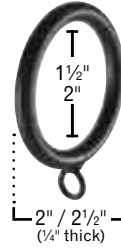

350  
Round Ring  
(For 1" & 1½" Rods)

### Mounting Brackets

### Sockets

#### 1028 Series

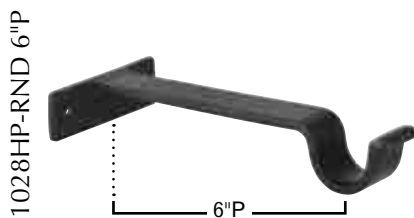
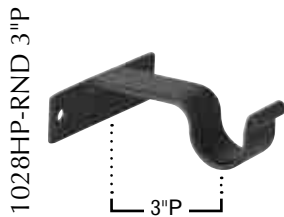
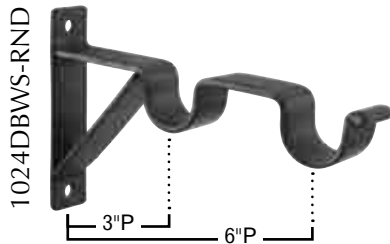
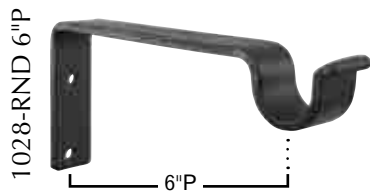
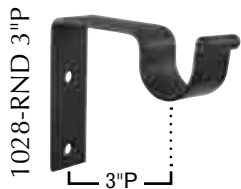

#### 1040 Series *(New!)*

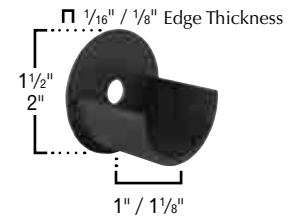
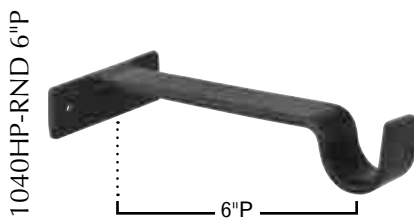
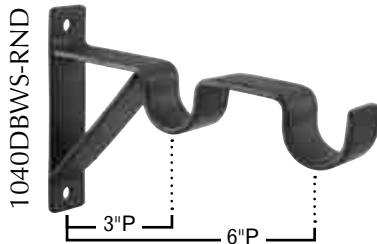
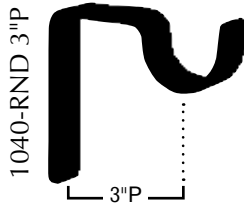

302 Socket *(New!)*  
(For 1" & 1½" Rods)

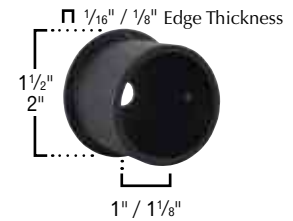

303 Socket *(New!)*  
(For 1" & 1½" Rods)

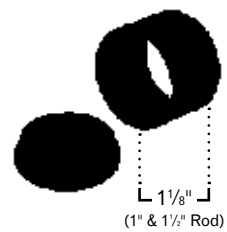

Socket  
306-100 (1" Rod)  
306-112 (1½" Rod)

1016 Baton  
with Clip  
Length: 48"  
Diameter: ½"

Our most popular Iron Art™, Bohemia, and Italian finials with expedited shipping.

Two finish collections determine the shipping speed. Express It! finishes are shipped the next business day while Quicken It! finishes are shipped within 3 business days. Choose from eight finials in our Iron Art™ line, three finials in our Italian line, or nine Bohemia Crystal finials for either line. Complete your set with mounting hardware, rings, and accessories!

**Bohemia Crystal Finials** - All Bohemia Crystals available in XpressYourway Program, Popular Styles Shown Below.



**787**  
 (3½" x 2")  
 Shown in Brown (19)



**775**  
 (2¾" x 2½")  
 Shown in Pure White (33)



**774**  
 (2" x 2¾")  
 Shown in Polished Chrome (IT 206)



**782 (New!)**  
 (2⅞" x 2¾")  
 Shown In Antique Bronze (02)



**790**  
 (¾" x 2")  
 Shown in New Nickel (12)



**788**  
 (3½" x 2")  
 Shown in Black (14)



**778**  
 (1¼" x 2⅜")  
 Shown in Brushed Nickel (IT 201)



**781 (New!)**  
 (2⅛" x 2⅜")  
 Shown In Antique Gold (06)



**772 (New!)**  
 (2¾" x 2⅜")  
 Shown In Soft Pewter (13)



**Ordering Information:**

1. All orders received by 12:00 noon Pacific time are considered same day orders. Shipping times are in business days.
2. Finials are interior fit only.
3. Modifications from specifications offered will not qualify for the Xpress Yourway program.
4. Cancellation of orders will result in a 35% restocking fee.
5. Please utilize the Xpress Yourway order form or mark orders as Xpress Yourway.  
Orders without an Xpress Yourway indication will be processed with standard shipping times.
6. Xpress Yourway Wall Display is available. Please see item #8002 on page 79.

**Italian Line - 1" round rod only**, three finials, and two finishes. Coordinate with accessories, brackets, and rings.

**Express It! Finishes**  
Next Day Shipping



**Mounting Brackets**

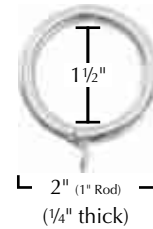
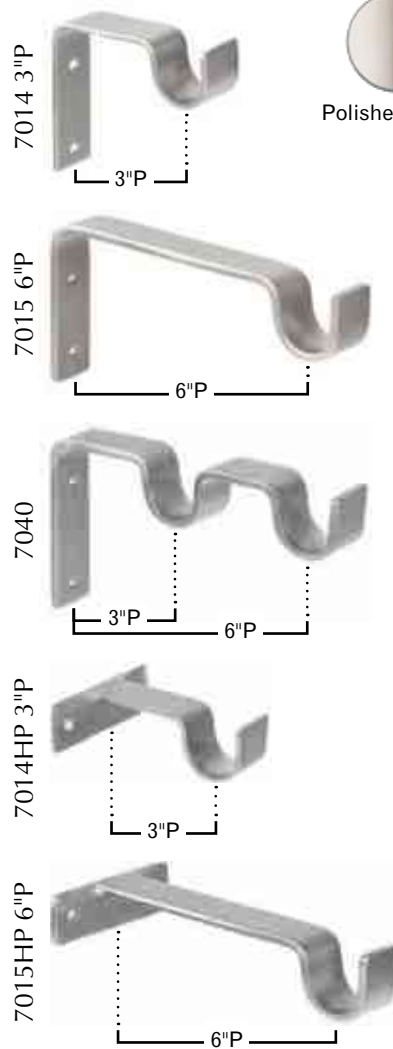

7013  
Ring with Eyelet

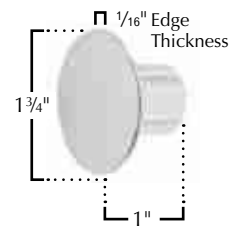

7016  
Metal End Cap

1014 Baton  
with Clip  
Length: 48"  
Diameter: 1/2"



7003  
(2" x 2")

7005  
(2" x 1 1/8")

7006  
(2" x 1")

# *New Finial Designs*

## *15 New Styles*



**Finial 550**  
6<sup>3</sup>/<sub>8</sub>" Long x 4" High x 3<sup>3</sup>/<sub>4</sub>" Deep  
Shown in Rich Gold (07) on a 1" round rod.



**Finial 551**  
3<sup>7</sup>/<sub>8</sub>" Long x 3<sup>7</sup>/<sub>8</sub>" High x 5<sup>5</sup>/<sub>8</sub>" Deep  
Shown in Burnt Gold (25) on a 1" round rod.



**Finial 552**  
4<sup>1</sup>/<sub>4</sub>" Long x 4<sup>1</sup>/<sub>4</sub>" High x 1" Deep  
Shown in Soft Pewter (13) on a 1<sup>1</sup>/<sub>4</sub>" fluted rod.



**Finial 553**  
4" Long x 4" High x 3<sup>3</sup>/<sub>4</sub>" Deep  
Shown in Antique Bronze (02) on a 1<sup>1</sup>/<sub>4</sub>" twist rod.



**Finial 554**  
3<sup>5</sup>/<sub>8</sub>" Long x 3<sup>5</sup>/<sub>8</sub>" High x 3<sup>5</sup>/<sub>8</sub>" Deep  
Shown in Soft Pewter (13) on a 1<sup>1</sup>/<sub>4</sub>" fluted rod.



# *New Finial Designs*

## *15 New Styles*



**Finial 555**  
 6<sup>7</sup>/<sub>8</sub>" Long x 6<sup>3</sup>/<sub>8</sub>" High x 1" Deep - 1<sup>1</sup>/<sub>2</sub>" at base  
 Shown in *Black (14)* on a 1<sup>1</sup>/<sub>2</sub>" square rod.



**Finial 9704**  
 2" Long x 1<sup>1</sup>/<sub>2</sub>" High x 1<sup>1</sup>/<sub>2</sub>" Deep  
 Shown in *Brown (19)* on a 3/4" square rod.



**Finial 556**  
 6<sup>3</sup>/<sub>8</sub>" Long x 2<sup>1</sup>/<sub>8</sub>" High x 1<sup>1</sup>/<sub>2</sub>" Deep - 1<sup>3</sup>/<sub>8</sub>" at base  
 Shown in *Naturelle (03)* on a 3/4" rope rod.



**Finial 9705**  
 2" Long x 1<sup>1</sup>/<sub>8</sub>" High x 1<sup>1</sup>/<sub>8</sub>" Deep  
 Shown in *Light Brown (09)* on a 3/4" round rod.



**Finial 557**  
 6" Long x 1<sup>5</sup>/<sub>8</sub>" High x 1<sup>1</sup>/<sub>4</sub>" Deep - 1<sup>1</sup>/<sub>4</sub>" at base  
 Shown in *Naturelle (03)* on a 3/4" rope rod.



**Finial 9705L**  
 3" Long x 1<sup>3</sup>/<sub>4</sub>" High x 1<sup>3</sup>/<sub>4</sub>" Deep  
 Shown in *Antique Gold (06)* on a 1<sup>1</sup>/<sub>4</sub>" round rod.



**Finial 558**  
 2" Long x 2<sup>5</sup>/<sub>8</sub>" High x 2<sup>5</sup>/<sub>8</sub>" Deep - 1<sup>3</sup>/<sub>4</sub>" at base  
 Shown in *New Nickel (12)* on a 1" square rod.



**Finial 9706**  
 2" Long x 1" High x 1" Deep  
 Shown in *Black (14)* on a 3/4" square rod.



**Finial 559**  
 1<sup>1</sup>/<sub>8</sub>" Long x 2<sup>1</sup>/<sub>4</sub>" High x 2<sup>1</sup>/<sub>4</sub>" Deep  
 Shown in *Bronze Vecchio (15)*  
 on a 1" hammered twist rod.



**Finial 9706L**  
 3" Long x 1<sup>3</sup>/<sub>4</sub>" High x 1<sup>3</sup>/<sub>4</sub>" Deep  
 Shown in *Antique Copper (10)*  
 on a 1<sup>1</sup>/<sub>2</sub>" square rod.

# Finials

All finials are available as interior or exterior fit. If not specified, interior fit is provided. Finials shown in *Naturelle* finish.

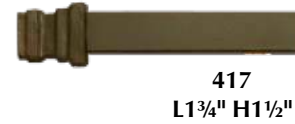
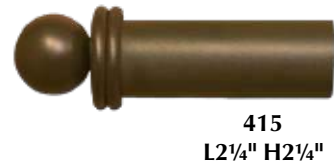

403  
L8" H6½"  
**HAND FORGED**  
*Shown as Ceiling Mount. Also available as Finial.*



# Finials

Finials shown in Naturelle finish.



421  
L6½" H3¼"



Only available as shown.  
422  
L3½" H5¾"



501  
L6" H6"



502  
L4" H4"



503  
L8" H4"



505  
L2¾" H1½"

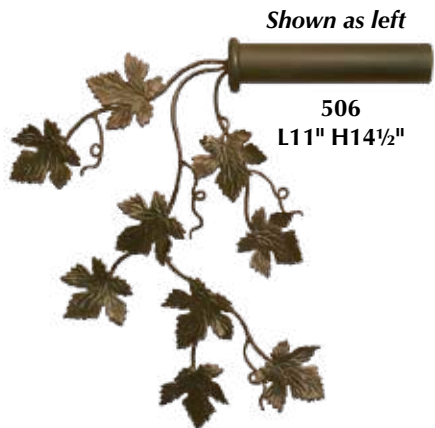

Shown as left  
506  
L11" H14½"



Shown as left  
507  
L9¼" H8¼"



508  
L6¾" H8"



509  
L9½" H8"



510  
L5½" H9¾"



511  
L1" H2"



512  
L1¾" H2¼"



513  
L1" H2¼"



HAND FORGED  
Shown as left  
707  
L6½" H5¾"



Shown as left  
711  
L9¼" H9½"



HAND FORGED  
Shown as left  
900S (Small)  
L6¼" H7"  
900M (Medium)  
L9" H7"



901  
L7½" H3¾"



902  
L7¾" H4¼"



903  
L5½" H4"



904S (Small)  
L6" H2¾"



904L (Large)  
L9" H4¼"

...to enhance your home!

# Finials

Finials shown in Naturelle finish.



905  
L5" H2¼"



912  
L6¼" H1½"



Shown  
as left

929  
L5" H3"



906S (Small)  
L3½" H3"



913S (Small)  
L3¾" H3"



Movable  
Finial

Shown  
as left

929MV  
L5" H3"



906L (Large)  
L5" H4¾"



913L (Large)  
L4" H3¾"



Only  
available  
as shown

933  
L4½" H2½"

HAND FORGED



907  
L5¼" H3¾"

HAND FORGED



908  
L5¼" H4"



914  
L4" H3"



934  
L7¾" H2¾"



909  
L8" H2½"



916  
L2" H1½"



935  
L9" H5"

HAND FORGED



910  
L5½" H5"



921  
L5¼" H3½"

HAND FORGED  
Shown as left



936  
L6¾" H3¾"



911  
L5½" H2¾"



Shown as left

927  
L4¼" H4¾"

HAND FORGED  
Shown as left



937  
L10½" H5½"

# Finials

Finials shown in Naturelle finish.

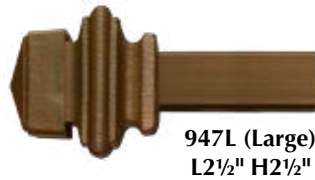
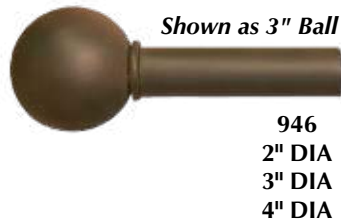

..just let your imagination take over!

# Finials

Finials shown in Naturelle finish.

Shown as left

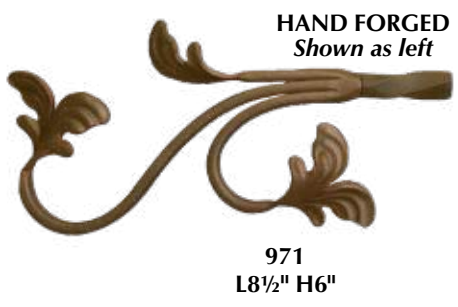
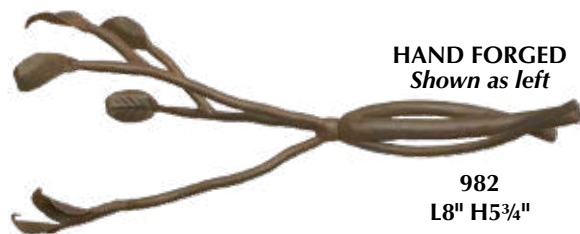

Let our finials turn each window into a Work of Art!



# Village Forge Collection

## Hand Crafted Iron Finials

All finials shown as left.



Finial: 600  
Finish: Autumn  
L7 1/2" H9"



Finial: 604  
Finish: Burnt Silver  
L7 1/2" H2 3/4"



Finial: 601  
Finish: Rich Gold  
L8 1/2" H6"



Finial: 605  
Finish: Antique White  
L6 1/2" H6"



Finial: 602S (Small)  
Finish: Autumn  
L5 3/4" H3 1/8"



Finial: 606  
Finish: Bronze Vecchio  
L8 1/4" H7 1/4"



Finial: 602L (Large)  
Finish: Burnt Silver  
L7" H4 1/4"



Finial: 607  
Finish: Cherry Gold  
L9" H4 3/4"



Finial: 603  
Finish: Antique Copper  
L8 1/2" H8"



Finial: 608  
Finish: Cherry Gold  
L6" H6"

*Journey into Wrought Iron Craftsmanship.*

# Provence Collection

## Decorative Hand Blown Art Glass Finials

DISCONTINUED.



**Finial: 830**  
L4½" H3"  
**Rod Finish:**  
Brushed Nickel



**Finial: 833**  
L4½" H3"  
**Rod Finish:**  
Antique Gold



**Finial: 836**  
L3¼" H3¼"  
**Rod Finish:**  
Antique Copper



**Finial: 831**  
L4½" H3"  
**Rod Finish:**  
Rich Gold



**Finial: 834**  
L4½" H3"  
**Rod Finish:**  
Brushed Nickel



**Finial: 837**  
L3¼" H3¼"  
**Rod Finish:**  
Antique Bronze



**Finial: 832**  
L4½" H3"  
**Rod Finish:**  
Antique Copper



**Finial: 835**  
L3¼" H3¼"  
**Rod Finish:**  
Black



**Finial: 838**  
L3¼" H3¼"  
**Rod Finish:**  
Polished Chrome

# Eclectic Collection

DISCONTINUED.



**801**  
L4½" H2¾"



**802**  
L5½" H3½"



**803**  
L4½" H3"



**804**  
L4½" H3"



**805**  
2¾" DIA



**806**  
L3" H2½"



**807**  
L4¾" H2¾"



**808**  
L4¾" H2¾"



*Available  
in Italian  
Connectors  
only*

**809**  
L6¼" H3¼"

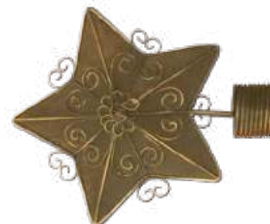

*Available  
in finish as  
shown only*

**810**  
L5¼" H5¼"



*Available  
in finish as  
shown only*

**811**  
L5¼" H5¼"

# Iron Art Accessories



313 KNOB  
H1" 1/4" Thick



314 HOOK  
P1 1/2"  
Available in  
specified size only.



214 HOOK  
L3" H1 3/4" P1 1/2"  
Available in  
specified size only.

Available in  
specified size only.



311  
HOOK BRACKET  
P3"



310  
HOOK PEG  
L2 3/4" H3 1/2"



316S (Small)  
3" to 5" ID  
3/8" Thick



316L (Large)  
6" to 12" ID  
1/2" Thick

Specify Inner  
Diameter when  
ordering.

## RING BRACKETS



302



303



308  
DECORATIVE  
SOCKET  
L5" H2"

## SOCKETS



301 CAP  
Interior Fitting



321  
DECORATIVE  
END CAP  
Interior Fitting

## END CAPS



307  
MITER  
PER CUT

309 Elbow with  
interior fit required.

Angle can be modified.  
Additional charges apply.

## ELBOWS



309 ELBOW  
Shown as 90° exterior fit.  
Specify interior or  
exterior fit, 45° or 90°.



315  
MOVABLE ELBOW  
Interior Fitting



312  
CORNER BRACKET  
3" TO 4 1/2" P  
Exterior fit only.  
Specify 45° or 90°.



320  
MOVABLE  
CORNER BRACKET  
3" TO 4 1/2" P  
Interior Fitting



300 CONNECTOR

# Rods

Rings are not included. Please order separately. Additional charges for threading the rods apply.

## ROUND HOLLOW ROD



## ROUND HOLLOW HAMMERED ROD



## ROUND SOLID ROD



## ROUND SOLID HAMMERED ROD



## TWIST HOLLOW ROD



## TWIST HOLLOW HAMMERED ROD



## SQUARE HOLLOW ROD



## SQUARE HOLLOW HAMMERED ROD



## ROPE ROD



## WOOD GRAIN SOLID ROD



## FLUTED ROD Only available as 1 1/4" OD



## ROD WITH RETURN #264

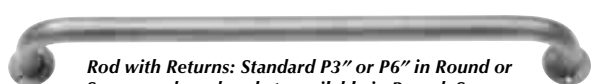

Rod with Returns: Standard P3" or P6" in Round or Square rods and sockets available in Round, Square or Vertical Back Plates. Please refer to page 32 and 33 of IA Price List for line drawings

# Brackets

We recommend brackets at a distance of every 48" for normal use.  
Please see the Bracket Guide on page 18 of the Price List for sizes.



1010-RND  
P3"



1028-RND  
P6"

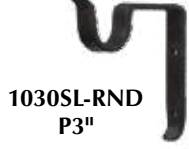

1030SL-RND  
P3"



1040HD-RND  
P3"



1011-RND  
P3" H3"



1028HP-RND  
P3"

Top Weld  
Standard.  
Center Weld  
Available on  
Request.  
Also Available  
in HD  
(Heavy Duty).



1033-RND  
P3"



1040DBWS-RND  
P3" & P6"



1021S-RND  
P1½"



1028EXP-RND  
P3" - 4¼"



1034-RND  
P3"



1040EBP-RND  
P3"



1021-RND  
P3"



1028HD-RND  
P3"

Ceiling Mount  
Bracket

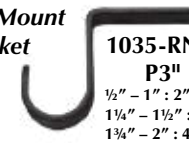

1035-RND  
P3"

½" - 1" : 2" drop x 2" Proj.  
1¼" - 1½" : 3" drop x 2" Proj.  
1¾" - 2" : 4" drop x 2" Proj.



1040HP-RND  
P3"

Top Weld  
Standard.  
Center Weld  
Available on  
Request.  
Also Available  
in HD  
(Heavy Duty).



1024DBWS-RND  
P3" & P6"



1028WS-RND  
P3"

Double Ceiling Mount Bracket



1036-RND  
P3" & P6"



1040WS-RND  
P3"

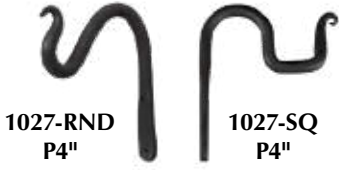

1027-RND  
P4"

1027-SQ  
P4"



1028EBP-RND  
P3"



1038-RND  
P4"



1040EXP-RND  
P3" - 4¼"



1028-RND  
P3"



1029-RND  
P4"



1040-RND  
P3"

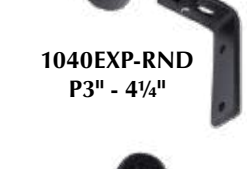

1046-RND  
FOR ½"-1" RODS  
P1½"



1028-SQ  
P3"



1030-RND  
P3"



1040-SQ  
P3"

# Decorative Brackets



1100  
L3½" H3¾"  
Shown as Right



1102  
L2¼" H4"



1103  
L3" H2¾"



1104  
L2½" H8"



1105  
L4½" H2½"



1106  
L5" H3"  
Shown as Left

# Rings

Eyelets can be modified as per drawing, additional charges apply. Please see the Ring Guide on page 20 of the Price List for sizes. We recommend the inner diameter of the ring to be 1/2" LARGER than rod diameter. Rings are 1/4" thick. Bypass system "C" Rings available on page 24.



350 ROUND RING      351 TWISTED RING      352 SQUARE RING      353 FORGED RING      354 HOOK RING      355 ROUND RING WITH CLIP      356 ROUND HAMMERED RING

# Swing Arms

Measurements are based from the end of the back plate to the outer tip of the finial.

1074 1/2" ROUND & 1074A 3/4" ROUND, 1/2" PROJECTION  
Mounting Plate Style R1: L1" H4"  
H = 5" (height above the rod)

1075 3/4" ROUND, 1/2" PROJECTION  
Mounting Plate Style R1: L1" H4"  
Minimum Length: 18"

1090 5/8" TWIST HOLLOW, 1/2" PROJECTION  
Mounting Plate Style D3: L3" H3"

1091 3/4" ROUND, 1/2" PROJECTION  
Mounting Plate Style R2: L2" H4"  
Minimum Length: 36", Shown as Right  
H = 6 1/2" (height above the rod)

1092 3/4" ROUND, 1/2" PROJECTION  
Mounting Plate Style R2: L2" H4"  
Minimum Length: 18"  
H = 6 1/2" (height above the rod)

1093 1" ROUND, 1/2" PROJECTION  
Mounting Plate Style R2: L2" H4", Shown as Right  
Movable Finial (#929MV) at Additional Charge

HAND FORGED

1094 1/2" SQUARE SOLID, 1/2" PROJECTION  
Shown with welded eyelets (#317) equally spaced.  
Mounting Plate Style R1: L1" H4"

1097 P3" H5"  
Mounting Plate P3"

1098 P6" H5"  
Mounting Plate P6"

1099 SUPPORT BRACKET  
1/2", P3" & P6"

*Distinctive styling, solid craftsmanship!*

# Tiebacks/Swag Holders

Tiebacks/Swag Holders are available as Expandable Post Projection, Fixed Post Projection, or "U" Shape Bend. Additional charges will apply for any modification. When ordering, please specify the tieback style. If not specified, the style shown in the catalog will be sent.

"U" Shape Bend  
shown as right



715  
L8½" H4"



1005  
2¾" DIA



1032  
L4½" H6¼"



1060  
ROSETTE  
3¾" DIA

"U" Shape Bend  
shown as right



716  
L8½" H5¾"



1006  
L9" H4¼"

Only available as  
"U" Shape Bend



Shown  
as right

1037  
L8" H6"



1061  
ROSETTE  
4½" DIA



Post Tieback  
shown as left

929TB  
L5" H3"



1007  
L12½" H4¾"

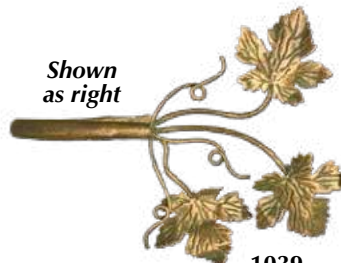

Shown  
as right

1039  
L9¾" H8"



1063  
POPPY  
2¾" DIA

Only  
available  
as shown



933TB  
L4½" H2½"



1008  
L13¼" H5¼"



1064  
FLEUR DE LIS  
L4¾" H5¾"



977  
HORSESHOE  
L4¾" H5¼"



1013  
L8" H1"



1057  
L10" H7¾"



1065  
MOON  
L4" H4½"  
Only  
available  
as shown



1003  
L4¾" H4¾"



1026  
L3" H6"



1058\*  
ROSETTE  
3" DIA



1066  
STAR  
L5¼" H5¼"

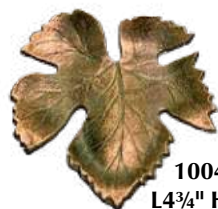

1004  
L4¾" H5"



1031\*  
3½" DIA



1059\*  
ROSETTE  
3" DIA



1067  
LION  
L4½" H5½"

# Tiebacks/Swag Holders

Tiebacks/Swag Holders are available as Expandable Post Projection, Fixed Post Projection, or "U" Shape Bend.  
Additional charges will apply for any modification. When ordering, please specify the tieback style.  
If not specified, the style shown in the catalog will be sent.



1068  
OAK  
L7½" H3¾"  
Post Tieback  
shown as left



1073  
3½" DIA



1080  
4¼" DIA

## Flush Mount Swags



1085  
L3" H6¼"



Front View



Side View

1086  
3" DIA



1069  
ROMAN  
L12" H6½"

Post Tieback shown as left



1076  
L3" H4¾"



1081  
L7" H6½"  
Only  
available  
as shown



Post Tieback  
shown as left

1070  
ROSE  
L8" H4¼"



1077  
L3" H6¼"



1082  
L2½" H6¾"



1071  
SWIVEL TIEBACK  
L6¾" H11"  
HAND FORGED



1078  
3¾" DIA



1083  
L4" H4¼"



1088 POST PROJECTION  
BACK PLATE  
Expandable from 3" to 4½"  
Mounting Plate is 2"



1088FX POST PROJECTION  
BACK PLATE  
Fixed Projections in  
3", 4" or 6½"  
Includes Mounting Plate

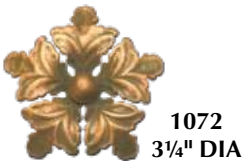

1072  
3¼" DIA



1079  
6¼" DIA



1084  
L3½" H9"

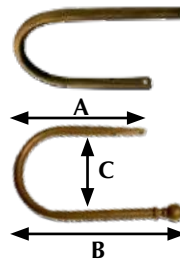

1087  
"U" SHAPE BEND  
Projection 3½"

2087 "U" SHAPE BEND  
WITH BALL FINIAL  
Projection 3½"  
(A=4 ½", B=8 ½" including  
finial, C=3 ½")

## Batons

Specify Ring or Clip

Available with or  
without eyelet.

1015

Available with or  
without eyelet.

1016

1017

1018

1019

1020



- 1015: IRON ROUND ROD ½" DIA
- 1016: IRON ROUND ROD ½" DIA
- 1017: IRON TWIST ROD ¼" DIA
- 1018: IRON ROUND ROD ½" DIA
- 1019: IRON SQUARE ROD ½" DIA
- 1020: IRON ROUND ROD ½" DIA  
W/ WOODEN HANDLE

...for a complete, coordinated look!

# Unique Collection

## Bypass System with "C" Rings

Available in 3/4" diameter and above. Straight Round Hollow Rods only.  
Available in all Iron Art™ and Italian Collection finishes. Shown in Soft Pewter.



### RINGS



330C  
"C" RING

Single Rod System

Double Rod System



Side View

1045

Top View

### BRACKETS



1028SE  
3" P SINGLE  
END BRACKET



1028SE  
6" P SINGLE  
END BRACKET



1024DE  
3" & 6" P  
DOUBLE END  
BRACKET



318SC  
3" P SINGLE  
SUPPORT  
BRACKET



318SC  
6" P SINGLE  
SUPPORT  
BRACKET



319DC  
3" & 6" P  
DOUBLE  
SUPPORT  
BRACKET

Horizontal Plate Bottom Weld  
is available (318SC-HP-3"P)

Horizontal Plate Bottom Weld  
is available (318SC-HP-6"P)

## Oasis Collection

### Expandable Sets

Rod diameter is a combination of 1" & 7/8"



913 ES  
L3 3/4" H3"



946 ES  
2" DIA



916 ES  
L2" H1 1/2"



956 ES  
L6 1/4" H4 1/4"

Sets are available as:		
Small	27"-48"	2 Brackets
Medium	45"-82"	3 Brackets
Large	81"-118"	3 Brackets
Extra Large	117"-154"	4 Brackets
All sets include Rods, Finials, and Brackets.		



966 ES  
L3 1/2" H2 1/4"



976 ES  
L2 1/4" H2 1/4"



# Milano Collection

## Roman Shades on Drapery Hardware

Shown as assembled set. Available as round 5/8" diameter rod only. Available While Supplies Last.

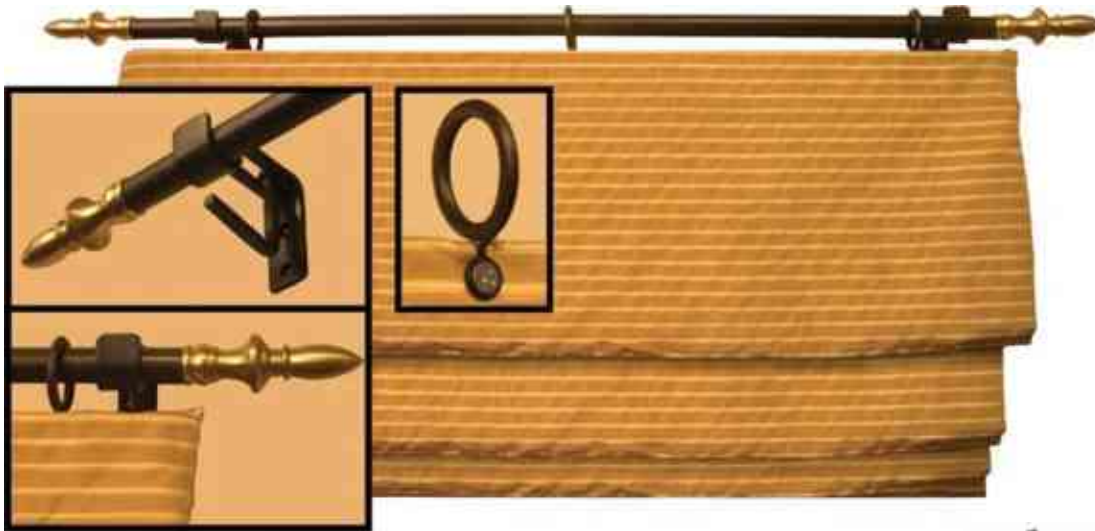











								
2070 (Discontinued)	2071	2072	2073	2074	2075	2088 EXTENDED EYELET	2080 P2"	2082 P2"
L1 1/4" H1"	L1 1/2" H1"	L1 1/2" H1 1/2"	L3" H1"	L2 1/2" H1 1/4"			2081 P3"	2083 P3"
<i>Interior fit only. These finials are also available in a brass finish. Variations in tones may occur.</i>								2084 P3" & P6"

# Fina Collection

## Thin Line Drapery Hardware

Available for 1/2" rod diameter only. Finials as exterior fit only. Rod and rings not included.

			
2060 L3 1/2" H1 3/4"	2010 L1 1/4" H1 1/2"	2020 L4" H2 1/2"	2030 L4 1/2" H3"
			
2050 L4 1/8" H1 3/4"	2040 L4 1/4" H1"	2025 L5 1/4" H2 3/4"	2015 3/4" DIA
			
1041P1 P1" H2" W 1/2"	1041P2 P2" H2" W 1/2"	2087 P3 1/2"	

# *3D Drapery Hardware*

## *Finials in Front of Rod*

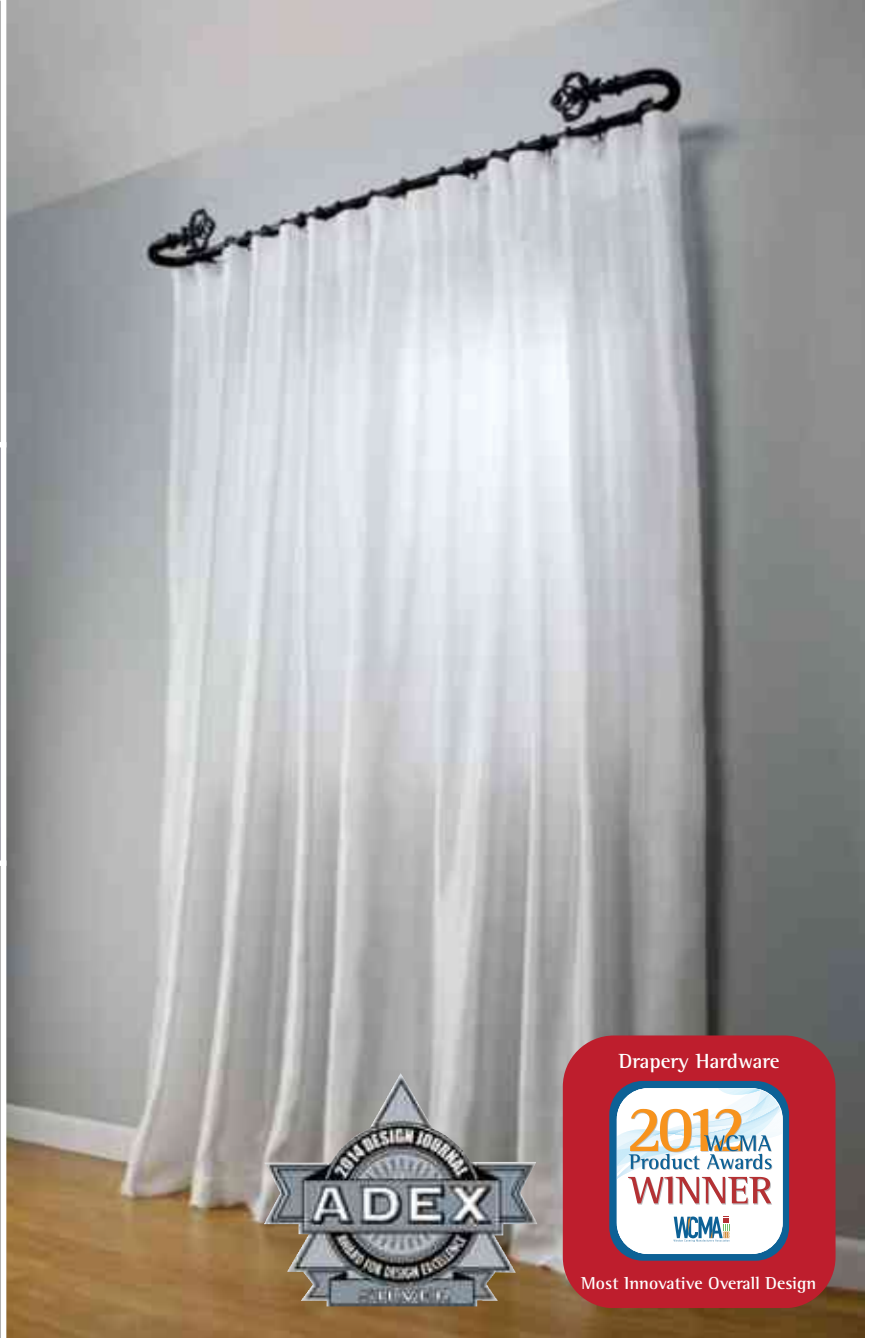
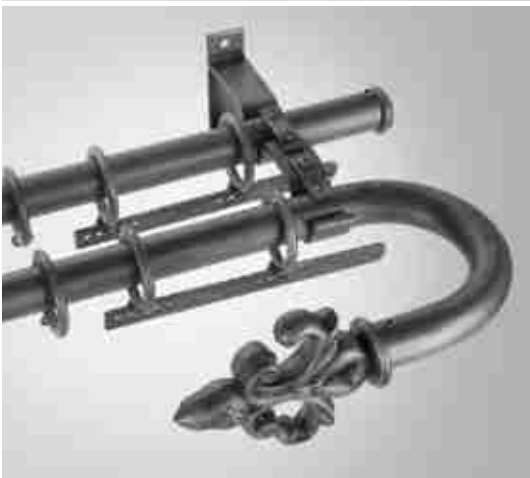

Explore new window designs with the ability to have the finial in front of the rod. Finials can also be manually adjusted to be above or below the rod simply by changing their position to enhance the window covering presentation.

Combined with our master carriers, which help reduce light gaps, this system is also great for tight areas where you may not be able to fit the finial you would like to use when using conventional drapery hardware.

Nearly all our finials are available for use with the 3D system (some exceptions are listed on page 27). Rods are 1" diameter in either round hollow smooth (Iron and Italian) or hammered styles (Iron only). Choose from 35 Iron Art™ finishes, 5 Italian finishes, or your own custom finish.

# 3D Drapery Hardware

## Finials in Front of Rod

3D Drapery Hardware can be used with single or double rod systems. Back rods in the double rod system are the same length as the front rod, including their end caps. Straight master carriers allow the drapery to pass the end brackets, giving you maximum window coverage. Begin your order by selecting your 3D Drapery Hardware Kit from the selections below.

### 3D Drapery Hardware Kits:

#### 3D Single Kit:

- Two 180° U-Bends for one iron rod.
- Two straight master carriers for rings.
- Four rings (two for each straight carrier).

#### 3D Double Kit:

- Two 180° U-Bends for one iron rod.
- Four straight master carriers for rings.
- Eight rings (two for each straight carrier).
- Two end caps for one back rod.

Description	Item #
3D Single Kit for Iron Art Finishes	3D-SIA
3D Single Kit for Italian Finishes	3D-SIT

Description	Item #
3D Double Kit for Iron Art Finishes	3D-DIA
3D Double Kit for Italian Finishes	3D-DIT

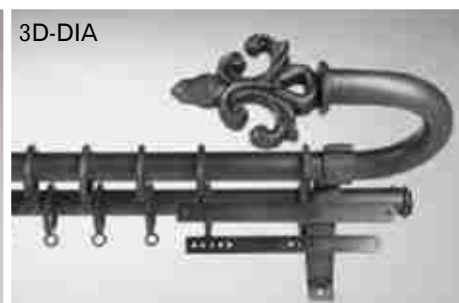
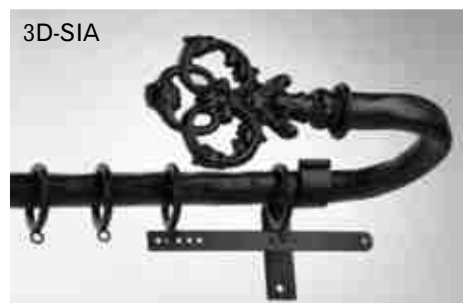

Kit images shown with additional rings.

### Drapery Hardware:

#### 1" Round Hollow Rods

- Available in 35 Iron Art™ finishes, 5 Italian finishes, or your own custom finish.
- May be used with Bypass Rings.

#### 1" Round Hollow Hammered Rods

- Available in 35 Iron Art™ finishes, or your own custom finish.
- **Not for use with Bypass Rings.**

#### Finials

- Choose from almost any Iron Art™ finial, all Italian finials, and all Bohemia Crystal finials. (See exceptions listed under Finials.)

#### Brackets

- Brackets ordered for use with the 3D system include lids and set screws to keep rods secure.

#### Rings

- Choose from any style of ring.

#### Overlap Master Carrier Set (optional):

- Works with center open draperies and rings for complete drapery closure in the front.

### Finishes:

Iron Art™ drapery hardware is available in 35 Iron Art™ finishes, or your own custom finish. Italian drapery hardware is available in five Italian finishes: Brushed Nickel, Black Nickel, Oiled Bronze, Satin Copper, and Satin Gold. *Polished Chrome is not available for 3D Drapery Hardware.*

### Rods:

Choose from 1" diameter round hollow rods in smooth or hammered styles. Order by your rod length tip to tip. (See measurement guidelines on page 29.)

Iron Art Rods	Italian Rods
Description	Description
1" Diameter Round Hollow Rod	1" Diameter Round Hollow Rod
1" Diameter Round Hollow Hammered Rod	

### Finials:

Because of their size and branch shape, we don't recommend the 3D system for use with Iron Art™ finials 410, 416, 506, 711, 939, 954, 979, and 982, and Village Forge finials 600, 601, 603, and 606. All other Iron Art™ finials, Italian finials, and Bohemia Crystal finials may be utilized.

# 3D Drapery Hardware

Position the U-Bends from horizontal to vertical, and anything in between, with the use of our brackets with lids and set screws.



## Brackets:

Choose from any of our Iron Art™ brackets. We will add lids and set screws to keep your rods secure, allowing you to position the 3D rod at various angles.

## Rings:

Choose from any of our Iron Art™ rings. 3D Kits and Overlap Master Carrier Sets will come with two matching rings for each carrier.

## Bypass System:

3D Drapery Hardware using smooth rods can be utilized with our Unique Collection support brackets and "C" Rings for one way draw.

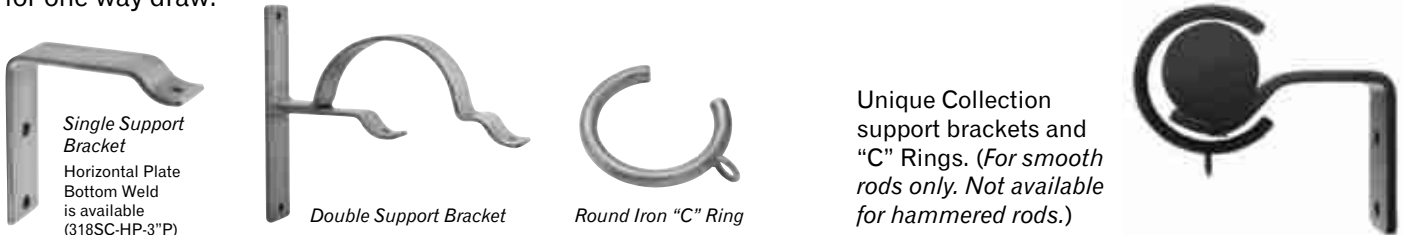

*Single Support Bracket*  
Horizontal Plate  
Bottom Weld  
is available  
(318SC-HP-3"P)

*Double Support Bracket*

*Round Iron "C" Ring*

Unique Collection  
support brackets and  
"C" Rings. (For smooth  
rods only. Not available  
for hammered rods.)



*Single rod system shown with one way draw in Italian finish Brushed Nickel.*



*Double rod system shown with one way draw in Iron Art™ finish Soft Pewter.*

# 3D Drapery Hardware

## Finials in Front of Rod

### Overlap Master Carrier Set (optional):

This set works with center open draperies and rings for complete drapery closure.

Description	Item #
Overlap Master Carrier Set in Iron Art Finishes	MCS-IA
Overlap Master Carrier Set in Italian Finishes	MCS-IT

### What's Included:

- One straight master carrier for rings.
- One overlap master carrier for rings.
- Four rings (two for each carrier).



Overlap Master Carrier Set with Rings.



Overlap Top View.



Single hammered rod system shown as center open in Iron Art™ finish black.

### Measurement Guidelines:

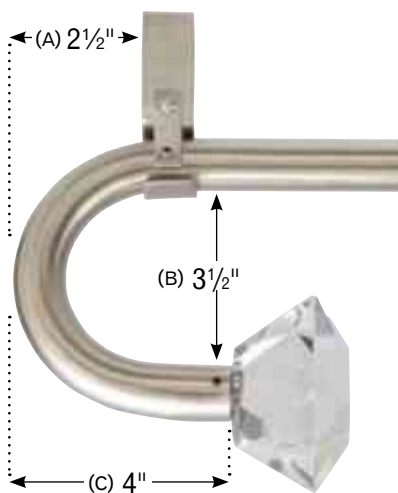

- A) The distance from the end of the straight rod to the edge of the curve is 2½".
- B) The U-Bend projection is 3½".
- C) The front face of the U-Bend is 4" long, not including the finial.
- D) **Order your rod length tip to tip.**
- E) Available in 1" diameter round hollow smooth or hammered styles, single or double rod systems. Back rods in the double rod system are the same length as the front rod, including their end caps.



# *3D Drapery Panels*

## *Finials and Stationary Panels in Front of Rod*

---



Introducing our latest product addition, 3D Drapery Panels. Similar to our 3D Drapery Hardware, 3D Drapery Panels allow you to have the finial in front of the rod, perfect for tight spaces. But now the wrap around front portion of the rod can be used for stationary panels. Just give us the length up to 24" on each side.

Specially designed brackets provide support for the front panel rods. Bypass rings for the functional drapery behind the panels allow the curtain to pass under the support brackets.

Available for 1" smooth round hollow rods in 35 Iron Art™ finishes, 5 Italian finishes, or your own custom finish.



3D319DC Bracket

# 3D Drapery Panels

## 3D Drapery Panel Kits Include:

- Two 180° U-Bends for One Iron Rod
- Two Front Panel Rod Extensions Up To 24" Long
- Two 3D319DC Support Brackets
- Two Straight Master Carriers for Rings
- Four Bypass "C" Rings (Two for Each Straight Carrier)

Description	Item #
3D Panel Kit for Iron Art Finishes	3D-PIA
3D Panel Kit for Italian Finishes	3D-PIT

## Order Along With:

### 1" Smooth Round Hollow Rods

- Available in 35 Iron Art™ finishes, your own custom finish, or five Italian finishes: Brushed Nickel, Black Nickel, Oiled Bronze, Satin Copper, and Satin Gold. *Polished Chrome is not available for 3D Drapery Hardware.*

### Finials

- Choose from almost any Iron Art™ finial, all Italian finials, and all Bohemia Crystal finials. Because of their size and branch shape, we don't recommend the 3D system for use with Iron Art™ finials 410, 416, 506, 711, 939, 954, 979, and 982, and Village Forge finials 600, 601, 603, and 606.

### Rings

- Choose from any style of ring for the front panels.
- Use Unique Collection Bypass "C" Rings for functional rear draperies (330C or 7330C).

### Additional Brackets

- Use Unique Collection Single Bypass End Brackets (1028SE or 7014SE).
- Use Unique Collection Single Bypass Support Brackets for additional support (318SC or 7318SC).



Bypass "C" Ring

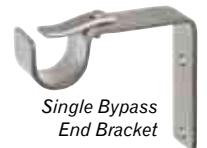

Single Bypass End Bracket



Single Bypass Support Bracket  
Horizontal Plate Bottom Weld is available (318SC-HP-3"P)

## Optional Hardware:

### Overlap Master Carrier Set

- Works with center open draperies and rings for complete drapery closure in the front (MCS-IA or MCS-IT).

### Batons

- Easily open and close draperies while minimizing handling to keep them clean (1015-1020 or 1014).



Overlap Master Carrier Set with Rings.

## Measurement Guidelines:

- Order your rod length tip to tip.
- Order your front panel rod extension length up to 24".
- The U-Bend projection is 3½".
- Two Straight Master Carriers and four Bypass "C" Rings are included in the set.
- Two 3D319DC Support Brackets are included in the set.

## Order These in Addition to the Kit:

- 1" diameter Smooth Round Hollow Rod
- Finials
- Rings for front panel
- Unique Collection Bypass "C" Rings for rear draperies (330C or 7330C)
- Unique Collection Bypass End Brackets (1028SE or 7014SE)
- Optional Overlap Master Carrier Set

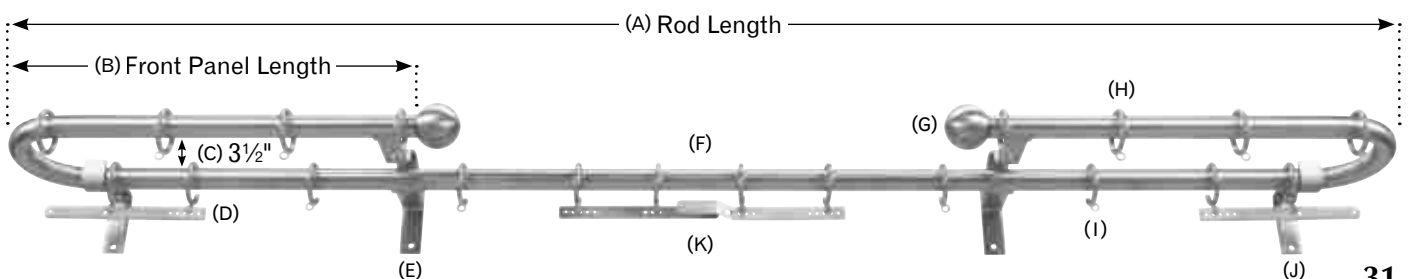

# Tropical Collection

## Faux Bamboo on Iron

### Finials

Available While Supplies Last.



Side View

9000  
PALM LEAF  
L5¼" H9"

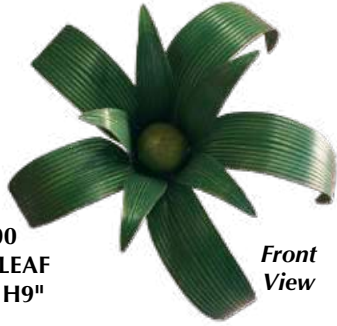

Front View



Side View

9003  
SHELL  
L5¾" H4"



Top View



Side View

9001  
BAMBOO  
LEAVES  
L6½" H7"

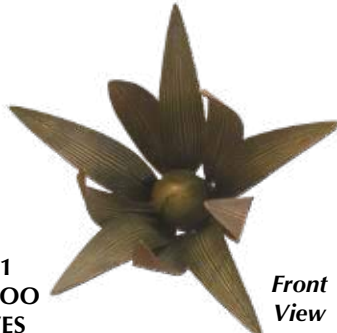

Front View



Side View

9004  
BAMBOO CAP  
L¾" H2"



Front View



Side View

9002  
COCONUT  
L7¼" H5"

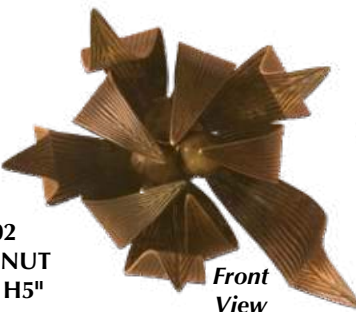

Front View

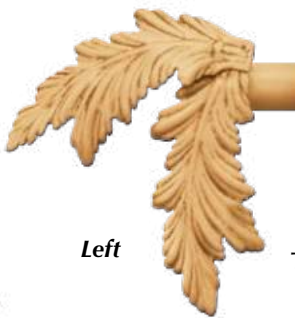

Left

9005  
TROPICAL  
ACCENT  
L5¾" H6"

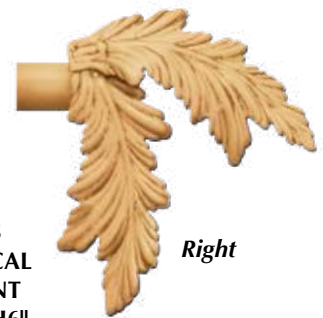

Right

### Decorative Cornices

Optional Wood Duster available. Refer to Product #8046 and #8047 (Tuscany Collection) in Price List

Front View



Detail View



9040  
(Shown as H3½")  
Also Available as 9040D (H5½")

MOTORIZATION &  
CORD DRAWN TRACKS  
AVAILABLE!  
Call for Quote



# Tropical Collection

## Faux Bamboo on Iron

### Rods

Available While Supplies Last.



9020 3/4", 1", 1 1/4", 1 1/2", AND 2" DIAMETER STRAIGHT RODS



9020BT 3/4", 1", 1 1/4", 1 1/2", AND 2" DIAMETER BENT RODS



9022 3/4", 1", 1 1/4", 1 1/2", AND 2" DIAMETER DECORATIVE RODS

### Swing Arms

Measurements are based from the end of the back plate to the outer tip of the finial.

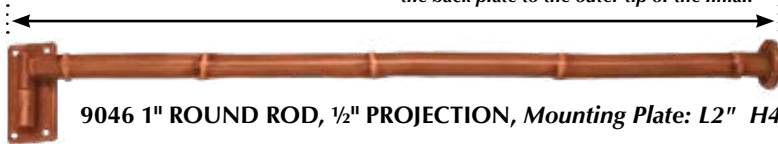

9046 1" ROUND ROD, 1/2" PROJECTION, Mounting Plate: L2" H4"

### Tiebacks



9060  
P3 1/2"

1263 P3"  
Single Traverse /  
Rod Combination

### Brackets

9010 P3"



9011 P6"



9012 P3" & P6"



Also available as P6"  
Single and P3" & P6"  
Double Traversing  
Brackets

### Baton

Specify Ring  
or Clip



9050  
5/8" DIA  
Available in  
38" Long Only

### Rings



9025  
ROUND  
5/8" THICK



9029  
FLAT  
3/4" WIDE



8006  
TROPICAL FINISH  
SELECTOR SET

### Finishes

Also available in  
High Gloss Finishes.  
Please add 20%  
upcharge.



TC201  
YELLOW TIGER



TC202  
BLACK TIMOR



TC203  
NATURAL BROWN



TC204  
RED BAMBUSSA



TC205  
GREEN CANE



TC206  
RUSTIC BAMBOO

...in your home!

# Burgundy Collection

## Hand Crafted Decorative Rods



251 VINEYARD H3½"



251B (BENT)  
VINEYARD H3½"  
Curve as per template



252 SOLID BRANCH, Approx. H3"



253 SOLID SNAKE, ⅝" DIA, Approx. H2"



254 ROUND WRAPPED  
WITH GRAPEVINE LEAVES  
¾" Shown, Approx. H10"



254B (BENT) ROUND WRAPPED WITH GRAPEVINE LEAVES  
¾" Shown, Approx. H10"  
Curve as per template



255 WOODGRAIN, ⅝" Solid or ⅞" Solid Only, P3" Brackets Included, Birds (#929) at Additional Charge, Approx. H9"



256 GRAPEVINE CURVED  
¼" Solid, P3" Brackets Included  
Approx. H8"

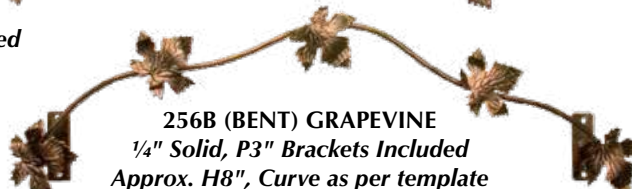

256B (BENT) GRAPEVINE  
¼" Solid, P3" Brackets Included  
Approx. H8", Curve as per template

¾" to 2" Round Hollow Rods are included in the price for #254 and #254B. Order brackets separately for #252, #253, #254, and #255B.

# Burgundy Collection

## Hand Crafted Decorative Rods

264 ROD WITH RETURN



Rod with Returns: Standard P3" or P6" in Round or Square rods and sockets available in Round, Square or Vertical Back Plates. Please refer to page 32 and 33 of IA Price List for line drawings

Measurements are based from the outside of the left socket to the outside of the right socket.



264D  
DECORATIVE ROD WITH RETURN  
Shown as 1 1/2" Dia, Approx. H10"



257 ROSEVINE LEAVES  
1/4" Solid, P3" Brackets Included Approx. H6"

A template, as applicable must be provided for production purposes.



257B (BENT) ROSEVINE LEAVES  
1/4" Solid, P3" Brackets Included  
Approx. H6"



L=78" 280 ROMAN, Overall Length 78", Approx. H7 1/2" Above the Rod, Standard P3" or P6" Available



L=52" 281 ROMAN, Overall Length 52", Approx. H7 1/2" Above the Rod, Standard P3" or P6" Available



L=78" 282 SPANISH, Overall Length 78", Approx. H7 1/2" Above the Rod, Standard P3" or P6" Available



L=52" 283 SPANISH, Overall Length 52", Approx. H7 1/2" Above the Rod, Standard P3" or P6" Available



284 TWINE BRANCH  
Available in Any Length  
Approx. 5 1/2" Above the Rod without Birds  
Standard P3" or P6" Available  
Birds (#929) and Finials (#954) at Additional Charge



285 TWINE BRANCH  
Available in Any Length, Approx. 5 1/2" Above  
the Rod without Birds, Shown as Bypass System  
Standard P3" or P6" Available  
Birds (#929) and Finials (#954) at Additional Charge

3/4" to 2" Round Hollow Rods are included in the price for #264, #264D, #280, #281, #282, #283, #284, and #285. Order finials and rings separately.

...vineyards, glades and forests!

# Mediterranean Collection

## Lightweight Decorative Crowns

Mounting options include Flush, Wood Duster Bracket and Wall Bracket P3"

4001 SERVENA  
L38" H15"



4002 CASTILLA  
L30" H13"



4003 CAMILLA  
L33½" H8¾"



4004 SOFIA  
L28¼" H4"



4005 MALLORCA  
L29½" H14¾"



4006 VALENCIA  
L29½" H11"



4007 MINERVA  
L22" H10"



4008 ISABELLE  
L37½" H19½"



4009 ASHA  
L27" H14"



4010 SEVILLE  
L26½" H15½"



4011 MORNING GLORY  
L45½" H12½"

# Vienna Collection

## Decorative Scrolls

All measurements  
are from tip to tip.

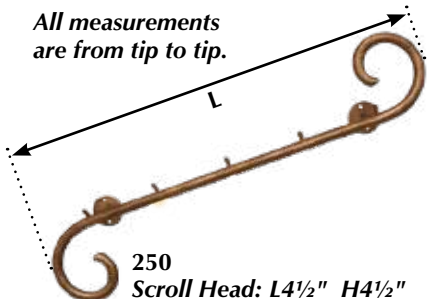

250  
Scroll Head: L4½" H4½"  
⅝" Solid, Min. Length 16"  
Shown as left.  
Knobs on front side.



266  
Bottom Scroll Head: L7½" H7"  
Top Scroll Head: L2½" H3½"  
Min. Length 17", Max. Length 48"  
Shown as left. Knobs on back side.



267  
Scroll Head: L7½" H7"  
Min. Length 27", Max. Length 48"  
Shown as left. Knobs on back side.



268  
Scroll Head: L5½" H6½"  
⅝" Solid, Min. Length 16"  
Shown as left.  
Knobs on front side.



270  
Scroll Head: H5½"  
⅝" Solid, Min. Length 16"  
Knobs on front side.



269  
Scroll Head: L4½" H6½"  
⅝" Solid, Min. Length 16"  
Shown as right.  
Knobs on front side.

# *Renaissance Collection*

## *Lightweight Decorative Cornices*

9125 CATHEDRAL L26½" H10" PER PANEL (Shown with 3 panels)



9126 PONTALBA L25¼" H8½" PER PANEL (Shown with 3 panels)



9127 NEW ORLEANS L27½" H8½" PER PANEL (Shown with 3 panels)



9128 GOTHIC L27¾" H11" PER PANEL (Shown with 3 panels)

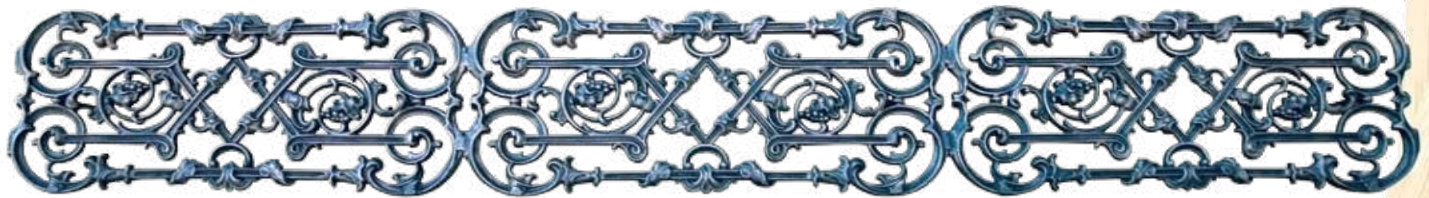

9129 FLORENCE L27¼" H11¼" PER PANEL (Shown with 3 panels)



9130  
RETURNS WITH  
MOUNTING  
PLATES UP TO 6"



Decorative Cornice shown with  
6" returns and mounting plates.  
(Shown with 1 panel)

*... classy and timeless!*

*Tuscany Collection*  
*Lightweight Decorative Metal Cornices*  
Available While Supplies Last.



# Tuscany Collection

## Lightweight Decorative Metal Cornices

Available While Supplies Last.

NARROW (27/8" - 33/4")

8021 ACANTHUS SINGLE H 3 1/2" (Shown in Bronze Vecchio)

8022 ACANTHUS DOUBLE H 7"



8023 TULIP SINGLE H 3 1/2" (Shown in Cherry Gold)

8024 TULIP DOUBLE H 7"



8034 SPRING LEAF SINGLE H 3 3/4" (Shown in Gold Antique White)

8035 SPRING LEAF DOUBLE H 7 1/2"



8026 BAROQUE SINGLE H 3 3/8" (Shown in Rusty)

8027 BAROQUE DOUBLE H 6 3/4"



8036 SEA SHORE SINGLE H 3 3/4" (Shown in Cherry Gold)



8028 EMBOSSED SINGLE H 2 7/8" (Shown in Antique Bronze)

8029 EMBOSSED DOUBLE H 5 3/4"



8055 INFINITE GEOMETRY SINGLE H 3 5/8" (Shown in Antique Gold)

8056 INFINITE GEOMETRY DOUBLE H 7 1/4"



8030 BUD BRANCH SINGLE H 3 1/2" (Shown in Antique Gold)

8031 BUD BRANCH DOUBLE H 7"



8057 CLASSIC SINGLE H 3 1/2" (Shown in Burnt Gold)

8058 CLASSIC DOUBLE H 7"



8032 SPANISH SCROLL SINGLE H 3 1/2" (Shown in Antique Bronze)

8033 SPANISH SCROLL DOUBLE H 7"



8059 ROYAL ROAD SINGLE H 3 1/2" (Shown in Autumn)

8060 ROYAL ROAD DOUBLE H 7"



# Tuscany Collection

## Lightweight Decorative Metal Cornices

Available While Supplies Last.

MEDIUM (4" - 5½")

8037 BASKET WEAVE H 5½" (Shown in Rich Gold)



8067 OLIVE BRANCHES SINGLE H 4¾" (Shown in Antique Copper)

8068 OLIVE BRANCHES DOUBLE H 8¾"



8061 BAMBOO DELIGHT SINGLE H 4⅛" (Shown in Bronze Patina)

8062 BAMBOO DELIGHT DOUBLE H 8¼"



8069 EMBLEM SINGLE H 4¼" (Shown in Sage Gold)

8070 EMBLEM DOUBLE H 8¼"



8063 Sunbursts SINGLE H 4⅛" (Shown in Antique Bronze)

8064 SUNBURSTS DOUBLE H 8¼"



8071 SWIRLS SINGLE H 4⅛" (Shown in Antique White)

8072 SWIRLS DOUBLE H 8¼"



8065 METAL WEAVE SINGLE H 4⅛" (Shown in Soft Pewter)

8066 METAL WEAVE DOUBLE H 8¼"



8073 Windblown SINGLE H 4" (Shown in Antique Copper)

8074 Windblown DOUBLE H 8"





# Tuscany Collection

## Lightweight Decorative Metal Cornices

Available While Supplies Last.

TALL (6" - 8")

8025 HAMMERED SINGLE H 8" (Shown in Soft Pewter)

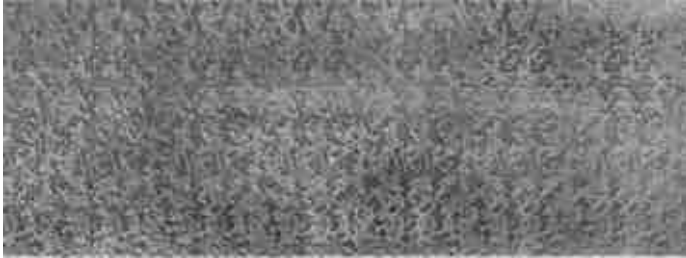

8077 LATTICE WEAVE H 6 1/8" (Shown in Bronze Vecchio)



8075 PYRAMIDS H 6" (Shown in Vecchio Patina)



8079 MOSAICS H 6" (Shown in Versace)



### CORNICE OPTIONS



All Designs can be bent (8044)

# Manual and Motorized Traversing



Orion's traversing systems come with many great features, plus plenty of options to choose from.

When using traversing, draperies will open and close easier than traditional rod and ring combinations through the use of heavy-duty glides, tracks and pulleys. With these heavy-duty systems you can safely hang up to 62 pounds of drapes on a 16 foot track; great in these days of lining and interlining. Single or double track systems up to 30 feet in length allow for a wide range of drapery styles. Front tracks are available with or without rings.



Our cord or baton drawn traversing collections include Designers' Choice (Iron, Wood, and Italian fascia styles), Tuscany Traversing (lightweight embossed metal rods), and Deco Lite Traversing (lightweight embossed metal panels). All these collections can be motorized with Somfy.

Orion offers nearly 200 different finials and 52 beautiful finishes to compliment your traversing system. You can even do your own custom finish. With so many options to choose from, you're sure to create that perfect design!



## DESIGNERS' CHOICE TRAVERSING RODS

Single and Double Traversing Sets  
in Iron, Italian, and Wood Fascia Styles.

***Iron and Italian - pages 44-45***

***Wood - pages 72-73***



## TUSCANY TRAVERSING

Single and Double Traversing Sets with  
Lightweight Embossed Metal Rod Designs.

***Available While Supplies Last.***

***pages 46-48***

## TRAVERSING ACCESSORIES

Rings, Batons, Glides, Etc.

***page 49***

# *Manual and Motorized Traversing*

## DECO LITE TRAVERSING

Single and Double Traversing Sets with  
Lightweight Embossed Metal Panel Designs.

*Available While Supplies Last.*

***pages 50-51***

TRAVERSING WITH  
SOMFY MOTORIZATION  
Motorization for Traversing Collections.

***pages 52-55***

SOMFY ACCESSORIES  
Control Options, Rings, Glides, Etc.

***pages 56-57***



# Designers' Choice Traversing Rods

## SAMPLE SINGLE CONFIGURATIONS

Available in 1½" and 2" diameters.



Available traversing sets without rings



**Shown:**  
**Finial:** 946-Small 2" Diameter  
**Rod:** 1½" Round Traversing Rod  
**Ring:** IT350TR - Smooth Ring  
**Set Finish:** Rusty  
**Track Finish:** Black  
**Draw Opening:** Center Open



Set: ITRR-S

Also available in 3" diameter

Available in Iron Art™ or Italian Collection Finishes.



Available traversing sets without rings



**Shown:**  
**Finial:** 947L  
**Rod:** 2" Square Traversing Rod  
**Ring:** IT352TR - Square Ring  
**Set Finish:** Soft Pewter  
**Track Finish:** Black  
**Draw Opening:** Center Open



Set: ITSQ-S

Available in Iron Art™ or Italian Collection Finishes.



Available traversing sets without rings



**Shown:**  
**Finial:** 946H-Medium 3" Diameter  
**Rod:** 2" Round Hammered Traversing Rod  
**Ring:** IT356TR - Hammered Ring  
**Set Finish:** Bronze Patina  
**Track Finish:** Antique Bronze  
**Draw Opening:** Center Open



Set: ITRH-S

Also available in 3" diameter



**Shown:**  
**Finial:** 906S  
**Rod:** 1½" Fluted Traversing Rod  
**Set Finish:** Vecchio Patina  
**Track Finish:** Antique Bronze  
**Draw Opening:** Right Stack



Set: ITFL-S

Automatically includes heavy duty track at no extra charge. Finials, rings, and batons sold separately. Glides are available in white, black, antique bronze or gold. • All end pulleys are available only in white. All traversing tracks can be mitered, Round and Round Hammered only can be Bent or Curve.

# Designers' Choice Traversing Rods

## SAMPLE DOUBLE CONFIGURATIONS

Available: Front Rod in 1½" and 2" diameters. Back Rod in 1¼" diameter only.



*Available traversing sets without rings*



**Shown:**  
 Finial: 946-Large 4" Diameter  
 Front Rod: 3" Round Traversing Rod  
 Back Rod: Track Only  
 Ring: IT350TR - Smooth Ring  
 Set Finish: Rich Gold  
 Track Finish: Gold  
 Draw Opening: Right Stack  
 Available in Iron Art™ or Italian Collection Finishes.



Set: ITRR-D

*Also available in 3" diameter*



*Available traversing sets without rings*



**Shown:**  
 Finial: 7006L  
 Front Rod: 2" Square Traversing Rod  
 Back Rod: 1¼" Square Traversing Rod  
 Ring: IC352TR - Square Ring  
 Set Finish: Brushed Nickel  
 Track Finish: White  
 Draw Opening: Center Open  
 Available in Iron Art™ or Italian Collection Finishes.



Set: ICSQ-D

*\*Italian Collection Iron Traversing Set*



*Available traversing sets without rings*



**Shown:**  
 Finial: 908  
 Front Rod: 2" Round Hammered Traversing Rod  
 Back Rod: 1¼" Round Hammered Traversing Rod  
 Ring: IT356TR - Hammered Ring  
 Set Finish: Burnt Gold  
 Track Finish: Antique Bronze  
 Draw Opening: Center Open



Set: ITRH-D

*Also available in 3" diameter*



**Shown:**  
 Finial: 903  
 Front Rod: 2" Fluted Traversing Rod  
 Back Rod: 1¼" Fluted Traversing Rod  
 Set Finish: Cherry Gold  
 Track Finish: Gold  
 Draw Opening: Left Stack



Set: ITFL-D

*Automatically includes heavy duty track at no extra charge. Finials, rings, and batons sold separately. Glides are available in white, black, antique bronze or gold. • All end pulleys are available only in white. All traversing tracks can be mitered, Round and Round Hammered only can be Bent or Curve.*

# Tuscany Traversing Collection

## Lightweight Embossed Metal Rods

Available While Supplies Last.

### SAMPLE MANUAL CONFIGURATIONS: CORDED



#### SINGLE TUSCANY TRAVERSING

Finial: 947                      Rod Fascia Design: TT8055 Infinite Geometry  
Set Finish: Antique Copper      Draw Opening: Right Stack



*Available traversing sets without rings*

#### SINGLE TUSCANY TRAVERSING WITH RINGS

Finial: 903                      Rod Fascia Design: TT8023 Tulip  
Set Finish: Antique White      Draw Opening: Right Stack



#### DOUBLE TUSCANY TRAVERSING

Finial: 414                      Rod Fascia Design: TT8021 Acanthus  
Set Finish: Antique Bronze      Draw Opening: Center Open



*Available traversing sets without rings*

#### DOUBLE TUSCANY TRAVERSING WITH RINGS

Finial: 418                      Rod Fascia Design: TT8034 Spring Leaf  
Set Finish: Bronze Patina      Draw Opening: Center Open



# *Tuscany Traversing Collection*

## *Lightweight Embossed Metal Rods*

Available While Supplies Last.

### FASCIA DESIGNS

**TT8021 ACANTHUS H 2½"** (Shown in Bronze Vecchio)



**TT8023 TULIP H 2½"** (Shown in Cherry Gold)



**TT8034 SPRING LEAF H 2¾"** (Shown in Gold Antique White)



**TT8026 BAROQUE H 2⅜"** (Shown in Rusty)



**TT8036 SEA SHORE H 2¾"** (Shown in Cherry Gold)



**TT8028 EMBOSSED H 1⅞"** (Shown in Antique Bronze)



**TT8055 INFINITE GEOMETRY H 2⅝"** (Shown in Antique Gold)



**TT8030 BUD BRANCH H 2½"** (Shown in Antique Gold)



**TT8057 CLASSIC H 2½"** (Shown in Burnt Gold)



**TT8032 SPANISH SCROLL H 2½"** (Shown in Antique Bronze)



**TT8059 ROYAL ROAD H 2½"** (Shown in Autumn)



# Tuscany Traversing Collection

## Lightweight Embossed Metal Rods

Available While Supplies Last.

### SAMPLE MOTORIZED CONFIGURATIONS

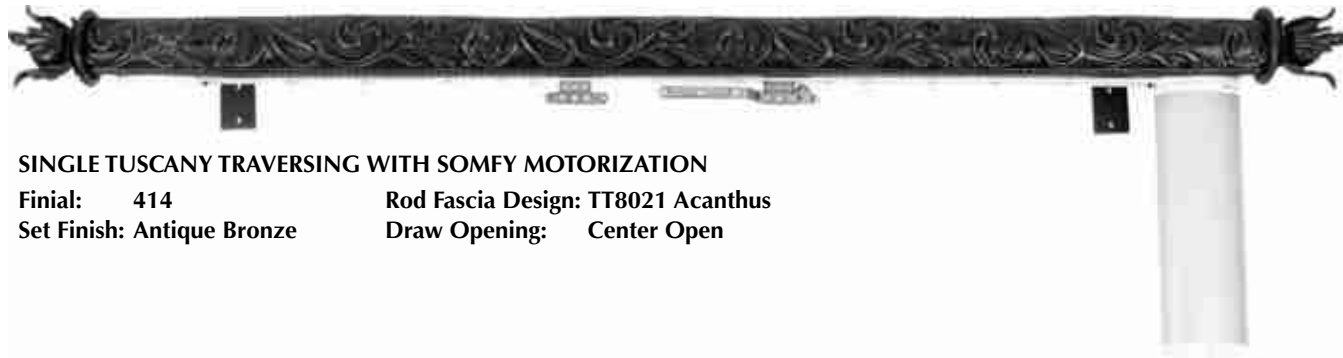

SINGLE TUSCANY TRAVERSING WITH SOMFY MOTORIZATION

Finial: 414

Rod Fascia Design: TT8021 Acanthus

Set Finish: Antique Bronze

Draw Opening: Center Open

### TUSCANY TRAVERSING OPTIONS

#### TRACK SYSTEMS



#### RING OPTIONS



#### BENT OPTION *(Rod may be bent or curved.)*





# Traversing Accessories

## HEAVY DUTY BRACKETS

WALL MOUNT  
End Brackets



**1048EBS**  
SINGLE  
END BRACKET  
*Vertical back plate*

**1049EBD**  
DOUBLE  
END BRACKET  
*Vertical back plate*

WALL MOUNT  
Support Brackets



**1050SBS**  
SINGLE SUPPORT  
BRACKET  
*Horizontal back plate*

**1051SBD**  
DOUBLE SUPPORT  
BRACKET  
*Horizontal back plate*

CEILING MOUNT  
End & Support Brackets



**1052CBS**  
SINGLE BRACKET  
*Horizontal top plate*

**1053CBD**  
DOUBLE BRACKET  
*Horizontal top plate*

## TRACKS AVAILABLE IN:



ANTIQU  
BRONZE

BLACK

GOLD

SILVER

WHITE

## BATONS



**IT1016BT**  
IRON BATON  
1/2" DIA.  
Available from  
48" - 72"

**IT1020BT**  
IRON BATON  
WITH WOODEN  
HANDLE  
1/2" DIA.  
Available from  
48" - 72"

## PINCH PLEAT GLIDES FOR SYSTEMS USING RINGS



PINCH PLEAT GLIDES FOR  
SYSTEMS WITHOUT RINGS  
*Available in white color only*



TRAVERSING CLIPS  
*For spliced facia*



ROUND

SQUARE

RIPPLEFOLD GLIDES  
*Available in white color only*



## "C" RINGS

IRON

ITALIAN

WOOD



**IT350TR** **IT352TR** **IT356TR** **IC350TR** **IC352TR** **WT5047TR** **WT5049TR**  
ROUND SQUARE HAMMERED ROUND SQUARE SMOOTH FLUTED

# *Deco Lite Traversing* *Lightweight Embossed Metal Panels*

Available While Supplies Last.

## SAMPLE MANUAL CONFIGURATIONS: CORDED



**SINGLE MANUAL TRAVERSING**  
Set Finish: Bronze Vecchio  
Fascia Design: DT8021 Acanthus  
Draw Opening: Right Stack



**DOUBLE MANUAL TRAVERSING**  
Set Finish: Naturelle  
Fascia Design: DT8055 Infinite Geometry  
Draw Opening: Right Stack

## SAMPLE MOTORIZED CONFIGURATIONS



**SINGLE MOTORIZED TRAVERSING**  
Set Finish: Golden Oak  
Fascia Design: DT8059 Royal Road  
Draw Opening: Right Stack



**DOUBLE MOTORIZED TRAVERSING**  
Set Finish: Antique Gold  
Fascia Design: DT8034 Spring Leaf  
Draw Opening: Right Stack



# Deco Lite Traversing

## Lightweight Embossed Metal Panels

Available While Supplies Last.

### FASCIA DESIGNS

DT8021 ACANTHUS H 3½" (Shown in Bronze Vecchio)



DT8023 TULIP H 3½" (Shown in Cherry Gold)



DT8034 SPRING LEAF H 3¾" (Shown in Gold Antique White)



DT8026 BAROQUE H 3⅝" (Shown in Rusty)



DT8036 SEA SHORE H 3¾" (Shown in Cherry Gold)



DT8028 EMBOSSSED H 2⅞" (Shown in Antique Bronze)



DT8055 INFINITE GEOMETRY H 3⅝" (Shown in Antique Gold)



DT8030 BUD BRANCH H 3½" (Shown in Antique Gold)



DT8057 CLASSIC H 3½" (Shown in Burnt Gold)



DT8032 SPANISH SCROLL H 3½" (Shown in Antique Bronze)



DT8059 ROYAL ROAD H 3½" (Shown in Autumn)



### DECO LITE TRAVERSING OPTIONS

#### TRACK SYSTEMS

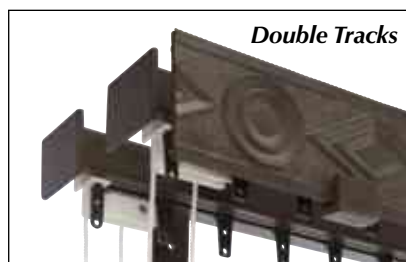

See pages 52-57

# *Traversing with Somfy Motorization*



**TRAVERSING WITH SOMFY**  
CHOOSE. TOUCH. RELAX.™

# Traversing with Somfy Motorization

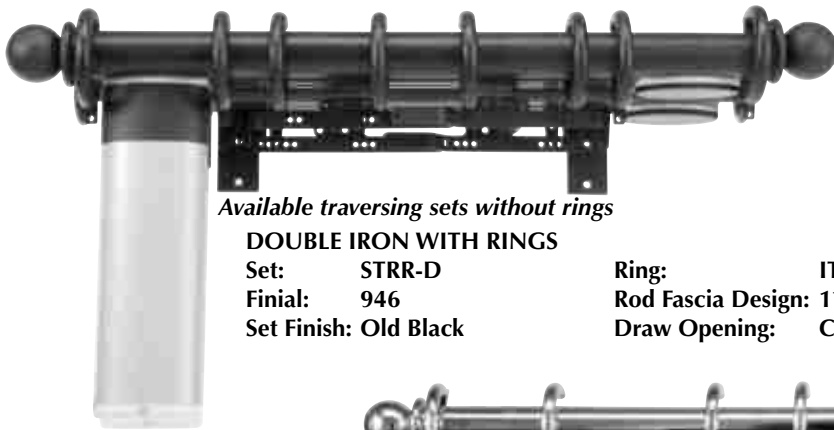

Available traversing sets without rings

## DOUBLE IRON WITH RINGS

Set: STRR-D

Finial: 946

Set Finish: Old Black

Ring:

IT350TR - Round Traversing Ring

Rod Fascia Design: 1½" DIA. Round Traversing Rod

Draw Opening: Center Open



Available traversing sets without rings

## DOUBLE ITALIAN WITH RINGS

Set: STIR-D

Finial: 946

Set Finish: Polished Chrome

Ring:

IT350TR - Round Traversing Ring

Rod Fascia Design: 1½" DIA. Round Traversing Rod

Draw Opening: Center Open



Available traversing sets without rings

## SINGLE IRON WITH RINGS

Set: STRH-S

Finial: 946H

Set Finish: Naturelle

Ring:

IT356TR - Hammered Traversing Ring

Rod Fascia Design: 1½" DIA. Round Hammered Traversing Rod

Draw Opening: Center Open



## SINGLE ITALIAN WITHOUT RINGS

Set: STIQ-S

Finial: 782

Set Finish: Brushed Nickel

Rod Fascia Design: 2" DIA. Square Traversing Rod

Draw Opening: Center Open



## SINGLE IRON WITHOUT RINGS

Set: STSQ-S

Finial: 947L

Set Finish: Oil Rubbed Bronze

Rod Fascia Design: 2" DIA. Square Traversing Rod

Draw Opening: Center Open

# Traversing with Somfy Motorization



## SINGLE WOOD WITHOUT RINGS

Set: STSM-S

Finial: 5028

Set Finish: Aged Pewter

Rod Fascia Design: 2 1/4" DIA. Smooth Traversing Rod

Draw Opening: Right Stack



## DOUBLE WOOD WITHOUT RINGS

Set: STWF-D

Finial: 5024

Set Finish: Mahogany

Rod Fascia Design: 2 1/4" DIA. Fluted Traversing Rod

Draw Opening: Left Stack



## SINGLE TUSCANY TRAVERSING WITHOUT RINGS *(Available While Supplies Last)*

Set: TTST-S

Finial: 906S

Set Finish: Burnt Gold

Rod Fascia Design: TT8028 Embossed

Draw Opening: Center Open



## TUSCANY TRAVERSING CURVED ROD *(Available While Supplies Last)*

Set: TTST-S with curve *(Additional charges apply)*

Finial: 990

Set Finish: Golden Oak

Rod Fascia Design: TT8030 Bud Branch

Draw Opening: Center Open



## TRACK ONLY

Set: ST35-S (for 35 RTS Motor) / ST60E-S (for 60e RTS Motor)

Draw Opening: Right Stack

# Traversing with Somfy Motorization

## TRAVERSING WITH SOMFY OPTIONS

### FASCIA OPTIONS



### TRACK SYSTEMS

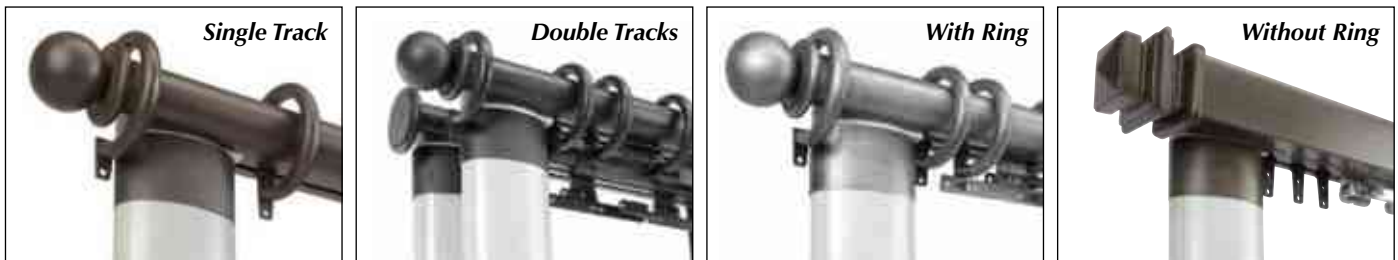

### RING OPTIONS

### ADDITIONAL INFORMATION



# Traversing with Somfy Motorization

With Somfy's line of motors, simply press a button on your wireless wall switch, hand-held remote control, or the myLink™ App for your phone or tablet and your motorized curtains open smoothly and quietly.

## MOTORS



**Glydea 60e  
SMTR60E**

- Plugs Directly into Standard 110 V AC Duplex Wall Outlet (Comes with 10 Ft. Plug).
- Traverses up to 132 Lbs.

**Glydea 35e  
SMTR35E**

- Plugs Directly into Standard 110 V AC Duplex Wall Outlet (Comes with 10 Ft. Plug).
- Traverses up to 77 Lbs.



**Irismo 35 Mini DC  
SMTR35M**

- 24V DC Low Voltage Power Supply with 13.2 Ft. Cord.
- Traverses up to 77 Lbs.



**Irismo 45 WireFree  
SMTR45M**

- Powered by a Rechargeable 26.5V Lithium Ion Battery.
- Extra Batteries Available. (SMTR45WBAT)
- Charger Sold Separately. (SMTR45WCHG)
- Traverses up to 99 Lbs.



## CONTROL OPTIONS AND ACCESSORIES

### DECOFLEX WIREFREE RTS WALL SWITCHES

#### White Finish



**STSW1-WH**  
1 Track  
1 Channel

**STSW5-WH**  
1-5 Tracks  
5 Channels

#### Ivory Finish

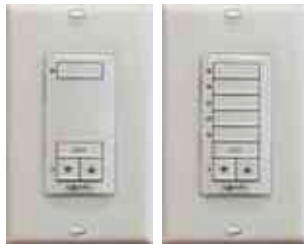

**STSW1-IV**  
1 Track  
1 Channel

**STSW5-IV**  
1-5 Tracks  
5 Channels

#### Black Finish



**STSW1-BL**  
1 Track  
1 Channel

**STSW5-BL**  
1-5 Tracks  
5 Channels

### SOMFY SUNIS INDOOR (RTS) WIREFREE SENSORS



**SUNIS-SUN**  
Sun Sensor Only  
unlimited tracks  
multi-channel

**SUNIS-TMP**  
Sun & Temp. Sensor  
unlimited tracks  
multi-channel

### TELIS 1 CHRONIS RTS

#### Silver Star Finish



**STRP1-SS**  
1 Track / 1 Channel  
Single Channel  
Zone Control &  
Programmable Timer

### SITUO RTS REMOTE CONTROL

#### Pure Finish



**STRP1-PR**  
1 Track  
1 Channel

#### Silver Finish



**STRP5-PR**  
1-5 Tracks  
5 Channels

#### Silver Finish



**STRP1-SL**  
1 Track  
1 Channel

#### Silver Finish



**STRP5-SL**  
1-5 Tracks  
5 Channels

#### Lounge Finish



**STRP1-LO**  
1 Track  
1 Channel

#### Lounge Finish



**STRP5-LO**  
1-5 Tracks  
5 Channels

### SOMFY MYLINK™ RTS



**STAPP**  
5 Channels  
Control Somfy motors through a smart phone or tablet. Consists of a simple plug-in device and free app. Does not replace a preprogrammed RTS control.

### DECOFLEX TABLE TOP ACCESSORIES



**Black Finish**  
**STTABLE-BL**  
with STSW1-BL

**Silver Finish**  
**STTABLE-SL**  
with STSW1-BL





# Traversing with Somfy Motorization

## HEAVY DUTY BRACKETS

### WALL MOUNT End Brackets



**1048EBSS**  
SINGLE  
END BRACKET  
Vertical back plate

**1049EBSD**  
DOUBLE  
END BRACKET  
Vertical back plate

### WALL MOUNT Support Brackets



**1050SBSS**  
SINGLE SUPPORT  
BRACKET  
Horizontal back plate

**1051BSD**  
DOUBLE SUPPORT  
BRACKET  
Horizontal back plate

### CEILING MOUNT End & Support Brackets



**1052CBSS**  
SINGLE BRACKET  
Horizontal top plate

**1053CBD**  
DOUBLE BRACKET  
Horizontal top plate

## TRACKS AVAILABLE IN:



ANTIQUÉ  
BRONZE

BLACK

GOLD

SILVER

WHITE

## TRAVERSING CLIPS For spliced fascia



ROUND

SQUARE

## PINCH PLEAT GLIDES FOR SYSTEMS USING RINGS



## PINCH PLEAT GLIDES FOR SYSTEMS WITHOUT RINGS



Available in white color only

## RIPPLEFOLD GLIDES AND SNAP TAPE



Available in white color only

## "C" RINGS

### IRON



IT350STR  
ROUND

IT352STR  
SQUARE

### ITALIAN



IT356STR  
HAMMERED



IC350STR  
ROUND



IC352STR  
SQUARE

### WOOD



WT5047STR  
SMOOTH



WT5049STR  
FLUTED

# Italian Collection

## Metal Plated Iron Drapery Hardware

All Finials: Interior fit only. Available in 3/4", 1", and 1 1/4" diameter only.



Options  
7002 1 1/2" DIA  
7003\* 2" DIA

Finial: 7002  
Finish: Brushed Nickel

1 1/2" DIA

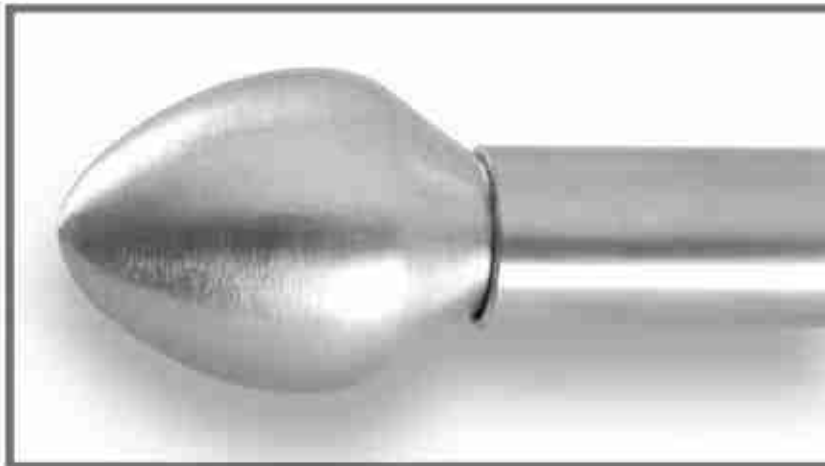

Finial: 7001  
Finish: Brushed Nickel

L 1 3/4" H 1 1/4"



Options  
7005 L 2" H 1 1/8"  
7005L\* L 3" H 1 3/4"

Finial: 7005  
Finish: Brushed Nickel

L 2" H 1 1/8"



Finial: 7004  
Finish: Polished Chrome

L 2" H 1 1/8"

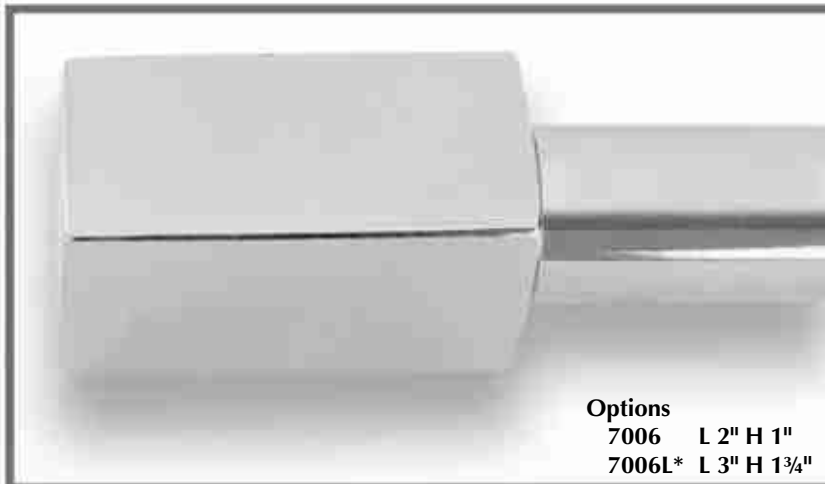

Options  
7006 L 2" H 1"  
7006L\* L 3" H 1 3/4"

Finial: 7006  
Finish: Polished Chrome

L 2" H 1"

# *New Finial Designs*

## *3 New Designs for the Italian Collection*

We've expanded our Italian Collection with three new finial designs for you to choose from. These modern styles combine the sleek sophistication of plated metal with the timelessness of wood. Finials are available in two different sizes. Choose from six Italian finishes for the metal and three wood finishes for the insert. Interior fit only. Available for 3/4", 1", and 1 1/4" diameter rods. Not available for Traversing Rods. Available While Supplies Last.



**Finial 7070L**  
 3 3/4" Long x 1 3/8" High  
 Shown in Polished Chrome (IT 206) on a  
 1" round rod with Walnut stained wood insert.



**Finial 7070**  
 3 3/8" Long x 1" High  
 Shown in Brushed Nickel (IT 201) on a  
 1" round rod with Oak stained wood insert.

### Horizontal Lines



**Finial 7071L**  
 3 3/4" Long x 1 3/8" High  
 Shown in Polished Chrome (IT 206) on a  
 1" round rod with Natural stained wood insert.



**Finial 7071**  
 3 3/8" Long x 1" High  
 Shown in Brushed Nickel (IT 201) on a  
 1" round rod with Walnut stained wood insert.

### Slat Lines



**Finial 7072L**  
 3 3/4" Long x 1 3/8" High  
 Shown in Polished Chrome (IT 206) on a  
 1" round rod with Oak stained wood insert.



**Finial 7072**  
 3 3/8" Long x 1" High  
 Shown in Brushed Nickel (IT 201) on a  
 1" round rod with Natural stained wood insert.

### Wavy Lines

## AVAILABLE WOOD INSERT FINISHES



Natural



Oak

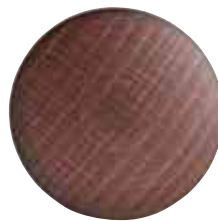

Walnut

# Italian Collection

## Metal Plated Iron Drapery Hardware



### ROUND RODS

7019 3/4" DIA • 7020 1" DIA • 7023 1 1/4" DIA  
(Shown in Brushed Nickel)

### SQUARE RODS

7021 3/4" DIA • 7022 1" DIA • 7024 1 1/4" DIA  
(Not Shown)



### 7321 END CAPS

(Left: Polished Chrome  
Right: Brushed Nickel)  
Available in Round only



### 7016 END CAPS

Available for Round or Square Rods  
(Left: Brushed Nickel  
Right: Polished Chrome)

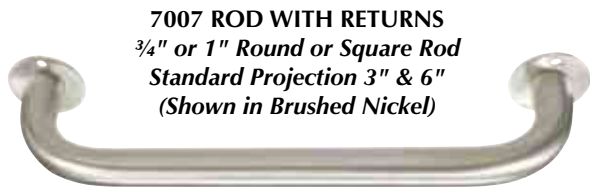

### 7007 ROD WITH RETURNS

3/4" or 1" Round or Square Rod  
Standard Projection 3" & 6"  
(Shown in Brushed Nickel)



### 7187

"U" SHAPE BEND  
Projection 3 1/2"  
(Shown in  
Brushed Nickel)

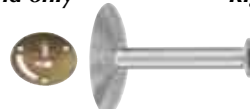

### 7188FX POST PROJECTION BACK PLATE

Fixed Projections in 3", 4" or 6 1/2"  
Includes Mounting Plate  
(Shown in Brushed Nickel)

1014  
BATON  
Specify Ring or Clip  
(Shown in Polished  
Chrome)



### SINGLE 3"P BRACKETS - Available for Round or Square Rods



7014  
END BRACKET  
(Shown in  
Polished Chrome)



7014HP  
SUPPORT BRACKET  
(Shown in Brushed Nickel)



7035  
CEILING BRACKET  
(Shown in Brushed Nickel)



7038  
3"P EYELET BRACKET  
(Shown in Brushed Nickel)



7039  
6"P EYELET BRACKET  
(Not Shown)

### SINGLE 6"P BRACKETS - Available for Round or Square Rods



7015  
END BRACKET  
(Shown in Polished Chrome)



7015HP  
SUPPORT BRACKET  
(Shown in Brushed Nickel)

SOCKETS  
Available for Round  
or Square Rods  
(Shown in Polished  
Chrome)

7012  
(Shown in  
Brushed Nickel)

### DOUBLE BRACKETS



7040  
3" & 6"P DOUBLE BRACKET  
Available for Round or Square Rods  
(Shown in Polished Chrome)



7036  
3" & 6"P DOUBLE CEILING BRACKET  
(Shown in Brushed Nickel)



7010

7011

7016



7013  
(Shown in  
Polished Chrome)



45°



90°

### 7009

Available for Round or Square Rods  
(Shown in Brushed Nickel)



### 7017

CORNER BRACKET  
(Shown in Brushed Nickel)



### 7018

MOVABLE ELBOW  
Shown in 3/4"; Interior Fit Only  
(Shown in Polished Chrome)  
Available with hinge, item # 7018-H,  
similar to iron item #320 on page 19

# Unique Collection: Italian Bypass System with "C" Rings

Available in 3/4", 1", and 1 1/4" diameters. Straight Round Hollow Rods only.  
Available in all Iron Art™ and Italian Collection finishes. Shown in Brushed Nickel.



## RINGS



**7330C**  
"C" RING  
(Shown in  
Polished Chrome)

Single Rod System

Double Rod System

## BRACKETS



**7014SE**  
3\"/>



**7015SE**  
6\"/>



**7040DE**  
3\"/>



**7318-3P**  
3\"/>

Horizontal Plate Bottom Weld  
is available (7318-HP-3\"/>



**7318-6P**  
6\"/>

Horizontal Plate Bottom Weld  
is available (7318-HP-6\"/>



**7319**  
3\"/>

## ITALIAN FINISHES



Brushed Nickel  
IT 201 - Group I



Polished Chrome  
IT 206 - Group J



Black Nickel  
IT 202 - Group K



Oiled Bronze  
IT 203 - Group K



Satin Copper  
IT 204 - Group K



Satin Gold  
IT 205 - Group K



Polished Nickel  
IT 207 - Group J



Black Chrome  
IT 208 - Group L



Polished Brass  
IT 209 - Group L



Satin Brass  
IT 210 - Group L



Antique Brass  
IT 211 - Group L



Polished Rose Gold  
IT 212 - Group L



Satin Rose Gold  
IT 213 - Group L

# Bohemia Collection

## Decorative Hand Crafted Faceted Crystal-Glass Finials

Available in Iron Art™ Finishes, Italian Finishes, or Your Own Custom Finish. Interior Fit Only. Also For Use as Tiebacks.

FINIALS TO FIT 3/4", 1", & 1 1/4" DIAMETER ROUND & SQUARE HOLLOW IRON RODS, OR 1 1/2" TRAVERSING RODS.



**Finial 790**

3/4" Long x 2" High - 2" at Base  
Shown in Antique Gold (06)

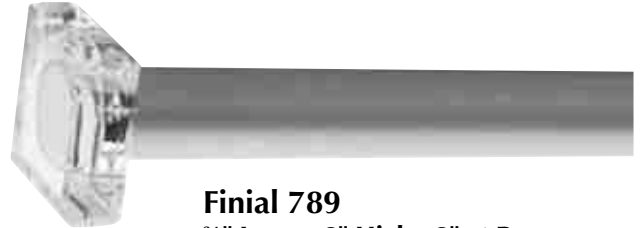

**Finial 789**

3/4" Long x 2" High - 2" at Base  
Shown in New Nickel (12)



**Finial 778**

1 1/4" Long x 2 3/8" High - 1 1/2" at Base  
Shown in Oiled Bronze (IT 203)



**Finial 768**

1 7/8" Long x 2 1/2" High - 1 5/8" at Base  
Shown in Rich Gold (07)



**Finial 766**

1 1/2" Long x 2 3/8" High - 2" at Base  
Shown in Antique Bronze (02)



**Finial 785**

2 1/2" Long x 1 1/2" High - 1 1/2" at Base  
Shown in Polished Chrome (IT 206)



**Finial 767**

3 1/4" Long x 2" High - 2" at Base  
Shown in Naturelle (03)



**Finial 769**

3 3/8" Long x 2 3/8" High - 1 3/4" at Base  
Shown in Oil Rubbed Bronze (34)



**Finial 765**

3 3/8" Long x 2 3/8" High - 1 1/2" at Base  
Shown in Soft Pewter (13)

# Bohemia Collection

## Decorative Hand Crafted Faceted Crystal-Glass Finials

Available in Iron Art™ Finishes, Italian Finishes, or Your Own Custom Finish. Interior Fit Only. Also For Use as Tiebacks.  
 FINIALS TO FIT 3/4", 1", 1 1/4", & 2" DIAMETER ROUND & SQUARE HOLLOW IRON RODS, OR 1 1/2" & 2" TRAVERSING RODS.

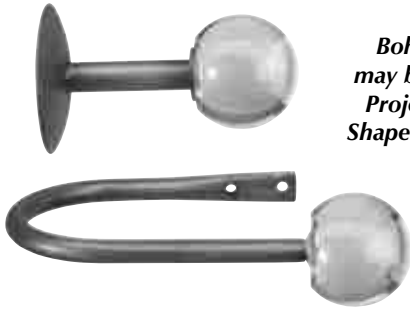

Bohemia Finials  
 may be used as Post  
 Projection or "U"  
 Shape Bend Tiebacks.

All are shipped  
 in custom boxes  
 to ensure high  
 quality protection.



**Finial 787**  
 3 1/2" Long x 2" High - 2" at Base  
 Shown in Antique Copper (10)



**Finial 783**  
 1 7/8" Long x 2" High - 2" at Base  
 Shown in Bronze Vecchio (15)



**Finial 782**  
 2 7/8" Long x 2 3/4" High - 1 5/8" at Base  
 Shown in Brushed Nickel (IT 201)



**Finial 786**  
 3" Long x 2 3/8" High - 2 3/8" at Base  
 Shown in a Burnt Silver (17)



**Finial 784**  
 2 3/8" Long x 2 7/8" High - 2 7/8" at Base  
 Shown in Old Black (01)



**Finial 791**  
 3 5/8" Long x 3 5/8" High - 2" at Base  
 Shown in Satin Copper (IT 204)

# Bohemia Collection

## Decorative Hand Crafted Faceted Crystal-Glass Finials

Available in Iron Art™ Finishes, Italian Finishes, or Your Own Custom Finish. Interior Fit Only. Also For Use as Tiebacks.

FINIALS TO FIT 3/4", 1", 1 1/4", & 2" DIAMETER ROUND & SQUARE HOLLOW IRON RODS, OR 1 1/2" & 2" TRAVERSING RODS.



**Finial 781**

2 1/8" Long x 2 3/8" High - 1 5/8" at Base  
Shown in *Antique White* (20)



**Finial 788**

3 1/2" Long x 2" High - 2" at Base  
Shown in *Black* (14)



**Finial 771**

2 3/8" Long x 2 1/4" High - 1 5/8" at Base  
Shown in *Antique Gold* (06)



**Finial 779**

1 1/2" Long x 3 1/8" High - 1 5/8" at Base  
Shown in *Satin Gold* (IT 205)



**Finial 776**

2 3/8" Long x 3 1/8" High - 2" at Base  
Shown in *Rich Gold* (07)



**Finial 763**

1 1/8" Long x 3 1/4" High - 3 1/4" at Base  
Shown in *Brushed Nickel* (IT 201)



**Finial 780**

3" Long x 3 1/8" High - 1 5/8" at Base  
Shown in *Brown* (19)



**Finial 792**

3 3/4" Long x 3 1/4" High - 2" at Base  
Shown in a *Burnt Silver* (17)



# Bohemia Collection

## Decorative Hand Crafted Faceted Crystal-Glass Finials

Available in Iron Art™ Finishes, Italian Finishes, or Your Own Custom Finish. Interior Fit Only. Also For Use as Tiebacks.  
FINIALS TO FIT 3/4", 1", 1 1/4", & 2" DIAMETER ROUND & SQUARE HOLLOW IRON RODS, OR 1 1/2" & 2" TRAVERSING RODS.



**Finial 774**  
2" Long x 2 3/4" High - 1 1/2" at Base  
*Shown in Rusty (04)*

One of the hallmarks of true faceted crystal-glass is that it shows changes and variations in color when viewed from different angles.



**Finial 764**  
3 5/8" Long x 2 1/2" High - 1 5/8" at Base  
*Shown in Bronze Vecchio (15)*



**Finial 773**  
2 3/4" Long x 2 3/8" High - 1 5/8" at Base  
*Shown in Antique Bronze (02)*

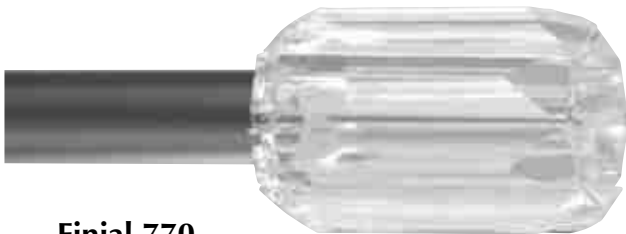

**Finial 770**  
3 5/8" Long x 2 1/2" High - 2 1/2" at Base  
*Shown in Naturelle (03)*



**Finial 772**  
2 3/4" Long x 2 3/8" High - 1 3/4" at Base  
*Shown in Soft Pewter (13)*



**Finial 775**  
2 3/4" Long x 2 1/2" High - 1 1/2" at Base  
*Shown in Oil Rubbed Bronze (34)*



**Finial 777**  
3" Long x 2 3/4" High - 2" at Base  
*Shown in Black Nickel (IT 202)*

# Wood Art™ by ORION

Our Wood Art™ collection was introduced to expand the hardware options we offered designers, adding the classic elegance of wood to our drapery hardware selection. Wood Art™ is a beautiful, versatile group that will enhance any designer's imaginative repertoire.

Crystal, wood, and resin finials designed to fit 1 3/8", 2", 2 1/4", or 3" poles are offered in a range of styles that will blend with or complement any décor. All are available in 35 Iron Art™ and 11 Wood Art™ finishes, as well as your own custom finish.

Wood Art™ features wood poles in smooth or fluted designs. There are two wood bracket styles and two wood ring styles to choose from. All our wood poles are also available with manual or motorized traversing.

Interested in an iron-wood fusion solution? Mix iron and wood together for a truly original look. Iron finials, rings, and brackets can all be incorporated for a one of a kind design.





## What's New

- New Bohemia Crystal Designs (68-71)

# *Bohemia on Wood Collection*

## *Decorative Hand Crafted Faceted Crystal-Glass Finials*

Available in Iron Art™ Finishes, Wood Art™ Finishes, or Your Own Custom Finish. Also For Use as Tiebacks.

**FINIALS TO FIT 1 3/8" DIAMETER WOOD POLES**

Bohemia hand-crafted faceted crystal-glass will add sparkle and shine to any space. With Bohemia Crystal's extensive variety of shapes, and our combinations of pole sizes and finishes, you can easily achieve a traditional, transitional or modern look.

Our beautiful, award winning Bohemia Crystals on wood are available in 7 designs that fit 1 3/8" wood poles, and 17 finial designs that fit 1 3/8", 2", and 2 1/4" wood poles. A finished metal collar creates a transition between the pole and finial. We offer smooth or fluted style poles in 11 gorgeous Wood Art™ finishes, 35 Iron Art™ finishes, or your own custom finish.



*All are shipped in custom boxes to ensure high quality protection.*



*Bohemia Finials may be used as Post Projection or "U" Shape Bend Tiebacks.  
Iron Post Projection and "U" Shape Bend Tiebacks are not available in Wood Art™ finishes.*



Available in Iron Art™ Finishes, Wood Art™ Finishes, or Your Own Custom Finish. Also For Use as Tiebacks.

**FINIALS TO FIT 1 3/8" DIAMETER WOOD POLES**



**Finial 767**

**3 1/4" Long x 2" High - 2" at Base**

***Shown on 1 3/8" Smooth Pole in Old Black (01)***

# *Bohemia on Wood Collection*

## *Decorative Hand Crafted Faceted Crystal-Glass Finials*

Available in Iron Art™ Finishes, Wood Art™ Finishes, or Your Own Custom Finish. Also For Use as Tiebacks.

FINIALS TO FIT 1<sup>3</sup>/<sub>8</sub>" DIAMETER WOOD POLES



**Finial 778**  
 1<sup>1</sup>/<sub>4</sub>" Long x 2<sup>3</sup>/<sub>8</sub>" High - 1<sup>1</sup>/<sub>2</sub>" at Base  
 Shown on 1<sup>3</sup>/<sub>8</sub>" Smooth Pole  
 in Mahogany (WC 103)



**Finial 790**  
 3/4" Long x 2" High - 2" at Base  
 Shown on 1<sup>3</sup>/<sub>8</sub>" Smooth Pole  
 in Old Black (01)



**Finial 768**  
 1<sup>7</sup>/<sub>8</sub>" Long x 2<sup>1</sup>/<sub>2</sub>" High - 1<sup>5</sup>/<sub>8</sub>" at Base  
 on 1<sup>3</sup>/<sub>8</sub>" Smooth Pole  
 in Rich Gold (07)



**Finial 766**  
 1<sup>1</sup>/<sub>2</sub>" Long x 2<sup>3</sup>/<sub>8</sub>" High - 2" at Base  
 Shown on 1<sup>3</sup>/<sub>8</sub>" Smooth Pole  
 in Soft Pewter (13)



**Finial 765**  
 3<sup>3</sup>/<sub>8</sub>" Long x 2<sup>3</sup>/<sub>8</sub>" High - 1<sup>1</sup>/<sub>2</sub>" at Base  
 Shown on 1<sup>3</sup>/<sub>8</sub>" Smooth Pole  
 in Antique Bronze (02)



**Finial 769**  
 3<sup>3</sup>/<sub>8</sub>" Long x 2<sup>3</sup>/<sub>8</sub>" High - 1<sup>3</sup>/<sub>4</sub>" at Base  
 Shown on 1<sup>3</sup>/<sub>8</sub>" Smooth Pole  
 in Bronze Vecchio (15)

FINIALS TO FIT 1<sup>3</sup>/<sub>8</sub>", 2", AND 2<sup>1</sup>/<sub>4</sub>" DIAMETER WOOD POLES, OR 2" AND 2<sup>1</sup>/<sub>2</sub>" TRAVERSING POLES



**Finial 782**  
 2<sup>7</sup>/<sub>8</sub>" Long x 2<sup>3</sup>/<sub>4</sub>" High - 1<sup>5</sup>/<sub>8</sub>" at Base  
 Shown on 2<sup>1</sup>/<sub>4</sub>" Fluted Pole  
 in Walnut (WC 106)



**Finial 781**  
 2<sup>1</sup>/<sub>8</sub>" Long x 2<sup>3</sup>/<sub>8</sub>" High - 1<sup>5</sup>/<sub>8</sub>" at Base  
 Shown on 2" Smooth Pole  
 in Naturelle (03)

# Bohemia on Wood Collection

## Decorative Hand Crafted Faceted Crystal-Glass Finials\*

Available in Iron Art™ Finishes, Wood Art™ Finishes, or Your Own Custom Finish. Also For Use as Tiebacks.  
 FINIALS TO FIT 1 3/8", 2", AND 2 1/4" DIAMETER WOOD POLES, OR 2" AND 2 1/2" TRAVERSING POLES

One of the hallmarks of true faceted crystal-glass is that it shows changes and variations in color when viewed from different angles.



**Finial 770**

3 5/8" Long x 2 1/2" High - 2 1/2" at Base  
 Shown on 1 3/8" Smooth Pole in Old Black (01)



**Finial 764**

3 3/8" Long x 2 1/2" High - 1 5/8" at Base  
 Shown on 2" Smooth Pole  
 in Bronze Vecchio (15)



**773**

2 3/4" Long x 2 3/8" High - 1 5/8" at Base  
 Shown on 2 1/4" Smooth Pole  
 in Rich Gold (07)



**771**

2 3/8" Long x 2 1/4" High - 1 5/8" at Base  
 Shown on 2" Smooth Pole  
 in Naturelle (03)



**772**

2 3/4" Long x 2 3/8" High - 1 3/4" at Base  
 Shown on 2" Fluted Pole  
 in Antique Gold (14)



**776**

2 3/8" Long x 3 1/8" High - 2" at Base  
 Shown on 2" Smooth Pole  
 in Burnt Gold (25)



**777**

3" Long x 2 3/4" High - 2" at Base  
 Shown on 2" Smooth Pole  
 in Naturelle (03)

# *Bohemia on Wood Collection*

## *Decorative Hand Crafted Faceted Crystal-Glass Finials\**

Available in Iron Art™ Finishes, Wood Art™ Finishes, or Your Own Custom Finish. Also For Use as Tiebacks.  
 FINIALS TO FIT 1 3/8", 2", AND 2 1/4" DIAMETER WOOD POLES, OR 2" AND 2 1/2" TRAVERSING POLES



**787**  
 3 1/2" Long x 2" High - 2" at Base  
 Shown on 2" Smooth Pole  
 in Bronze Vecchio (15)



**788**  
 3 1/2" Long x 2" High - 2" at Base  
 Shown on 1 3/8" Smooth Pole  
 in Mahogany (WC 103)



**775**  
 2 3/4" Long x 2 1/2" High - 1 1/2" at Base  
 Shown on 2" Smooth Pole  
 in Rusty (04)



**779**  
 1 1/2" H 3 1/8" High - 1 3/8" at Base  
 Shown on 2" Smooth Pole  
 in Burnt Gold (25)



**774**  
 2" Long x 2 3/4" High - 1 1/2" at Base  
 Shown on 2" Smooth Pole  
 in Burnt Gold (25)



**Finial 763**  
 1 1/8" Long x 3 1/4" High - 3 1/4" at Base  
 Shown on 1 3/8" Smooth Pole  
 in Antique Bronze (02)



**791**  
 3 5/8" Long x 3 5/8" High - 2" at Base  
 Shown on 2" Smooth Pole  
 in Soft Pewter (13)



**792**  
 3 3/4" Long x 3 1/4" High - 2" at Base  
 Shown on 2 1/4" Fluted Pole  
 in Walnut (WC 106)

# Designers' Choice Traversing Rods

## WOOD TRAVERSING OPTIONS

Automatically includes heavy duty track at no extra charge. Finials, rings, and batons sold separately. Glides are available in white, black, antique bronze or gold. • All end pulleys are available only in white.

### FASCIA OPTIONS

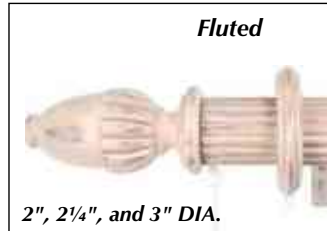
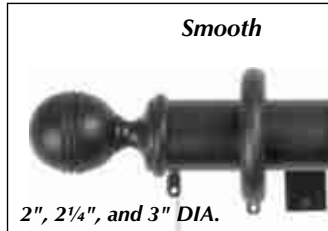

### TRACK SYSTEMS



### RING OPTIONS



### ADDITIONAL INFORMATION

### SAMPLE SINGLE CONFIGURATIONS

Available in 2", 2 1/4", and 3" diameters.



**Shown:**  
**Finial:** 5025  
**Rod:** 2 1/4" Round Traversing Rod  
**Ring:** WT5047TR - Smooth Ring  
**Set Finish:** Walnut  
**Track Finish:** Black  
**Draw Opening:** Center Open



**Shown:**  
**Finial:** 5024  
**Rod:** 2 1/4" Fluted Traversing Rod  
**Ring:** WT5049TR - Fluted Ring  
**Set Finish:** White Distress  
**Track Finish:** White  
**Draw Opening:** Left Stack



**Shown:**  
**Finial:** 5032  
**Rod:** 3" Rope Traversing Rod  
**Set Finish:** Natural  
**Track Finish:** White  
**Draw Opening:** Left Stack





# Designers' Choice Traversing Rods

## SAMPLE DOUBLE CONFIGURATIONS

Available: Front Rod in 2", 2 1/4", and 3" diameters. Back Rod in 1 3/8" diameter only.



Available traversing sets without rings



**Shown:**  
**Finial:** 5052  
**Front Rod:** 3" Smooth Traversing Rod  
**Back Rod:** Track Only  
**Ring:** WT5047TR - Smooth Ring  
**Set Finish:** Mahogany  
**Track Finish:** Black  
**Draw Opening:** Right Stack



Set: WTRN-D

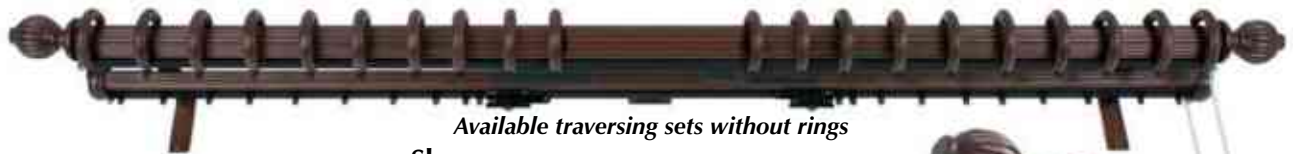

Available traversing sets without rings



**Shown:**  
**Finial:** 5020  
**Front Rod:** 2 1/4" Fluted Traversing Rod  
**Back Rod:** 1 3/8" Fluted Traversing Rod  
**Ring:** WT5049TR - Fluted Ring  
**Set Finish:** Light Cherry  
**Track Finish:** Black  
**Draw Opening:** Center Open



Set: WTFL-D



Available traversing sets without rings, Rope Rod Discontinued



**Shown:**  
**Front Rod:** 3" Rope Traversing Rod with Miter Return\*\*  
**Back Rod:** Track Only  
**Ring:** WT5047TR - Smooth Ring  
**Set Finish:** Sun Oak  
**Track Finish:** White  
**Draw Opening:** Center Open



Set: WTRP-D

\*\*Miter Return at additional charge. Refer to product #WT307MR in Price List.

Automatically includes heavy duty track at no extra charge. Finials, rings, and batons sold separately. Glides are available in white, black, antique bronze or gold. • All end pulleys are available only in white. See page 49 for manual traversing accessories.

See pages 52-57 for traversing systems with Somfy Motorization.

# Wood Craft Collection

## Hand-Carved Finials

Available in Iron Art™ Finishes, Wood Art™ Finishes, or Your Own Custom Finish. Available While Supplies Last.  
FINIALS TO FIT 1 3/8" AND 2" DIAMETER WOOD POLES



**5060 CHINOISE**  
L6 1/2" H4"  
Shown in New Nickel (12)



**5061 SCALLOP**  
L5 1/2" H5 1/4"  
Shown in Burnt Silver (17)



**5062 HALLARD**  
L6 1/2" H3 3/4"  
Shown in Sage Gold (24)



**5063 HAMPTON**  
L6" H2 1/2"  
Shown in Natural (WC 102)



**5064 TOWER**  
L6" H3"  
Shown in Antique White (20)



**5065 BALI**  
L5 1/2" H4"  
Shown in Natural (WC 102)



**5066 DAFFODIL**  
L5 1/2" H3 3/4"  
Shown in Dusk Black (WC 105)



**5067 LILIUM**  
L6" H5"  
Shown in Dusk Black (WC 105)

### FINIALS TO FIT 2" AND 2 1/4" DIAMETER WOOD POLES



**5080 DAHLIA**  
L6 1/4" H6"  
Shown in Antique Bronze (02)



**5081 SEPHORA**  
L6 1/4" H7"  
Shown in High Gloss Dusk Black (WC 105)



**5082 DECO**  
L6 3/4" H7"  
Shown in High Gloss Dusk Black (WC 105)



**5083 IRIS**  
L6 3/4" H4 1/2"  
Shown in Aged Pewter (WC 108)



**5084 STRATA**  
L7" H3 3/4"  
Shown in Aged Pewter (WC 108)



**5085 IMPERIAL**  
L7" H4"  
Shown in Light Cherry (WC 101)



**5086 TIFFANY**  
L5" H4"  
Shown in Imitation Gold Leaf (WC 109)



**5088 REGENCY**  
L6 3/4" H4"  
Shown in Mahogany (WC 103)

# Wood Craft Collection

## Hand-Carved Swag Holders, Brackets, Batons

Tiebacks available as "U" Shape Bend or with Post Projection.  
Available in Iron Art™ Finishes, Wood Art™ Finishes, or Your Own Custom Finish. Available While Supplies Last.



**5096 BALI TIEBACK**  
L4 5/8" DIA  
Shown in Antique Copper (10)



**5097 MING TIEBACK**  
L4 1/2" DIA  
Shown in Light Brown (09)



**5098 TIFFANY TIEBACK**  
L4 1/2" DIA  
Shown in Soft Pewter (13)



**5099 IRIS ACCENT TIEBACK**  
L4 1/2" DIA  
Shown in Brown (19)



**5071 BATON**  
L38"  
5/8" DIA

## Wood Poles & Accessories

Poles and accessories available with 1 3/8", 2", 2 1/4", and 3" diameters (unless mentioned otherwise). Available While Supplies Last.

SMOOTH



FLUTED



AMERICAN STYLE  
WOOD BRACKETS



5045S P4"



5045E P7"

EUROPEAN STYLE  
WOOD BRACKETS



5046S P4"



5046E P7"

5047 SMOOTH RING  
1/2" Thick for 1 3/8", 2", and 2 1/4" Poles  
Not Available for 3" Poles

5048 SMOOTH RING  
7/8" Thick for 3" Poles Only



5049 FLUTED RING  
3/4" Thick



5051 STANDARD SOCKET PAIR  
Shown for 1 3/8"  
Not Available for 3" Poles



5050 SWIVEL MOVABLE ELBOW  
Shown for 1 3/8"  
Not Available for 3" Poles

5056 METAL CONNECTOR FOR WOOD POLES



5052 END CAP



1090 WOOD POST TIEBACK  
2" Diameter in Smooth or Fluted  
2 1/2", 4", 6", or Custom Projections



1087 "U" SHAPE BEND  
Projection 3 1/2"



5053 BATON  
L38"  
1/2" DIA

# Rosina Collection

## Decorative Resin Finials

Available in Iron Art™ Finishes, Wood Art™ Finishes, or Your Own Custom Finish. Available While Supplies Last.

### FINIALS TO FIT 1 3/8" DIAMETER WOOD POLES



**6003**  
L5 1/4" H4"  
Shown in Autumn (05)



**6004**  
L1 1/4" H2 3/4"  
Shown in Rich Gold (07)



**6010**  
L2" H3"  
Shown in Rich Gold (07)



**6022**  
L3 3/4" H2"  
Shown in Antique White (20)

### FINIALS TO FIT 2" AND 2 1/4" DIAMETER WOOD POLES



**6002**  
L4 1/4" H3"  
Shown in Bronze Patina (26)



**6006**  
L8" H4 1/2"  
Shown in Sage Gold (24)



**6007**  
L6" H4"  
Shown in Mahogany (WC 103)



**6009**  
L6" H3 1/4"  
Shown in Autumn (05)

# Rosina Collection

## Decorative Resin Finials

Available in Iron Art™ Finishes, Wood Art™ Finishes, or Your Own Custom Finish. Available While Supplies Last.

### FINIALS TO FIT 2" AND 2¼" DIAMETER WOOD POLES



6011

L6" H3"

Shown in Bronze Vecchio (15)



6013

L6" H3¼"

Shown in Mahogany (WC 103)



6017

L5" H3"

Shown in Naturelle (03)



6019

L6" H3"

Shown in Golden Oak (29)



6020

L4¾" H2¾"

Shown in Golden Oak (29)

# New York Wood Collection

## Exclusive Hand-Painted Wood Finials

Wood Art™ by Orion proudly presents this collection of Wood Finials that fit 1 3/8", 2", 2 1/4" & 3" Wood Poles.

Each item is finished by our artisans to create an impeccable look.

Available in Iron Art™ finishes, Wood Art™ finishes, or your own custom finish. Available While Supplies Last.

### FINIALS TO FIT 1 3/8" DIAMETER WOOD POLES



**5040 ACORN**  
L4 1/4" H2"  
Shown in High Gloss  
Golden Teak (WC 110)



**5041 FLUTED**  
L3 1/4" H2"  
Shown in White Wash (WC 104)



**5042 BALL**  
L3" H2"  
Shown in White Wash (WC 104)



**5043 DIAMOND**  
L3 1/2" H2 1/4"  
Shown in High Gloss  
Golden Teak (WC 110)

### FINIALS TO FIT 2", 2 1/4", AND 3" DIAMETER WOOD POLES



**ORNATE FLUTE**  
5020 L4 1/2" H3" for 2" & 2 1/4" Wood Poles  
5030 L5" H3 1/2" for 3" Wood Poles  
5020 Shown in Light Cherry (WC 101)



**SAXON**  
5021 L6 1/2" H2 3/4" for 2" & 2 1/4" Wood Poles  
5031 L6 1/4" H3 1/2" for 3" Wood Poles  
5031 Shown in White Distress (WC 107)



**CUP**  
5022 L5" H2 1/2" for 2" & 2 1/4" Wood Poles  
5032 L5 1/2" H3 1/2" for 3" Wood Poles  
5032 Shown in White Distress (WC 107)



**WINDSOR**  
5023 L5 1/2" H3" for 2" & 2 1/4" Wood Poles  
5033 L6 1/2" H3 3/4" for 3" Wood Poles  
5023 Shown in Mahogany (WC 103)



**DECORATIVE ACORN**  
5024 L5 1/2" H3" for 2" & 2 1/4" Wood Poles  
5034 L5 1/2" H3 1/2" for 3" Wood Poles  
5034 Shown in High Gloss Walnut (WC 106)



**DESIGNER BALL**  
5025 L4 1/4" H3" for 2" & 2 1/4" Wood Poles  
5035 L5 1/2" H3 1/2" for 3" Wood Poles  
5025 Shown in Sun Oak (WC 111)



**YORK**  
5026 L6" H3" for 2" & 2 1/4" Wood Poles  
5036 L6 3/4" H3 1/2" for 3" Wood Poles  
5036 Shown in High Gloss Walnut (WC 106)



**TUDOR**  
5027 L6" H3" for 2" & 2 1/4" Wood Poles  
5037 L6 3/4" H3 1/2" for 3" Wood Poles  
5027 Shown in Sun Oak (WC 111)



**WOOD BALL**  
5028 L5" H3 1/2" for 2" & 2 1/4" Wood Poles  
5038 L7" H4 1/2" for 3" Wood Poles  
5028 Shown in Walnut (WC 106)

# Promotional Items



**8000 - IRON ART PRODUCT WALL DISPLAY - SET ONE**  
L32" H48"  
(TUSCANY DISCONTINUED)



**8001 - IRON ART PRODUCT WALL DISPLAY - SET TWO**  
L32" H48"



**8002 - XPRESS YOURWAY QUICK SHIP WALL DISPLAY**  
L32" H48"



**8003 DESIGNER FINIAL SET**  
6 Finial with Rod Samples



**8017 - DESIGNER ROD SIZE SET**  
9 rod samples with base & top



**8006 - TROPICAL (BAMBOO) FINISH SELECTOR SET**  
All 6 finishes on a metal ring



**8011 - DESIGNER SAMPLE KIT**  
L20" W15" H5" Weight 11 lbs.

**8018 - DESIGNER RING SIZE SET**  
10 ring diameters on hinged snap ring



**8016 - SINGLE SQUARE COLOR SELECTOR CHIP**



**8004 - IRON ART™ FINISH SELECT SET**  
All 35 finishes in plastic binder sleeves

**8005 - WOOD ART™ FINISH SELECT SET**  
All 11 finishes in a plastic binder sleeve

**8014 - ITALIAN FINISH SELECTOR SET**  
All 13 finishes in a plastic binder sleeve

**8008 - COLOR SELECTOR SETS IN BINDER**  
Iron Art™, Wood Art™, and Italian Collection Finish Selectors

**8009 - CATALOG & PRICE LIST SET**

**8015 - Binder Plus Catalog and Price List**

Also available in Semi or High Gloss Finishes. Please add 20% upcharge.

# Iron Art Finishes

## IRON ART FINISHES: A



09 Light Brown



14 Black



19 Brown

## IRON ART FINISHES: B



01 Old Black



02 Antique Bronze



03 Naturelle



04 Rusty



06 Antique Gold



07 Rich Gold



10 Antique Copper



12 New Nickel



13 Soft Pewter



15 Bronze Vecchio



17 Burnt Silver



20 Antique White



32 Ivory



33 Pure White



34 Oil Rubbed Bronze



35 Metal Ore

Please note the finishes presented above are lithographic reproductions of Orion's actual finishes, and as such may not accurately reflect the true depth and tone of our finishes. Please always refer to actual Orion finish samples before ordering our products.



# Iron Art Finishes

Also available in Semi or High Gloss Finishes. Please add 20% upcharge.

## IRON ART FINISHES: C



11 Versace



16 Gold Antique White



18 Renaissance Silver



24 Sage Gold



25 Burnt Gold



26 Bronze Patina



27 Cherry Gold



28 Vecchio Patina



29 Golden Oak

## IRON ART FINISHES: D



05 Autumn



08 Imposter



21 Crackle



22 Antique Crackle



23 Mocha Mix



30 Warm Cherry



31 Sugar Maple

Please note the finishes presented above are lithographic reproductions of Orion's actual finishes, and as such may not accurately reflect the true depth and tone of our finishes. Please always refer to actual Orion finish samples before ordering our products.

*... always leaves a lasting impression!*

# Wood Art Finishes

## WOOD ART HAND STAINS : E



WC 101 Light Cherry



WC 102 Natural



WC 103 Mahogany



WC 104 White Wash

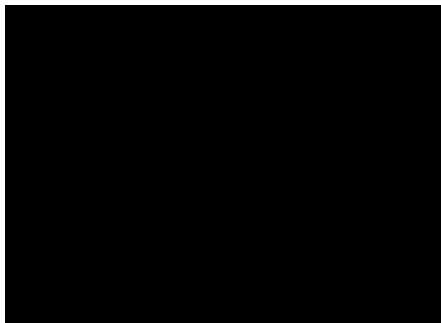

WC 105 Dusk Black



WC 106 Walnut

## WOOD ART HAND STAINS : F



WC 107 White Distress



WC 108 Aged Pewter



WC 109 Imitation Gold Leaf



WC 110 Golden Teak



WC 111 Sun Oak



Please note the finishes presented above are lithographic reproductions of Orion's actual finishes, and as such may not accurately reflect the true depth and tone of our finishes. Please always refer to actual Orion finish samples before ordering our products.

# Measurement Guidelines

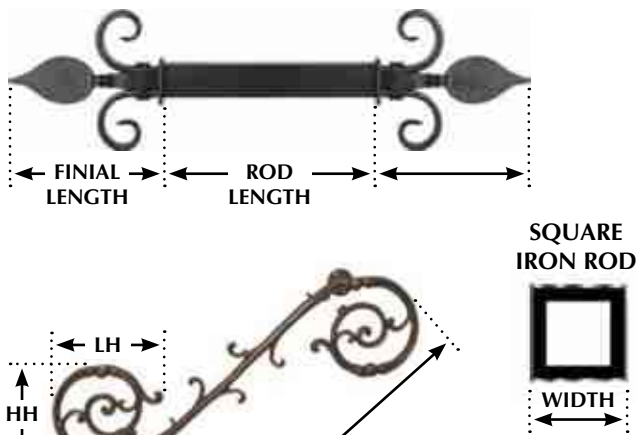
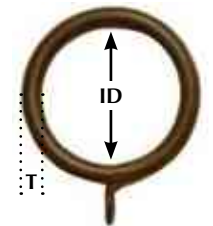
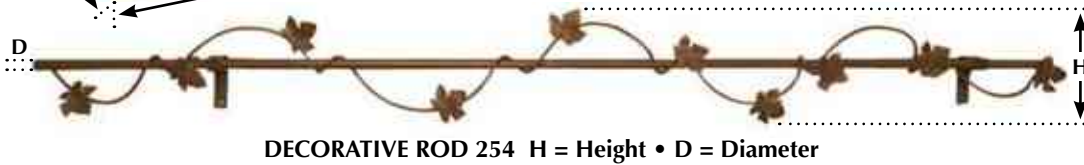
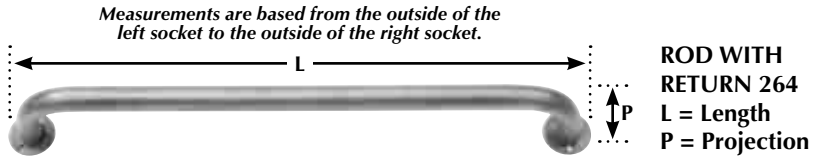
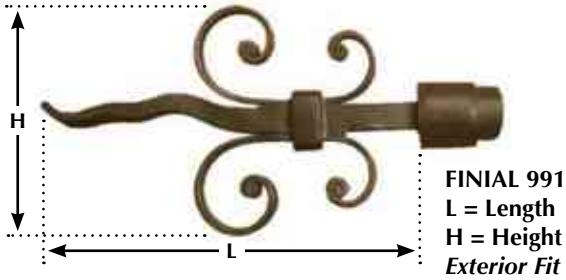
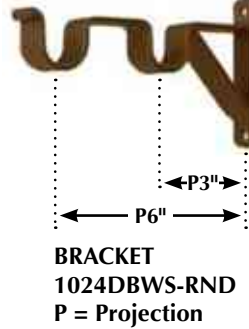
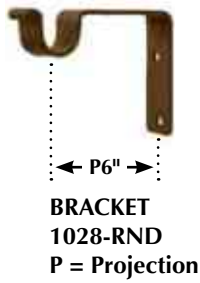
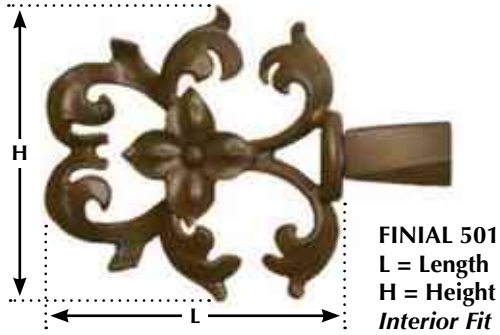

## IRON ROD AND WOOD POLE DIAMETERS

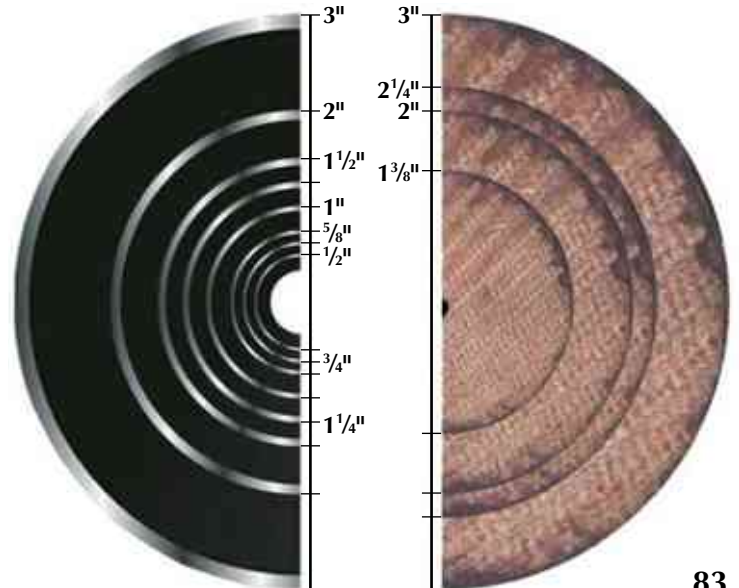

# ORION

ORNAMENTAL IRON, INC.



Feb 2022 Reprint

