

RETAIL PRICE GUIDE

THE WORLD BEHIND YOUR DRAPERIES

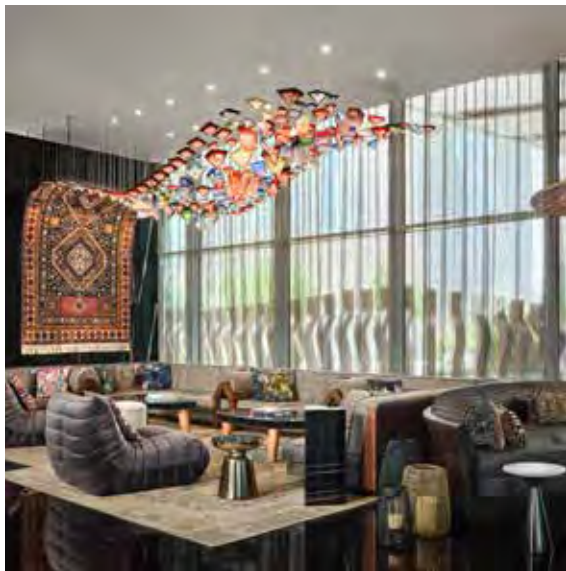

THE WORLD BEHIND YOUR DRAPERIES



ON THE COVER AND ABOVE: The W Dubai Mina Seyahi is a luxury gateway for expats and locals seeking new discoveries and is always buzzing with energy, opportunity & great vibes. The hotel has iconic glass architecture towering over the city below, offering unobstructed views of the Arabian Gulf from each of the 318 elegantly designed guest rooms & suites. Featured in these rooms are Forest CS® and KS® tracks. Tracks have also been cleverly used as room dividers and to separate the closets. In the lobby and restaurants, you will find Forest motorized tracks paired with the Forest Shuttle® drapery motor. Guest rooms design by BLINK.

TABLE OF CONTENTS

TRACK SYSTEMS

CS Heavy Duty Track System	3-6
CM Heavy Duty Ceiling Mount Track System	3-6
CCS Heavy Duty Corded Track System	7-8
RTS Recessed Track System	9-10
KS Light-Medium Duty Klick System	11-12
DS Design System	11-12
DSXL Design System XL	13-14
DSXL LED Design System XL with LED Lighting	13-14

BENDS/CURVES, BATONS & WORKROOM

BEND/CURVES	17-18
BATONS	19
WORKROOM Components	20
FES Forest Easyflex System	20

ROLLERS & ROMANS

APOLLO Basic Roller Shades	23-24
MERCURY Decorative Roller Shades	25-30
ATLANTIS Motorized Heavy Duty Roller Shades	31-32
FABRIC for Roller Shades - Quick Ship	33-34
RBS Roman Blind System - Cord Control	35-36
RBS Roman Blind System - Motorized	37-38
RBS XL Roman Blind System XL	39-40
BCS Motorized Blind Contract System	41-42
ENDEAVOR Make Your Own Romans	43-44

DECORATIVE METAL HARDWARE

TAVIRA OUTDOOR Pole Sets	47
TAVIRA OUTDOOR Traversing Sets	48
FARO SQUARE Pole Sets	49-50
GLASGOW ACRYLIC Pole Sets	51-52
LISBON 1 3/16" Pole Sets	53-54
AVEIRO 1 3/16" Pole Sets	55-56
PORTO 3/4" Wrought Iron Pole Sets	57-58

PORTO 1 3/16" Wrought Iron Pole Sets	59-60
DRESDEN 1 1/8" Pole Sets	61-62
DRESDEN 1 1/8" Traversing	63-64
DRESDEN CORDED 1 1/8" Traversing	65-66
DEVENTER DECO 1 1/8" Pole Sets	67-68
DEVENTER CRS 1 1/8" Traversing	69-70
FRANKFURT SQUARE RAIL Traversing	71-72
STUTTGART RECTANGLE RAIL Traversing	73-74
HANOVER CONTEMPORARY Traversing	75-76

DECORATIVE WOOD HARDWARE

SEVILLE 1 3/8" Pole Sets	79-80
VALENCIA 1 3/4" Pole Sets	81-82
CORDOBA 2" Pole Sets	83-84
CORDOBA 2" Traversing	85-86
LONDON 1 3/8" & 1 3/4" Pole Sets	87-88
LONDON 1 3/8" & 1 3/4" Traversing	89-90

DRAPERY MOTORIZATION

SHUTTLE Motor Specifications	93-94
CONTROLS Roadmap	95-96
FMS TRACK Motorized	97-98
RMS RECESSED Motorized	99-100
DSXL LED Motorized Design System + LED Lighting	101-102
HANOVER CONTEMPORARY Motorized	103-104
DRESDEN 1 1/8" Motorized	105-108
DEVENTER MRS 1 1/8" Motorized	109-110
CORDOBA WOOD Motorized	111-112
LONDON WOOD Motorized	113-114

APPENDIX

Terms and Conditions	117
Ordering Instructions	118
Returns, Warranty & Care	118
Ripplefold Carrier Counts	119-120
Child Safety	121
Product Support & Sales Tools	121-122



TRACK SYSTEMS

Forest track systems are installed in more than 100 countries worldwide, in both residential and commercial projects. Features include a 10-year warranty, powder coated finish, easy installation, and ultra-quiet operation with our patented lubrication process.

THE
WORLD
BEHIND
YOUR
DRAPERIES

CS®

CM

CCS®

RTS

KS®

DS®

DSXL®
DSXL® LED



MOTORIZED
P. 99-100



MOTORIZED
P. 101-102



Scan for more information on FOREST Track Systems

CS[®] CONTRACT SYSTEM CM CEILING MOUNT TRACK

- Heavy duty aluminum extrusion, powder coated, and lubricated with a patented process.
- Maximum weight is 6 lbs/ft.
- CS track can be bent and curved. An exact size template is required. See pages 17-18 for more information.
- Hand or baton draw, one or two way.
- Stackback: Ripplefold - 6" per width, pinchpleat - 7" per width, cubicle - 5" per width.

ASSEMBLED PRICING

Includes track, masters, pinchpleat or ripplefold carriers, brackets, and 36" white fiberglass baton (See all batons page 19). Freight is additional.

	first 4 feet	ea. add'l foot
CS White	\$159.27	\$15.67
CS Black, Brown, Grey	\$175.19	\$17.23
CM White Only	\$138.53	\$11.49

BATON OPTIONS

White fiberglass batons are available in 36", 48", 60", and 72" lengths. See all baton options, including the finishes below, on page 19.



25 White



59 Black



65 Brown



90 Grey



25 White



25 White



59 Black











81 Bronze

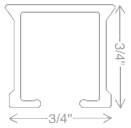
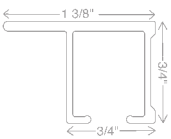
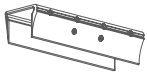















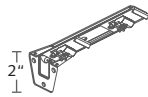

90 Grey

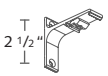
TRACKS SYSTEMS

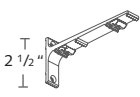
CS | CM | CCS | RTS | KS | DS | DSXL | DSXL LED

CS	CM	COMPONENT	PRICE
●		 <p>CS Contract System Track 51012-25 white 12' 51014-25 white 14' 51016-25 white 16' 51020-25 white 20'</p> <p>51016-59 black 16' 51020-59 black 20' 51016-65 brown 16' 51016-90 grey 16'</p>	<p>\$4.68/ft. 20 tracks /bundle</p> <p>\$5.15/ft. 20 tracks /bundle</p>
●		 <p>CM Ceiling Mount Track 51212-25 white 12' 51214-25 white 14' 51216-25 white 16' Holes every 16"</p>	<p>\$5.78/ft. 20 tracks/ bundle</p>
●		 <p>3906-25 59 black, 65 brown, 90 grey +10% Track Connector</p>	<p>\$20.37 ea. 10/box</p>
●		 <p>55090-25 90° Pre-Bent CS Corners 24" x 24"</p>	<p>\$267.38/box 12/box</p>
●	●	 <p>52304-25 59 black, 65 brown, 90 grey +10% End Cap - Short reduces light gap</p>	<p>\$3.92 ea.  \$3.26 ea. /box of 400</p>
●	●	 <p>52301-25 59 black, 65 brown, 90 grey +10% End Cap w/ Economy Slide Add 2004-25 w/ Ripplefold</p>	<p>\$1.57 ea.  \$1.30 ea. /box of 400</p>
●	●	 <p>52302-25 Right Return 52303-25 Left Return End Cap w/ Return Plate, Snap for pinch pleat or Ripplefold</p>	<p>\$2.72 ea.  \$2.27 ea. /box of 100</p>
●		 <p>9100-00 Channel Protector</p>	<p>\$17.72 ea.</p>
●		 <p>3001-25 59 black 90 grey +10% Regular Duty Ceiling Bracket</p>	<p>\$1.56 ea.  \$1.28 ea. /box of 100</p>

CS	CM	COMPONENT	PRICE
●		 <p>3901-25 59 black, 90 grey 90 +10% Ceiling Splice/Bracket</p>	<p>\$2.65 ea.  \$2.20 ea. /box of 50</p>
●		 <p>3003-25 59 black, 65 brown, 90 grey +10% Heavy Duty Ceiling Bracket w/ Smart Klick</p>	<p>\$2.65 ea.  \$2.19 ea. /box of 100</p>
●		 <p>30031-25 59 black, 65 brown, 90 grey +10% Ceiling Bracket Cover use with 3003-XX</p>	<p>\$1.10 ea.  \$0.92 ea. /box of 100</p>
●		 <p>53202-25 59 black, 65 brown, 90 grey +10% 3" Smart Klick Wall Bracket w/ wide base, adjusts 3-4.5"</p>	<p>\$6.34 ea.  \$5.28 ea. /box of 100</p>
●		 <p>53206-25 59 black, 65 brown, 90 grey +10% 6" Smart Klick Double Wall Bracket w/ wide base adjusts 2.5"-4" & 6"-7.5"</p>	<p>\$11.16 ea.  \$9.30 ea. /box of 50</p>
●		 <p>3280-25 59 black, 65 brown, 90 grey +10% 3" Wall Bracket, heavy duty projection 2 1/2"</p>	<p>\$14.58 ea.  \$12.15 ea. /box of 20</p>
●		 <p>3281-25 59 black, 65 brown, 90 grey +10% 6" Double Wall Bracket, heavy duty projection 1 1/2", 5 1/2"</p>	<p>\$20.90 ea.  \$17.41 ea. /box of 15</p>
●		 <p>32801-25 59 black, 90 grey +10% Wall Bracket Cover use with 3280 & 3281</p>	<p>\$3.76 ea.  \$3.13 ea. /box of 50</p>

 BREAK PACK PRICING  - Prices with this designation indicate a 20% up charge for broken pack quantities.

● Standard item in assembled sets.

TRACKS SYSTEMS

CS | CM | CCS | RTS | KS | DS | DSXL | DSXL LED

TRACKS CS CM











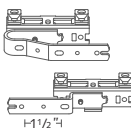





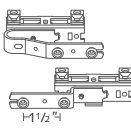













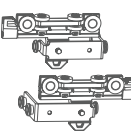



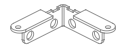

CS	CM	COMPONENT	PRICE	CS	CM	COMPONENT	PRICE
●	●	 <p>Wheeled Connected Snap Carrier with pendant, in plastic sleeve 2107-25, 59 black 60% fullness, 2 5/8" OC 2106-25, 59 black 65 brown, 90 grey 80% fullness, 2 3/8" OC 2105-25, 59 black 100% fullness, 2 1/8" OC 2108-25, 59 black 120% fullness, 1 7/8" OC</p>	\$1.83 ea. \$1.52 ea. /roll of 500 Colors other than white +10%	●	●	 <p>52108-25 Stop Carrier prevents slide back</p>	\$2.65 ea. \$2.20 ea. /box of 100
●	●	 <p>Wheeled Connected Snap Carrier with pendant, on plastic strip 2207-25 60% fullness, 2 5/8" OC 2206-25, 59, 65, 90 80% fullness, 2 3/8" OC 2205-25 100% fullness, 2 1/8" OC 2208-25 120% fullness, 1 7/8" OC</p>	\$2.37 ea. \$1.98 ea. /box of 500 Colors other than white +10%	●	●	 <p>52100-25 59 black, 65 brown, 90 grey + 10% Ball Bearing Carrier w/ Stainless Hook slim line - use w/ grommets</p>	\$2.24 ea. \$1.86 ea. /box of 1000 Colors other than white +10%
●	●	 <p>2007-25 59 black + 10% Pendant for Snap Tape Carrier</p>	\$0.26 ea. \$0.22 ea. /bag of 500	●	●	 <p>52005-25 Button Slide Carrier</p>	\$0.28 ea. \$0.24 ea. /box of 1000
●	●	 <p>2008-25 59 black, 65 brown, 90 grey + 10% Short Pendant for Snap Tape Carrier</p>	\$0.24 ea. \$0.21 ea. /bag of 500	●	●	 <p>52105-25 Button Slide Carrier w/ Hook</p>	\$0.87 ea. \$0.73 ea. /box of 500
●	●	 <p>2004-25 59 black, 65 brown, 90 grey + 10% Snap Carrier for accordiafold</p>	\$0.67 ea. \$0.57 ea. /bag of 500	●	●	 <p>52502-25 Overlap R 52504-25 Underlap L 59 black + 10% Standard Multi-Functional Master Use stiffener w/ exposed baton or hooks w/ hidden baton</p>	\$8.80 ea. \$7.34 ea. /box of 100
●	●	 <p>52002-25 59 black, 65 brown, 90 grey + 10% Slim Line Ball Bearing Carrier</p>	\$0.82 ea. \$0.67 ea. /box of 1000	●	●	 <p>52502-25A Overlap R 52504-25A Underlap L 59A black + 10% Standard Multi-Functional Master w/ snaps and baton adaptor</p>	\$10.66 ea. \$8.89 ea. /box of 100
●	●	 <p>52008-25 59 black, 65 brown + 10% Slim Line Klick Carrier draperies hang to conceal track</p>	\$1.31 ea. \$1.08 ea. /box of 250	●	●	 <p>52502-25B Overlap R 52504-25B Underlap L Standard Multi-Functional w/ baton adaptor for stiffener. Stainless steel for outdoor use.</p>	\$8.80 ea. \$7.34 ea. /box of 50

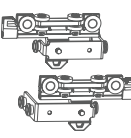
BREAK PACK PRICING - Prices with this designation indicate a 20% up charge for broken pack quantities.

● Standard item in assembled sets.

TRACKS SYSTEMS

CS | CM | CCS | RTS | KS | DS | DSXL | DSXL LED

CS	CM	COMPONENT	PRICE	CS	CM	COMPONENT	PRICE
●	●	 <p>52508-25 Overlap R 52509-25 Underlap L 59 black, 65 brown + 10% Swivel Foot Multi-Functional Master for bends and curves</p>	\$15.51 ea.  \$12.95 ea.  /box of 100	●	●	 <p>52601-25A Overlap R 52603-25A Underlap L Extended Spacing Master w/ snaps and adaptor</p>	\$7.31 ea.  \$5.94 ea.  /box of 100
●	●	 <p>52508-25A Overlap R 52509-25A Underlap L 59 black, 65 brown + 10% Swivel Foot Multi-Functional Master w/ snaps</p>	\$18.39 ea.  \$15.33 ea.  /box of 100	●	●	 <p>2552-25 6" Extension Arm for master Use w/ two one-way draws</p>	\$14.42 ea.  \$12.03 ea.  /box of 50
●	●	 <p>52501-25 Overlap R 52503-25 Underlap L Stiffener Master</p>	\$8.80 ea.  \$7.34 ea.  /box of 50	●	●	 <p>2551-25 Small Extension Arm</p>	\$5.24 ea.  \$4.35 ea.  /box of 50
●	●	 <p>52401-25 Overlap R 52403-25 Underlap L Stiffener Master w/ snaps and adaptor</p>	\$10.79 ea.  \$8.99 ea.  /box of 50	●	●	 <p>2305-25 59 black, 65 brown, 90 grey + 10% Twist On End Stop</p>	\$2.65 ea.  \$2.20 ea.  /box of 100
●	●	 <p>52410-25 Butt R 52409-25 Butt L 59 black + 10% Standard Butt Master w/ snaps and for baton use</p>	\$21.38 ea.  \$17.80 ea.  /box of 50	●	●	 <p>2308-25 Return Plate reversible, 2 1/2" return</p>	\$9.98 ea.  \$8.33 ea.  /box of 100
●	●	 <p>52411-25A Butt R 52412-25A Butt L 59A black, 65A brown, 90A grey + 10% Wheeled Butt Master w/snap adaptor Designed for hidden baton</p>	\$37.74 ea.  \$31.44 ea.  /box of 50	●	●	 <p>52307-90 End Lock</p>	\$1.18 ea.  \$0.98 ea.  /box of 100
●	●			●	●	 <p>54110-25 36" Fiberglass Baton w/ snap</p>	\$9.26 ea.  \$7.72 ea.  /box of 100 See all batons page 19

 BREAK PACK PRICING  - Prices with this designation indicate a 20% up charge for broken pack quantities.

● Standard item in assembled sets.



Scan for more information on the FOREST CCS Contract Cord System

CCS® CONTRACT CORD SYSTEM

- Aluminum extrusion, powder coated and lubricated with a patented process.
- Maximum weight is 50 lbs per system.
- Bendable – CCS Track can be bent and curved. An exact size template is required. See pages 17-18 for more information.
- Cord draw, one or two way.
- Stackback: Ripplefold - 6" per width, pinchpleat - 7" per width, accordiafold - 5" per width.
- All Forest corded products include a child safety tension device and warning label.

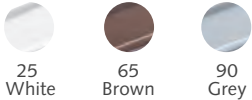







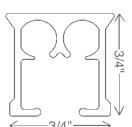

25 White 65 Brown 90 Grey

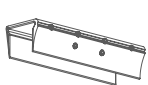
ASSEMBLED PRICING

Includes track, masters, pinchpleat or ripplefold carriers, brackets, cord, tension pulley, child safety device. Freight is additional.

CCS CONTRACT SYSTEM	first 4 feet	ea. add'l foot
White	\$245.41	\$20.93
Brown, Grey	\$269.95	\$23.02

CCS	COMPONENT	PRICE	CCS	COMPONENT	PRICE
•	 <p>CCS Contract Cord Track 20 tracks/bundle 51116-25 white 16' 51116-65 brown 16' 51116-90 grey 16'</p>	<p>\$6.08/ft. \$6.69/ft. \$6.69/ft.</p>	•	 <p>52801-25A Right 52801-25B Left End Pulley w/ Snap 2 1/4" Reversible, for Ripplefold</p>	<p>\$14.70 ea.  \$12.24 ea. /box 25</p>
•	 <p>3906-25 59 black, 65 brown, 90 grey +10% Track Connector</p>	<p>\$20.37 ea. 10/box</p>	•	 <p>52803-25 65 brown, 90 grey +10% Small End Pulley 1 1/2" Reversible, use with Butt Masters and one-way draw</p>	<p>\$13.51 ea.  \$11.26 ea. /box 25</p>
•	 <p>52801-25 65 brown, 90 grey +10% End Pulley, 2 1/4" Reversible Use on right or left</p>	<p>\$13.51 ea.  \$11.26 ea. /box 25</p>	•	 <p>3001-25 59 black, 65 brown, 90 grey +10% Regular Duty Ceiling Bracket</p>	<p>\$1.56 ea.  \$1.28 ea. /box of 100</p>

TRACKS SYSTEMS

CS | CM | **CCS** | RTS | KS | DS | DSXL | DSXL LED

CCS	COMPONENT	PRICE	CCS	COMPONENT	PRICE
●	 <p>3003-25 59 black, 65 brown, 90 grey +10% Heavy Duty Ceiling Bracket w/ Smart Klick</p>	\$2.65 ea.  \$2.19 ea. /box of 100	●	 <p>52008-25 59 black, 65 brown +10% Slim Line Klick Carrier draperies hang to conceal track</p>	\$1.31 ea.  \$1.08 ea. /box of 250
●	 <p>30031-25 59 black, 65 brown, 90 grey +10% Ceiling Bracket Cover use with 3003-XX</p>	\$1.10 ea.  \$0.92 ea. /box of 100	●	 <p>52004-25 Low Profile Ball Bearing</p>	\$1.84 ea.  \$1.51 ea. /box of 1000
●	 <p>53202-25 59 black, 65 brown, 90 grey +10% 3" Smart Klick Wall Bracket w/ wide base, adjusts 3-4.5"</p>	\$6.34 ea.  \$5.28 ea. /box of 100	●	 <p>52508-25 Overlap R 52509-25 Underlap L 59 black, 65 brown +10% Swivel Foot Multi-Functional Master for bends and curves</p>	\$15.51 ea.  \$12.95 ea. /box of 100
●	 <p>53206-25 59 black, 65 brown, 90 grey +10% 6" Smart Klick Double Wall Bracket w/ wide base adjusts 2.5"-4" & 6"-7.5"</p>	\$11.16 ea.  \$9.30 ea. /box of 50	●	 <p>52508-25A Overlap R 52509-25A Underlap L 59 black, 65 brown +10% Swivel Foot Multi-Functional Master w/ snaps</p>	\$18.39 ea.  \$15.33 ea. /box of 100
●	 <p>3280-25 59 black, 65 brown, 90 grey +10% 3" Wall Bracket, heavy duty projection 2 1/2"</p>	\$14.58 ea.  \$12.15 ea. /box of 20	●	 <p>52410-25 Butt R 52409-25 Butt L 59 black + 10% Standard Butt Master w/ snaps for baton use</p>	\$21.38 ea.  \$17.80 ea. /box of 50
●	 <p>3281-25 59 black, 65 brown, 90 grey +10% 6" Double Wall Bracket, heavy duty projection 1 1/2", 5 1/2"</p>	\$20.90 ea.  \$17.41 ea. /box of 15	●	 <p>52510-25 59 black, 65 brown, 90 grey +10% Cord Connector</p>	\$2.86 ea.  \$2.38 ea. /box of 100
●	 <p>32801-25 59 black, 90 grey +10% Wall Bracket Cover use with 3280 & 3281</p>	\$3.76 ea.  \$3.13 ea. /box of 50	●	 <p>9004-25 3.2mm Cord 333.34 yds./roll</p>	\$2.46/yd.  \$820.28/roll
●	 <p>Two Piece Connected Snap Carrier w/ Square Base, in plastic sleeve. Use 1 1/4" snap tape 2114-25, 59 black 60% fullness, 2 5/8" OC 2111-25, 59 black, 65 brown, 90 grey 80% fullness, 2 3/8" OC 2112-25, 59 black 100% fullness, 2 1/8" OC 2115-25, 59 black 120% fullness, 1 7/8" OC</p>	\$1.47 ea.  \$1.23 ea. /roll of 500 Colors other than white +10%	●	 <p>49501-00 Tension Device For child safety</p>	\$10.32 ea.  \$8.59 ea. /box of 250

 BREAK PACK PRICING  - Prices with this designation indicate a 20% up charge for broken pack quantities.

● Standard item in assembled sets.



Scan for more information on the FOREST RTS Recessed Track System



25
White

RTS RECESSED TRACK SYSTEM

- Heavy duty aluminum extrusion, white, powder coated and lubricated with a patented process.
- Maximum weight is 8 lbs/ft.
- Splicing available. Please call sales for more information.
- Hand or baton draw, one or two way.
- Stackback: Ripplefold - 6" per width, pinchpleat - 7" per width, cubicle - 5" per width.



ASSEMBLED PRICING

Includes track, masters, pinchpleat or ripplefold carriers, recess profile, fixing strip, wedge, and 36" white fiberglass baton (See all batons page 19). Freight is additional.

RTS RECESSED TRACK	first 4 feet	ea. add'l foot
White	\$261.96	\$34.33

BATON OPTIONS

White fiberglass batons are available in 36", 48", 60", and 72" lengths. See all baton options, including the finishes below, on page 19.



25
White



59
Black













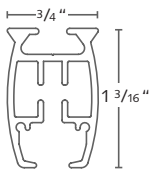

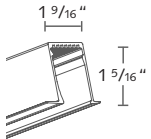

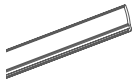
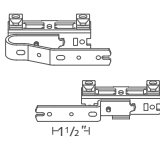

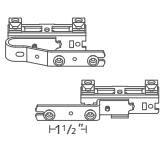

81
Bronze

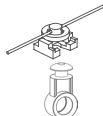

90
Grey

TRACKS SYSTEMS

CS | CM | CCS | **RTS** | KS | DS | DSXL | DSXL LED

RTS	COMPONENT	PRICE	RTS	COMPONENT	PRICE
●	 <p>51623-25 RTS Track white 19' x 10 tracks/bundle bundle = 190'</p>	\$14.86/ft.	●	 <p>52008-25 Slim Line Klick Carrier Allows drapery to hang and conceal track</p>	\$1.31 ea.  \$1.08 ea. /box of 250
●	 <p>51723-25 Recess Profile, 23' Order same length as track</p>	\$19.66/ft.	●	 <p>52009-25 Ball Bearing Carrier</p>	\$1.84 ea.  \$1.51 ea. /box of 250
●	 <p>51724-25 Recess Profile Fixing Strip, 23' Order 6" shorter than track</p>	\$4.13/ft.	●	 <p>52508-25 Overlap R 52509-25 Underlap L Swivel Foot Multi-Functional Master</p>	\$15.51 ea.  \$12.95 ea. /box of 100
●	 <p>53914-25 Recess Profile Wedge Order 1 per track</p>	\$5.80 ea.  \$4.81 ea. /box of 10	●	 <p>52508-25A Overlap R 52509-25A Underlap L Swivel Foot Multi-Functional Master w/ snaps</p>	\$18.39 ea.  \$15.33 ea. /box of 100
●	 <p>3801-25 RTS End Cap</p>	\$7.67 ea.  \$6.39 ea. /box of 200	●	 <p>52410-25 Butt R 52409-25 Butt L Standard Butt Master w/ 3 snaps for baton use</p>	\$21.38 ea.  \$17.80 ea. /box of 50
●	 <p>Two Piece Connected Snap Carrier w/ Square Base, in plastic sleeve. Use 1 1/4" snap tape 2114-25, 59 black 60% fullness, 2 5/8" OC 2111-25, 65 brown, 90 grey 80% fullness, 2 3/8" OC 2112-25, 59 black 100% fullness, 2 1/8" OC 2115-25, 59 black 120% fullness, 1 7/8" OC</p>	\$1.47 ea.  \$1.23 ea. /roll of 500 Colors other than white +10%	●	 <p>54110-25 36" Fiberglass Baton w/ snap</p>	\$9.26 ea.  \$7.72 ea. /box of 100 See all batons page 19

 **BREAK PACK PRICING**  - Prices with this designation indicate a 20% up charge for broken pack quantities.

● Standard item in assembled sets.

TRACKS RECESSED



Scan for more information on the
FOREST Track Systems

KS® KLICK SYSTEM DS® DESIGN SYSTEM

- Aluminum extrusion, powder coated and lubricated with a patented process.
- Maximum weight is 3 lbs/ft.
- Bendable – KS & DS tracks can be bent and curved. An exact size template is required. See pages 17-18 for more information.
- Hand or baton draw, one or two way.
- Stackback per width: ripplefold - 6", pinchpleat - 7", cubicle - 5", accordiafold - 5".

ASSEMBLED PRICING

Includes track, masters, pinchpleat or ripplefold carriers, brackets, and 36" white fiberglass baton (See all batons page 19). Freight is additional.

	first 4 feet	ea. add'l foot
KS Track White	\$137.31	\$15.95
KS Track Black, Brown, Grey	\$151.04	\$17.55
DS Track White	\$191.12	\$18.80
DS Track Graphite	\$210.23	\$20.68

BATON OPTIONS



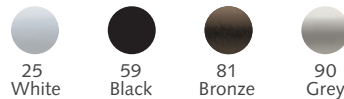
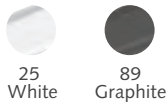



White fiberglass batons are available in 36", 48", 60", and 72" lengths. See all baton options, including the finishes below, on page 19.





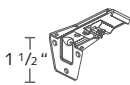
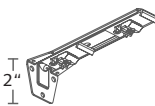
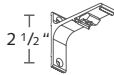
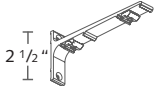



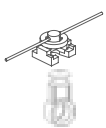



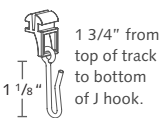

KS	DS	COMPONENT	PRICE	KS	DS	COMPONENT	PRICE
•		<p>KS Klick System Track 1013-25 white 13' 1" 1016-25 white 16' 4" 1019-25 white 19' 8"</p>	\$4.82/ft. 20 tracks /bundle	•		<p>2309-255 59S black, 90S grey KS End Cap Short reduces light gap</p>	\$1.50 ea. \$1.24 ea. /box 100 Colors + 10%
		<p>1016-59 black 16' 4" 1016-65 brown 16' 4" 1016-90 grey 16' 4"</p>	\$5.22/ft. 20 tracks /bundle		•	<p>2310-25 89 graphite DS End Cap w/ screw</p>	\$2.53 ea. \$2.12 ea. /box 10 Colors + 10%
•		<p>DS Design System Track 1116-25 white 16' 4" 89 graphite +10%</p>	\$7.45/ft. 20 tracks /bundle	•	•	<p>9100-00 Channel Protector</p>	\$17.72 ea.
•	•	<p>3905-25 59 black, 65 brown, 90 grey +10% Track Connector, key 3904-00</p>	\$12.05 ea. \$10.05 ea. /box 50	•	•	<p>3001-25 59 black, 65 brown, 90 grey Regular Duty Ceiling Bracket</p>	\$1.56 ea. \$1.28 ea. /box 100 Colors +10%
•		<p>2309-25 59 black, 65 brown, 90 grey +10% KS End Cap Multifunctional</p>	\$1.50 ea. \$1.24 ea. /box 100	•	•	<p>3901-25 59 black, 65 brown, 90 grey Ceiling Splice/Bracket</p>	\$2.65 ea. \$2.20 ea. /box 50 Colors +10%

TRACKS SYSTEMS

CS | CM | CCS | RTS | **KS** | **DS** | DSXL | DSXL LED

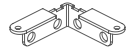
KS	DS	COMPONENT	PRICE
●	●	 3003-25 59 black, 65 brown, 90 grey +10% Heavy Duty Ceiling Bracket w/ Smart Klick	\$2.65 ea. \$2.19 ea. /box of 100
●	●	 30031-25 59 black, 65 brown, 90 grey +10% Ceiling Bracket Cover use with 3003-XX	\$1.10 ea. \$0.92 ea. /box of 100
●	●	 53202-25 59 black, 65 brown, 90 grey +10% 3" Smart Klick Wall Bracket w/ wide base, adjusts 3-4.5"	\$6.34 ea. \$5.28 ea. /box of 100
●	●	 53206-25 59 black, 65 brown, 90 grey +10% 6" Smart Klick Double Wall Bracket w/ wide base adjusts 2.5"-4" & 6"-7.5"	\$11.16 ea. \$9.30 ea. /box of 50
●	●	 3280-25 59 black, 65 brown, 90 grey +10% 3" Wall Bracket, heavy duty projection 2 1/2"	\$14.58 ea. \$12.51 ea. /box of 20
●	●	 3281-25 59 black, 65 brown, 90 grey +10% 6" Double Wall Bracket, heavy duty projection 1 1/2", 5 1/2"	\$20.90 ea. \$17.41 ea. /box of 15
●	●	 32801-25 59 black, 90 grey +10% Wall Bracket Cover use with 3280 & 3281	\$3.76 ea. \$3.13 ea. /box of 50
●	●	 2001-25 59 black, 65 brown, 90 grey +10% Klick Carrier, for pinch pleat	\$0.67 ea. \$0.57 ea. /box of 500
●	●	 2002-25 59 black, 65 brown, 90 grey +10% Shirrtape Carrier	\$0.65 ea. \$0.54 ea. /box of 500
●	●	 2004-25 59 black +10% Snap Carrier, for accordiafold	\$0.67 ea. \$0.57 ea. /box of 500
●	●	 Two Piece Connected Snap Carrier w/ Square Base, in plastic sleeve. Use 1 1/4" snap tape 2114-25, 59 black 60% fullness, 2 5/8" OC 2111-25, 65 brown, 90 grey 80% fullness, 2 3/8" OC 2112-25, 59 black 100% fullness, 2 1/8" OC 2115-25, 59 black 120% fullness, 1 7/8" OC	\$1.47 ea. \$1.23 ea. /roll of 500 Colors other than white +10%

KS	DS	COMPONENT	PRICE
●	●	 52003-25 65 brown +10% Economy Slide	\$0.35 ea. \$0.29 ea. /box of 2000
●	●	 52004-25 Low Profile Ball Bearing Carrier	\$1.84 ea. \$1.51 ea. /box of 1000
●	●	 2201-25 59 black +10% Klick Carrier w/ Stainless Hook Use with grommets 1 3/4" from top of track to bottom of J hook. 1 1/8"	\$1.78 ea. \$1.47 ea. /box of 100
●	●	 52005-25 Button Slide Carrier	\$0.28 ea. \$0.24 ea. /box of 1000
●	●	 52105-25 Button Slide Carrier w/ Hook	\$0.87 ea. \$0.73 ea. /bag of 500
●	●	 2525-25 Overlap R 2526-25 Underlap L 65 brown +10% Pinchpleat Master 2527-25 Overlap L 2528-25 Underlap R	\$15.46 ea. \$12.86 ea. /box of 25
●	●	 88809-23-00 Overlap R 88809-24-00 Underlap L 59 black +10% Plastic Snap Master	\$15.46 ea. \$12.86 ea. /box of 25
●	●	 52410-25 Butt R 52409-25 Butt L 59 black +10% Standard Butt Master w/ snaps and for baton use	\$21.38 ea. \$17.80 ea. /box of 50
●	●	 2305-25 59 black, 65 brown, 90 grey +10% Twist On End Stop	\$2.65 ea. \$2.20 ea. /box of 100
●	●	 52307-90 End Lock	\$1.18 ea. \$0.98 ea. /box of 100
●	●	 2308-25 Return Plate reversible, 2 1/2" return	\$9.98 ea. \$8.33 ea. /box of 100
●	●	 54110-25 36" Fiberglass Baton w/ snap See all batons page 19	\$9.26 ea. \$7.72 ea. /box of 100

BREAK PACK PRICING - Prices with this designation indicate a 20% up charge for broken pack quantities.

● Standard item in assembled sets.



Scan for more information on the FOREST DSXL Design System XL



25 White

DSXL® DESIGN SYSTEM DSXL® LED DESIGN SYSTEM + LED LIGHTING

- Elegantly shaped aluminum extrusion, white, powder coated and lubricated with a patented process. LED lighting lights up the backside of drapery or the track itself.
- LED strips have low energy consumption, are eco-friendly, dimmable. Lifespan is 30,000 hours.
- Maximum weight is 3 lbs/ft.
- Hand or baton draw, one or two way. Can be motorized.
- Stackback: Ripplefold - 6" per width, pinchpleat - 7" per width, cubicle - 5" per width, accordiafold - 5" per width.



MOTORIZED
P. 101-102

ASSEMBLED PRICING

Includes track, masters, pinchpleat or ripplefold carriers, wall or ceiling brackets, lighting components (if specified), and 36" white fiberglass baton (See all batons page 19). Freight is additional.

DESIGN SYSTEM XL	first 4 feet	ea. add'l foot
DSXL	\$299.72	\$41.45
DSXL LED	\$2,227.26	\$130.26

BATON OPTIONS

White fiberglass batons are available in 36", 48", 60", and 72" lengths. See all baton options, including the finishes below, on page 19.



25 White



59 Black



81 Bronze



90 Grey

TRACKS SYSTEMS

CS | CM | CCS | RTS | KS | DS | **DSXL** | **DSXL LED**

DSXL	DSXL LED	COMPONENT	PRICE	DSXL	DSXL LED	COMPONENT	PRICE
●		 <p>2119-25 DSXL Track 19' 8" x 20 tracks per bundle bundle = 393.7' cannot be spliced</p>	\$16.02/ft.	●	●	 <p>B8809-23-00 Overlap R B8809-24-00 Underlap L Plastic Snap Master</p>	\$15.45 ea.  \$12.86 ea. /box of 25
	●	 <p>3119-25 DSXL LED Track 19' 8" x 20 tracks per bundle bundle = 393.7' cannot be spliced</p>	\$17.39/ft.	●	●	 <p>9040-25 FES Butt Master</p>	\$6.22 ea.  \$5.18 ea. /box of 25
●		 <p>2400-25 DSXL End Cap</p>	\$2.89 ea. \$2.42 ea. /box of 20	●	●	 <p>2305-25 59 black, 65 brown, 90 grey +10% Twist On End Stop</p>	\$2.65 ea.  \$2.20 ea. /box of 100
●		 <p>3400-25 DSXL LED End Cap</p>	\$2.63 ea.  \$2.19 ea. /box of 20	●		 <p>3000-00 LED Strip, 3000k/24v 30,000 hr lifespan Dimmable</p>	\$70.26 ea. /19' strip \$3.70/ft.
●		 <p>3402-25 DSXL LED Flat End Cap</p>	\$2.63 ea.  \$2.19 ea. /box of 20	●		 <p>3010-00 LED Strip Cover</p>	\$72.04 ea. /19' strip \$3.79/ft.
●	●	 <p>2302-25 DSXL Swivel Ceiling Bracket</p>	\$3.11 ea.  \$2.59 ea. /box of 100	●		 <p>3030-00 Mounting Device for LED Strip</p>	\$355.60 ea.
●	●	 <p>2301-25 DSXL Wall Bracket w/ Swivel</p>	\$51.32 ea.  \$42.79 ea. /box of 5	●	●	 <p>3103-25 LED Dimmer Allows control of light strip with Diamond remote.</p>	\$287.39 ea. 1/box
●	●	 <p>Two Piece Connected Snap Carrier w/ Square Base, in plastic sleeve. Use 1 1/4" snap tape 2114-25, 59 black 60% fullness, 2 5/8" OC 2111-25, 65 brown, 90 grey 80% fullness, 2 3/8" OC 2112-25, 59 black 100% fullness, 2 1/8" OC 2115-25, 59 black 120% fullness, 1 7/8" OC</p>	\$1.47 ea.  \$1.23 ea. /roll of 500 Colors other than white +10%	●	●	 <p>3100-00 with 6' 6" cord 3105-25 with 13" cord LED Cable connects LED Strip 3000-00 to LED Dimmer 3102-25 24 volt</p>	\$35.02 ea. \$28.47 ea. 1/box
●	●	 <p>2001-25 Klick Carrier for PP</p>	\$0.67 ea.  \$0.57 ea. /box of 500	●		 <p>3106-25 LED Extension Cable for LED Cables 3100-00 and 3105-25 6' 6"</p>	\$31.63 ea. 1/box
●	●	 <p>1 3/4" from top of track to bottom of J hook. 2201-25 Klick Carrier w/ Hook</p>	\$1.78 ea.  \$1.47 ea. /box of 100	●	●	 <p>52931-25D white 59D black +10% Diamond Sense Remote RF, 15 channel w/ holder, Range 98'</p>	\$434.19 ea. 1/box

 **BREAK PACK PRICING**  - Prices with this designation indicate a 20% up charge for broken pack quantities.

● Standard item in assembled sets.

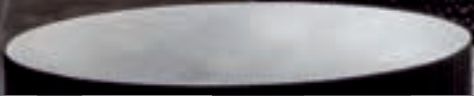
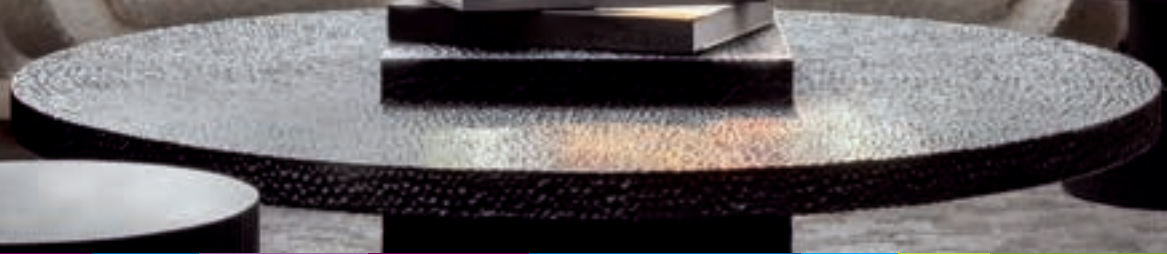



BENDS/CURVES

BENDS/CURVES, BATONS, WORKROOM and EASYFLEX

In this section find out more about bending and curving options at our facility or yours. Also consider our wide range of batons and other items for your workroom. Beyond traditional ripplefold tape, the Forest Easyflex System allows you to easily customize the fold depth of your ripplefold drapery.



BATONS



WORKROOM

THE
WORLD
BEHIND
YOUR
DRAPERIES



EASY FLEX



CUSTOM BEND & CURVE TRACKS AND H-RAIL

- Forest will custom bend and curve our hardware to your exact specifications. Or, bend and curve at your workroom with our equipment.
- All bend and curve orders require a template at actual size. Mail your template to Forest Drapery Hardware, 2500 Donn Drive, Cartersville GA 30120, Attn: Inside Sales.



CS TRACK
p. 3-6



CCS TRACK
p. 7-8



KS TRACK
p. 11-12



DS TRACK
p. 11-12



FMS TRACK
p. 95-96



DRESDEN TRAVERSE & MOTORIZED TRAVERSE p. 63-64
MOTORIZED p. 105-108
Polished chrome and wood foil cannot be bent or curved



DEVENTER CRS & MRS
CRS p. 69-70
MRS p. 109-110

PRICING

Bends: \$25.00/bend
Curves: \$20.00/ft.

Minimum Charge: \$100.00
Crating Fee: \$55.00/rod



KS/DS BENDER

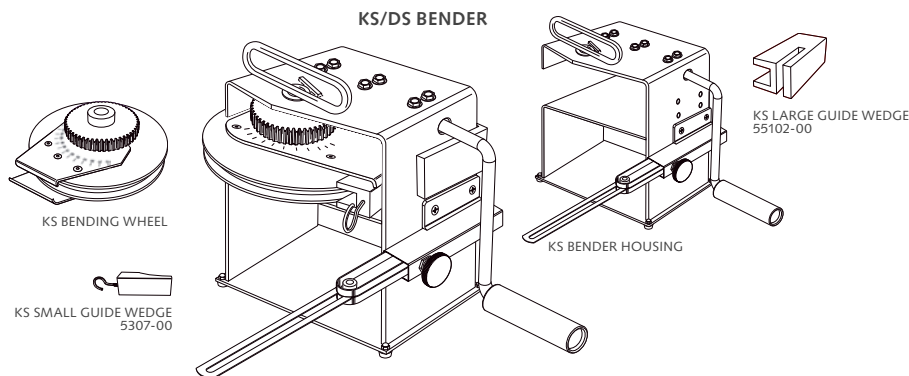

Scan for a video showing how to set up the KS/DS Bender

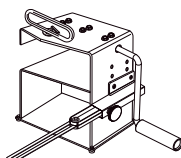
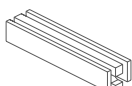
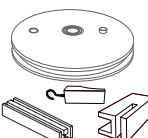

KS & DS	COMPONENT	PRICE
	KS/DS Housing Unit 5001-00	\$1,911.92 ea.
	Bending Strips 5302-00 KS 5312-00 DS	\$33.18 ea. \$135.77 ea.
	Bending Wheel Sets Includes wheel, wedges, and bending strips. 55401-00 KS 55402-00 DS	\$1,107.88/set \$2,439.86/set

KS & DS	COMPONENT	PRICE
	Small Guide Wedge 5307-00 KS (pictured) 5308-00 DS white 5309-00 DS grey Both DS wedges are required.	\$152.93 ea. \$155.47 ea. \$155.47 ea.
	Large Guide Wedge 55102-00 KS (pictured) 55103-00 DS white 55104-00 DS grey Both DS wedges are required.	\$244.68 ea. \$209.96 ea. \$209.96 ea.

BENDING & CURVING







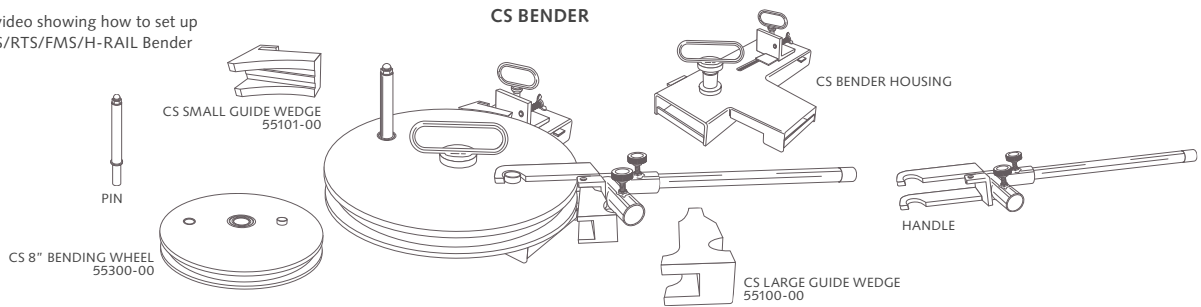

BENDING & CURVING | BATONS | WORKROOM | EASYFLEX

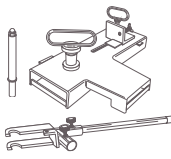
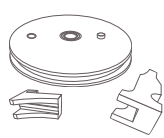
CS/CCS/FMS/H-RAIL BENDER





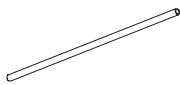



Scan for a video showing how to set up the CS/CCS/RTS/FMS/H-RAIL Bender

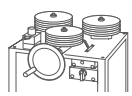

CS, CCS, FMS, H-RAIL	COMPONENT	PRICE	CS, CCS, FMS, H-RAIL	COMPONENT	PRICE
•	 CS/CCS/FMS/H-RAIL Housing Unit with handle & pin 55002-00	\$2,283.35 ea.	•	 Bending Wheels w/ wedges 55300-00 CS/CCS/FMS 55310-00 H-Rail	\$3,168.81 ea. \$3,168.83 ea.
•	 CS Bending Strip 55302-00	\$163.12 ea.	•	 Small Guide Wedge 55101-00 CS/CCS/FMS 55315-00 H-Rail	\$1,410.81 ea. \$1,410.81 ea.
•	 CCS Bending Strip 55303-00	\$163.13 ea.	•	 Large Guide Wedge 55100-00 CS/CCS/FMS 55316-00 H-Rail	\$1,410.81 ea. \$1,410.81 ea.
•	 FMS Bending Strip 55306-00	\$74.26 ea.	•	 Extension Arm for handle 55317-00	\$146.07 ea.
•	 H-Rail Bending Strip 55314-00	\$207.09 ea.	•	 Stand for CS Bender 55318-00	\$1,329.53 ea.





























KS/DS/CS/CCS/FMS/H-RAIL CURVING



CURVING	COMPONENT	PRICE	CURVING	COMPONENT	PRICE
•	 Electronic Continuous Curver 5004-00 110 Volt curver for accurate and high output curing. Wheels not included.	\$24,559.57 ea.	•	 KS Curving Strip, 23' 55308-00	\$160.03 ea.
•	 Curving Wheels, set of 3 5304-00 KS 5306-00 DS 5305-00 CS/CCS/FMS 55311-00 H-Rail	\$2,284.48/set \$1,733.14/set \$2,389.91/set \$1,474.97/set	•	 DS/CCS Curving Strip, 23' 55304-00	\$163.13 ea.
			•	 CS/FMS Curving Strip, 23' 55307-00	\$284.11 ea.
			•	 H-Rail Curving Strip, 23' 55313-00	\$144.54 ea.

BATONS







BENDS & CURVES | **BATONS** | WORKROOM | EASYFLEX

BATONS FIBERGLASS, ACRYLIC, ADA & COMPONENTS

BATONS	COMPONENT	PRICE	BATONS	COMPONENT	PRICE
 	3/8" Fiberglass Baton Must order screw separately		 	1/2" Clear Acrylic Baton Must order screw separately	
	36" 54110-25 white w/ snap \$9.26 ea.  54310-25 white w/ adaptor \$7.72 ea./box 100			36" 54510-00 w/ snap \$13.25 ea.  54710-00 w/ adaptor \$11.03 ea./box 100	
	54110-59, 81, 90 w/ snap \$16.18 ea.  \$13.49 ea./box 100			48" 54511-00 w/ snap \$25.90 ea.  54711-00 w/ adaptor \$21.59 ea./box 100	
	48" 54111-25 white w/ snap \$12.31 ea.  54311-25 white w/ adaptor \$10.25 ea./box 100			60" 54512-00 w/ snap \$29.04 ea.  54712-00 w/ adaptor \$24.20 ea./box 100	
	54111-59, 81, 90 w/ snap \$19.28 ea.  \$16.07 ea./box 100			72" 54513-00 w/ snap \$38.76 ea.  54713-00 w/ adaptor \$32.29 ea./box 100	
	60" 54112-25 white w/ snap \$19.33 ea.  54312-25 white w/ adaptor \$16.09 ea./box 100			ADA Clear Acrylic Baton	
	54112-59, 81, 90 w/ snap \$25.29 ea.  \$21.06 ea./box 100			 48" 54911-00 w/ adaptor \$68.90 ea.  \$57.43 ea./box 20	
	72" 54113-25 white w/ snap \$22.35 ea.  54313-25 white w/ adaptor \$18.63 ea./box 100			 9013-00 Baton Holder, clear acrylic \$2.46 ea. 1,000/pkg	
	54113-59, 81, 90 w/ snap \$29.34 ea.  \$24.47 ea./box 100			 54001-16 Baton Snap \$0.40 ea. 1,000/pkg	
	84" 54114-25 white w/ snap \$46.75 ea.  \$38.97 ea./box 100			 9015-00 Hex Head Shoulder Screw for baton w/ adaptor \$0.57 ea. 200/bag	
	96" 54115-25 white w/ snap \$46.75 ea.  \$38.97 ea./box 100			 54000-16 D-Ring \$0.79 ea. 1,000/pkg	
	Colors available for 3/8" Fiberglass Batons				
	 25 White  59 Black  81 Bronze  90 Grey				

 BREAK PACK PRICING  - Prices with this designation indicate a 20% up charge for broken pack quantities.











BATONS DECORATIVE METAL & WOOD



 <p>29MWAND-XX 40" Metal Baton see all finishes p. 55 \$101.40 ea.</p>	 <p>29AWAND-16 40" Round Metal Baton Stainless Steel \$106.65 ea.</p>	 <p>29SWAND-16 40" Square Metal Baton Stainless Steel \$112.30 ea.</p>	 <p>29IWAND-XX 40" Wrought Iron Baton see all finishes p. 59 \$90.18 ea.</p>	 <p>19WWAND-XX 40" Wood Baton see all finishes p. 83 \$24.47 ea. unfinished \$29.39 ea. finished \$54.72 ea. antiqued</p>	 <p>19CWAND-XX 40" Modern Baton see all finishes p. 83 \$24.47 ea. unfinished \$29.39 ea. finished \$54.72 ea. antiqued</p>
---	--	---	---	--	--

WORKROOM & EASYFLEX

BENDS & CURVES | BATONS | **WORKROOM** | **EASYFLEX**

WORKROOM COMPONENTS

WORKROOM	COMPONENT	PRICE	WORKROOM	COMPONENT	PRICE
•	 9009-00 Large Stiffener w/ grommet Adjustable for ceiling or wall	\$1.41 ea.  \$1.17 ea. /bag 500	•	 1502-00 Spray lubricant	\$47.11 ea.
•	 9011-00 Small Stiffener w/ grommet for sheers	\$1.20 ea.  \$1.00 ea. /bag 1000	•	 9100-00 Channel Protector fits CS, KS & DS Tracks	\$17.72 ea.
•	 9003-25 1" Snap Tape for Ripplefold 4 1/4" OC spacing	\$7.01/yd.  \$583.16 /roll 100 yd	•	 52500-00 Corded Assembly Tool	\$110.78 ea.
			•	 5000-00 Track Opener	\$63.93 ea.

 BREAK PACK PRICING  - Prices with this designation indicate a 20% up charge for broken pack quantities.











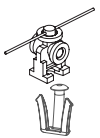

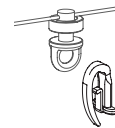

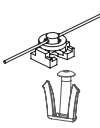
FES® FOREST EASYFLEX SYSTEM

- Fold depth is fully customizable with Easyflex tape and carriers.
- Use with any traversing system and your choice of ripplefold masters.
- Ceiling space required is equal to the spacing between the hook placement in the Easyflex tape.



Scan for more information on
FES Forest Easyflex System

FES	COMPONENT	PRICE	FES	COMPONENT	PRICE
•	 Wheeled Connected Snap Carrier in plastic sleeve 2107-25 60%, 2 5/8" OC 2106-25 80%, 2 3/8" OC 2105-25 100%, 2 1/8" OC 2108-25 120%, 1 7/8" OC	\$1.83 ea.  \$1.52 ea. /box 500	•	 2116-25 Easywave Square Carrier, 80% use with 9039-25 Easyflex End Hook	\$1.35 ea.  \$1.12 ea. /box 1000
•	 Two-Piece Connected Snap w/ Square Base in plastic sleeve 2114-25 60%, 2 5/8" OC 2111-25 80%, 2 3/8" OC 2112-25 100%, 2 1/8" OC 2115-25 120%, 1 7/8" OC	\$1.47 ea.  \$1.23 ea. /roll of 500	•	 9039-25 Easyflex End Hook	\$0.36 ea.  \$0.29 ea. /box 1000
•	 9037-25 Easyflex Hook use with 210X-25 and 211X-25 carriers	\$1.18 ea.  \$0.98 ea. /box 500	•	 9036-00 Easyflex Tape 3" wide, 9/16" spacing	\$5.24/yd.  \$524.39 /roll 100 yds

 BREAK PACK PRICING  - Prices with this designation indicate a 20% up charge for broken pack quantities.



ROLLER SHADES AND ROMANS

Forest Roller Shades and Romans are high quality for residential or commercial use. Choose a fabric from our stock program and your roller shades ship in 10-14 business days. Control options include spring, chain and motorization.



CHAIN
CONTROL



SPRING
CONTROL



MOTOR
CONTROL



APOLLO ROLLER SHADES

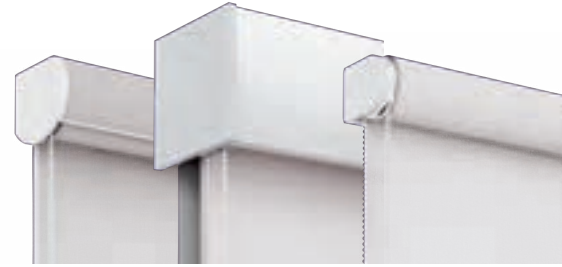

MERCURY ROLLER SHADES



ATLANTIS ROLLER SHADES



RBS & RBS XL ROMAN BLINDS



BCS® ROMAN BLINDS



ENDEAVOR ROMAN BLINDS

THE
 WORLD
 BEHIND
 YOUR
 DRAPERIES





Scan for more information on FOREST Apollo Basic Roller Shades

APOLLO CASSETTE & DIRECT MOUNT

- Wall or ceiling mount for residential or contract use
- Maximum weight is 8 lbs. 13 oz.
- 1 1/2" / 38mm tube and a bi-directional clutch



 25 White

CASSETTE MOUNT ASSEMBLED PRICING

Includes stock fabric (see pages 33-34 for all fabric options), 38mm tube, roller mechanisms, brackets, bracket covers, valance, bottom rail with end caps, and child safety device. Side channels are additional. Freight is additional.

LENGTH	WIDTH							
	24"	36"	48"	60"	72"	84"	96"	108"
24"	\$300.18	\$326.91	\$353.64	\$380.38	\$407.11	\$433.84	\$460.56	\$487.29
36"	\$365.65	\$392.38	\$419.11	\$445.84	\$472.57	\$499.30	\$526.03	\$552.76
48"	\$431.11	\$457.84	\$484.57	\$511.31	\$538.04	\$564.77	\$591.50	\$618.23
60"	\$496.59	\$523.32	\$550.05	\$576.79	\$603.52	\$630.25	\$656.98	
72"	\$562.06	\$588.79	\$615.53	\$642.26	\$668.99	\$695.71	\$722.44	
84"	\$627.53	\$654.26	\$680.98	\$707.72	\$734.45			
96"	\$693.00	\$719.73	\$746.47	\$773.20				
108"	\$758.47	\$785.20	\$811.94					



 25 White





DIRECT MOUNT ASSEMBLED PRICING

Includes stock fabric (see pages 33-34 for all fabric options), 38mm tube, roller mechanisms, brackets, bracket covers, bottom rail with end caps, and child safety device. Side channels are additional. Freight is additional.

LENGTH	WIDTH							
	24"	36"	48"	60"	72"	84"	96"	108"
24"	\$245.23	\$257.63	\$270.04	\$282.47	\$294.88	\$307.29	\$319.71	\$332.12
36"	\$310.69	\$323.11	\$335.52	\$347.93	\$360.35	\$372.76	\$385.19	\$397.60
48"	\$376.16	\$388.57	\$400.99	\$413.41	\$425.83	\$438.23	\$450.64	\$463.07
60"	\$441.64	\$454.04	\$466.45	\$478.88	\$491.29	\$503.71	\$516.11	
72"	\$507.10	\$519.52	\$531.93	\$544.35	\$556.76	\$569.17	\$581.60	
84"	\$572.57	\$584.99	\$597.40	\$609.82	\$622.23			
96"	\$638.05	\$650.45	\$662.87	\$675.29				
108"	\$703.52	\$715.93	\$728.33					

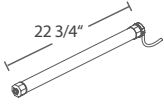
MOTORIZED CASSETTE OR DIRECT MOUNT



Choose a cassette or direct mount shade above, add the motor, the charging cable and choice of control device from below. Freight is additional. Maximum recommended weight is 16 lbs. per shade.

COMPONENT	PRICE	COMPONENT	PRICE
<ul style="list-style-type: none"> • <i>COMING SOON!</i>  22 3/4" 68002-25 1.8 Nm Tubular Lithium iOn Motor, 3-year warranty Use with Forest controls 	\$208.32 ea. 1/box	<ul style="list-style-type: none"> •  52933-25 white 59 black +10% Diamond Sense Wall Switch 2 channel Use with 68002-25 	\$213.73 ea. 1/box
<ul style="list-style-type: none"> •  78003-25 Micro USB Charging Cable for 68000-25 and 68002-25 	\$26.41 ea.	<ul style="list-style-type: none"> • <i>COMING SOON!</i>  52960-25 white 59 black +10% EasyTouch Remote RF, 6 channel Use with 68002-25 	\$303.93 ea. 1/box
<ul style="list-style-type: none"> •  52931-25D white 59D black +10% Diamond Sense Remote RF, 15 channel w/ holder, range 98' 	\$434.19 ea. 1/box		

ROLLER SHADES & ROMANS

APOLLO | MOTOR SPECIFICATIONS | MERCURY | ATLANTIS | ROLLER SHADE FABRIC | RBS | RBS XL | BCS | ENDEAVOR

CASSETTE	DIRECT	COMPONENT	PRICE	CASSETTE	DIRECT	COMPONENT	PRICE
•	•	 71119-90 1 1/2" / 38mm 19' Tube, aluminum	\$5.84/ft.	•	•	 Endless Chain 25 white plastic or 90 nickel 49020-25, 90, 29" \$2.69 ea. 49021-25, 90, 39" \$3.13 ea. 49022-25, 90, 49" \$3.87 ea. 49023-25, 90, 59" \$4.30 ea. 49024-25, 90, 69" \$4.53 ea. 49025-25, 90, 79" \$4.66 ea. 49026-25, 90, 89" \$4.81 ea. 49027-25, 90, 99" \$5.22 ea.	
•	•	 72311-25 Hold Down Strip with adhesive for tube 2,000 ft/roll	\$0.65/ft.	•	•	 79005-00 Clear Ball Stopper \$1.34 ea.  \$1.12 ea./box 500	
•	•	 72309HD-25 Heavy Duty Clutch w/ end plug	\$15.14/set 1 set/box	•	•	 49501-00 Tension Device, child safety \$10.32 ea.  \$8.59 ea./box 250	
•	•	 72306-25 Multi-Purpose Bracket steel, 2 pcs	\$5.30/set 1 set/box	•	•	 810219-25 Bottom Rail \$6.02/ft.	
•	•	 72304-25 Bracket Cover	\$2.58/set 1 set/box	•	•	 810001-25 Weight Insert for bottom rail \$9.19/ft.	
•		 72307-90 Wall Bracket steel	\$12.43 ea.	•	•	 810019-25 Adhesive Tape for bottom rail \$2.87/ft.	
•		 72308-90 Ceiling Bracket steel	\$4.85 ea.	•	•	 830004-25 End Cap for bottom rail \$1.40 ea.	
•		 71312-25 Cassette Headrail, 13'	\$7.06/ft.	•	•	 810000-00 Brush for bottom rail \$2.50/ft.	
•		 79001-25 Screw, 2 needed per headrail	\$0.14 ea.	•	•	 2 Piece Outside Mount Side Channel 71619-25 Bottom \$8.29/ft. 71719-25 Top \$7.14/ft.	
•		 72314-25 Cassette Bracket Covers	\$10.60/set	•	•	 810119-25 One Piece Inside Mount Side Channel, 19'	
•		 79001-25 Screw, 6 needed per set of 2 bracket covers	\$0.14 ea.	•	•	 79002-25 Brush for side channel \$0.86/ft.	
•		 71412-25 Cassette Valance, 13' aluminum, white	\$4.49/ft.				

 **BREAK PACK PRICING**  - Prices with this designation indicate a 20% up charge for broken pack quantities. • Standard item in assembled sets.

SEE PAGE 33-34 FOR FABRIC OPTIONS.

ROLLER SHADES APOLLO CASSETTE & DIRECT



Scan for more information on FOREST Mercury Double Fascia Roller Shades

MERCURY DOUBLE FASCIA

- Ideal for double treatment
- Complete blackout possible with side channels
- Heavy duty with quick and easy installation
- 38mm, 42mm and 50mm tube options and a bi-directional clutch

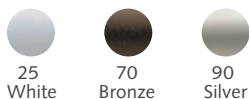

CHAIN DRAW ASSEMBLED PRICING

Includes stock fabric (see pages 33-34 for all fabric options), 38mm tube, roller mechanisms, brackets, bracket covers, counterweights or bottom rails with end caps, and child safety device. Side channels are additional. Add 10% for 42mm and 15% for 50mm. Freight is additional.

		WIDTH							
		24"	36"	48"	60"	72"	84"	96"	108"
LENGTH	24"	\$564.02	\$604.64	\$645.27	\$685.90	\$726.52	\$767.16	\$807.79	\$848.41
	36"	\$793.80	\$834.44	\$875.06	\$915.69	\$956.33	\$996.94	\$1,037.57	\$1,078.20
	48"	\$1,023.60	\$1,064.22	\$1,104.85	\$1,145.48	\$1,186.11	\$1,226.73	\$1,267.37	\$1,307.99
	60"	\$1,253.39	\$1,294.01	\$1,334.65	\$1,375.27	\$1,415.90	\$1,456.52	\$1,497.15	
	72"	\$1,483.19	\$1,523.80	\$1,564.43	\$1,605.06	\$1,645.69	\$1,686.32		
	84"	\$1,712.97	\$1,753.60	\$1,794.22	\$1,834.86	\$1,875.48			
	96"	\$1,942.76	\$1,983.40	\$2,024.01	\$2,064.64				
	108"	\$2,172.54	\$2,213.18	\$2,253.80					

SPRING CONTROL ASSEMBLED PRICING

Includes stock fabric (see pages 33-34 for all fabric options), 38mm tube, roller mechanisms, brackets, bracket covers, and counterweights or bottom rails with end caps. Side channels are additional. Add 10% for 42mm and 15% for 50mm. Freight is additional.

		WIDTH							
		24"	36"	48"	60"	72"	84"	96"	108"
LENGTH	24"	\$676.82	\$725.57	\$774.32	\$823.08	\$871.83	\$920.59	\$969.35	\$1,018.10
	36"	\$952.56	\$1,001.33	\$1,050.07	\$1,098.83	\$1,147.59	\$1,196.33	\$1,245.09	\$1,293.84
	48"	\$1,228.32	\$1,277.06	\$1,325.83	\$1,374.57	\$1,423.33	\$1,472.08	\$1,520.84	\$1,569.59
	60"	\$1,504.07	\$1,552.82	\$1,601.58	\$1,650.33	\$1,699.09	\$1,747.82	\$1,796.58	
	72"	\$1,779.82	\$1,828.56	\$1,877.32	\$1,926.08	\$1,974.83	\$2,023.59		
	84"	\$2,055.56	\$2,104.32	\$2,153.07	\$2,201.83	\$2,250.58			
	96"	\$2,331.31	\$2,380.07	\$2,428.81	\$2,477.57				
	108"	\$2,607.05	\$2,655.81	\$2,704.56					

MOTORIZED ASSEMBLED PRICING

Includes stock fabric (see pages 33-34 for all fabric options), two 38mm tubes, motor, micro usb cable to charge battery, brackets, bracket covers, counterweight or bottom rail with end caps and remote. Side channels are additional. Add 10% for 42mm and 15% for 50mm. Freight is additional.

		WIDTH							
		24"	36"	48"	60"	72"	84"	96"	108"
LENGTH	24"	\$1,947.19	\$1,987.85	\$2,028.53	\$2,069.19	\$2,109.86	\$2,150.53	\$2,191.18	\$2,231.86
	36"	\$2,068.28	\$2,108.95	\$2,149.63	\$2,190.29	\$2,230.96	\$2,271.61	\$2,312.28	\$2,352.94
	48"	\$2,189.38	\$2,230.05	\$2,270.71	\$2,311.39	\$2,352.04	\$2,392.71	\$2,433.38	\$2,474.04
	60"	\$2,310.48	\$2,351.14	\$2,391.81	\$2,432.49	\$2,473.14	\$2,513.81	\$2,554.47	
	72"	\$2,431.58	\$2,472.24	\$2,512.91	\$2,553.56	\$2,594.24	\$2,634.91		
	84"	\$2,552.67	\$2,593.34	\$2,634.00	\$2,674.66	\$2,715.33			
	96"	\$2,673.77	\$2,714.43	\$2,755.09	\$2,795.76				
	108"	\$2,794.87	\$2,835.53	\$2,876.19					



NEW! OPERATE MERCURY SHADES WITH BOND BRIDGE PRO!













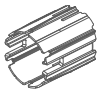

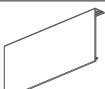
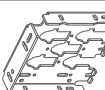
52955-25

Bond Bridge Pro
\$379.00



No discounts on this item

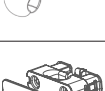









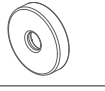



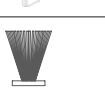

ROLLER SHADES & ROMANS

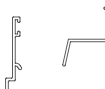
APOLLO BASIC | **MERCURY DECORATIVE** | ATLANTIS HEAVY DUTY | ROLLER SHADE FABRIC | RBS | RBS XL | BCS | ENDEAVOR

FASCIA	COMPONENT	PRICE
●	 Aluminum Tube, 19' 77003-90 38mm \$6.08/ft. 77002-90 42mm \$11.76/ft. 77001-90 50mm \$16.49/ft.	
●	 76013-XX Clutch Mechanism Plastic, 38mm \$25.70 ea.	
●	 76003-25 Tube Adaptor 42mm, 50mm \$1.94 ea.	
●	 Easy Mount End Plug 76005-XX 38mm \$3.04 ea. 76004-XX 42mm, 50mm \$3.85 ea.	
●	 77010-XX Fascia Front, 19' \$22.66/ft.	
●	 76050-XX Fascia Box Bracket \$34.03 ea.	
●	 76051-90 Box Bracket Attachment Adaptor \$6.29/set	
●	 76052-XX Box Bracket End Caps \$12.13/set	
●	 Endless Chain 25 white plastic or 90 nickel 49020-25, 90, 29" \$2.69 ea. 49021-25, 90, 39" \$3.13 ea. 49022-25, 90, 49" \$3.87 ea. 49023-25, 90, 59" \$4.30 ea. 49024-25, 90, 69" \$4.53 ea. 49025-25, 90, 79" \$4.66 ea. 49026-25, 90, 89" \$4.81 ea. 49027-25, 90, 99" \$5.22 ea.	
●	 79005-00 Clear Ball Stopper \$1.34 ea.  \$1.12 ea./box 500	
●	 49501-00 Tension Device, child safety \$10.32 ea.  \$8.59 ea./box 250	
●	 76053-25 Chain Guide Adaptor, long \$3.18 ea.	
●	 76054-25 Chain Guide Adaptor \$5.89 ea.	

SEE PAGE 33-34 FOR FABRIC OPTIONS.

 **BREAK PACK PRICING**  - Prices with this designation indicate a 20% up charge for broken pack quantities. ● Standard item in assembled sets.

FASCIA	COMPONENT	PRICE
●	 76002-XX Fill up Ring \$1.70 ea.	
●	 76001-XX Bearing Pin \$2.47 ea.	
●	 810219-25 Bottom Rail \$6.02/ft.	
●	 810001-25 Weight Insert for bottom rail \$9.19/ft.	
●	 810019-25 Adhesive Tape for bottom rail \$2.87/ft.	
●	 830004-25 End Cap for bottom rail \$1.40 ea.	
●	 810000-00 Brush for bottom rail \$2.50/ft.	
●	 76073-25 Grip for bottom rail \$6.61 ea.	
●	 2 Piece Outside Mount Side Channel 71619-25 Bottom \$8.29/ft. 71719-25 Top \$7.14/ft.	
●	 810119-25 One Piece Inside Mount Side Channel, 19' \$16.34/ft.	
●	 79002-25 Brush for side channel \$0.86/ft.	
●	 78000-25 Motor & lithium battery \$606.50 ea.	
●	 Drive for Mercury Motor 78001-25 38mm \$20.69 ea. 78020-25 42mm, 50mm \$20.69 ea.	
●	 Crown Adaptor for Mercury Motor 78002-25 38mm \$6.25 ea. 78010-25 42mm, 50mm \$6.04 ea.	
●	 78003-25 Micro USB Cable for motor for Mercury Motor, 9.8 ft. \$26.41 ea.	
●	 78004-59 Remote for Mercury Motor, 5 channel, black \$130.63 ea.	

ROLLER SHADES MERCURY DOUBLE FASCIA



Scan for more information on FOREST Mercury Semi Open Roller Shades

MERCURY SEMI OPEN MOUNT

- Luxury installation cassette
- As a double, closes perfectly when blind is pulled down
- Almost no light gap on the top due to installation clip
- 38mm, 42mm and 50mm tube options and a bi-directional clutch

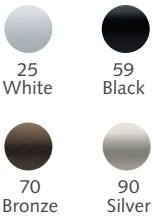

CHAIN DRAW ASSEMBLED PRICING

Includes stock fabric (see pages 33-34 for all fabric options), 38mm tube, roller mechanisms, brackets, bracket covers, and counterweight or bottom rail with end caps. Side channels are additional. Add 10% for 42mm and 15% for 50mm. Freight is additional.

LENGTH	WIDTH							
	24"	36"	48"	60"	72"	84"	96"	108"
24"	\$322.04	\$356.91	\$391.78	\$426.65	\$461.53	\$496.40	\$531.27	\$566.14
36"	\$388.10	\$422.97	\$457.84	\$492.71	\$527.59	\$562.46	\$597.34	\$632.21
48"	\$443.55	\$478.43	\$513.30	\$548.18	\$583.05	\$617.92	\$652.80	\$687.67
60"	\$499.02	\$533.89	\$568.77	\$603.64	\$638.51	\$673.38	\$708.25	
72"	\$554.48	\$589.35	\$624.22	\$659.09	\$693.97	\$728.84		
84"	\$609.92	\$644.80	\$679.67	\$714.54	\$749.41			
96"	\$665.38	\$700.25	\$735.12	\$770.00				
108"	\$720.84	\$755.71	\$790.58					

SPRING CONTROL ASSEMBLED PRICING

Includes stock fabric (see pages 33-34 for all fabric options), 38mm tube, roller mechanisms, brackets, bracket covers, and counterweight or bottom rail with end caps. Side channels are additional. Add 10% for 42mm and 15% for 50mm. Freight is additional.

LENGTH	WIDTH							
	24"	36"	48"	60"	72"	84"	96"	108"
24"	\$386.45	\$428.29	\$470.14	\$511.99	\$553.83	\$595.68	\$637.52	\$679.37
36"	\$465.72	\$507.56	\$549.41	\$591.26	\$633.10	\$674.95	\$716.81	\$758.65
48"	\$532.27	\$574.11	\$615.96	\$657.82	\$699.66	\$741.51	\$783.36	\$825.20
60"	\$598.83	\$640.67	\$682.52	\$724.36	\$766.21	\$808.06	\$849.90	
72"	\$665.37	\$707.22	\$749.07	\$790.91	\$832.76	\$874.60		
84"	\$731.91	\$773.75	\$815.60	\$857.45	\$899.29			
96"	\$798.46	\$840.30	\$882.15	\$923.99				
108"	\$865.00	\$906.85	\$948.70					

MOTORIZED ASSEMBLED PRICING

Includes stock fabric (see pages 33-34 for all fabric options), 38mm tube, motor, micro usb cable to charge battery, brackets, bracket covers, bottom rail with end caps and remote. Side channels are additional. Add 10% for 42mm and 15% for 50mm. Freight is additional.

LENGTH	WIDTH							
	24"	36"	48"	60"	72"	84"	96"	108"
24"	\$1,127.63	\$1,168.05	\$1,208.46	\$1,248.88	\$1,289.30	\$1,329.72	\$1,370.13	\$1,410.55
36"	\$1,193.08	\$1,233.50	\$1,273.92	\$1,314.33	\$1,354.76	\$1,395.18	\$1,435.60	\$1,476.01
48"	\$1,258.54	\$1,298.96	\$1,339.38	\$1,379.80	\$1,420.21	\$1,460.63	\$1,501.05	\$1,541.47
60"	\$1,323.99	\$1,364.42	\$1,404.84	\$1,445.26	\$1,485.67	\$1,526.09	\$1,566.51	
72"	\$1,389.46	\$1,429.87	\$1,470.29	\$1,510.71	\$1,551.13	\$1,591.54		
84"	\$1,454.92	\$1,495.34	\$1,535.75	\$1,576.17	\$1,616.59			
96"	\$1,520.37	\$1,560.79	\$1,601.22	\$1,641.63				
108"	\$1,585.83	\$1,626.25	\$1,666.67					



NEW! OPERATE MERCURY SHADES WITH BOND BRIDGE PRO!











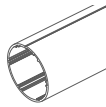

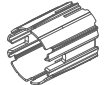
52955-25

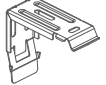
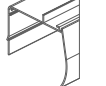











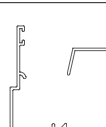

Bond Bridge Pro \$379.00

No discounts on this item

ROLLER SHADES & ROMANS

APOLLO BASIC | **MERCURY DECORATIVE** | ATLANTIS HEAVY DUTY | ROLLER SHADE FABRIC | RBS | RBS XL | BCS | ENDEAVOR

SEMI OPEN	COMPONENT	PRICE
•	 Aluminum Tube, 19' 77003-90 38mm \$6.08/ft. 77002-90 42mm \$11.76/ft. 77001-90 50mm \$16.49/ft.	
•	 76013-XX Clutch Mechanism Plastic, 38mm \$25.70 ea.	
•	 76003-25 Tube Adaptor 42mm, 50mm \$1.94 ea.	
•	 Easy Mount End Plug 76005-XX 38mm \$3.04 ea. 76004-XX 42mm, 50mm \$3.85 ea.	
•	 76019-XX Semi Open Bracket for Cassette \$9.28 ea.	
•	 77008-XX Semi Open Cassette, 19' \$21.53/ft.	
•	 77007-XX Semi Open Cassette End Cap Set \$10.74/set	
•	 76018-90 Cassette Set \$13.03/set	
•	 Endless Chain 25 white plastic or 90 nickel 49020-25, 90 , 29" \$2.69 ea. 49021-25, 90 , 39" \$3.13 ea. 49022-25, 90 , 49" \$3.87 ea. 49023-25, 90 , 59" \$4.30 ea. 49024-25, 90 , 69" \$4.53 ea. 49025-25, 90 , 79" \$4.66 ea. 49026-25, 90 , 89" \$4.81 ea. 49027-25, 90 , 99" \$5.22 ea.	
•	 79005-00 Clear Ball Stopper \$1.34 ea.  \$1.12 ea./box 500	
•	 49501-00 Tension Device, child safety \$10.32 ea.  \$8.59 ea./box 250	
•	 76002-XX Fill up Ring \$1.70 ea.	
•	 76001-XX Bearing Pin \$2.47 ea.	

SEMI OPEN	COMPONENT	PRICE
•	 810219-25 Bottom Rail \$6.02/ft.	
•	 810001-25 Weight Insert for bottom rail \$9.19/ft.	
•	 810019-25 Adhesive Tape for bottom rail \$2.87/ft.	
•	 830004-25 End Cap for bottom rail \$1.40 ea.	
•	 810000-00 Brush for bottom rail \$2.50/ft.	
•	 76073-25 Grip for bottom rail \$6.61 ea.	
•	 2 Piece Outside Mount Side Channel 71619-25 Bottom \$8.29/ft. 71719-25 Top \$7.14/ft.	
•	 810119-25 One Piece Inside Mount Side Channel, 19' \$16.34/ft.	
•	 79002-25 Brush for side channel \$0.86/ft.	
•	 78000-25 Motor & lithium battery \$606.50 ea.	
•	 Drive for Mercury Motor 78001-25 38mm \$20.69 ea. 78020-25 42mm, 50mm \$20.69 ea.	
•	 Crown Adaptor for Mercury Motor 78002-25 38mm \$6.25 ea. 78010-25 42mm, 50mm \$6.04 ea.	
•	 78003-25 Micro USB Cable for Mercury Motor, 9.8 ft. \$26.41 ea.	
•	 78004-59 Remote for Mercury Motor, 5 channel, black \$130.63 ea.	

 **BREAK PACK PRICING**  - Prices with this designation indicate a 20% up charge for broken pack quantities. • Standard item in assembled sets.

SEE PAGE 33-34 FOR FABRIC OPTIONS.



Scan for more information on
FOREST Mercury Direct Mount
Roller Shades

MERCURY DIRECT MOUNT

- End caps in designer colors
- Contemporary, clean look
- Easy Installation
- 38mm, 42mm and 50mm tube options and a bi-directional clutch



CHAIN DRAW ASSEMBLED PRICING

Includes stock fabric (see pages 33-34 for all fabric options), 38mm tube, roller mechanisms, brackets, bracket covers, and counterweight or bottom rail with end caps. Side channels are additional. Add 10% for 42mm and 15% for 50mm. Freight is additional.

		WIDTH							
		24"	36"	48"	60"	72"	84"	96"	108"
LENGTH	24"	\$317.11	\$325.66	\$334.22	\$342.75	\$351.31	\$359.86	\$368.40	\$376.95
	36"	\$372.55	\$381.10	\$389.66	\$398.20	\$406.76	\$415.29	\$423.85	\$432.38
	48"	\$428.00	\$436.55	\$445.10	\$453.64	\$462.19	\$470.74	\$479.28	\$487.83
	60"	\$483.45	\$491.99	\$500.54	\$509.08	\$517.64	\$526.17	\$534.73	
	72"	\$538.88	\$547.43	\$555.98	\$564.52	\$573.07	\$581.62		
	84"	\$594.33	\$602.87	\$611.42	\$619.96	\$628.52			
	96"	\$649.76	\$658.31	\$666.87	\$675.40				
	108"	\$705.21	\$713.76	\$722.30					

SPRING CONTROL ASSEMBLED PRICING

Includes stock fabric (see pages 33-34 for all fabric options), 38mm tube, roller mechanisms, brackets, bracket covers, and counterweight or bottom rail with end caps. Side channels are additional. Add 10% for 42mm and 15% for 50mm. Freight is additional.

		WIDTH							
		24"	36"	48"	60"	72"	84"	96"	108"
LENGTH	24"	\$380.53	\$390.79	\$401.06	\$411.30	\$421.57	\$431.83	\$442.08	\$452.34
	36"	\$447.06	\$457.33	\$467.59	\$477.84	\$488.11	\$498.35	\$508.62	\$518.86
	48"	\$513.60	\$523.86	\$534.12	\$544.37	\$554.63	\$564.88	\$575.14	\$585.40
	60"	\$580.14	\$590.38	\$600.65	\$610.89	\$621.16	\$631.41	\$641.67	
	72"	\$646.66	\$656.92	\$667.17	\$677.43	\$687.68	\$697.94		
	84"	\$713.20	\$723.44	\$733.71	\$743.95	\$754.22			
	96"	\$779.72	\$789.97	\$800.24	\$810.49				
	108"	\$846.25	\$856.51	\$866.76					

MOTORIZED ASSEMBLED PRICING

Includes stock fabric (see pages 33-34 for all fabric options), 38mm tubes, motor, micro usb cable to charge battery, brackets, bracket covers, counterweight or bottom rail with end caps and remote. Side channels are additional. Add 10% for 42mm and 15% for 50mm. Freight is additional.

		WIDTH							
		24"	36"	48"	60"	72"	84"	96"	108"
LENGTH	24"	\$1,075.40	\$1,098.86	\$1,122.32	\$1,145.77	\$1,169.22	\$1,192.68	\$1,216.13	\$1,239.59
	36"	\$1,140.90	\$1,164.35	\$1,187.80	\$1,211.27	\$1,234.72	\$1,258.18	\$1,281.62	\$1,305.08
	48"	\$1,206.40	\$1,229.85	\$1,253.31	\$1,276.77	\$1,300.22	\$1,323.67	\$1,347.13	\$1,370.58
	60"	\$1,271.90	\$1,295.34	\$1,318.80	\$1,342.25	\$1,365.72	\$1,389.17	\$1,412.62	
	72"	\$1,337.39	\$1,360.84	\$1,384.30	\$1,407.75	\$1,431.20	\$1,454.66		
	84"	\$1,402.89	\$1,426.35	\$1,449.79	\$1,473.25	\$1,496.70			
	96"	\$1,468.38	\$1,491.84	\$1,515.29	\$1,538.75				
	108"	\$1,533.89	\$1,557.34	\$1,580.79					



NEW! OPERATE MERCURY SHADES WITH BOND BRIDGE PRO!











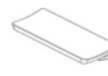

52955-25

Bond Bridge Pro
\$379.00
No discounts on this item

ROLLER SHADES & ROMANS

APOLLO BASIC | **MERCURY DECORATIVE** | ATLANTIS HEAVY DUTY | ROLLER SHADE FABRIC | RBS | RBS XL | BCS | ENDEAVOR

DIRECT	COMPONENT	PRICE
•	 Aluminum Tube, 19' 77003-90 38mm \$6.08/ft. 77002-90 42mm \$11.76/ft. 77001-90 50mm \$16.49/ft.	
•	 76013-25, 59, 70, 90, 99 \$25.70 ea. Clutch Mechanism Plastic, 38mm	
•	 76003-25 \$1.94 ea. Tube Adaptor 42mm, 50mm	
•	 Easy Mount End Plug 76005-25, 59, 70, 90, 99 38mm \$3.04 ea. 76004-25, 59, 70, 90, 99 42mm, 50mm \$3.85 ea.	
•	 76010-25, 59, 70, 90, 99 \$4.76 ea. Metal Bracket	
•	 76006-25, 59, 70, 90, 99 \$3.22 ea. End Cap, Plastic	
•	 76007-16, 22, 25 \$27.54 ea. End Cap Metal	
•	 Endless Chain 25 white plastic or 90 nickel 49020-25, 90, 29" \$2.69 ea. 49021-25, 90, 39" \$3.13 ea. 49022-25, 90, 49" \$3.87 ea. 49023-25, 90, 59" \$4.30 ea. 49024-25, 90, 69" \$4.53 ea. 49025-25, 90, 79" \$4.66 ea. 49026-25, 90, 89" \$4.81 ea. 49027-25, 90, 99" \$5.22 ea.	
•	 79005-00 \$1.34 ea.  Clear Ball Stopper \$1.12 ea./box 500	
•	 49501-00 \$10.32 ea.  Tension Device, child safety \$8.59 ea./box 250	
•	 76002-XX \$1.70 ea. Fill up Ring	
•	 76001-XX \$2.47 ea. Bearing Pin	

DIRECT	COMPONENT	PRICE
•	 810219-25 \$6.02/ft. Bottom Rail	
•	 810001-25 \$9.19/ft. Weight Insert for bottom rail	
•	 810019-25 \$2.87/ft. Adhesive Tape for bottom rail	
•	 830004-25 \$1.40 ea. End Cap for bottom rail	
•	 810000-00 \$2.50/ft. Brush for bottom rail	
•	 76073-25 \$6.61 ea. Grip for bottom rail	
•	 2 Piece Outside Mount Side Channel 71619-25 Bottom \$8.29/ft. 71719-25 Top \$7.14/ft.	
•	 810119-25 \$16.34/ft. One Piece Inside Mount Side Channel, 19'	
•	 79002-25 \$0.86/ft. Brush for side channel	
•	 78000-25 \$606.50 ea. Motor & lithium battery	
•	 Drive for Mercury Motor 78001-25 38mm \$20.69 ea. 78020-25 42mm, 50mm \$20.69 ea.	
•	 Crown Adaptor for Mercury Motor 78002-25 38mm \$6.25 ea. 78010-25 42mm, 50mm \$6.04 ea.	
•	 78003-25 \$26.41 ea. Micro USB Cable for Mercury Motor, 9.8 ft.	
•	 78004-59 \$130.63 ea. Remote for Mercury Motor, 5 channel, black	

 **BREAK PACK PRICING**  - Prices with this designation indicate a 20% up charge for broken pack quantities. • Standard item in assembled sets.

SEE PAGE 33-34 FOR FABRIC OPTIONS.



Scan for more information on
FOREST Atlantis HD Motorized
Roller Shades

ATLANTIS HEAVY DUTY MOTORIZED ROLLER SHADES



- Atlantis is a heavy duty system with a maximum weight of 45 lbs. Includes a 10-year warranty.
- Easy Installation with universal adjustable brackets
- 50mm and 60mm tube options and a bi-directional clutch



**NEW! OPERATE
ATLANTIS SHADES WITH
BOND BRIDGE PRO!**

52955-25
Bond Bridge Pro
\$379.00
No discounts
on this item

CASSETTE MOUNT ASSEMBLED PRICING

Includes stock fabric (see pages 33-34 for all fabric options), tube, roller mechanism, brackets, bracket covers, cassette cover, motor, Diamond remote or wall switch, & bottom rail w/ end caps. Designer fabrics +20%. Exclusive fabrics +40%. Side channels are additional. Freight is additional.

LENGTH	WIDTH									
	50 mm diameter tube included. +20% for 60 mm				60 mm diameter tube included.and recommended at these widths					
	24"	36"	48"	60"	72"	84"	96"	108"	120"	
24"	\$1,266.18	\$1,307.57	\$1,348.95	\$1,390.34	\$1,431.71	\$1,481.07	\$1,522.96	\$1,564.84	\$1,606.73	
36"	\$1,319.59	\$1,360.97	\$1,402.35	\$1,443.74	\$1,485.13	\$1,534.47	\$1,576.36	\$1,618.25	\$1,660.14	
48"	\$1,372.99	\$1,414.37	\$1,455.76	\$1,497.14	\$1,538.53	\$1,587.88	\$1,629.76	\$1,671.65	\$1,713.54	
60"	\$1,426.39	\$1,467.78	\$1,509.16	\$1,550.54	\$1,591.92	\$1,641.29	\$1,683.18	\$1,725.05	\$1,766.94	
72"	\$1,479.80	\$1,521.18	\$1,562.57	\$1,603.95	\$1,645.34	\$1,694.68	\$1,736.57	\$1,778.46	\$1,820.35	
84"	\$1,533.20	\$1,574.58	\$1,615.97	\$1,657.35	\$1,698.74	\$1,748.09	\$1,789.97	\$1,831.86	\$1,873.75	
96"	\$1,586.61	\$1,627.99	\$1,669.37	\$1,710.76	\$1,752.13	\$1,801.50	\$1,843.39	\$1,885.27	\$1,927.14	
108"	\$1,640.00	\$1,681.39	\$1,722.78	\$1,764.16	\$1,805.55	\$1,854.89	\$1,896.78	\$1,938.67	\$1,980.56	
120"	\$1,693.41	\$1,734.79	\$1,776.18	\$1,817.56	\$1,858.95	\$1,908.29	\$1,950.18	\$1,992.07	\$2,033.96	
132"	\$1,746.82	\$1,788.21	\$1,829.58	\$1,870.97	\$1,912.34	\$1,961.71	\$2,003.59	\$2,045.47	\$2,087.36	
144"	\$1,800.22	\$1,841.60	\$1,882.99	\$1,924.37	\$1,965.76	\$2,015.10	\$2,057.00	\$2,098.89	\$2,140.77	

DIRECT MOUNT ASSEMBLED PRICING

Includes stock fabric (see pages 33-34 for all fabric options), tube, roller mechanism, brackets, bracket covers, motor, Diamond remote or wall switch, & bottom rail with end caps. Designer fabrics +20%. Exclusive fabrics +40%. Side channels are additional. Freight is additional.

LENGTH	WIDTH									
	50 mm diameter tube included. +20% for 60 mm				60 mm diameter tube included.and recommended at these widths					
	24"	36"	48"	60"	72"	84"	96"	108"	120"	
24"	\$1,239.36	\$1,266.74	\$1,294.12	\$1,321.50	\$1,348.86	\$1,384.20	\$1,412.10	\$1,439.99	\$1,467.87	
36"	\$1,292.77	\$1,320.14	\$1,347.52	\$1,374.90	\$1,402.27	\$1,437.60	\$1,465.50	\$1,493.39	\$1,521.28	
48"	\$1,346.18	\$1,373.55	\$1,400.91	\$1,428.29	\$1,455.67	\$1,491.02	\$1,518.90	\$1,546.79	\$1,574.68	
60"	\$1,399.57	\$1,426.95	\$1,454.33	\$1,481.70	\$1,509.07	\$1,544.42	\$1,572.31	\$1,600.20	\$1,628.08	
72"	\$1,452.98	\$1,480.35	\$1,507.73	\$1,535.11	\$1,562.49	\$1,597.81	\$1,625.72	\$1,653.60	\$1,681.49	
84"	\$1,506.39	\$1,533.76	\$1,561.12	\$1,588.50	\$1,615.88	\$1,651.23	\$1,679.11	\$1,707.01	\$1,734.89	
96"	\$1,559.78	\$1,587.16	\$1,614.54	\$1,641.91	\$1,669.28	\$1,704.63	\$1,732.52	\$1,760.40	\$1,788.30	
108"	\$1,613.19	\$1,640.56	\$1,667.94	\$1,695.32	\$1,722.70	\$1,758.03	\$1,785.93	\$1,813.81	\$1,841.70	
120"	\$1,666.60	\$1,693.97	\$1,721.34	\$1,748.72	\$1,776.10	\$1,811.44	\$1,839.33	\$1,867.22	\$1,895.10	
132"	\$1,719.99	\$1,747.37	\$1,774.76	\$1,802.12	\$1,829.49	\$1,864.84	\$1,892.73	\$1,920.61	\$1,948.51	
144"	\$1,773.41	\$1,800.77	\$1,828.15	\$1,855.53	\$1,882.91	\$1,918.24	\$1,946.14	\$1,974.02	\$2,001.91	

ROLLER SHADES & ROMANS

APOLLO BASIC | MERCURY DECORATIVE | **ATLANTIS HEAVY DUTY** | ROLLER SHADE FABRIC | RBS | RBS XL | BCS | ENDEAVOR

ATLANTIS	COMPONENT	PRICE	ATLANTIS	COMPONENT	PRICE
•	 <p>Aluminum Tube, 19' 815019-00 50mm for shades up to 72" 816019-00 60mm for shades up to 144"</p>	\$16.34/ft. \$20.23/ft.	•	 <p>2 Piece Outside Mount Side Channel 71619-25 Bottom 71719-25 Top</p>	\$8.29/ft. \$7.14/ft.
•	 <p>82CL01-25 Left 82CR01-25 Right Standard Ceiling/Wall Idler Brackets</p>	\$59.85 ea.	•	 <p>79002-25 Brush for side channel</p>	\$0.86/ft.
•	 <p>820003-25 Middle Adjustable Ceiling Cassette Idler Bracket</p>	\$73.25 ea.	•	 <p>62901-25 Forest Tubular Motor built-in RF receiver, 35mm, 110v, 6 Nm</p>	\$738.09 ea.
•	 <p>82CL00-25 Left 82CR00-25 Right Standard Ceiling/Wall Motor Bracket</p>	\$36.39 ea.	•	 <p>835000-00 50mm Motor Adaptor</p>	\$34.81 ea.
•	 <p>820004-25 Middle Adjustable Ceiling Connecting Bracket</p>	\$61.54 ea.	•	 <p>835001-00 50mm Idler</p>	\$3.44 ea.
•	 <p>820005-25 Middle Adjustable Ceiling Cassette Connecting Bracket</p>	\$67.02 ea.	•	 <p>835002-00 50mm Connector Idler</p>	\$3.44 ea.
•	 <p>810319-25 Cassette Cover, 19'</p>	\$16.71/ft.	•	 <p>835003-00 50mm Adjustable Idler</p>	\$42.89 ea.
•	 <p>830001-25 Bracket End Cap</p>	\$4.38 ea.	•	 <p>836000-00 60mm Motor Adaptor</p>	\$40.56 ea.
•	 <p>830002-25 Middle Bracket Cover</p>	\$4.18 ea.	•	 <p>836001-00 60mm Idler</p>	\$5.57 ea.
•	 <p>810219-25 Bottom Rail</p>	\$6.02/ft.	•	 <p>52931-25D white 59D black +10% Diamond Remote RF, 15 channel w/ holder Range 98'</p>	\$434.19 ea. 1/box
•	 <p>810001-25 Weight Insert for bottom rail</p>	\$9.19/ft.	•	 <p>52933-25 white 59 black +10% Diamond Wall Switch 2 channel</p>	\$213.73 ea. 1/box
•	 <p>810019-25 Adhesive Tape for bottom rail and tube attachment</p>	\$2.87/ft.	•	<p><i>COMING SOON!</i></p>  <p>52960-25 white 59 black +10% EasyTouch Remote RF, 6 channel</p>	\$303.93 ea. 1/box
•	 <p>830004-25 End Cap for bottom rail</p>	\$1.40 ea.	•	 <p>52947-25 Wireless Connector One-way transmitter to control drapery by third party app or home automation.</p>	\$268.91 ea. 1/box
•	 <p>810000-00 Brush for bottom rail</p>	\$2.50/ft.			
•	 <p>810119-25 One Piece Inside Mount Side Channel, 19'</p>	\$16.34/ft.			

SEE PAGE 33-34 FOR FABRIC OPTIONS.

STOCK ROLLER SHADE FABRICS

OUR STOCK ROLLER SHADE FABRIC PROGRAM is designed to offer you design trends in each of three categories - screens, light filtering, and blackout. We believe you will find a color and performance factor to meet your needs within this offering. Fabrics were also selected to work together in a single color palette when you need to pair a screen or light filtering fabric with a blackout. This is helpful when using a double roller shade system or when a single room has a variety of shading requirements.

All fabrics are suitable for any of our roller shade systems.

Fabric images are a close representation, but for best results please email sales@forestdh.com to order a swatch card.

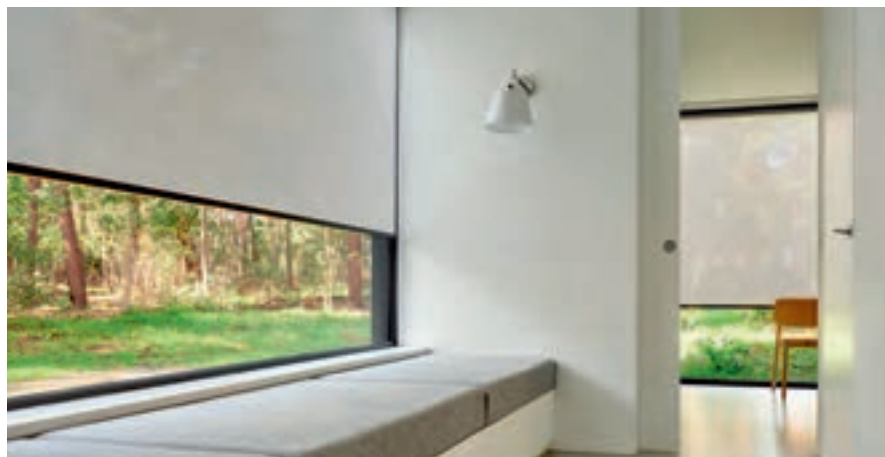

SCREENS

With two openness factors, 3% and 5%, our screen collection offers the ideal solution for all needs in terms of heat and/or light management. Screen fabrics are made of high-quality polyester yarns for strength and durability.

Flame retardant - 118 in. wide

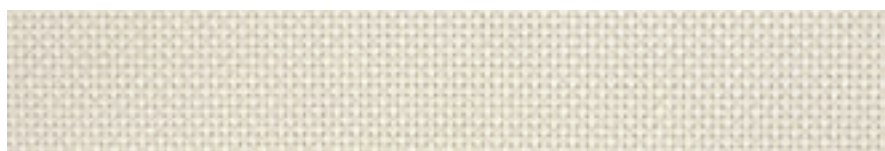

WHITE
74002-99

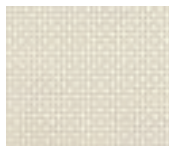

WHITE CREAM
74004-97

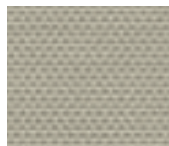

BEIGE CREAM
74020-81

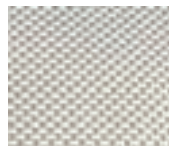

WHITE GREY
74002-18



BLACK GREY
74003-55



BLACK
74002-59

ROLLER SHADES & ROMANS

APOLLO BASIC | MERCURY DECORATIVE | ATLANTIS HEAVY DUTY | **ROLLER SHADE FABRIC** | RBS | RBS XL | BCS | ENDEAVOR



LIGHT FILTERING

Our light filtering collection offers transparent fabric that filters the light in a delicate way. The inspired fabric is available in a range of timeless colors.

Flame retardant - 94 in. wide

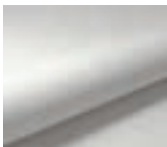
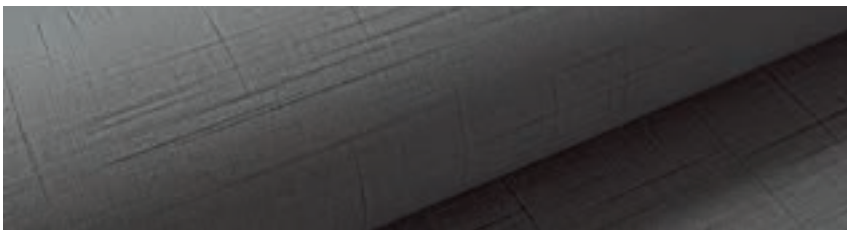

WHITE
75001-04

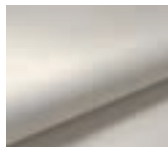

CREAM
75001-16



SAND
75001-17

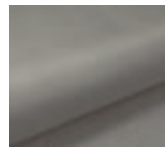

MIST
75001-18



SLATE
75001-19



BLACK
75001-20

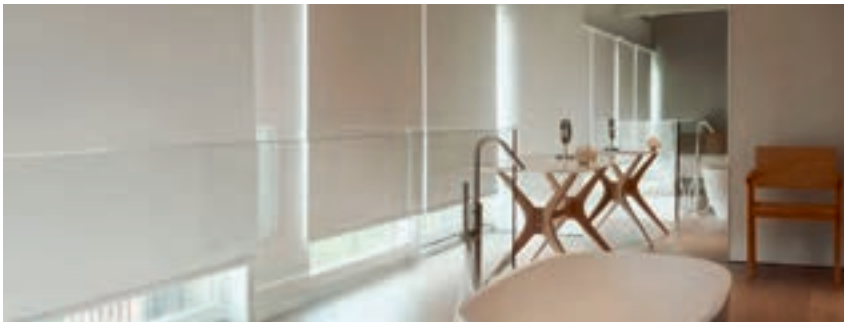

BLACKOUT

Our blackout fabric has a flocked backing which gives the back side of the fabric a soft textile appeal. With this fabric the room is completely darkened.

Flame retardant - 110 in. wide



WHITE
75002-04

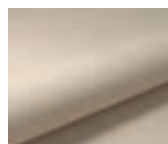

CREAM
75002-16

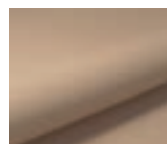

SAND
75002-17

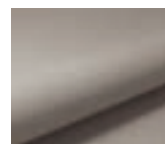

MIST
75002-18

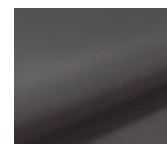

SLATE
75002-19



BLACK
75002-20



Scan for more information on the FOREST RBS Roman Blind System



25
White

RBS ROMAN BLIND SYSTEM

- The most durable and functional roman blind system on the market. RBS includes integrated Velcro tape so the fabric can be easily attached and removed.
- Aluminum, white, powder coated extrusion. Best suited for light to medium weight fabrics in contract or residential applications.
- Maximum weights:
1:4 gear up to 18 lbs.
1:2 gear up to 14 lbs.
1:1 gear up to 10 lbs.
- Includes child safety device and warning label. A motorized option is also available on pages 37-38.

ASSEMBLED PRICING

Includes headrail with integrated Velcro tape, cord roll supports, wall or ceiling brackets, counterweight (if requested), chain, child safety tension device & warning label. When ordering, please specify chain drop length, wall or ceiling mount, control side, and number of cord roll supports needed. Freight is additional.



RBS ROMAN BLIND SYSTEM	first 4 feet	ea. add'l inch
White	\$159.39	\$3.36



MOTOR CONTROL
P. 37-38

ROLLER SHADES & ROMANS

APOLLO BASIC | MERCURY DECORATIVE | ATLANTIS HEAVY DUTY | ROLLER SHADE FABRIC | **RBS** | RBS XL | BCS | ENDEAVOR

RBS	COMPONENT	PRICE	RBS	COMPONENT	PRICE
•	 41019-25 RBS Headrail with integrated Velcro tape 19' x 10 rails/bundle bundle = 190'	\$9.19/ft.	•	 49008-25 Shade Leveler	\$0.67 ea. \$0.57 ea. /box of 1000
•	 49010-25 RBS Cord Roll Support w/ quick lock, 12' drop	\$8.80 ea. \$7.99 ea. /box of 100	•	 39007-25 Velcro Tape 27 yds. per roll	\$34.21/roll
•	 Control Unit w/ End Cap & Retaining Ring heavy duty, self-braking 42311-25 1:4 gear to 18 lbs. 42312-25 1:2 gear to 14 lbs. 42310-25 1:1 gear to 10 lbs.	\$20.47 ea. \$17.06 ea. /box of 100	•	 49006-25 Fiberglass Spines, 19' 3/16" diameter	\$0.63/ft. \$0.55/ft. /bundle of 250
•	 41119-90 19' Rod aluminum 3/16" x 3/16"	\$3.25/ft. \$2.71/ft. /bundle of 5	•	 49014-25 Plastic Snap Ring	\$0.15 ea. \$0.12 ea. /box of 5000
•	 49005-25 Counterweight, 19' aluminum 1" x 1/8"	\$3.01/ft. \$2.39/ft. /bundle of 20	•	 49013-25 Plastic Ring Cord Guide	\$0.15 ea. \$0.12 ea. /box of 5000
•	 31116-25 Velcro Profile w/Hook Tape, 13.1'	\$5.72/ft. \$4.75/ft. /bundle of 20	•	 Endless Chain 25 white plastic or 90 nickel 49020-25, 90, 29" \$2.69 ea. 49021-25, 90, 39" \$3.13 ea. 49022-25, 90, 49" \$3.87 ea. 49023-25, 90, 59" \$4.30 ea. 49024-25, 90, 69" \$4.53 ea. 49025-25, 90, 79" \$4.66 ea. 49026-25, 90, 89" \$4.81 ea. 49027-25, 90, 99" \$5.22 ea.	
•	 43202-25 Swivel Wall Bracket	\$2.76 ea. \$2.30 ea. /box of 100	•	 76047-90 Metal Ball Chain Stopper	\$0.67 ea.
•	 43003-25 Swivel Ceiling Bracket	\$3.11 ea. \$2.59 ea. /box of 100	•	 79005-00 Clear Ball Chain Stopper	\$1.34 ea. \$1.12 ea. /box of 500
•	 43033-25 Klick Wall Bracket	\$3.11 ea. \$2.59 ea. /box of 100	•	 49501-00 Tension Device For child safety	\$10.32 ea. \$8.59 ea./box 250
•	 43034-25 Hidden Klick Multi Bracket	\$3.11 ea. \$2.59 ea. /box of 100			
•	 43004-25 Klick Ceiling Bracket	\$3.11 ea. \$2.59 ea. /box of 100			

BREAK PACK PRICING - Prices with this designation indicate a 20% up charge for broken pack quantities.
• Standard item in assembled sets.

ROMANS RBS CHAIN DRAW



Scan for more information on the FOREST RBS Motorized System



25
White

RBS MOTORIZED ROMAN BLIND SYSTEM

- The most durable and functional roman blind system on the market. RBS Motorized includes integrated Velcro tape so the fabric can be easily attached and removed.
- Aluminum, white, powder coated extrusion. Best suited for light weight fabrics in contract or residential applications.
- Maximum weight is 10 lbs with a maximum width of 84".
- The motor and lithium iOn battery each include a 1 year warranty.

ASSEMBLED PRICING

Includes headrail with integrated Velco tape, cord roll supports, brackets, counterweight (if requested), motor and remote or wall switch. When ordering, please specify motor side, wall or ceiling mount, and number of cord roll supports needed. Freight is additional.

RBS MOTORIZED ROMAN BLIND SYSTEM	first 4 feet	ea. add'l inch
Lithium iOn Battery Motor	\$960.33	\$3.37



NEW! OPERATE RBS BLINDS WITH BOND BRIDGE PRO!

52955-25
Bond Bridge Pro
\$379.00
No discounts on this item

ROLLER SHADES & ROMANS

APOLLO BASIC | MERCURY DECORATIVE | ATLANTIS HEAVY DUTY | ROLLER SHADE FABRIC | **RBS** | RBS XL | BCS | ENDEAVOR

RBS MOT	COMPONENT	PRICE	RBS MOT	COMPONENT	PRICE
•	 41019-25 RBS Headrail with integrated Velcro tape 19' x 10 rails/bundle bundle = 190'	\$9.19/ft.	•	 49008-00 Shade Leveler	\$0.67 ea. \$0.57 ea. /box of 1000
•	 49010-25 RBS Cord Roll Support w/ quick lock, 12' drop	\$8.80 ea. \$7.99 ea. /box of 100	•	 39007-25 Velcro Tape 27 yds. per roll	\$34.21/roll
•	 62913-25 RBS End Caps left & right	\$2.04/set of 2	•	 49006-25 Fiberglass Spines, 19' 3/16" diameter	\$0.63/ft. \$0.55/ft. /bundle of 250
•	 41119-90 19' Rod aluminum 3/16" x 3/16"	\$3.25/ft. \$2.71/ft. /bundle of 5	•	 49014-25 Plastic Snap Ring	\$0.15 ea. \$0.12 ea. /box of 5000
•	 49005-25 Counterweight, 19' aluminum 1" x 1/8"	\$3.01/ft. \$2.39/ft. /bundle of 20	•	 49013-25 Plastic Ring Cord Guide	\$0.15 ea. \$0.12 ea. /box of 5000
•	 43202-25 Swivel Wall Bracket	\$2.76 ea. \$2.30 ea. /box of 100	•	 62910-25 RBS Tubular Lithium Motor, 1-year warranty 24 V, includes plug	\$514.34 ea. 1/box
•	 43003-25 Swivel Ceiling Bracket	\$3.11 ea. \$2.59 ea. /box of 100	•	 62912-25 Lithium Battery & Adaptor includes USB charging cable	\$308.11 ea. 1/box
•	 43033-25 Klick Wall Bracket	\$3.11 ea. \$2.59 ea. /box of 100	•	 62911-25 Remote for Lithium Motor 15 channel w/ holder	\$85.11 ea. 1/box
•	 43034-25 Hidden Klick Multi Bracket	\$3.11 ea. \$2.59 ea. /box of 100	•	 52947-25 Wireless Connector One-way transmitter to control drapery by third party app or by home auto- mation. Use with Forest Shuttle & tubular motors.	\$268.91 ea. 1/box
•	 43004-25 Klick Ceiling Bracket	\$3.11 ea. \$2.59 ea. /box of 100	•	 52953-25 Smart Plug	\$122.44 ea. 1/box

BREAK PACK PRICING - Prices with this designation indicate a 20% up charge for broken pack quantities.

• Standard item in assembled sets.

ROMANS RBS MOTORIZED



Scan for more information on the FOREST RBS XL Roman Blind System



25
White

RBS XL ROMAN BLIND SYSTEM

- Aluminum, white, powder coated extrusion. Best suited for light to medium weight fabrics in contract or residential applications.
- Includes integrated Velcro tape so the fabric can be easily attached and removed.
- Maximum weight is a 1:4 gear which will pull up to 24 lbs.
- Includes child safety device and warning label.

ASSEMBLED PRICING

Includes headrail with integrated Velcro tape, cord roll supports, wall or ceiling brackets, counterweight (if requested), chain, child safety tension device and warning label. When ordering, please specify chain drop length, wall or ceiling mount, control side, and number of cord roll supports needed. Freight is additional.

RBS XL ROMAN BLIND SYSTEM	first 4 feet	ea. add'l inch
White	\$193.60	\$4.27

ROLLER SHADES & ROMANS

APOLLO BASIC | MERCURY DECORATIVE | ATLANTIS HEAVY DUTY | ROLLER SHADE FABRIC | RBS | **RBS XL** | BCS | ENDEAVOR

RBS XL	COMPONENT	PRICE	RBS XL	COMPONENT	PRICE
●	 <p>44019-25 RBS XL Headrail with integrated Velcro tape 19' x 10 rails/bundle bundle = 190'</p>	\$13.55/ft.	●	 <p>39007-25 Velcro Tape 27 yds. per roll</p>	\$34.21/roll
●	 <p>44003-25 RBS XL Cord Roll Support</p>	\$11.84 ea.  \$9.86 ea. /box of 100	●	 <p>49006-25 Fiberglass Spines, 19' 3/16" diameter</p>	\$0.63/ft.  \$0.55/ft. /bundle of 250
●	 <p>44311-25 RBS XL Control Unit w/ End Cap & Screw 1:4 gear to 24 lbs.</p>	\$28.46 ea.  \$23.72 ea. /box of 100	●	 <p>49014-25 Plastic Snap Ring</p>	\$0.15 ea.  \$0.12 ea. /box of 5000
●	 <p>41119-90 19' Rod aluminum 3/16" x 3/16"</p>	\$3.25/ft.  \$2.71/ft. /bundle of 5	●	 <p>49013-25 Plastic Ring Cord Guide</p>	\$0.15 ea.  \$0.12 ea. /box of 5000
●	 <p>49005-25 Counterweight, 19' aluminum 1" x 1/8"</p>	\$3.01/ft.  \$2.39/ft. /bundle of 20	●	 <p>Endless Chain 25 white plastic or 90 nickel</p> <p>49020-25, 90, 29" \$2.69 ea. 49021-25, 90, 39" \$3.13 ea. 49022-25, 90, 49" \$3.87 ea. 49023-25, 90, 59" \$4.30 ea. 49024-25, 90, 69" \$4.53 ea. 49025-25, 90, 79" \$4.66 ea. 49026-25, 90, 89" \$4.81 ea. 49027-25, 90, 99" \$5.22 ea.</p>	
●	 <p>31116-25 Velcro Profile w/Hook Tape, 13.1'</p>	\$5.72/ft.  \$4.75/ft. /bundle of 20	●	 <p>76047-90 Metal Ball Chain Stopper</p>	\$0.68 ea.
●	 <p>44004-90 RBS XL Ceiling Bracket nickel plated</p>	\$4.52 ea.  \$3.77 ea. /box of 100	●	 <p>79005-00 Clear Ball Chain Stopper</p>	\$1.34 ea.  \$1.12 ea. /box of 500
●	 <p>44033-90 RBS XL Wall Bracket nickel plated</p>	\$11.84 ea.  \$9.86 ea. /box of 100	●	 <p>49501-00 Tension Device For child safety</p>	\$10.32 ea.  \$8.59 ea./box 250
●	 <p>49008-25 Shade Leveler</p>	\$0.68 ea.  \$0.55 ea. /box of 1000			

 BREAK PACK PRICING  - Prices with this designation indicate a 20% up charge for broken pack quantities.

● Standard item in assembled sets.



Scan for more information on the FOREST BCS Blind Contract System



25 White

BCS BLIND CONTRACT SYSTEM

- A heavy duty motorized blind system best suited for medium to heavy weight draperies.
- Aluminum, white, powder coated extrusion.
- Maximum recommended weight is 45 lbs per shade using the AC motor and 8.75 lbs per cord roll. Maximum width is 120".
- Maximum recommended weight is 16 lbs. per shade using the Lithium iOn motor.
- Ultra quiet <44dB and easy to install.
- The Forest BCS AC tubular motor includes a 10 year warranty. The Lithium iOn tubular motor includes a 3 year warranty.

ASSEMBLED PRICING

Includes headrail, cord roll supports, brackets, counterweight (if requested), Velcro profile, motor and Diamond Sense remote, wall switch or EasyTouch remote. When ordering, please specify motor side, wall or ceiling mount, and number of cord roll supports needed. Freight is additional.

BCS BLIND CONTRACT SYSTEM	first 4 feet	ea. add'l foot
AC Motor	\$1,515.15	\$105.20
Lithium iOn Battery Motor	\$985.38	\$105.20











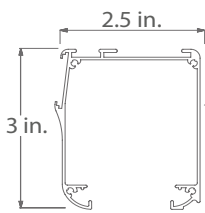

NEW! OPERATE BCS AC ROMAN BLINDS WITH BOND BRIDGE PRO!

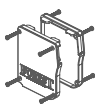
52955-25
Bond Bridge Pro
\$379.00
No discounts on this item

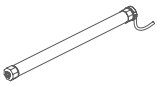
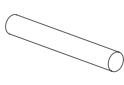
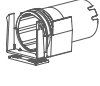
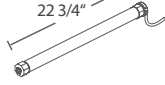
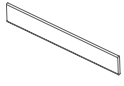
ROLLER SHADES & ROMANS

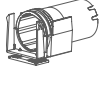
APOLLO BASIC | MERCURY DECORATIVE | ATLANTIS HEAVY DUTY | ROLLER SHADE FABRIC | RBS | RBS XLS | **BCS** | ENDEAVOR

BCS MOT	COMPONENT	PRICE	BCS MOT	COMPONENT	PRICE
●	 <p>61019-25 BCS Headrail white 19' aluminum extrusion</p>	\$15.21/ft.	●	 <p>49008-00 Shade Leveler</p>	\$0.68 ea. \$0.55 ea. /box of 1000
●	<p>61119-25 BCS 8-Angle Tube, 19'</p>	\$6.41/ft.	●	 <p>61125-25 BCS Velcro 7/8" x 4'</p>	\$19.98/ft. \$16.64/ft. /bundle of 25
●	 <p>62309-25 BCS End Caps left & right</p>	\$7.46 ea. \$6.23 ea. /box of 25	●	 <p>62901-25 Forest Tubular Motor built-in RF receiver, 35mm (1 3/8"), 110v, 6 Nm</p>	\$738.09 ea. 1/box
●	 <p>49006-25 Fiberglass Rod, 19'</p>	\$0.63/ft. \$0.55/ft. /bundle of 250	●	<p><i>COMING SOON!</i></p>  <p>68002-25 1.8 Nm Tubular Lithium iOn Motor, 3-year warranty Use with Forest controls</p>	\$208.32 ea. 1/box
●	 <p>49005-25 Counterweight, 19' aluminum 1" x 1/8"</p>	\$3.01/ft. \$2.39/ft. /bundle of 20	●	 <p>78003-25 Micro USB Charging Cable for 68000-25 and 68002-25</p>	\$26.41 ea
●	 <p>62000-25 BCS Cord Roll House & Drum contains 18' cord</p>	\$74.59 ea. \$62.17 ea. /box of 25	●	 <p>52931-25D white 59D black +10% Diamond Sense Remote RF, 15 channel w/ holder, Range 98'</p>	\$434.19 ea. 1/box
●	 <p>62200-25 BCS Tube Support place on open end of tube</p>	\$37.68 ea. \$31.40 ea. /box of 25	●	 <p>52933-25 white 59 black +10% Diamond Sense Wall Switch 2 channel Use with 68002-25</p>	\$213.73 ea. 1/box
●	 <p>63001-25 BCS Wall/Ceiling Easy Mount Bracket</p>	\$21.93 ea. \$19.30 ea. /box of 25	●	<p><i>COMING SOON!</i></p>  <p>52960-25 white 59 black +10% EasyTouch Remote RF, 6 channel Use with 68002-25</p>	\$303.93 ea. 1/box
●	 <p>62100-25 BCS Center Support 2" x 2.25"</p>	\$21.79 ea. \$18.27 ea. /box of 25	●	 <p>52947-25 Wireless Connector One-way transmitter to control drapery by third party app or by home automation. Use with Forest Shuttle & tubular motors.</p>	\$268.91 ea. 1/box

BREAK PACK PRICING - Prices with this designation indicate a 20% up charge for broken pack quantities.

● Standard item in assembled sets.



Scan for more information on
 FOREST ENDEAVOR Make Your Own
 Romans

ENDEAVOR BUILD YOUR OWN MOTORIZED ROMANS



- Our Endeavor system allows you to make your own Romans and use the same controls as your motorized drapery hardware.
- 1 1/2" / 38mm tube with a 1.8 Nm tubular motor. Recommended maximum weight per shade is 16 lbs.
- Motor includes crown and drive.
- Easy charging with a usb-c cable included in your kit.

















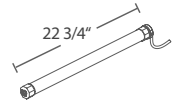

KIT PRICING

Includes 1 1/2" / 38mm tube, motor, drive, crown, end plug, brackets, clips (4 for the first 4 feet and 1 per each additional foot), charging cable and Forest Diamond Sense remote, wall switch or EasyTouch remote. Freight is additional.

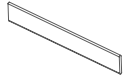
ENDEAVOR BUILD YOUR OWN	first 4 feet	ea. add'l foot
Lithium iOn Battery Motor	\$755.59	\$8.30

ROLLER SHADES & ROMANS

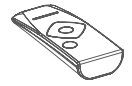
APOLLO BASIC | MERCURY DECORATIVE | ATLANTIS HEAVY DUTY | ROLLER SHADE FABRIC | RBS | RBS XLS | BCS | **ENDEAVOR**

ENDEAVOR	COMPONENT	PRICE	ENDEAVOR	COMPONENT	PRICE
•	 71119-90 1 1/2" / 38mm 19' Tube, aluminum	\$5.84/ft.	•	 49014-25 Plastic Snap Ring	\$0.15 ea.  \$0.12 ea. /box of 5000
•	 72309ED-25 End Plug	\$2.35 ea.	•	 49013-25 Plastic Ring Cord Guide	\$0.15 ea.  \$0.12 ea. /box of 5000
•	 72306-25 Multi-Purpose Bracket steel, 2 pcs	\$5.30/set 1 set/box	•	<i>COMING SOON!</i>  68002-25 1.8 Nm Tubular Lithium iOn Motor, 3-year warranty Use with Forest controls	\$208.32 ea. 1/box
•	 43036-90 Soft Shade Roller Clip	\$12.30/bag of 5	•	 78003-25 Micro USB Charging Cable for 68002-25	\$26.41 ea
•	 49006-25 Fiberglass Spines, 19' 3/16" diameter	\$0.63/ft.  \$0.55/ft. /bundle of 250	•	 52931-25D white 59D black +10% Diamond Sense Remote RF, 15 channel w/ holder, Range 98'.	\$434.19 ea. 1/box
•	 49005-25 Bottom weight, 19' aluminum 1" x 1/8"	\$3.01/ft.  \$2.39/ft. /bundle of 20	•	 52933-25 white 59 black +10% Diamond Sense Wall Switch 2 channel	\$213.73 ea. 1/box
•	 49004-25 Cord for Blind System	\$0.47/ft.	•	<i>COMING SOON!</i>  52960-25 white 59 black +10% EasyTouch Remote RF, 6 channel	\$303.93 ea. 1/box
•	 49008-00 Shade Leveler	\$0.68 ea.  \$0.55 ea. /box of 1000			

 BREAK PACK PRICING  - Prices with this designation indicate a 20% up charge for broken pack quantities.

• Standard item in assembled sets.

ROMANS ENDEAVOR BUILD YOUR OWN MOTORIZED ROMANS



DECORATIVE METAL

Our decorative metal collections offer the perfect combination of style and functionality. With a wide variety of designs from contemporary to traditional, and many stunning finishes, you are sure to find the right hardware for your room.

Fun Fact: Our collection names will tell you which country the hardware is from.

TAVIRA OUTDOOR POLE SETS AND TRAVERSING

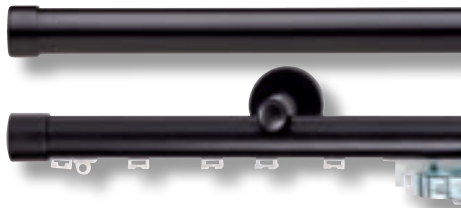

FARO SQUARE POLE SETS

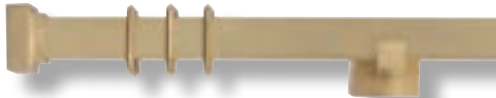

GLASGOW ACRYLIC POLE SETS

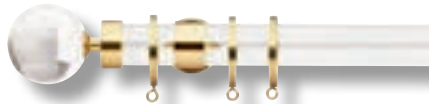

LISBON BRASS POLE SETS



AVEIRO STEEL POLE SETS



PORTO WROUGHT IRON POLE SETS



DRESDEN POLE SETS, TRAVERSING AND CORDED

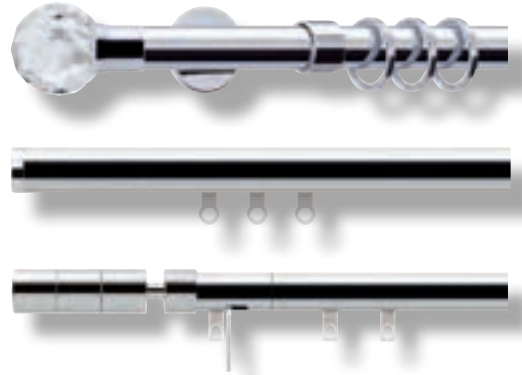

MOTORIZED
P. 105-108

DEVENTER DECO POLE SETS AND TRAVERSING



MOTORIZED
P. 109-110

FRANKFURT SQUARE RAIL



STUTT GART RECTANGLE RAIL



HANOVER RAIL



MOTORIZED
P. 103-104



Scan for more information on FOREST TAVIRA POLE SETS



Scan for more information on FOREST TAVIRA TRAVERSING



1 1/8" Tavira Outdoor Pole Set in 59 Black

TAVIRA OUTDOOR POLE SETS

1 1/8" Aluminum Powder Coated Pole Sets
Recommended weight is 4 lbs/ft. depending on application.

TAVIRA POLE SET FINISHES XX = finish color



25 White



59 Black



90 Grey



2031SMP-XX
1 1/8" Tavira Pole, 14'
Cannot be spliced
\$50.91/ft.

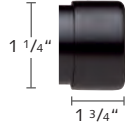

2130END-XX
Tavira End Cap
\$27.74 ea.



2230CIR-XX
Tavira Closed Bracket
\$72.60 ea.

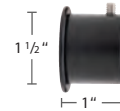

53412-XX
Inside Mount Bracket
\$110.78 ea.

METAL

TAVIRA OUTDOOR | FARO SQUARE | GLASGOW ACRYLIC | LISBON | AVEIRO | PORTO | DRESDEN POLES, TRAVERSING & CORDED
DEVENTER DECO POLES & TRAVERSING | FRANKFURT SQUARE RAIL | STUTTGART RECTANGLE RAIL | HANOVER TRAVERSING



1 1/8" Tavira Outdoor Traversing System in 89 Graphite

TAVIRA TRAVERSING FINISHES XX = finish color



25 White 81 Antique Bronze
89 Graphite 95 Taupe

TAVIRA TRAVERSING











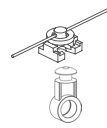

- 1 1/8" outdoor designer traversing system for one- or two-way pinch pleat or ripplefold drapery. The EasyFlex system on page 20 is recommended for ripplefold drapery.
- Wall or ceiling mount. Maximum length is 19' and this system cannot be spliced.
- Maximum weight is 4 lbs per foot depending on application.

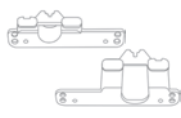
ASSEMBLED SETS

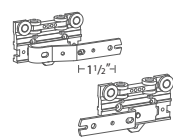
Include rail, end cap finial, carriers, end stop, masters, and wall or ceiling brackets. Indicate pinch pleat or ripplefold when ordering. Freight is additional.

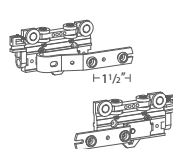
TAVIRA OUTDOOR TRAV	first 4 feet	ea. add'l foot
Single	\$681.48	\$84.40

TAVIRA	COMPONENT	PRICE
• 	51419-XX 1 1/8" Aluminum Rail 19', cannot splice	\$19.34/ft.
• 	53401-XX Single Wall Bracket 3" P	\$70.04 ea. 2/box
• 	53402-XX Extended Single Wall Bracket 4 3/4" P	\$92.22 ea. 2/box
• 	53412-XX Inside Mount Bracket	\$110.78 ea. 2/box
• 	53408-XX 25 white, 59 black Flush Ceiling Bracket Cannot use finials	\$25.56 ea.
• 	52430-XX End Cap Finial	\$48.47 ea. 10/box
• 	2116-25 Easywave Square Carrier, 80% use with 9039-25 Easyflex End Hook	\$1.35 ea.  \$1.12 ea. /box 1000
• 	9039-25 Easyflex End Hook	\$0.36 ea.  \$0.29 ea. /box 1000
• 	9036-00 Easyflex Tape 3" wide, 9/16" spacing	\$5.24/yd.  \$524.39 /roll 100 yds

TAVIRA	COMPONENT	PRICE
• 	Two Piece Connected Snap Carrier w/ Square Base, in plastic sleeve. Use 1 1/4" snap tape 2114-25, 59 black 60% fullness, 2 5/8" OC 2111-25, 59 black, 65 brown 80% fullness, 2 3/8" OC	\$1.47 ea.  \$1.23 ea. /roll of 500 Colors other than white +10%
• 	52004-25 Low Profile Ball Bearing	\$1.84 ea.  \$1.51 ea. /box of 1000
• 	B8809-23-00 Overlap R B8809-24-00 Underlap L 59 black + 10% Plastic Snap Master	\$15.46 ea.  \$12.86 ea. /box of 25
• 	52402-25 Overlap R 52404-25 Underlap L 59 black + 10% Standard Multi-Functional Master Stainless Steel arms	\$19.07 ea.  \$15.89 ea. /box of 100
• 	52402-25A Overlap R 52404-25A Underlap L 59A black + 10% Standard Multi-Functional Master w/ stainless steel snaps and arms	\$22.89 ea.  \$19.07 ea. /box of 100
• 	V799-2-00 End Stop	\$1.07 ea.  \$0.88 ea. /box of 100



Scan for more information on
FOREST FARO POLE SETS

FARO SQUARE COLLECTION

1 3/16" Square Pole Sets
Recommended weight is 4 lbs/ft. depending on application.

FARO FINISHES XX = finish color

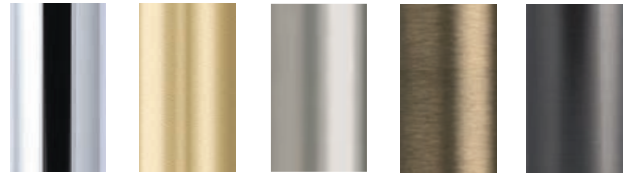

22	24	29	32	89
Polished Chrome	Satin Brass	Satin Nickel	Antique Bronze	Graphite



2030SQP-XX
1 3/16" Faro Square Rod
\$39.06/ft.



2230FRB-XX
Faro Recess Wall Bracket
\$45.14 ea.

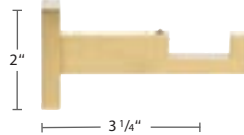

2230FWB-XX
Faro Wall Bracket
\$68.05 ea.

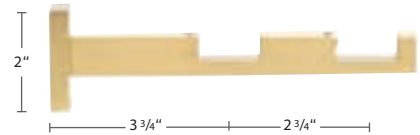

2230FDB-XX
Faro Double Wall Bracket
\$111.10 ea.

METAL

TAVIRA OUTDOOR | **FARO SQUARE** | GLASGOW ACRYLIC | LISBON | AVEIRO | PORTO | DRESDEN POLES, TRAVERSING & CORDED
DEVENTER DECO POLES & TRAVERSING | FRANKFURT SQUARE RAIL | STUTTGART RECTANGLE RAIL | HANOVER TRAVERSING

FARO SQUARE COLLECTION

Faro Square Pole, Square Rings and Square Finial in 24 Satin Brass

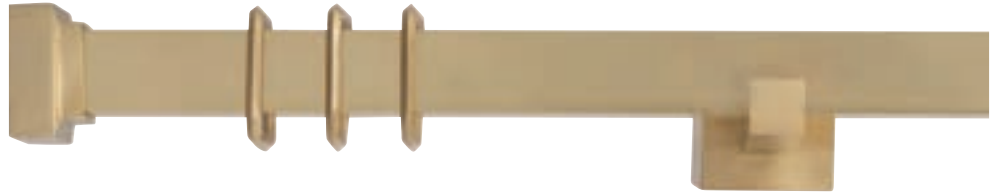

Faro Square Pole, Round Rings and Square Finial in 29 Satin Nickel



FARO COLLECTION FINIALS AND RINGS

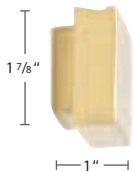

2130FSF-XX
Faro Square Finial
\$41.66 ea.

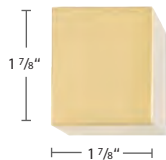

2130FCF-XX
Faro Cube Finial
\$51.39 ea.

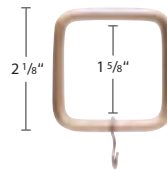

2030FSR-XX
Faro Square Ring
\$11.11 ea.

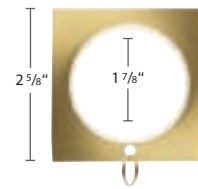

2030FKR-XX
Faro Round Ring
\$12.85 ea.



Scan for more information on
FOREST GLASGOW POLE SETS

GLASGOW ACRYLIC COLLECTION

1 3/8" & 1 3/4" Acrylic Pole Sets
Recommended weight is 4 lbs/ft. depending on application.

GLASGOW FINISHES XX = finish color



22
Polished
Chrome

23
Polished
Brass

29
Satin
Nickel

89
Graphite



3335AHP-00
1 3/8" Hollow Acrylic Pole, 10'
\$43.61/ft.

3345AHP-00
1 3/4" Hollow Acrylic Pole, 14' 4"
\$47.37/ft.

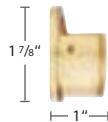

3035RWB-XX
1 3/8" Recess Wall Bracket
H: 1 7/8" P: 1"
\$82.33 ea.

3045RWB-XX
1 3/4" Recess Wall Bracket
H: 2 1/4" P: 1"
\$91.48 ea.

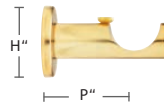

3035CYL-XX
1 3/8" Cylinder Bracket
H: 2" P: 2 1/2"
\$103.18 ea.

This bracket is not available
for 1 3/4" poles.

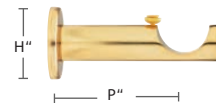

3035CYE-XX
1 3/8" Extended Cylinder Bracket
H: 2" P: 3 1/2"
\$123.82 ea.

3045CYE-XX
1 3/4" Extended Cylinder Bracket
H: 2 1/2" P: 4"
\$137.58 ea.

METAL

TAVIRA OUTDOOR | FARO SQUARE | **GLASGOW ACRYLIC** | LISBON | AVEIRO | PORTO | DRESDEN POLES, TRAVERSING & CORDED
DEVENTER DECO POLES & TRAVERSING | FRANKFURT SQUARE RAIL | STUTTGART RECTANGLE RAIL | HANOVER TRAVERSING

GLASGOW ACRYLIC COLLECTION

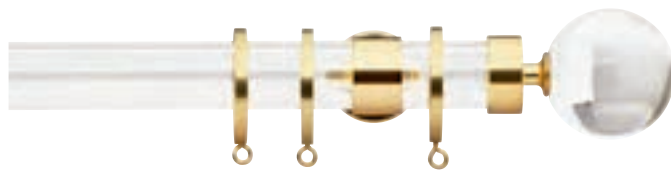

Clear Acrylic Glasgow Pole with Sphere Finial and Polished Brass Collar



Clear Acrylic Glasgow Pole, Pillbox Finial with Polished Chrome Collar, Rings & Bracket



Clear Acrylic Glasgow Pole, Cylinder Finial with Graphite Collar

GLASGOW COLLECTION COMPONENTS

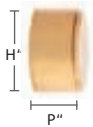

3035END-XX
1 3/8" Endcap Finial
H: 1 3/4" P: 1"
\$60.34 ea.

3045END-XX
1 3/4" Endcap Finial
H: 2" P: 1 1/8"
\$67.04 ea.

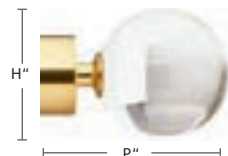

3035BAL-XX
1 3/8" Sphere Finial
H: 2 3/8" P: 3 7/8"
\$173.52 ea.

3045BAL-XX
1 3/4" Sphere Finial
H: 3" P: 4 3/4"
\$192.80 ea.

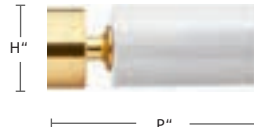

3035CIL-XX
1 3/8" Cylinder Finial
H: 1 3/4" P: 4 1/4"
\$173.51 ea.

3045CIL-XX
1 3/4" Cylinder Finial
H: 2 1/4" P: 5 1/8"
\$192.79 ea.

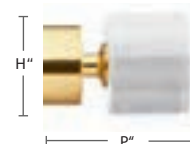

3035PIL-XX
1 3/8" Pillbox Finial
H: 2 1/4" P: 2 3/4"
\$136.00 ea.

3045PIL-XX
1 3/4" Pillbox Finial
H: 2 3/4" P: 3 1/2"
\$151.11 ea.

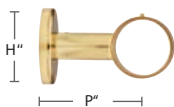

3035CCB-XX
1 3/8" Closed Bracket
H: 2" P: 2 1/2"
\$123.82 ea.

3045CCB-XX
1 3/4" Closed Bracket
H: 2" P: 3"
\$137.58 ea.

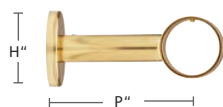

3035CWB-XX
1 3/8" Extended Closed Bracket
H: 2" P: 3 1/2"
\$135.06 ea.

3045CWB-XX
1 3/4" Extended Closed Bracket
H: 2" P: 4"
\$150.07 ea.

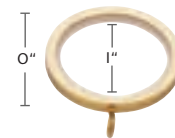

3035RIN-XX
1 3/8" Flat Ring w/ Plastic Insert
O: 2 1/2" I: 1 7/8"
\$12.95 ea.

3045RIN-XX
1 3/4" Flat Ring w/ Plastic Insert
O: 2 3/8" I: 2"
\$14.39 ea.



3035CON-XX
1 3/8" Joining Bracket
W: 2 1/2"
\$69.34 ea.

3045CON-XX
1 3/4" Joining Bracket
H: 3 1/2"
\$77.04 ea.



Scan for more information on
FOREST LISBON POLE SETS

LISBON COLLECTION

1 3/16" Brass Pole Sets with Finials or a French Return. Recommended weight is 4 lbs/ft. depending on application.

LISBON FINISHES XX = finish color



22
Polished Chrome



23
Polished Brass



24
Satin Brass

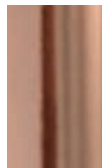

27
Rose Gold



29
Satin Nickel



32
Antique Bronze



36
Oil Rubbed
Bronze

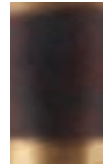

66
French Bronze



89
Graphite



2030SMP-XX
1 3/16" Brass Pole, 16'
\$46.28/ft.



2230FRE-22,23,24,29
French Return
Wall Bracket, P: 3 1/2"
\$85.45 ea.



2230EFR-22,23,24,29
Extended French Return
Wall Bracket, P: 6 1/2"
\$88.54 ea.



2230FRA-22,23,24,29
Adaptor to make a double
French return
Use with 2230EFR-XX
\$42.36 ea.

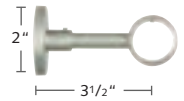

2230IRA-XX
Irati Closed Wall
Bracket & Support
for French Return
\$83.19 ea.

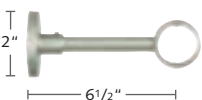

2230EIR-XX
Extended Irati Closed Wall
Bracket & Support for
Extended French Return
\$86.97 ea.

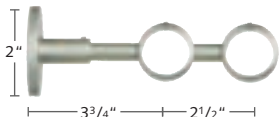

2230DIR-XX
Double Irati Closed Wall
Bracket & Support for Double
French Return
\$90.74 ea.



2230CIR-XX
Irati Closed Ceiling Bracket
\$72.60 ea.

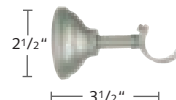

2230TOL-XX
Toledo Open Wall Bracket
\$70.02 ea.



2230OIM-XX
Open Inside Mount
Bracket
\$39.67 ea.

METAL

TAVIRA OUTDOOR | FARO SQUARE | GLASGOW ACRYLIC | **LISBON** | AVEIRO | PORTO | DRESDEN POLES, TRAVERSING & CORDED
DEVENTER DECO POLES & TRAVERSING | FRANKFURT SQUARE RAIL | STUTTGART RECTANGLE RAIL | HANOVER TRAVERSING



22 Polished Chrome Lisbon Pole with French Return



27 Rose Gold Lisbon Pole with Velate Finial



32 Antique Bronze Pole with Velate Finial

LISBON COLLECTION BY-PASS BRACKET & RING

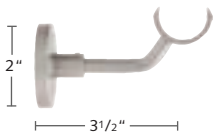

2230BPB-XX
By-Pass Bracket
\$44.79 ea.

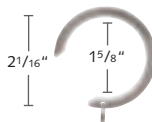

2230BPR-XX
By-Pass Ring, with plastic liner
\$6.11 ea.

LISBON COLLECTION FINIALS, BATON, SPLICE & HOLDBACK

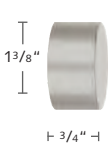

2130END-XX
End Cap Finial
\$27.74 ea.

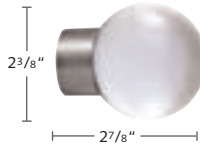

2130ACR-XX
Acrylic Ball Finial
\$87.70 ea.

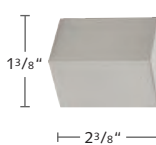

2130BLO-XX
Block Finial
\$69.58 ea.

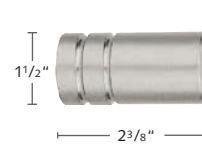

2130CIL-XX
Cilindro Finial
\$77.56 ea.

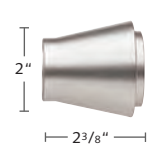

2130INC-XX
Inca Finial
\$77.91 ea.

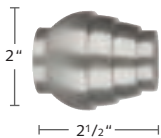

2130TIE-XX
Tier Finial
\$73.52 ea.

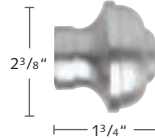

2130TOS-XX
Toscana Finial
\$58.06 ea.

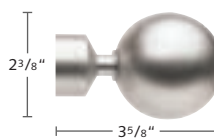

2130VEL-XX
Velate Finial
\$77.91 ea.

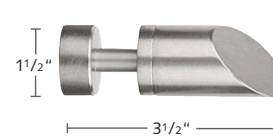

2130SLA-XX
Slant Finial
\$56.31 ea.

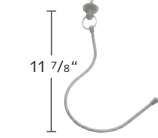

265SWING-XX
Swing Holdback
\$97.60 ea.

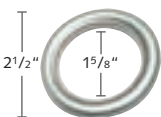

2330SHR-XX
Round Ring
with plastic liner
\$6.87 ea.

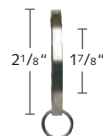

2330FRI-XX
Flat Ring
with plastic liner
\$12.97 ea.



2030SPL-23
Pole Splice
\$17.08 ea.



2130SWI-XX
Swivel Corner Connector
\$113.53 ea.



29MWAND-XX
Metal Control Baton 40"
\$101.40 ea.
See all batons p. 19



Scan for more information on
FOREST AVEIRO POLE SETS

AVEIRO COLLECTION

1 3/16" Steel Pole Sets with Finials or a French Return.
Recommended weight is 4 lbs/ft. depending on application.

AVEIRO FINISHES XX = finish color



16
Stainless Steel
19'



25
Shiny White
19'



59
Matte Black
16'



87
Bronze Brilliant
16'



88
Shiny Black
19'



2030SMP-XX
1 3/16" Steel Pole
\$46.28/ft.



2230FRE-59,88
French Return
Wall Bracket, P: 3 1/2"
\$85.45 ea.



2230EFR-59,88
Extended French Return
Wall Bracket, P: 6 1/2"
\$88.54 ea.



2230FRA-59,88
Adaptor to make a double
French return
Use with 2230EFR-59,88
\$42.36 ea.

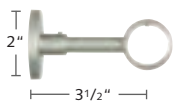

2230IRA-XX
Irati Closed Wall Bracket &
Support for French Return
\$83.19 ea.

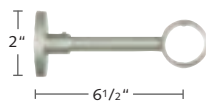

2230EIR-XX
Extended Irati Closed Wall Bracket &
Support for Extended French Return
\$86.97 ea.

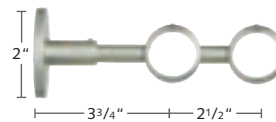

2230DIR-XX
Double Irati Closed Wall Bracket &
Support for Double French Return
\$90.74 ea.



2230CIR-XX
Irati Closed Ceiling Bracket
\$72.60 ea.

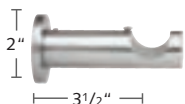

2230CYL-XX
Cylinder Wall Bracket
\$113.73 ea.

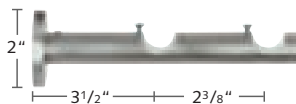

2230DCB-XX
Cylinder Double Wall Bracket
Not for use w/ grommets
\$185.94 ea.

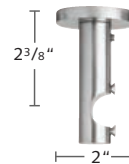

2230CYC-XX
Cylinder Ceiling Bracket
\$126.16 ea.



2230OIM-XX
Open Inside Mount
Bracket
\$39.67 ea.

METAL

TAVIRA OUTDOOR | FARO SQUARE | GLASGOW ACRYLIC | LISBON | **AVEIRO** | PORTO | DRESDEN POLES, TRAVERSING & CORDED
DEVENTER DECO POLES & TRAVERSING | FRANKFURT SQUARE RAIL | STUTTGART RECTANGLE RAIL | HANOVER TRAVERSING



87 Bronze Brilliant Aveiro Pole with French Return



16 Stainless Steel Aveiro Pole with Acrylic Ball Finial



16 Stainless Steel Aveiro Pole with Pop Chrystal Finial

AVEIRO COLLECTION BY-PASS BRACKET & RING

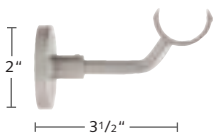

2230BPB-XX
By-Pass Bracket
\$44.79 ea.

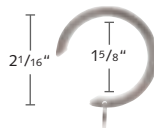

2230BPR-XX
By-Pass Ring, with plastic liner
\$6.11 ea.

AVEIRO COLLECTION FINIALS, BATON, SPLICE & HOLDBACK

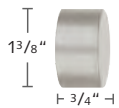

2130END-XX
End Cap Finial
\$27.74 ea.



2130ACR-XX
Acrylic Ball Finial
\$87.70 ea.

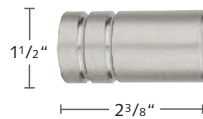

2130CIL-XX
Cilindro Finial
\$77.56 ea.

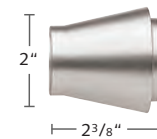

2130INC-XX
Inca Finial
\$77.91 ea.

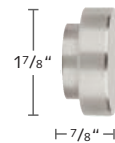

2130POP-XX
Pop Finial
\$67.19 ea.

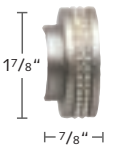

2130PWC-XX
Pop Crystal Finial
\$94.31 ea.

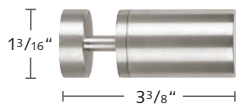

2130ROL-XX
Steel Rollenbild Finial
\$90.32 ea.

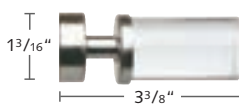

2130ROL-00 Stainless
2130ROL-XXC Clear Rollenbild Finial
\$104.90 ea.

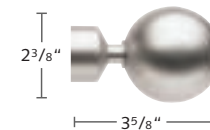

2130VEL-XX
Velate Finial
\$81.95 ea.

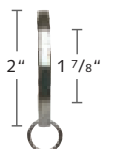

2330FRI-XX
Flat Ring
w/ plastic liner
\$12.97 ea.



2030SPL-23
Pole Splice
\$17.08 ea.

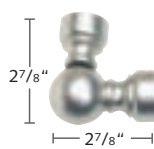

2130SWI-XX
Swivel Corner Connector
\$113.53 ea.



29AWAND-16
Round Baton 40"
\$106.65 ea.
See all batons p. 19



29SWAND-16
Square Baton 40"
\$112.30 ea.
See all batons p. 19



Scan for more information on
FOREST PORTO POLE SETS

PORTO 3/4" COLLECTION

3/4" Wrought Iron Pole Sets
Recommended weight is 4 lbs/ft. depending on application.

PORTO FINISHES XX = finish color



33
Black
Silver



35
Grey
Copper



37
Sand
Gold



38
Rust



40
Graphite
Rust



59
Black



220SIR-XX
3/4" Wrought Iron Pole, 13'
\$9.50/ft.



2220CEI-XX
3/4" Ceiling Bracket
\$33.20 ea.

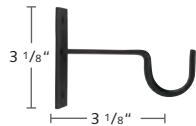

2220YOR-XX
3/4" York Single Open Bracket
\$34.90 ea.

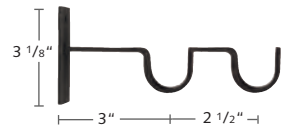

2220DYO-XX
3/4" York Double Open Bracket
\$46.38 ea.

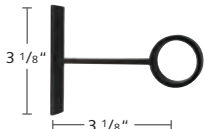

2220CYR-XX
3/4" York Wall/Ceiling Closed Bracket
\$38.31 ea.

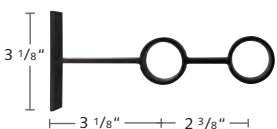

2220DCY-XX
3/4" York Double Wall Closed Bracket
\$51.62 ea.



2220ILA-XX
3/4" Inside Mount Bracket
\$20.16 ea.

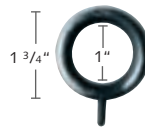

2320IRI-XX
3/4" Smooth Ring w/ Plastic Insert
\$5.45 ea.

METAL

TAVIRA OUTDOOR | FARO SQUARE | GLASGOW ACRYLIC | LISBON | AVEIRO | **PORTO** | DRESDEN POLES, TRAVERSING & CORDED
DEVENTER DECO POLES & TRAVERSING | FRANKFURT SQUARE RAIL | STUTTGART RECTANGLE RAIL | HANOVER TRAVERSING

37 Sand Gold Porto Pole with Caracola Finial



35 Grey Copper Porto Pole with Bola Finial



38 Rust Porto Pole with Berry Finial



40 Graphite Rust Porto Pole with Troia Finial

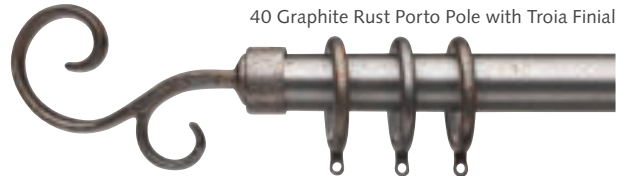

3/4" PORTO COLLECTION FINIALS, BATON & SPLICE



2120IEN-XX
3/4" End Cap Finial
\$14.30 ea.

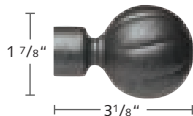

2120BOL-XX
3/4" Bola Finial
\$41.11 ea.

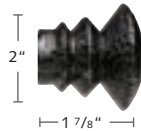

2120EVE-XX
3/4" Everest Finial
\$38.64 ea.

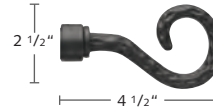

2120BER-XX
3/4" Berry Finial
\$25.98 ea.



2120CAR-XX
3/4" Caracola Finial
\$41.10 ea.

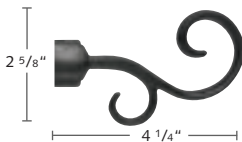

2120TRO-XX
3/4" Troia Finial
\$28.73 ea.



2120MAR-XX
3/4" Marte Finial
\$25.98 ea.



2020SPL-23
Pole Splice
\$17.08 ea.



2120SWI-XX
3/4" Swivel Corner
Connector
\$71.70 ea.



291WAND-XX
Iron Baton 40"
\$90.18 ea.
See all batons p. 19



Scan for more information on
FOREST PORTO POLE SETS

PORTO 1 3/16" COLLECTION

1 3/16" Wrought Iron Pole Sets
Recommended weight is 4 lbs/ft. depending on application.

PORTO FINISHES XX = finish color



33
Black
Silver



35
Grey
Copper



37
Sand
Gold



38
Rust



40
Graphite
Rust



59
Black



2030SIR-XX
1 3/16" Wrought Iron Pole, 13'
\$12.86/ft.



2230CEI-XX
1 3/16" Ceiling
Bracket
\$33.81 ea.

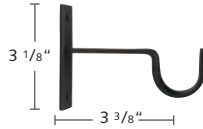

2230YOR-XX
1 3/16" York Single Open
Bracket
\$34.90 ea.

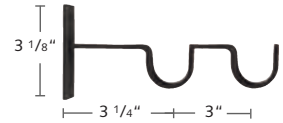

2230DYO-XX
1 3/16" York Double Open Bracket
\$46.51 ea.

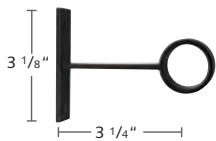

2230CYR-XX
1 3/16" York Single Closed
Bracket
\$38.40 ea.

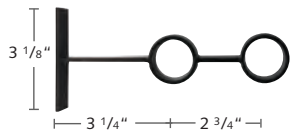

2230DCY-XX
1 3/16" York Double Closed Bracket
\$51.16 ea.

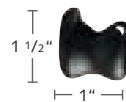

2230ILA-XX
1 3/16" Inside Mount
Bracket
\$21.72 ea.



2230FRT-59
1 3/16" French Return Bracket
P: 3 3/8"
\$43.10 ea.

METAL

TAVIRA OUTDOOR | FARO SQUARE | GLASGOW ACRYLIC | LISBON | AVEIRO | **PORTO** | DRESDEN POLES, TRAVERSING & CORDED DEVENTER DECO POLES & TRAVERSING | FRANKFURT SQUARE RAIL | STUTTGART RECTANGLE RAIL | HANOVER TRAVERSING

33 Black Silver Porto Pole with French Return Bracket



37 Sand Gold Porto Pole with Troia Finial and York Closed Bracket



35 Grey Copper Porto Pole with York Open Bracket and Caracola Finial



59 Black Porto Pole with Ball Finial and York Closed Bracket

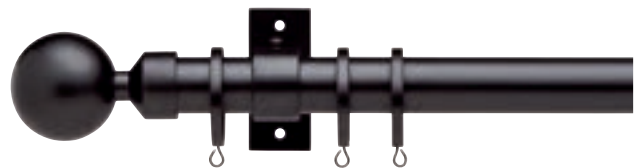

1 3/16" PORTO COLLECTION FINIALS & BATON

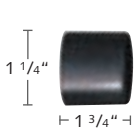

2130IEN-XX
1 3/16" End Cap Finial
\$16.28 ea.

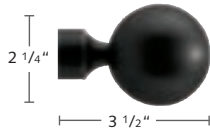

2130BAL-XX
1 3/16" Ball Finial
\$71.17 ea.

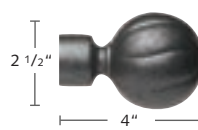

2130BOL-XX
1 3/16" Bola Finial
\$71.17 ea.

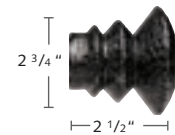

2130EVE-XX
1 3/16" Everest Finial
\$42.93 ea.

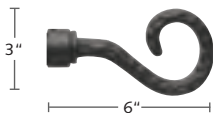

2130BER-XX
1 3/16" Berry Finial
\$28.85 ea.

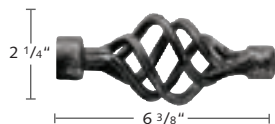

2130CAR-XX
1 3/16" Caracola Finial
\$74.32 ea.

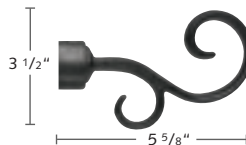

2130TRO-XX
1 3/16" Troia Finial
\$31.91 ea.



2130MAR-XX
1 3/16" Marte Finial
\$28.85 ea.

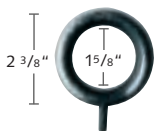

2330IRI-XX
1 3/16" Smooth Ring
w/ Plastic Insert
\$10.82 ea.

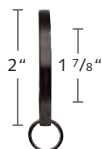

2330FRI-XX
1 3/16" Flat Ring
w/ Plastic Insert
\$12.97 ea.



2030SPL-23
Pole Splice
\$17.08 ea.



2130SWI-XX
1 3/16" Swivel Corner
Connector
\$113.53 ea.



291WAND-XX
Iron Control Baton
Length: 40"
\$90.18 ea.
See all batons p. 19



Scan for more information on
FOREST DRESDEN POLE SETS

DRESDEN COLLECTION

1 1/8" Brass Pole Sets with Finials or a French Return
Recommended weight is 4 lbs/ft. depending on application.

DRESDEN POLE SET FINISHES XX = finish color



22
Polished
Chrome

24
Satin
Brass

29
Satin
Nickel

59
Black

70
Bronze
Matte



B801-28-XX
1 1/8" Brass Pole, 16' 4"
\$33.67/ft.



B11950-28-XX
Single Wall or Ceiling Bracket
\$262.97 ea.



B11952-28-XX
Double Wall Bracket
\$364.11 ea.

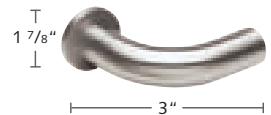

B11598-28-L-XX
B11598-28-R-XX
not avail. in 70 Bronze Matte
French Return, 3 1/8" P
\$206.37 ea.

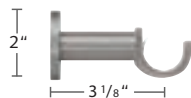

B400-80-XX
Support Bracket for French Return
\$202.18 ea.



B122028-XX
Inside Mount Bracket
\$113.26 ea.



B125930-XX
Flat Ring w/ Eyelet
Includes Plastic Insert
\$14.22 ea.

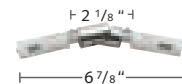

B122928-XX
Swivel Elbow
\$215.35 ea.



2030SPL-23
Splice
\$17.08 ea.

METAL

TAVIRA OUTDOOR | FARO SQUARE | GLASGOW ACRYLIC | LISBON | AVEIRO | PORTO | **DRESDEN POLES**, TRAVERSING & CORDED
DEVENTER DECO POLES & TRAVERSING | FRANKFURT SQUARE RAIL | STUTTGART RECTANGLE RAIL | HANOVER TRAVERSING



29 Satin Nickel Dresden Pole with French Return

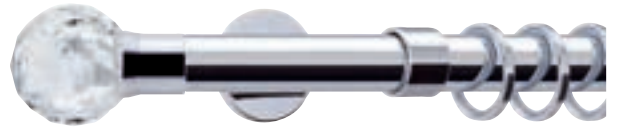

22 Polished Chrome Dresden Pole with Ardea Finial and Socket



24 Satin Brass Dresden Pole with Napoli Finial



29 Satin Nickel Dresden Pole with Alassio Finial

DRESDEN COLLECTION FINIALS

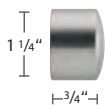

B124028-XX
End Cap Finial
\$56.65 ea.

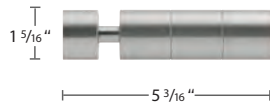

B690-XX
Pescara Finial
\$319.62 ea.

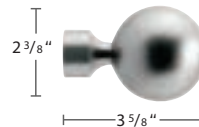

B3362-XX
Alassio Finial
\$323.64 ea.

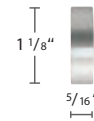

B124128-XX
Alea Finial
\$80.37 ea.

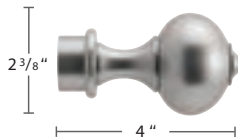

B650-XX
Verona Finial
\$438.48 ea.

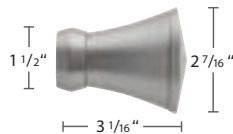

B610-XX
Napoli Finial
\$401.96 ea.

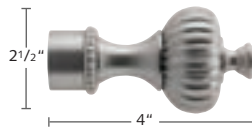

B660-22, 24, 29, 70
Roma Finial
\$567.08 ea.

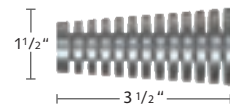

B3521-28-XX
Ischia Finial
\$277.76 ea.



B3389-100
Ardea Finial \$540.64 ea.
B3389/1-XX
Socket for Ardea Finial \$108.72 ea.



Scan for more information on
FOREST DRESDEN TRAVERSING



MOTORIZED
P. 105-108

DRESDEN TRAVERSING

- 1 1/8" heavy duty hand or baton draw h-rail system for one- or two-way pinch pleat or ripplefold drapery.
- Wall or ceiling mount. See bracket count below.

Up to 60" = 2 brackets	121-180" = 4 brackets
61-120" = 3 brackets	181-240" = 5 brackets
- Maximum weight is 4 lbs per foot depending on application.
- Bendable – Dresden Traversing can be curved and reversed curved using an 8" radius or continuous curve. An exact size template is required. See page 17-18 for more information.
- See Dresden Corded on pages 65-66 and Dresden Motorized on pages 105-108.



Dresden Traversing in 223 Oak with 29 Satin Nickel Alassio Finial

DRESDEN TRAVERSING FINISHES XX/XXX = finish color



22 Polished Chrome 24 Satin Brass 26 Brushed Gold 48 Matte White 29 Satin Nickel



59 Black 70 Bronze Matte 222 Beech poles only 223 Oak poles only 224 Walnut poles only

ASSEMBLED PRICING

Includes rail, end cap finial, carriers, end stop, masters, wall or ceiling brackets, and 36" white fiberglass baton (See all batons page 19). Indicate pinch pleat or ripplefold when ordering. Freight is additional.

DRESDEN TRAVERSING	first 4 feet	ea. add'l foot
Single	\$873.98	\$133.31
Double	\$1,747.91	\$266.39

DRESDEN TRAVERSING FINIALS

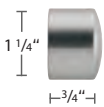

B124028-XX
End Cap Finial
\$56.65 ea.

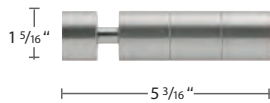

B690-XX
Pescara Finial
\$319.62 ea.

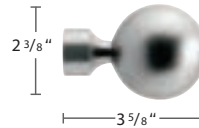

B3362-XX
Alassio Finial
\$323.64 ea.

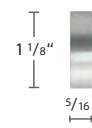

B124128-XX
Alea Finial
\$80.37 ea.

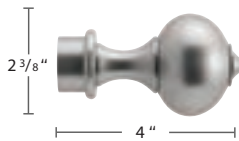

B650-XX
Verona Finial
\$438.48 ea.
not available in 26 or 48



B610-XX
Napoli Finial
\$401.96 ea.
not available in 48

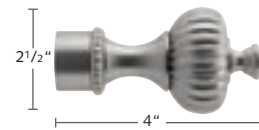

B660-22, 24, 29, 70
Roma Finial
\$567.08 ea.

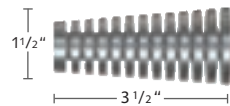

B3521-28-XX
Ischia Finial
\$277.76 ea.
not available in 26









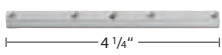
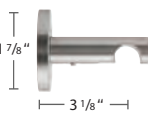
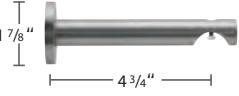
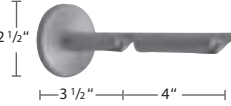
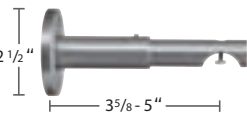
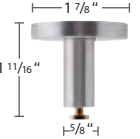
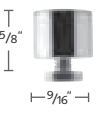
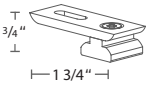
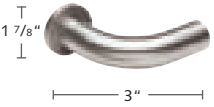





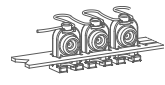

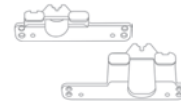

B3389-100
Ardea Finial \$540.64 ea.
B3389/1-XX
Socket for Ardea Finial \$108.72 ea.

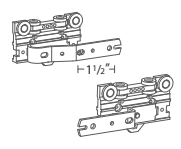
METAL

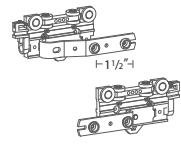
TAVIRA OUTDOOR | FARO SQUARE | GLASGOW ACRYLIC | LISBON | AVEIRO | PORTO | **DRESDEN TRAVERSING** & CORDED
DEVENTER DECO POLES & TRAVERSING | FRANKFURT SQUARE RAIL | STUTTGART RECTANGLE RAIL | HANOVER TRAVERSING

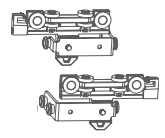
DRESDEN	COMPONENT	PRICE
	B808-28-XX 1 1/8" Aluminum H-Rail 19' 7"	\$34.51/ft. \$41.39/ft. foiled 222, 223, 224
	B899-4-00 1 1/8" & 1 9/16" Rail Connector	\$48.05 ea.
	B11670-XX Single Wall Bracket	\$178.02 ea.
	B11670-120-XX Extended Single Wall Bracket	\$189.07 ea.
	B11672-190-XX Double Wall Bracket	\$214.43 ea.
	B11670-V-XX Adjustable Wall Bracket	\$262.96 ea.
	B11873-50-XX Ceiling Bracket	\$110.40 ea.
	B11873-15-XX Ceiling Bracket 5/8" Projection	\$68.78 ea.
	53408-XX 22 chrome, 25 white, 24 gold, 29 satin nickel, 59 black Flush Ceiling Bracket Cannot use finials	\$25.56 ea.
	B11598-28-L-22, 24, 29, 59 B11598-28-R-22, 24, 29, 59 French Return, 3 1/8" P	\$206.37 ea.

 **BREAK PACK PRICING**  - Prices with this designation indicate a 20% up charge for broken pack quantities.

DRESDEN	COMPONENT	PRICE
	Wheeled Connected Snap Carriers on plastic strip 2207-25 60% fullness, 2 5/8" OC 2206-25 24 gold, 59 black, 65 brown, 90 silver 80% fullness, 2 3/8" OC 2205-25 100% fullness, 2 1/8" OC 2208-25 120% fullness, 1 7/8" OC	\$2.37 ea.  \$1.98 ea. /box of 500 Colors other than white +10%
	52002-25 24 gold, 59 black, 65 brown, 90 silver + 10% Slim Line Ball Bearing Carrier	\$0.82 ea.  \$0.67 ea. /box of 1000
	B8809-23-00 Overlap R B8809-24-00 Underlap L 59 black + 10% Plastic Snap Master	\$15.46 ea.  \$12.86 ea. /box of 25
	52502-25 Overlap R 52504-25 Underlap L 59 black + 10% Standard Multi-Functional Master Use stiffener w/ exposed baton or hooks w/ hidden baton	\$8.80 ea.  \$7.34 ea. /box of 100
	52502-25A Overlap R 52504-25A Underlap L 59A black + 10% Standard Multi-Functional Master w/ snaps	\$10.66 ea.  \$8.89 ea. /box of 100
	52411-25A Butt R 52412-25A Butt L 24A gold, 59A black, 65A brown, 90A silver Wheeled Butt Master w/snap adaptor Designed for hidden baton	\$37.74 ea.  \$31.44 ea. /box of 50 Colors other than white +10%
	B122928-XX Swivel Elbow not available in 26 or 48	\$215.35 ea.
	V799-2-00 End Stop	\$1.07 ea.  \$0.88 ea. /box of 100
	Fiberglass batons in 36", 48", 60", and 72" lengths and these colors. See all batons page 19.	

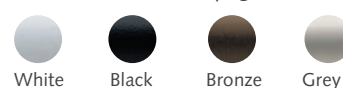

METAL TRAVERSING DRESDEN



Scan for more information on
FOREST DRESDEN 1 1/8" CORDED



MOTORIZED
P. 105-108

DRESDEN CORDED

- Light duty cord draw system for one- or two-way pinch pleat or ripplefold drapery.
- Wall or ceiling mount. See bracket count below.
Up to 60" = 2 brackets 121-180" = 4 brackets
61-120" = 3 brackets 181-240" = 5 brackets
- Maximum weight is 30 lbs. Designed for sheer fabric only.
- See Dresden Traversing on pages 63-64 and Dresden Motorized on pages 105-108.

ASSEMBLED PRICING

Includes rail, cord pulley in finished housing, carriers, masters, wall or ceiling brackets and child safety device. Indicate pinch pleat or ripplefold when ordering. Freight is additional.

DRESDEN CORDED	first 4 feet	ea. add'l foot
1 1/8" Single	\$1,131.07	\$140.89
1 1/8" Double	\$2,262.14	\$281.79



Dresden Corded in 29 Satin Nickel with finished end pulley

DRESDEN CORDED FINISHES XX/XXX = finish color

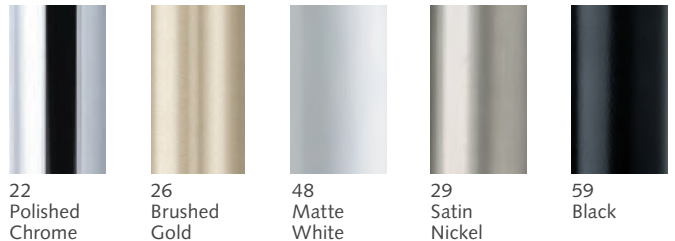

DRESDEN CORDED FINIALS

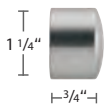

B124028-XX
End Cap Finial
\$56.65 ea.

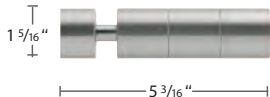

B690-XX
Pescara Finial
\$319.62 ea.

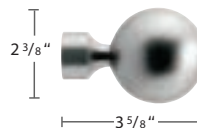

B3362-XX
Alassio Finial
\$323.64 ea.

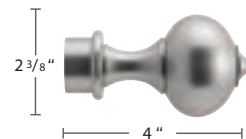

B650-XX
Verona Finial
\$438.48 ea.



B610-XX
Napoli Finial
\$401.96 ea.

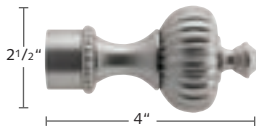



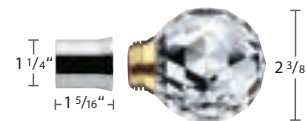







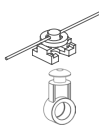







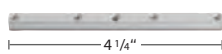
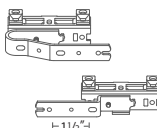

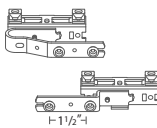

B660-22, 24, 29, 70
Roma Finial
\$567.08 ea.

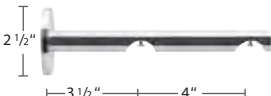

B3389-100
Ardea Finial \$540.64 ea.
B3389/1-XX
Socket for Ardea Finial \$108.72 ea.

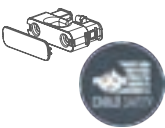
METAL

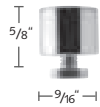
TAVIRA OUTDOOR | FARO SQUARE | GLASGOW ACRYLIC | LISBON | AVEIRO | PORTO | DRESDEN POLES, TRAVERSING & **CORDED**
DEVENTER DECO POLES & TRAVERSING | FRANKFURT SQUARE RAIL | STUTTGART RECTANGLE RAIL | HANOVER TRAVERSING

DRESDEN CORD	COMPONENT	PRICE	DRESDEN CORD	COMPONENT	PRICE
	 <p>B809-28-XX 1 1/8" Aluminum Rail for Cord Draw 19' 7"</p>	\$57.65/ft.		 <p>Two Piece Connected Snap Carrier w/ Square Base, in plastic sleeve. Use 1 1/4" snap tape 2114-25, 59 black 60% fullness, 2 5/8" OC 2111-25, 59 black, 65 brown, 90 silver 80% fullness, 2 3/8" OC 2112-25, 59 black 100% fullness, 2 1/8" OC 2115-25, 59 black 120% fullness, 1 7/8" OC</p>	\$1.47 ea.  \$1.23 ea. /roll of 500 Colors other than white +10%
	 <p>B11687-XX Cord Pulley in finished housing Finial optional</p>	\$109.25 ea.		 <p>52008-25 59 black +10% Slim Line Klick Carrier Allows drapery to hang and conceal track</p>	\$1.31 ea.  \$1.08 ea. /box of 250
	 <p>B11686-XX Return Pulley in finished housing Finial optional</p>	\$142.02 ea.		 <p>52009-25 Ball Bearing Carrier</p>	\$1.84 ea.  \$1.51 ea. /bundle of 250
	 <p>B899-4-00 Rail Connector</p>	\$48.05 ea.		 <p>52508-25 Overlap R 52509-25 Underlap L 59 black, 90 silver +10% Swivel Foot Multi-Functional Master</p>	\$15.51 ea.  \$12.95 ea. /box of 100
	 <p>B11670-XX Single Wall Bracket</p>	\$178.02 ea.		 <p>52508-25A Overlap R 52509-25A Underlap L 59 black, 90 silver +10% Swivel Foot Multi-Functional Master w/ snaps</p>	\$18.39 ea.  \$15.33 ea. /box of 100
	 <p>B11670-120-XX Extended Wall Bracket</p>	\$189.07 ea.		 <p>52510-25 59 black, 90 silver +10% Cord Connector</p>	\$2.86 ea.  \$2.38 ea. /box of 100
	 <p>B11672-190-XX Double Wall Bracket</p>	\$214.43 ea.		 <p>9004-25 3.2mm Cord 333.34 yds./roll</p>	\$2.46/yd.  \$820.28/roll
	 <p>B11670-V-XX Adjustable Wall Bracket</p>	\$262.96 ea.		 <p>49501-00 Tension Device For child safety</p>	\$10.32 ea.  \$8.59 ea. /box of 250
	 <p>B11873-50-XX Ceiling Bracket</p>	\$110.40 ea.			
	 <p>B11873-15-XX Ceiling Bracket 5/8" Projection</p>	\$68.78 ea.			
	 <p>53408-XX 22 chrome, 25 white, 29 satin nickel, 59 black Flush Ceiling Bracket Cannot use finials</p>	\$25.56 ea.			

 **BREAK PACK PRICING**  - Prices with this designation indicate a 20% up charge for broken pack quantities.



Scan for more information on
FOREST DEVENTER DECO POLE SETS

DEVENTER DECO COLLECTION

1 1/8" Aluminum Pole Sets with plastic inlay on pole and inside rings
Recommended weight is 4 lbs/ft. depending on application.

DEVENTER DECO FINISHES XX = finish color



29
Satin
Nickel



81
Antique
Bronze



89
Graphite



95
Taupe



51819-XX
1 1/8" Aluminum Pole, 19"
\$16.91/ft.

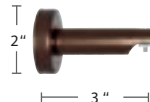

53401-XX
Single Bracket
3" P
\$70.04 ea. 2/box

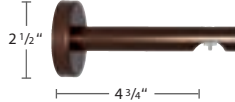

53402-XX
Extended Single Bracket
4 3/4" P
\$92.22 ea. 2/box



53406-XX
Double Bracket
6 1/4" P
Do not use with Ripplefold
\$132.36 ea. 2/box



53407-XX
Extended Double Bracket
7 3/4" P
Use with Ripplefold
\$148.24 ea. 2/box

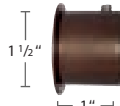

53412-XX
Inside Mount Bracket
\$110.78 ea. 2/box

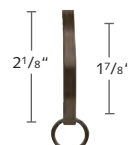

2330FRI-XX
Flat Ring
\$12.97 ea.



B899-3-00
Rail Connector
aluminum, 3"
\$22.39 ea.

METAL

TAVIRA OUTDOOR | FARO SQUARE | GLASGOW ACRYLIC | LISBON | AVEIRO | PORTO | DRESDEN POLES, TRAVERSING & CORDED
DEVENTER DECO POLES & TRAVERSING | FRANKFURT SQUARE RAIL | STUTTGART RECTANGLE RAIL | HANOVER TRAVERSING

Ultra quiet and smooth operation with a plastic inlay on the top of the pole and inside the rings.



81 Antique Bronze Deventer Deco Pole with Ball Finial



29 Satin Nickel Deventer Deco Pole with Notched Finial



89 Graphite Deventer Deco Pole with Notched Finial



95 Taupe Deventer Deco Pole with Notched Finial

DEVENTER COLLECTION FINIALS

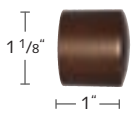

52430-XX
Deventer End Cap Finial
\$48.47 ea. 10/box

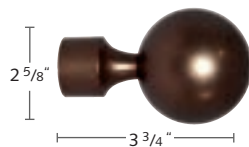

52431-XX
Deventer Ball Finial
\$101.60 ea. 10/box

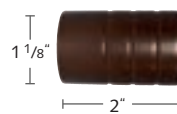

52432-XX
Deventer Notched Finial
\$55.97 ea. 10/box



Scan for more information on
FOREST DEVENTER CRS TRAVERSING



DEVENTER CRS® TRAVERSING

- 1 1/8" heavy duty baton draw h-rail system for one- or two-way pinch pleat or ripplefold drapery.
- Wall or ceiling mount. See bracket count below.

Up to 60" = 2 brackets	121-180" = 4 brackets
61-120" = 3 brackets	181-240" = 5 brackets
- Maximum weight is 4 lbs per foot depending on application.
- Bendable – Deventer CRS traversing can be curved and reversed curved using an 8" radius or continuous curve. An exact size template is required. See page 17-18 for more information.
- See Deventer MRS motorized on pages 109-110.

ASSEMBLED PRICING

Includes rail, end cap finial, carriers, end stop, masters, wall or ceiling brackets and 36" white fiberglass baton (See all batons page 19). Indicate pinch pleat or ripplefold when ordering. Freight is additional.

DEVENTER CRS	first 4 feet	ea. add'l foot
Single	\$695.11	\$86.09
Double	\$1,390.23	\$172.15



59 Black Deventer CRS Rail with Ball Finial in front & End Cap in back



81 Antique Bronze Deventer CRS Rail with End Cap Finial



29 Satin Nickel Deventer CRS Rail with Notched Finial

DEVENTER CRS FINISHES XX = finish color



24 Satin Brass



25 White



29 Satin Nickel



59 Black



81 Antique Bronze



89 Graphite

















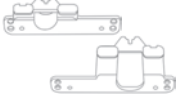

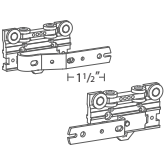

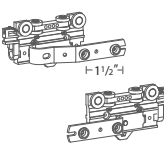

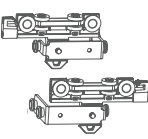
95 Taupe

METAL

TAVIRA OUTDOOR | FARO SQUARE | GLASGOW ACRYLIC | LISBON | AVEIRO | PORTO | DRESDEN POLES, TRAVERSING & CORDED
DEVENTER DECO POLES & TRAVERSING | FRANKFURT SQUARE RAIL | STUTTGART RECTANGLE RAIL | HANOVER TRAVERSING

DEVENTER	COMPONENT	PRICE
	51419-XX 1 1/8" Aluminum CRS Rail 19'	\$19.34/ft.
	53413-90 Rail Connector aluminum, 3"	\$23.76 ea. 25/box
	53401-XX Single Wall Bracket 3" P	\$70.04 ea. 2/box
	53402-XX Extended Single Wall Bracket 4 3/4" P	\$92.22 ea. 2/box
	53406-XX Double Wall Bracket 6 1/4" P Do not use w/ Ripplefold	\$132.36 ea. 2/box
	53407-XX Extended Double Wall Bracket 7 7/8" P Use w/ Ripplefold	\$148.24 ea. 2/box
	53412-XX Inside Mount Bracket	\$110.78 ea. 2/box
	53408-XX 22 chrome, 25 white, 24 gold, 29 satin nickel, 59 black Flush Ceiling Bracket Cannot use finials	\$25.56 ea.
	53403-XX Bracket Extension	\$91.03 ea. 10/box
	52430-XX End Cap Finial	\$48.47 ea. 10/box
	52431-XX Ball Finial	\$101.60 ea. 10/box
	52432-XX Not avail. in 25 white Notched Finial	\$55.97 ea. 10/box

DEVENTER	COMPONENT	PRICE
	2207-25 Wheeled Connected Snap Carriers on plastic strip 60% fullness, 2 5/8" OC 2206-25, 24, 59, 65, 90 80% fullness, 2 3/8" OC 2205-25 100% fullness, 2 1/8" OC 2208-25 120% fullness, 1 7/8" OC	\$2.37 ea.  \$1.98 ea. /box of 500 Colors other than white +10%
	52002-25 24 gold, 59 black, 65 brown, 90 silver + 10% Slim Line Ball Bearing Carrier	\$0.82 ea.  \$0.67 ea. /box of 1000
	52110-25 CRS Carrier UV-proof, synthetic material	\$0.55 ea.  \$0.47 ea. /box of 500
	B8809-23-00 Overlap R B8809-24-00 Underlap L 59 black + 10% Plastic Snap Master	\$15.46 ea.  \$12.86 ea. /box of 25
	52502-25 Overlap R 52504-25 Underlap L 59 black +10% Standard Multi-Functional Master Use stiffener w/ exposed baton or hooks w/ hidden baton	\$8.80 ea.  \$7.34 ea. /box of 100
	52502-25A Overlap R 52504-25A Underlap L 59A black +10% Standard Multi-Functional Master w/ snaps	\$10.66 ea.  \$8.89 ea. /box of 100
	52411-25A Butt R 52412-25A Butt L 24A gold, 59A black, 65A brown, 90A silver Wheeled Butt Master w/snap adaptor Designed for hidden baton	\$37.74 ea.  \$31.44 ea. /box of 50 Colors other than white +10%
	2551-25 Small Extension Arm	\$5.24 ea.  \$4.35 ea. /box of 50
	V799-2-00 End Stop	\$1.07 ea.  \$0.88 ea. /box of 100

 **BREAK PACK PRICING**  - Prices with this designation indicate a 20% up charge for broken pack quantities.



Scan for more information on
FOREST FRANKFURT SQUARE RAIL

FRANKFURT SQUARE RAIL

- 1" traversing square rail system for one- or two-way pinch pleat or ripplefold drapery.
- Wall or ceiling mount. See bracket count below.
 - Up to 60" = 2 brackets
 - 61-120" = 3 brackets
 - 121-180" = 4 brackets
 - 181-240" = 5 brackets
- Maximum weight is 4 lbs per foot depending on application.

ASSEMBLED PRICING

Includes rail, end cap finial, carriers, end stop, masters, wall or ceiling brackets and 36" white fiberglass baton (See all batons page 19). Indicate pinch pleat or ripplefold when ordering. Freight is additional.

FRANKFURT SQUARE RAIL	first 4 feet	ea. add'l foot
Single	\$982.39	\$196.22
Double	\$1,964.76	\$331.07



22 Polished Chrome Square Rail, Fina End Cap and Bracket



29 Satin Nickel Square Rail, Fina End Cap and Invisible Bracket



59 Black Square Rail with 22 Polished Chrome Fina End Cap and Bracket

FRANKFURT FINISHES XX = finish color

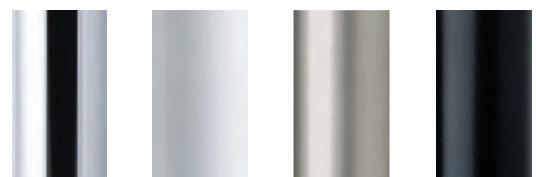

22
Polished
Chrome











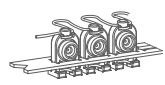

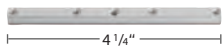
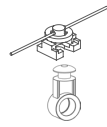
48
Matte
White

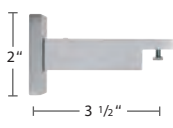
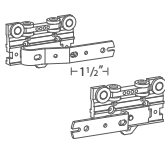

29
Satin
Nickel

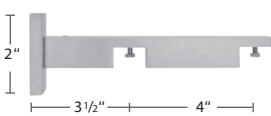
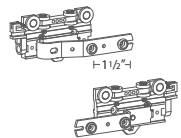
59
Black

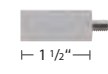
METAL

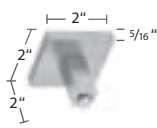
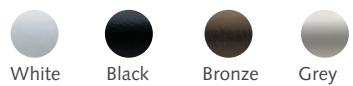
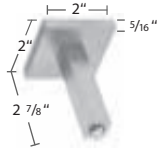
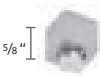
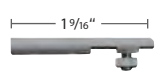
TAVIRA OUTDOOR | FARO SQUARE | GLASGOW ACRYLIC | LISBON | AVEIRO | PORTO | DRESDEN POLES, TRAVERSING & CORDED
DEVENTER DECO POLES & TRAVERSING | **FRANKFURT SQUARE RAIL** | STUTTGART RECTANGLE RAIL | HANOVER TRAVERSING

FRANKFURT	COMPONENT	PRICE	FRANKFURT	COMPONENT	PRICE
	B8082525-XX 1" Square Rail 19' 7"	\$63.55/ft.		Wheeled Connected Snap Carriers on plastic strip 2207-25 60% fullness, 2 5/8" OC 2206-25, 59 black, 90 silver 80% fullness, 2 3/8" OC 2205-25 100% fullness, 2 1/8" OC 2208-25 120% fullness, 1 7/8" OC	2.37 ea.  \$1.98 ea. /box of 500 Colors other than white +10%
	B899-4-00 1 1/8" & 1 9/16" Rail Connector	\$48.05 ea.		Two Piece Connected Snap Carrier w/ Square Base, in plastic sleeve. Use 1 1/4" snap tape 2114-25, 59 black 60% fullness, 2 5/8" OC 2111-25, 90 silver 80% fullness, 2 3/8" OC 2112-25, 59 black 100% fullness, 2 1/8" OC 2115-25, 59 black 120% fullness, 1 7/8" OC	\$1.47 ea.  \$1.23 ea. /roll of 500 Colors other than white +10%
	B1242525-XX Fina End Cap Finial	\$57.08 ea.		52002-25 59 black, 90 silver + 10% Slim Line Ball Bearing Carrier	\$0.82 ea.  \$0.67 ea. /box of 1000
	B11470-25-XX Wall Bracket	\$234.06 ea.		52502-25 Overlap R 52504-25 Underlap L 59 black + 10% Standard Multi-Functional Master Use stiffener w/ exposed baton or hooks w/ hidden baton	\$8.80 ea.  \$7.34 ea. /box of 100
	B11472-25-XX Double Wall Bracket	\$310.36 ea.		52502-25A Overlap R 52504-25A Underlap L 59A black + 10% Standard Multi-Functional Master w/ snaps	\$10.66 ea.  \$8.89 ea. /box of 100
	B11470-40-XX Bracket Extension for B11470-25-XX and B11472-25-XX	\$70.22 ea.		V799-2-00 End Stop	\$1.07 ea.  \$0.88 ea. /box of 100
	B11473-50-XX Ceiling Bracket/ Invisible Wall Bracket 2" Projection	\$123.11 ea.		Fiberglass batons in 36", 48", 60", and 72" lengths and these colors. See all batons page 19. White Black Bronze Grey	
	B11473-80-XX Ceiling Bracket/ Invisible Wall Bracket 2 7/8" Projection	\$127.72 ea.			
	B11473-15-XX Ceiling Bracket 5/8" Projection	\$73.09 ea.			
	B11592-00 Flush Ceiling Bracket	\$21.56 ea.			

 **BREAK PACK PRICING**  - Prices with this designation indicate a 20% up charge for broken pack quantities.



Scan for more information on
FOREST RECTANGLE RAIL

STUTTGART RECTANGLE RAIL

- Rectangle rail system for one- or two-way pinch pleat or ripplefold drapery.
- Wall or ceiling mount. See bracket count below.
 - Up to 60" = 2 brackets
 - 61-120" = 3 brackets
 - 121-180" = 4 brackets
 - 181-240" = 5 brackets
- Maximum weight is 4 lbs per foot depending on application.

ASSEMBLED PRICING

Includes rail, end cap finial, carriers, end stop, masters, wall or ceiling brackets and 36" white fiberglass baton (See all batons page 19). Indicate pinch pleat or ripplefold when ordering. Freight is additional.

RECTANGLE RAIL	first 4 feet	ea. add'l foot
Single	\$1,048.93	\$227.74
Double	\$2,097.84	\$455.46



22 Polished Chrome Rectangle Rail with Satin Nickel End Cap Finial



29 Satin Nickel Rectangle Rail with Satin Nickel End Cap Finial and Invisible Bracket

STUTTGART FINISHES XX = finish color

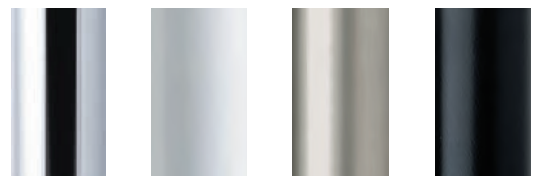

22 Polished Chrome











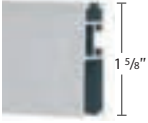
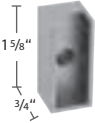
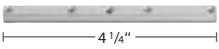
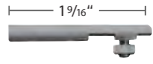
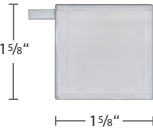
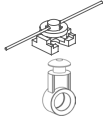



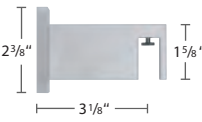

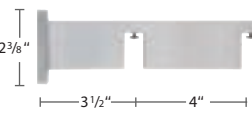
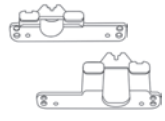



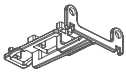

48 Matte White



29 Satin Nickel

59 Black

METAL

TAVIRA OUTDOOR | FARO SQUARE | GLASGOW ACRYLIC | LISBON | AVEIRO | PORTO | DRESDEN POLES, TRAVERSING & CORDED
DEVENTER DECO POLES & TRAVERSING | FRANKFURT SQUARE RAIL | **STUTTGART RECTANGLE RAIL** | HANOVER TRAVERSING

STUTTGART	COMPONENT	PRICE	STUTTGART	COMPONENT	PRICE
	B8084015-XX Rectangle Rail 19' 7"	\$51.41/ft.		B1224220-XX Inside Mount Bracket	\$53.12 ea.
	B899-4-00 Rail Connector	\$48.05 ea.		B11592-00 Flush Ceiling Bracket	\$21.56 ea.
	B11580-XX Square Finial	\$149.69 ea.		Two Piece Connected Snap Carrier w/ Square Base, in plastic sleeve. Use 1 1/4" snap tape	\$1.47 ea.  \$1.23 ea.  /roll of 500
	B1254015-XX End Cap Finial	\$84.96 ea.		2114-25, 59 black 60% fullness, 2 5/8" OC 2111-25, 59 black, 90 silver 80% fullness, 2 3/8" OC 2112-25, 59 black 100% fullness, 2 1/8" OC 2115-25, 59 black 120% fullness, 1 7/8" OC	Colors other than white +10%
	B11570-80-XX Single Wall Bracket	\$275.11 ea.			52002-25 59 black, 90 silver + 10% Slim Line Ball Bearing Carrier
	B11570-2-190-XX Double Wall Bracket	\$330.12 ea.		B8809-23-00 Overlap R B8809-24-00 Underlap L 59 black + 10% Plastic Snap Master	\$15.46 ea.  \$12.86 ea.  /box of 25
	B11473-50-XX Ceiling Bracket/ Invisible Wall Bracket 2" Projection	\$123.11 ea.		9040-25 Overlap R/L FES Master	\$6.22 ea.  \$5.18 ea.  /box of 25
	B11473-80-XX Ceiling Bracket/ Invisible Wall Bracket 2 7/8" Projection	\$127.72 ea.		V799-2-00 End Stop	\$1.07 ea.  \$0.88 ea.  /box of 100
	B11473-15-XX Ceiling Bracket 5/8" Projection	\$73.09 ea.	Fiberglass batons in 36", 48", 60", and 72" lengths and these colors. See all batons page 19.		
					
			White	Black	Bronze
					
			Grey		

 **BREAK PACK PRICING**  - Prices with this designation indicate a 20% up charge for broken pack quantities.



Scan for more information on FOREST HANOVER RAIL



MOTORIZED
P. 103-104

HANOVER RAIL

- Contemporary rail system for one- or two-way pinch pleat or ripplefold drapery.
- Wall or ceiling mount. See bracket count below.
 - Up to 60" = 2 brackets
 - 61-120" = 3 brackets
 - 121-180" = 4 brackets
 - 181-240" = 5 brackets
- Maximum weight is 4 lbs per foot depending on application.
- See Hanover Motorized on pages 103-104.

ASSEMBLED PRICING

Includes rail, end cap finial, carriers, end stop, masters, wall or ceiling brackets and 36" white fiberglass baton (See all batons page 19). Indicate pinch pleat or ripplefold when ordering. Freight is additional.

HANOVER RAIL	first 4 feet	ea. add'l foot
Single	\$1,307.68	\$281.62



22 Polished Chrome Hanover Rail with End Cap Finial



48 Matte White Hanover Rail with End Cap Finial



29 Satin Nickel Hanover Rail with End Cap Finial



59 Black Hanover Rail with End Cap Finial

HANOVER FINISHES XX = finish color



22 Polished Chrome

48 Matte White

29 Satin Nickel

59 Black

METAL

TAVIRA OUTDOOR | FARO SQUARE | GLASGOW ACRYLIC | LISBON | AVEIRO | PORTO | DRESDEN POLES, TRAVERSING & CORDED
DEVENTER DECO POLES & TRAVERSING | FRANKFURT SQUARE RAIL | STUTTGART RECTANGLE RAIL | **HANOVER TRAVERSING**

HANOVER	COMPONENT	PRICE	HANOVER	COMPONENT	PRICE
	B8223246-XX Hanover Profile 19' 7"	\$68.65/ft.		Two Piece Connected Snap Carrier w/ Square Base, in plastic sleeve. Use 1 1/4" snap tape 2114-25, 59 black 60% fullness, 2 5/8" OC 2111-25, 59 black, 90 silver 80% fullness, 2 3/8" OC 2112-25, 59 black 100% fullness, 2 1/8" OC 2115-25, 59 black 120% fullness, 1 7/8" OC	\$1.47 ea. \$1.23 ea. /roll of 500 Colors other than white +10%
	B1243246-XX Hanover End Cap Finial	\$70.99 ea.		52004-25 Low Profile Ball Bearing	\$1.84 ea. \$1.51 ea. /box of 1000
	B11260-90-XX Wall Bracket P = 3 3/4"	\$192.74 ea.		B8809-23-00 Overlap R B8809-24-00 Underlap L 59 black + 10% Plastic Snap Master	\$15.46 ea. \$12.86 ea. /box of 25
	B11260-130-XX Extended Wall Bracket P = 4 3/4"	\$217.17 ea.		9040-25 Overlap R/L FES Master	\$6.22 ea. \$5.18 ea. /box of 25
	B11592-00 Flush Ceiling Bracket	\$21.56 ea.		V799-2-00 End Stop	\$1.07 ea. \$0.88 ea. /box of 100
	B11473-50-XX Ceiling Bracket 2" Projection	\$123.11 ea.	Fiberglass batons in 36", 48", 60", and 72" lengths and these colors. See all batons page 19.		
	B11473-80-XX Ceiling Bracket 2 7/8" Projection	\$127.72 ea.		White	
	B11473-15-XX Ceiling Bracket 5/8" Projection	\$73.09 ea.		Black	
				Bronze	
				Grey	

BREAK PACK PRICING - Prices with this designation indicate a 20% up charge for broken pack quantities.

METAL TRAVERSING HANOVER RAIL



WOOD COLLECTIONS

Our wood drapery poles and accessories are made from only the finest solid woods such as ayous and ash. The richness of these woods and lovely finishes applied will add warmth and timeless beauty to any room.

THE
WORLD
BEHIND
YOUR
DRAPERIES

SEVILLE POLE SETS

VALENCIA POLE SETS

CORDOBA POLE SETS
AND HAND DRAW TRAVERSING



MOTORIZED
P. 111-112

LONDON POLE SETS
AND HAND DRAW TRAVERSING



MOTORIZED
P. 113-114





SEVILLE COLLECTION

1 3/8" Wood pole sets made from strong Ayous wood.
Recommended weight is 4 lbs./ft. depending on application.



Scan for more information on
FOREST SEVILLE POLE SETS

SEVILLE COLLECTION FINISHES XX = finish color

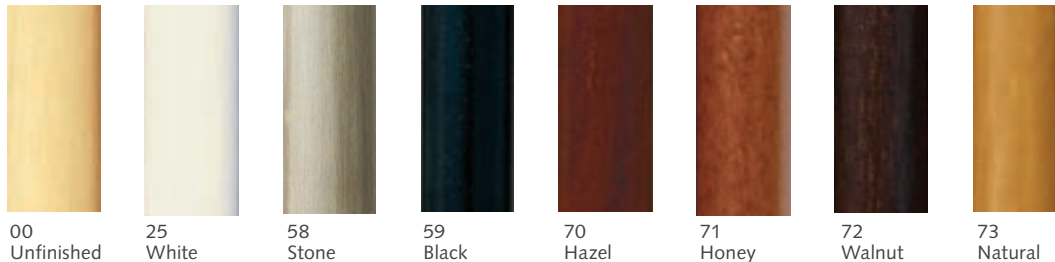

SEVILLE COLLECTION POLE & BRACKETS



1035SWO-XX
1 3/8" Smooth Wood Pole
Stock Length: 13'
\$9.54/ft.

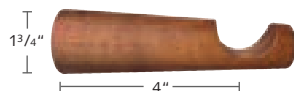

1235CYL-XX
Cylinder Bracket
\$17.86 ea.



1235CLA-XX
Classic Open Bracket
\$21.24 ea.



1235CEI-XX
Ceiling Bracket
\$17.94 ea.

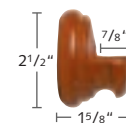

1235IMB-XX
Inside Mount Bracket
\$13.51 ea.

WOOD

1 3/8" SEVILLE POLE SETS | 1 3/4" VALENCIA POLE SETS | 2" CORDOBA POLE SETS & TRAVERSING | 1 3/8" + 1 3/4" LONDON POLE SETS & TRAVERSING

SEVILLE COLLECTION

59 Black Pole with End Cap Finial



70 Hazel Pole with Bola Finial



25 White Pole with Country Finial



SEVILLE COLLECTION FINIALS, RINGS, HOLDBACKS & BATONS

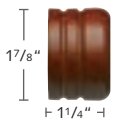

1135WEN-XX
End Cap Finial
\$8.54 ea.

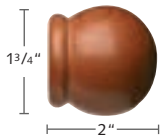

1135BOL-XX
Bola Finial
\$12.05 ea.

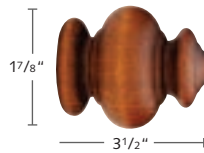

1135ODI-XX
Odiseia Finial
\$29.70 ea.

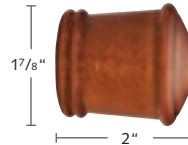

1135COR-XX
Corona Finial
\$15.11 ea.

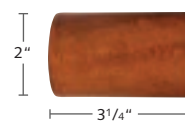

1135COU-XX
Country Finial
\$31.82 ea.

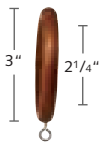

1335WRI-XX
1 3/8" Wood Ring
w/ Eyelet
\$2.95 ea.

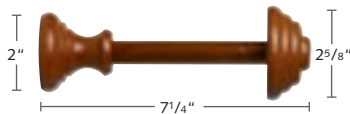

16WHOLD-XX
Wood Holdback
\$23.39 ea.



1504-00
Wood Screw
Connector
\$1.06 ea.



19WWAND-XX
40" Wood Baton
\$24.47 ea. unfinished
\$29.39 ea. finished

See all batons p. 19



19CWAND-XX
40" Modern Wood Baton
\$24.47 ea. unfinished
\$29.39 ea. finished

See all batons p. 19



VALENCIA COLLECTION

1 3/4" Valencia wood pole sets made from highly grained, strong ash wood. Recommended weight is 4 lbs./ft. depending on application.



Scan for more information on
FOREST VALENCIA POLE SETS

VALENCIA COLLECTION FINISHES XX = finish color

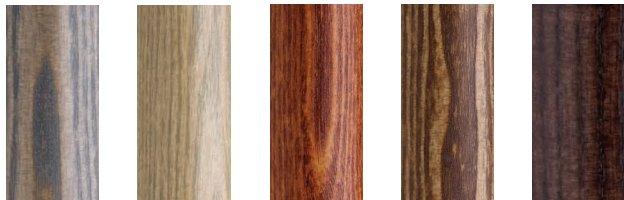

- 80 Driftwood
- 81 Weathered Oak
- 82 Redwood
- 83 Tiger Oak
- 84 Espresso

VALENCIA COLLECTION POLE, BRACKET & RING



1045SWO-XX
1 3/4" Smooth Wood Pole
Stock Length: 8'
\$45.65/ft.

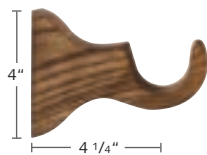

1245WBR-XX
Valencia Wall Bracket
\$48.58 ea.

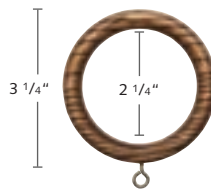

1345WRI-XX
Valencia Wood Ring
\$3.40 ea.

WOOD

1 3/8" SEVILLE POLE SETS | 1 3/4" VALENCIA POLE SETS | 2" CORDOBA POLE SETS & TRAVERSING | 1 3/8" + 1 3/4" LONDON POLE SETS & TRAVERSING

VALENCIA COLLECTION

Ash wood from France gives this collection a beautifully grained appearance.



80 Driftwood Smooth Pole with Castell Finial



81 Weathered Oak Smooth Pole with Granada Finial



82 Redwood Smooth Pole with Ringed Ball Finial



83 Tiger Oak Smooth Pole with Smooth Ball Finial



84 Espresso Smooth Pole with End Cap Finial

VALENCIA COLLECTION FINIALS

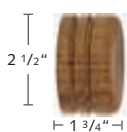

1145WEN-XX
End Cap Finial
\$13.59 ea.



1145SMO-XX
Smooth Ball Finial
\$29.56 ea.

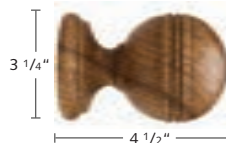

1145RIN-XX
Ringed Ball Finial
\$29.56 ea.



1145GRA-XX
Granada Finial
\$23.29 ea.

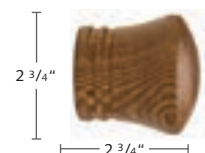

1145CAS-XX
Castell Finial
\$24.49 ea.



CORDOBA COLLECTION

2" Wood pole sets made from strong Ayous wood.
Recommended weight is 4 lbs./ft. depending on application.



Scan for more information on
FOREST CORDOBA POLE SETS



MOTORIZED
P. 111-112

CORDOBA COLLECTION FINISHES XX = finish color Not all components are stocked in Antiqued finishes. Please call for availability.



00 Unfinished



25 White



45 Leather Antiqued smooth poles only



58 Stone smooth poles only



59 Black



70 Hazel



71 Honey



72 Walnut



73 Natural

CORDOBA COLLECTION POLES & BRACKETS



1051SWO-XX
2" Smooth
Stock Length: 14'
\$21.36/ft. unfinished
\$24.20/ft. finished
\$36.26/ft. antiqued



1051RWO-XX
2" Reeded
Stock Length: 14'
\$23.70/ft. unfinished
\$30.86/ft. finished
Not available in 45, 58

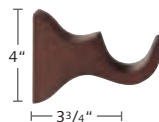

1251WBR-XX
Wood Bracket
\$39.34 ea. unfinished
\$48.58 ea. finished
\$71.11 ea. antiqued



1251EUR-XX
Euro Wood Bracket
\$25.14 ea. unfinished
\$32.81 ea. finished
\$50.45 ea. antiqued

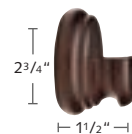

1251WIM-XX
Open Inside Mount Bracket
\$30.10 ea. unfinished
\$37.13 ea. finished
\$53.67 ea. antiqued

WOOD

1 3/8" SEVILLE POLE SETS | 1 3/4" VALENCIA POLE SETS | **2" CORDOBA POLE SETS & TRAVERSING** | 1 3/8" + 1 3/4" LONDON POLE SETS & TRAVERSING

CORDOBA COLLECTION

71 Honey Smooth Pole with Zenith Finial



58 Stone Smooth Pole with Ringed Ball Finial



72 Walnut Reeded Pole with Odiseia Finial

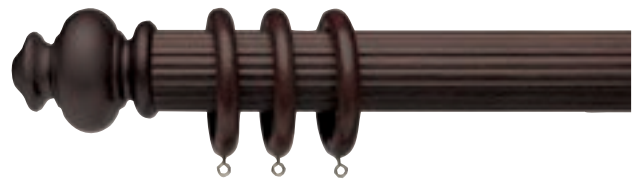

CORDOBA COLLECTION FINIALS, RING, HOLDBACKS & BATONS

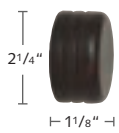

1151WEN-XX
End Cap Finial
\$13.98 ea. unfinished
\$17.47 ea. finished
\$23.07 ea. antiqued

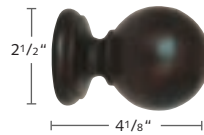

1151SMO-XX
Smooth Ball Finial
\$35.67 ea. unfinished
\$46.93 ea. finished
Not available in antiqued finishes



1151RIN-XX
Ringed Ball Finial
\$37.14 ea. unfinished
\$47.21 ea. finished
\$67.36 ea. antiqued

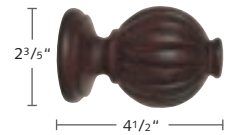

1151FLU-XX
Fluted Ball Finial
\$53.54 ea. unfinished
\$65.93 ea. finished
Not available in antiqued finishes

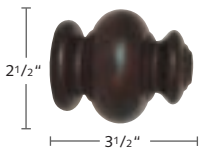

1151ODI-XX
Odiseia Finial
\$37.85 ea. unfinished
\$56.19 ea. finished
Not available in antiqued finishes

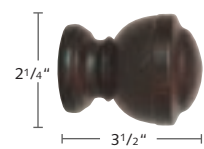

1151CAL-XX
Calice Finial
\$39.39 ea. unfinished
\$57.63 ea. finished
Not available in antiqued finishes

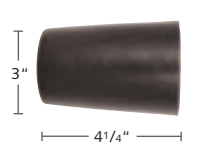

1151ZEN-XX
Zenith Finial
\$44.50 ea. unfinished
\$66.07 ea. finished
Not available in antiqued finishes

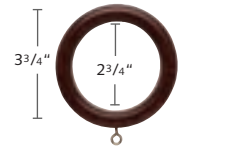

1351WRI-XX
2" Wood Ring w/ Eyelet
\$5.09 ea. unfinished
\$6.86 ea. finished
\$11.25 ea. antiqued



16WHOLD-XX
Wood Holdback
\$23.39 ea.



1504-00
Wood Screw Connector
\$1.06 ea.



19WWAND-XX
40" Wood Baton
\$24.47 ea. unfinished
\$29.39 ea. finished
\$54.72 ea. antiqued

See all batons p. 19



19CWAND-XX
40" Modern Wood Baton
\$24.47 ea. unfinished
\$29.39 ea. finished
\$54.72 ea. antiqued

See all batons p. 19



Scan for more information on FOREST WOOD TRAVERSING

CORDOBA TRAVERSING

- 2" heavy duty hand, baton or cord draw traversing system for one- or two-way pinch pleat or ripplefold drapery.
- Maximum weight is 4 lbs per foot depending on application.



MOTORIZED
P. 111-112



72 Walnut wood fascia over brown CS Track. Carriers are also available in colors.

ASSEMBLED PRICING

Includes wood pole fascia, assembled track, wall brackets (bracket cover optional and available for purchase separately), customer's choice of finials on page 84, c-ring where specified, and 36" white fiberglass baton (See all batons p. 19). Indicate pinch pleat or ripplefold when ordering. Freight is additional.

CORDOBA TRAVERSING	TRAVERSING first 4 feet	TRAVERSING ea. add'l ft.	C-RING first 4 feet	C-RING ea. add'l ft.
2" Cordoba Single Unfinished	\$471.67	\$38.05	\$686.16	\$67.55
2" Cordoba Single Finished	\$557.71	\$46.57	\$832.78	\$85.24
2" Cordoba Double Unfinished	\$530.61	\$51.50	\$898.76	\$80.97
2" Cordoba Double Finished	\$603.94	\$59.99	\$1,048.25	\$98.67

CORDOBA COLLECTION FINISHES

XX = finish color Not all components are stocked in Antiqued finishes. Please call for availability.



00 Unfinished



25 White



45 Leather Antiqued smooth poles only



58 Stone smooth poles only



59 Black



70 Hazel



71 Honey



72 Walnut



73 Natural

WOOD

1 3/8" SEVILLE POLE SETS | 1 3/4" VALENCIA POLE SETS | **2" CORDOBA POLE SETS & TRAVERSING** | 1 3/8" + 1 3/4" LONDON POLE SETS & TRAVERSING

CORDOBA TRAVERSING WOOD POLES



1051RSW-XX
2" CORDOBA
Routed Smooth
Stock Length: 14'



1051RRW-XX
2" CORDOBA
Routed Reeded
Stock Length: 14'

CORDOBA TRAVERSING WOOD TRACKS

Use CS Track in white, black, brown or grey with color coordinating components, or use cord draw CCS Track in white, brown or grey with color coordinating components. Use with pinch pleat or ripplefold draperies. See all carrier and master options on pages 5-6 for CS and page 8 for CCS.

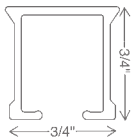
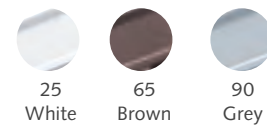
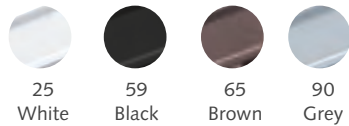

CS® CONTRACT SYSTEM
Aluminum extrusion, powder coated and lubricated.
Available in 25 white, 59 black, 65 brown and 90 grey.

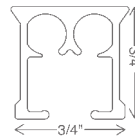

CCS® CONTRACT CORD SYSTEM
Aluminum extrusion, white, powder coated, lubricated. Available in 25 white, 65 brown and 90 grey. All corded systems include child safety tension device.

CORDOBA TRAVERSING WOOD BRACKETS



3280-25
59 black, 65 brown, 90 grey
3" Single Wall Bracket heavy duty
projection 2 1/2"
\$14.58 ea.
\$12.15 ea./box of 20

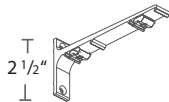

3281-25
59 black, 65 brown
6" Double Wall Bracket heavy duty
projection 1 1/2", 5 1/2"
\$20.90 ea.
\$17.41 ea./box of 15



32801-25
59 black, 90 grey + 10%
Wall Bracket Cover, optional
\$3.76 ea.
\$3.13 ea./box of 50

CORDOBA OPTIONAL C-RINGS

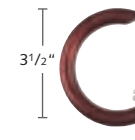

1352WRI-XX
C-Ring
Choose white, black or brown carrier
\$11.05 ea.



52007-25
59 black, 65 brown + 10%
C-Ring Carrier
\$0.60 ea.



52405-65 Overlap R
52406-65 Underlap L
90 grey + 10%
C-Ring Master Carrier
\$8.10 ea.

WOOD BATON OPTIONS See all batons p. 19



19WWAND-XX
40" Wood Baton
\$24.47 ea. unfinished
\$29.39 ea. finished
\$54.72 ea. antiqued



19CWAND-XX
40" Modern Wood Baton
\$24.47 ea. unfinished
\$29.39 ea. finished
\$54.72 ea. antiqued

Fiberglass batons come in 36", 48", 60", and 72" lengths and colors below. See all batons p. 19

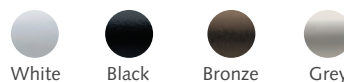



LONDON COLLECTION

1 3/8" + 1 3/4" Wood pole sets with wood and metal components. Recommended weight is 4 lbs./ft. depending on application.



Scan for more information on
FOREST LONDON POLE SETS



MOTORIZED
P. 113-114

LONDON COLLECTION FINISHES XX = finish color

WOOD POLE & COMPONENTS FINISHES



50
Oil Rubbed
Bronze



51
Antique
Gold



52
Burnished
Gold



53
Dark
Pewter



54
Distressed
Ivory

METAL COMPONENT FINISHES



22
Polished
Chrome



23
Polished
Brass



29
Satin
Nickel



89
Graphite

LONDON COLLECTION COMPONENTS



1035SWO-5X
1 3/8" Pole, 10'
\$48.65/ft.

1045SWO-5X
1 3/4" Pole, 10'
\$58.38/ft.

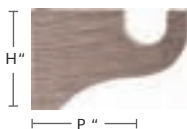

1235WBR-5X
1 3/8" Wall Bracket
H: 3 3/8" P: 3 3/4"
\$59.50 ea.

1245WBR-5X
1 3/4" Wall Bracket
H: 3 3/8" P: 3 3/4"
\$71.36 ea.

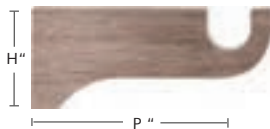

1235WBE-5X
1 3/8" Extended Wall Bracket
H: 3 3/8" P: 6 5/8"
\$70.31 ea.

1245WBE-5X
1 3/4" Extended Wall Bracket
H: 3 3/8" P: 6 3/4"
\$84.33 ea.



1235IMB-5X
1 3/8" Inside Mount Bracket
H: 2 1/2" P: 7/8"
\$67.56 ea.

1245IMB-5X
1 3/4" Inside Mount Bracket
H: 2 1/2" P: 7/8"
\$71.36 ea.

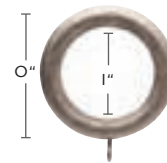

1335WRI-5X
1 3/8" Wood Ring
O: 2 1/2" I: 1 3/4"
\$14.06 ea.

1345WRI-5X
1 3/4" Wood Ring
O: 3" I: 2 1/4"
\$19.46 ea.

WOOD

1 3/8" SEVILLE POLE SETS | 1 3/4" VALENCIA POLE SETS | 2" CORDOBA POLE SETS & TRAVERSING | 1 3/8" + 1 3/4" LONDON POLE SETS & TRAVERSING



50 Oil Rubbed Bronze Pole with 23 Polished Brass French Return and Rings



53 Dark Pewter Pole with Bevel Finial and Rings



53 Dark Pewter Pole with 89 Graphite Cylinder Finial and Rings

LONDON COLLECTION COMPONENTS



1135MOD-5X
1 3/8" Modern End Cap
H: 1 5/8" P: 1"
\$64.87 ea.
1145MOD-5X
1 3/4" Modern End Cap
H: 2" P: 1"
\$77.85 ea.



1135BEV-5X
1 3/8" Bevel Finial
H: 2 5/8" P: 1 5/8"
\$86.49 ea.
1145BEV-5X
1 3/4" Bevel Finial
H: 2 1/4" P: 2"
\$103.79 ea.

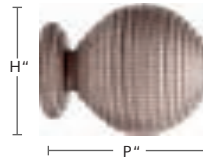

1135GRO-5X
1 3/8" Grooved Finial
H: 2 3/4" P: 3 5/8"
\$97.31 ea.
1145GRO-5X
1 3/4" Grooved Finial
H: 3 1/4" P: 3 3/4"
\$116.77 ea.

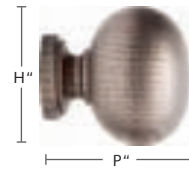

1135OVA-5X
1 3/8" Oval Ball Finial
H: 3 1/4" P: 3 1/4"
\$91.93 ea.
1145OVA-5X
1 3/4" Oval Ball Finial
H: 3 1/2" P: 3 3/8"
\$110.28 ea.

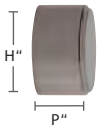

3035END-XX
1 3/8" End Cap Finial
H: 1 3/4" P: 1"
\$60.34 ea.
3045END-XX
1 3/4" End Cap Finial
H: 2" P: 1 1/8"
\$67.04 ea.

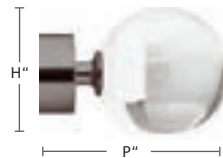

3035BAL-XX
1 3/8" Sphere Finial
H: 2 3/8" P: 3 7/8"
\$173.52 ea.
3045BAL-XX
1 3/4" Sphere Finial
H: 3" P: 4 3/4"
\$192.80 ea.

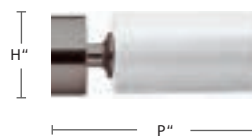

3035CIL-XX
1 3/8" Cylinder Finial
H: 1 3/4" P: 4 1/4"
\$173.51 ea.
3045CIL-XX
1 3/4" Cylinder Finial
H: 2 1/4" P: 5 1/8"
\$192.79 ea.

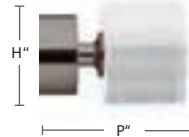

3035PIL-XX
1 3/8" Pilbox Finial
H: 2 1/4" P: 2 3/4"
\$136.00 ea.
3045PIL-XX
1 3/4" Pilbox Finial
H: 2 3/4" P: 3 1/2"
\$151.11 ea.



1135FRT-XX
1 3/8" French Return
H: 2 1/2" P: 4 1/2"
\$172.99 ea.



3035RWB-XX
1 3/8" Recess Wall Bracket
H: 1 7/8" P: 1"
\$82.33 ea.
3045RWB-XX
1 3/4" Recess Wall Bracket
H: 2 1/4" P: 1"
\$91.48 ea.

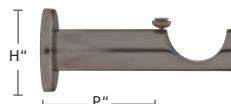

3035CYE-XX
1 3/8" Extended Cylinder Bracket
H: 2" P: 3 1/2"
(see P: 2 1/2" on p. 51)
\$123.82 ea.
3045CYE-XX
1 3/4" Extended Cylinder Bracket
H: 2 1/2" P: 4"
\$137.58 ea.



3035CWB-XX
1 3/8" Extended Closed Bracket
H: 2" P: 3 1/2"
(see P: 2 1/2" on p. 52)
\$135.06 ea.
3045CWB-XX
1 3/4" Extended Closed Bracket
H: 2" P: 4"
(see P: 3" on p. 52)
\$150.07 ea.

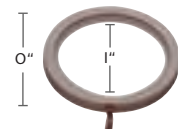

3035RIN-XX
1 3/8" Flat Ring w/ Plastic Insert
O: 2 1/2" I: 1 7/8"
\$12.95 ea.
3045RIN-XX
1 3/4" Flat Ring w/ Plastic Insert
O: 2 3/8" I: 2"
\$14.39 ea.



LONDON TRAVERSING

1 3/8" + 1 3/4" baton draw traversing system for one- or two-way pinch pleat or ripplefold drapery. Maximum weight is 4 lbs per foot depending on application.



Scan for more information on
FOREST LONDON TRAVERSING



MOTORIZED
P. 113-114

ASSEMBLED PRICING

Includes wood pole fascia, assembled track, wall brackets (bracket cover optional and available for purchase separately), end cap finial (see all finials on page 88), and 36" white fiberglass baton (see all batons p. 19). Indicate pinch pleat or ripplefold when ordering. Freight is additional.

LONDON TRAVERSING	first 4 feet	ea. add'l ft.
1 3/8" London Single Set	\$673.67	\$112.05
1 3/8" London Double Set	\$791.89	\$124.93
1 3/4" London Single Set	\$734.21	\$118.38
1 3/4" London Double Set	\$848.77	\$132.96

LONDON COLLECTION FINISHES XX = finish color

WOOD POLE & COMPONENTS FINISHES



50
Oil Rubbed
Bronze



51
Antique
Gold



52
Burnished
Gold



53
Dark
Pewter



54
Distressed
Ivory

METAL COMPONENT FINISHES



22
Polished
Chrome



23
Polished
Brass



29
Satin
Nickel



89
Graphite

WOOD

1 3/8" SEVILLE POLE SETS | 1 3/4" VALENCIA POLE SETS | 2" CORDOBA POLE SETS & TRAVERSING | **1 3/8" + 1 3/4" LONDON POLE SETS & TRAVERSING**



50 Oil Rubbed Bronze Pole with 23 Polished Brass End Cap



54 Distressed Ivory with Bevel Finial



52 Burnished Brass with 23 Polished Brass Cylinder Finial

1 3/8" LONDON TRAVERSING



1035RSW-5X
1 3/8" Routed Pole, 10'

Use KS Track in white, black, brown or grey with color coordinating components. Use with pinch pleat or ripplefold draperies. See all carrier and master options on pages 11-12.

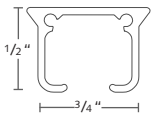
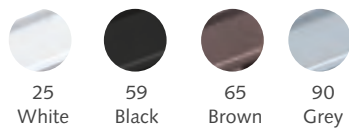

KS® KLICK SYSTEM
Aluminum extrusion, powder coated and lubricated. Available in 25 white, 59 black, 65 brown and 90 grey.

1 3/4" LONDON TRAVERSING



1045RSW-5X
1 3/4" Routed Pole, 10'

Use CS Track in white, black, brown or grey with color coordinating components. Use with pinch pleat or ripplefold draperies. See all carrier and master options on pages 3-6.

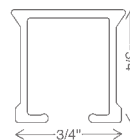
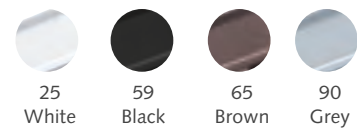

CS® CONTRACT SYSTEM
Aluminum extrusion, powder coated and lubricated. Available in 25 white, 59 black, 65 brown and 90 grey.

BRACKETS FOR LONDON TRAVERSING

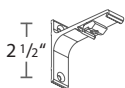

3280-25
59 black, 65 brown, 90 grey + 10%
3" Single Wall Bracket heavy duty projection 2 1/2"
\$14.58 ea. \$12.15 ea./box of 20

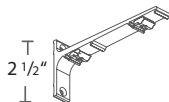

3281-25
59 black, 65 brown +10%
6" Double Wall Bracket heavy duty projection 1 1/2", 5 1/2"
\$20.90 ea. \$17.41 ea./box of 15



32801-25
59 black, 90 grey + 10%
Wall Bracket Cover, optional
\$3.76 ea. \$3.13 ea./box of 50

BATON OPTIONS See all batons p. 19

Fiberglass batons come in 36", 48", 60", and 72" lengths and colors below. See all batons p. 19





MOTORIZED SYSTEMS

Our wide range of control options make finding a fit for your room easy; controlling the drapery by hand, remote, or through the building automation system. When controlling motorized drapery with your smart phone or tablet, you can create and schedule customized room scenes that allow your drapes to operate on their own throughout the day.

THE
WORLD
BEHIND
YOUR
DRAPERIES



FMS®



RMS



DSXL LED



HANOVER



DRESDEN



DEVENTER MRS®



CORDOBA



LONDON

DRAPERY MOTORIZATION

SHUTTLE MOTORS | CONTROLS ROADMAP | FMS | RMS | DSXL LED | HANOVER | DRESDEN | DEVENTER MRS | CORDOBA | LONDON



DRAPERY MOTORIZATION SHUTTLE MOTOR SPECIFICATIONS

SHUTTLE® HD (M)

SHUTTLE® ECO (S)



SPECIFICATIONS

FEATURES

VOLTAGE SHUTTLE
RECEIVER
POWER SUPPLY
MAX POWER
TORQUE
TRAVEL SPEED
NOISE LEVEL
MAXIMUM WEIGHT
DIMENSIONS
CERTIFICATIONS/MARKINGS
COLOR OPTIONS

24V DC
Internal, optional
External, 100-240V AC - 1.5A,
50-60Hz; Output 24V DC - 2.7A
65W
1.5 Nm
5.5" per second standard
7" per second maximum
< 40 dB(A)
160 lbs per motor
120 lbs per motor - curved track
2.76" x 1.97" x 9.5"
CE/FCC/DOE
White / Black

24V DC
Internal
External, 100-240V AC - 0.8A,
50-60Hz; Output 24V DC - 2.5A
40W
1.0 Nm
5.5" per second standard
7" per second maximum
< 40 dB(A)
100 lbs per motor
90 lbs per motor - curved track
2.76" x 1.97" x 7.5"
CE/FCC/DOE
White

TOUCH CONTROL TECHNOLOGY
INTEGRATED EMERGENCY CONTROL
RF COMMUNICATION STANDARD
Z-WAVE COMMUNICATION
AUTOMATION SYSTEM COMPATIBLE
WI-FI COMPATIBLE
WORKS WITH DS-XL LED DIMMER
WORKS WITH WIRELESS CONNECTOR
CAN BE USED WITH CURVED TRACK
PLUG & PLAY
WARRANTY

✓
✓
✓
-
✓ using RS485 & dry contacts
✓
✓
✓
✓
✓
✓
10 Years

✓
✓
✓
-
✓ using RS485 & dry contacts
✓
✓
✓
✓
✓
✓
10 Years



SMART HOME
READY



APP
CONTROL



WIRELESS
REMOTE



TOUCH
CONTROL

SHUTTLE® iOn



VOLTAGE SHUTTLE	14.8V DC
RECEIVER	Internal
BATTERY	Lithium iOn battery + charger (3-4 months between charges)
MAX POWER	30W
TORQUE	1.0 Nm
TRAVEL SPEED	5.5" per second standard
NOISE LEVEL	< 40 dB(A)
MAXIMUM WEIGHT	55 lbs per motor 40 lbs per motor - curved track
DIMENSIONS	2" x 3" x 12.25"
CERTIFICATIONS/MARKINGS	CE/FCC/DOE
COLOR OPTIONS	White

SPECIFICATIONS

FEATURES

TOUCH CONTROL TECHNOLOGY	✓
INTEGRATED EMERGENCY CONTROL	✓
RF COMMUNICATION STANDARD	✓
Z-WAVE COMMUNICATION	-
AUTOMATION SYSTEM COMPATIBLE	✓ using RS485 & dry contacts
WI-FI COMPATIBLE	✓
WORKS WITH DS-XL LED DIMMER	✓
WORKS WITH WIRELESS CONNECTOR	✓
CAN BE USED WITH CURVED TRACK	✓
PLUG & PLAY	✓
WARRANTY	10 Years on motor 2 years on battery pack

Our wide variety of control options make finding a fit for your windows easy – controlling the drapes by hand, wall switch, remote or even by home automation system.



TOUCH CONTROL

Open or close your drapes with a gentle tug.



FOREST WALL SWITCH

2-channel wall switch, wireless. Can be used with all Forest Shuttle motors.



FOREST DIAMOND SENSE REMOTE

15-channel remote controls up to 15 motors individually and together, with a timer or manually. Range up to 98 feet. Wall mounted holder included.



BOND BRIDGE PRO

With the Bond Bridge Pro, easily pair your Forest remote and get app control for Forest motorized window coverings and other devices all in one place.



SIDEKICK GEN 3 REMOTE

5- or 1-channel remote control. Pairs directly with drapery motor. Use with Bond Bridge Pro or without. Estimated 10-year battery life.

FOR ADDITIONAL CONTROL OPTIONS, SEE THE ROADMAP ON THE FOLLOWING PAGES.

DRAPERY MOTORIZATION

SHUTTLE MOTORS | **CONTROLS ROADMAP** | FMS | RMS | DSXL LED | HANOVER | DRESDEN | DEVENTER MRS | CORDOBA | LONDON

HOW DO YOU WANT TO CONTROL YOUR DRAPERY?

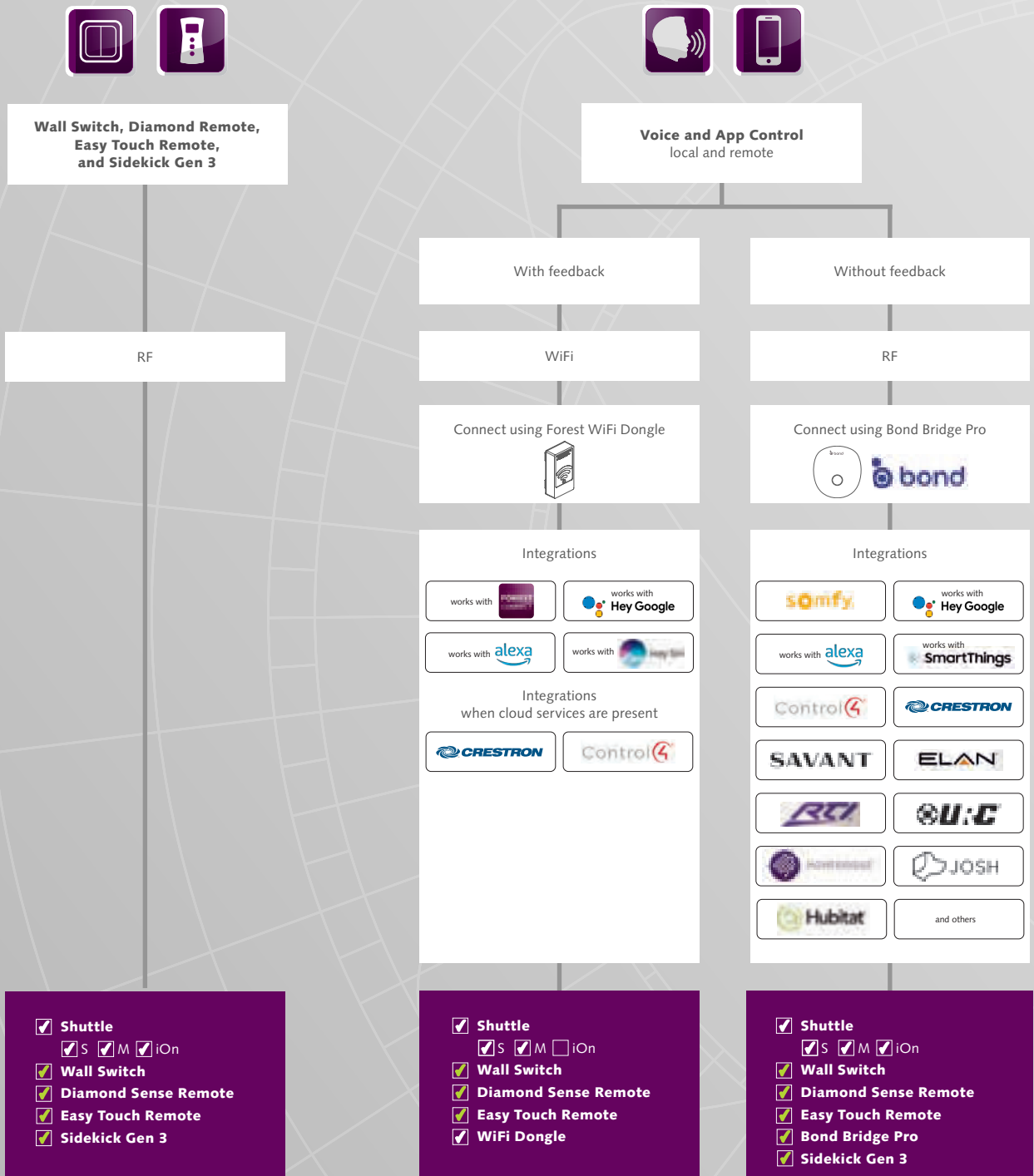



Wired Building Automation System

we advise you work with an installation specialist

With feedback

Without feedback

RS485

Dry Contact

Integrations

Control4 CRESTRON

SAVANT BCI

and others

Integrations

Control4 CRESTRON

SAVANT LUTRON

and others

- Shuttle
- S M iOn
- Wall Switch
- Diamond Sense Remote
- Easy Touch Remote
- RS485 Port

- Shuttle
- S M iOn
- Wall Switch
- Diamond Sense Remote
- Easy Touch Remote
- RS485 Port



Scan for more information on the FMS Motorized Track System



FMS® FOREST MOTORIZED SYSTEM





- The original Forest motorized track, aluminum extrusion, white, powder coated and lubricated with a patented process. Ultra-quiet and smooth operation for contract or residential applications.
- Track can be bent or curved. An actual size template is required. See pages 17-18 for more information.
- Maximum weight is 6 lbs/ft.
- Motorize with any Forest Shuttle. See all motor specifications on pages 93-94. All Forest Shuttle motors include a 10 year warranty.
- Control drapes with a gentle tug, wall switch remote, any home automation system or by smart phone app. See control options pages 95-96.



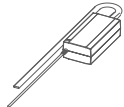

ASSEMBLED PRICING

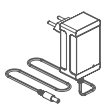
Includes track, masters, pinchpleat or ripplefold carriers, brackets, motor, and power supply plus choice of EasyTouch remote, Diamond remote or Forest wall switch. Add 10% for black. Freight is additional.

FMS MOTORIZED TRACK	first 4 feet	ea. add'l foot
Shuttle HD (M) white	\$2,369.88	\$36.99
Shuttle HD (M) black	\$2,606.87	\$40.69
Shuttle Eco (S)	\$2,156.82	\$36.99
Shuttle iOn	\$2,362.52	\$36.99

See all motor specifications on pages 93-94.

FMS	COMPONENT	PRICE
• 	52925-25 Shuttle HD (M) 52925-59 Shuttle HD (M) black 52939-25 Shuttle Eco (S) See motor specs on pages 93-94	\$1,338.39 ea. \$1,472.24 ea. \$1,062.81 ea. 1/box
• 	52928-25 Power Cord, 7' 6" 52934-25 Power Cord, 16' includes 24 volt power supply	\$170.18 ea. 1/box
• 	52926-25 Shuttle iOn Includes battery pack. Order charging cable below separately, 52924-59. See motor specs on pages 93-94	\$1,331.03 ea. 1/box
• 	52924-59 Battery Charger Charges battery included with Shuttle iOn motor above, 52926-25.	\$81.93 ea. 1/box
• 	52949-25 Battery Pack Additional battery pack for Shuttle iOn motor	\$506.17 ea. 1/box
• 	52933-25 white 59 black +10% Forest Wall Switch 2 channel	\$213.73 ea. 1/box

FMS	COMPONENT	PRICE
• 	52931-25D white 59D black +10% Diamond Sense Remote RF, 15 channel w/ holder, range 98'	\$434.19 ea. 1/box
• 	<i>COMING SOON!</i> 52960-25 white 59 black +10% EasyTouch Remote RF, 6 channel	\$303.93 ea. 1/box
• 	52948-25 59 black +10% Wi-Fi Dongle For voice and app control over wi-fi. Provides feedback (bi-directional). Use with Shuttles HD and Eco.	\$265.36 ea. 1/box
• 	52955-25 Bond Bridge Pro For voice and app control over RF. Easily pair using the Forest remote. Controls all of your devices in one hub.	\$379.00 ea. 1/box no discounts taken on this item
• 	52945-25 white Sidekick Gen 3 Remote Works with or without Bond Bridge Pro. 1-5 channels.	\$99.00 ea. 1/box

DRAPERY MOTORIZATION

SHUTTLE MOTORS | CONTROLS ROADMAP | **FMS** | RMS | DSXL LED | HANOVER | DRESDEN | DEVENTER MRS | CORDOBA | LONDON

FMS	COMPONENT	PRICE	FMS	COMPONENT	PRICE
•	 <p>51319-25 white 59 black +10% FMS Track 19' x 10 tracks per bundle bundle = 190'</p>	\$7.00/ft.	•	 <p>52009-25 Ball Bearing Carrier for motorization</p>	\$1.84 ea. \$1.51 ea. /box of 250
•	 <p>3906-25 59 black +10% Track Connector and Key 3904-00</p>	\$20.37 ea.	•	 <p>52508-25 Overlap Right 52509-25 Underlap Left 59 black +10% Belt Master Carrier</p>	\$15.51 ea. \$12.95 ea. /box of 100
•	 <p>3003-25 59 black +10% HD Klick Ceiling Bracket</p>	\$2.65 ea. \$2.19 ea. /box of 100	•	 <p>52508-25A Overlap Right 52509-25A Underlap Left 59A black +10% Belt Master Carrier with snaps</p>	\$18.39 ea. \$15.33 ea. /box of 100
•	 <p>30031-25 59 black +10% Ceiling Bracket Cover</p>	\$1.10 ea. \$0.92 ea. /box of 100	•	 <p>52410-25 Butt Right 52409-25 Butt Left 59 black +10% Butt Master Carrier with snaps</p>	\$21.38 ea. \$17.80 ea. /box of 50
•	 <p>53202-25 59 black +10% 3" Klick Single Wall Bracket with wide base adjusts 3" - 4 1/2"</p>	\$6.34 ea. \$5.28 ea. /box of 100	•	 <p>2552-25 6" Extension Arm for master Use w/ two one-way draw</p>	\$14.42 ea. \$12.03 ea. /box of 50
•	 <p>53206-25 59 black +10% 6" Klick Double Wall Bracket with wide base adjusts 2 1/2" - 4" and 6" - 7 1/2"</p>	\$11.16 ea. \$9.30 ea. /box of 50	•	 <p>52903-25 59 black +10% Forest Shuttle Motor Pulley Connects motor to track</p>	\$74.45 ea. 1/box
•	 <p>Two Piece Connected Snap Carrier w/ Square Base, in plastic sleeve. Use 1 1/4" snap tape 2114-25, 59 black 60% fullness, 2 5/8" OC 2111-25, 65 brown, 90 grey 80% fullness, 2 3/8" OC 2112-25, 59 black 100% fullness, 2 1/8" OC 2115-25, 59 black 120% fullness, 1 7/8" OC</p>	\$1.47 ea. \$1.23 ea. /roll of 500 Colors other than white +10%	•	 <p>MTDR-EP-DR-AC Rollease Motor Pulley Connects motor to track</p>	\$74.45 ea. 1/box
•	 <p>52008-25 59 black +10% Slim Line Klick Carrier Draperies hang to conceal track</p>	\$1.31 ea. \$1.08 ea. /box of 250	•	 <p>52910-25 59 black +10% Return Pulley</p>	\$42.80 ea. 1/box
			•	 <p>9012-25 Transport Belt Kevlar reinforced</p>	\$14.02/ft. \$11.66/ft. /roll 328 ft.
			•	 <p>52512-25 white 59 black +10% Transport Belt Connector</p>	\$14.51 ea. \$12.12 ea. /box of 50

BREAK PACK PRICING - Prices with this designation indicate a 20% up charge for broken pack quantities.



Scan for more information on the FOREST RMS Recessed Motorized System



RMS RECESSED MOTORIZED SYSTEM





- Heavy duty aluminum extrusion, white, powder coated and lubricated with a patented process. Ultra-quiet and smooth operation for contract or residential applications.
- Maximum weight is 8 lbs/ft.
- Motorize with any Forest Shuttle. See all motor specifications on pages 91-92. All Forest Shuttle motors include a 10 year warranty.
- Control drapes with a gentle tug, wall switch remote, any home automation system or by smart phone app. See control options pages 95-96.



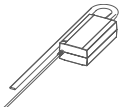

ASSEMBLED PRICING

Includes track, masters, pinchpleat or ripplefold carriers, recess profile, fixing strip, wedge, motor, pulley, cover plate, and power supply plus choice of EasyTouch remote, Diamond remote or Forest wall switch. Freight is additional.

RMS SYSTEM	first 4 feet	ea. add'l foot
Shuttle HD (M) white	\$2,481.31	\$119.76
Shuttle HD (M) black	\$2,729.44	\$131.74
Shuttle Eco (S)	\$2,489.79	\$119.76
Shuttle iOn	\$2,654.40	\$119.76

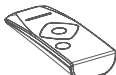









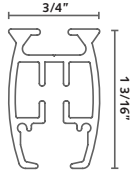
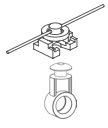

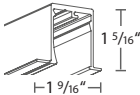
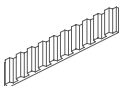

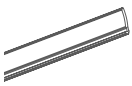
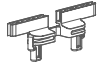
See all motor specifications on pages 93-94.

RMS	COMPONENT	PRICE
• 	52925-25 Shuttle HD (M) 52925-59 Shuttle HD (M) black 52939-25 Shuttle Eco (S) See motor specs on pages 93-94	\$1,338.39 ea. \$1,472.24 ea. \$1,062.81 ea. 1/box
• 	52928-25 Power Cord, 7' 6" 52934-25 Power Cord, 16' includes 24 volt power supply	\$170.18 ea. 1/box
• 	52926-25 Shuttle iOn Includes battery pack. Order charging cable below separately, 52924-59. See motor specs on pages 93-94	\$1,331.03 ea. 1/box
• 	52924-59 Battery Charger Charges battery included with Shuttle iOn motor above, 52926-25.	\$81.93 ea. 1/box
• 	52949-25 Battery Pack Additional battery pack for Shuttle iOn motor	\$506.17 ea. 1/box
• 	52933-25 white 59 black +10% Forest Wall Switch 2 channel	\$213.73 ea. 1/box

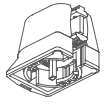
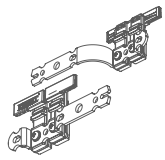
RMS	COMPONENT	PRICE
• 	52931-25D white 59D black +10% Diamond Sense Remote RF, 15 channel w/ holder, range 98'	\$434.19 ea. 1/box
• <i>COMING SOON!</i> 	52960-25 white 59 black +10% EasyTouch Remote RF, 6 channel	\$303.93 ea. 1/box
• 	52948-25 59 black +10% Wi-Fi Dongle For voice and app control over wi-fi. Provides feedback (bi-directional). Use with Shuttles HD and Eco.	\$265.36 ea. 1/box
• 	52955-25 Bond Bridge Pro For voice and app control over RF. Easily pair using the Forest remote. Controls all of your devices in one hub.	\$379.00 ea. 1/box no discounts taken on this item
• 	52945-25 white Sidekick Gen 3 Remote Works with or without Bond Bridge Pro. 1-5 channels.	\$99.00 ea. 1/box

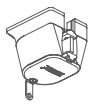
DRAPERY MOTORIZATION

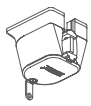
SHUTTLE MOTORS | CONTROLS ROADMAP | FMS | **RMS** | DSXL LED | HANOVER | DRESDEN | DEVENTER MRS | CORDOBA | LONDON

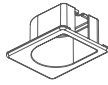
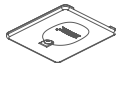
RMS	COMPONENT	PRICE	RMS	COMPONENT	PRICE
	51623-25 RMS Track white 23' x 10 tracks/bundle bundle = 230'	\$14.87/ft.		Two Piece Connected Snap Carrier w/ Square Base, in plastic sleeve. Use 1 1/4" snap tape 2114-25, 59 black 60% fullness, 2 5/8" OC 2111-25, 65 brown, 90 grey 80% fullness, 2 3/8" OC 2112-25, 59 black 100% fullness, 2 1/8" OC 2115-25, 59 black 120% fullness, 1 7/8" OC	\$1.47 ea.  \$1.23 ea. /roll of 500 Colors other than white +10%
	51723-25 Recess Profile, 23' Order same length as track	\$19.65/ft.		9112-25 Transport Belt	\$14.02/ft.  \$11.66/ft. /roll 328 ft.
	51724-25 Recess Profile Fixing Strip, 23' Order 6" shorter than track	\$4.13/ft.		52512-25 white 59 black +10% Transport Belt Connector	\$14.51 ea.  \$12.12 ea. /box of 50
	53914-25 Recess Profile Wedge Order 1 per track	\$5.80 ea.  \$4.81 ea. /box of 10		53903-25 Motor Pulley Connects motor to track	\$97.36 ea. /box
	53908-25 Overlap Right 53909-25 Underlap Left FMS Plus Master Carrier	\$46.81 ea.  \$39.01 ea. /box of 10		53910-25 Return Pulley	\$48.65 ea. /box
	52008-25 Slim Line Klick Carrier Draperies hang to conceal track	\$1.31 ea.  \$1.08 ea. /box of 250		53911-25 Upside Down Pulley	\$97.36 ea. /box
	52009-25 Ball Bearing Carrier for motorization	\$1.84 ea.  \$1.51 ea. /box of 250		53912-25 Cover Plate for Recess Motor and Return Pulley	\$5.30 ea. /box
				53913-25 Cover Plate for Recess Motor, Upside Down Motor, and Return Pulley	\$4.47 ea. /box

 **BREAK PACK PRICING**  - Prices with this designation indicate a 20% up charge for broken pack quantities.



Scan for more information on the FOREST DSXL Motorized System



DSXL® LED MOTORIZED DESIGN SYSTEM + LED LIGHTING



- Elegantly shaped aluminum extrusion, white, powder coated and lubricated with a patented process. LED lighting lights up the backside of drapery or the track itself. Ultra-quiet and smooth operation for contract or residential applications.
- LED strips have low energy consumption, are eco-friendly, dimmable. Lifespan is 30,000 hours.
- Maximum weight is 3 lbs/ft.
- Motorize with any Forest Shuttle. See all motor specifications on pages 93-94. All Forest Shuttle motors include a 10 year warranty.
- Control drapes with a gentle tug, wall switch remote, any home automation system or by smart phone app. See control options pages 95-96.



ASSEMBLED PRICING

Includes track, masters, pinchpleat or ripplefold carriers, brackets, lighting components, motor, and power supply plus choice of EasyTouch remote, Diamond remote or Forest wall switch. Freight is additional.

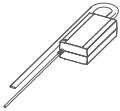
DSXL LED MOTORIZED	first 4 feet	ea. add'l foot
Shuttle HD (M) white	\$3,798.82	\$139.58
Shuttle Eco (S)	\$3,261.63	\$139.58



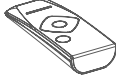







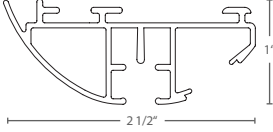
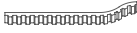





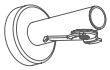

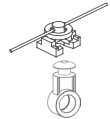
See all motor specifications on pages 93-94.

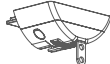

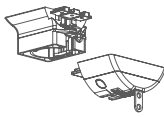
DSXL LED	COMPONENT	PRICE
• 	52925-25 Shuttle HD (M) 52925-59 Shuttle HD (M) black 52939-25 Shuttle Eco (S) See motor specs on pages 93-94	\$1,338.39 ea. \$1,472.24 ea. \$1,062.81 ea. 1/box
• 	52928-25 Power Cord, 7' 6" 52934-25 Power Cord, 16' includes 24 volt power supply	\$170.18 ea. 1/box
• 	52933-25 white 59 black +10% Diamond Sense Wall Switch 2 channel	\$213.73 ea. 1/box
• 	52931-25D white 59D black +10% Diamond Sense Remote RF, 15 channel w/ holder, range 98'	\$434.19 ea. 1/box

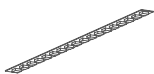
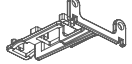
DSXL LED	COMPONENT	PRICE
• 	52948-25 59 black +10% Wi-Fi Dongle For voice and app control over wi-fi. Provides feedback (bi-directional). Use with Shuttles HD and Eco.	\$265.36 ea. 1/box
• <i>COMING SOON!</i> 	52960-25 white 59 black +10% EasyTouch Remote RF, 6 channel	\$303.93 ea. 1/box
• 	52955-25 Bond Bridge Pro For voice and app control over RF. Easily pair using the Forest remote. Controls all of your devices in one hub.	\$379.00 ea. 1/box no discounts taken on this item
• 	52945-25 white Sidekick Gen 3 Remote Works with or without Bond Bridge Pro. 1-5 channels.	\$99.00 ea. 1/box

DRAPERY MOTORIZATION

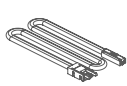
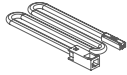
SHUTTLE MOTORS | CONTROLS ROADMAP | FMS | RMS | **DSXL LED** | HANOVER | DRESDEN | DEVENTER MRS | CORDOBA | LONDON

DSXL LED	COMPONENT	PRICE	DSXL LED	COMPONENT	PRICE
•	 <p>3219-25 DSXL LED Motorized Track white 19' x 10 tracks per bundle bundle = 190'</p>	\$21.62/ft.	•	 <p>9012-25 Transport Belt Kevlar reinforced</p>	\$14.02/ft.  \$11.66/ft. /roll 328 ft.
•	 <p>2302-25 DSXL Swivel Ceiling Bracket</p>	\$3.11 ea.  \$2.59 ea. /box of 200	•	 <p>52512-25 white Transport Belt Connector</p>	\$14.51 ea.  \$12.12 ea. /box of 50
•	 <p>2301-25 DSXL Wall Bracket w/ Swivel</p>	\$51.32 ea.  \$42.79 ea. /box of 5	•	 <p>3203-25 Motor Pulley, plastic Connects motor to track</p>	\$40.76 ea. 1/box
•	 <p>Two Piece Connected Snap Carrier w/ Square Base, in plastic sleeve. Use 1 1/4" snap tape 2114-25, 59 black 60% fullness, 2 5/8" OC 2111-25, 65 brown, 90 grey 80% fullness, 2 3/8" OC 2112-25, 59 black 100% fullness, 2 1/8" OC 2115-25, 59 black 120% fullness, 1 7/8" OC</p>	\$1.47 ea.  \$1.23 ea. /roll of 500 Colors other than white +10%	•	 <p>3204-25 Return Pulley, plastic</p>	\$16.62 ea. 1/box
•	 <p>52008-25 Slim Line Klick Carrier Draperies hang to conceal track</p>	\$1.31 ea.  \$1.08 ea. /box of 250	•	 <p>2402-25 Motor Pulley/Return Pulley Set, metal</p>	\$135.20 ea. 1/box
•	 <p>52009-25 Ball Bearing Carrier for motorization</p>	\$1.84 ea.  \$1.51 ea. /box of 250	•	 <p>3000-00 LED Strip, 3000k/24v 30,000 hr lifespan, dimmable</p>	\$70.26 ea. /19' strip \$3.70/ft.
•	 <p>9040-25 FES Butt Master</p>	\$6.22 ea.  \$5.18 ea. /box of 25	•	 <p>3010-00 LED Strip Cover</p>	\$72.04 ea. /19' strip \$3.79/ft.
			•	 <p>3030-00 Mounting Device for LED Strip</p>	\$355.60 ea.
			•	 <p>3103-25 LED Dimmer Allows control of light strip with Diamond remote.</p>	\$287.39 ea. 1/box
			•	 <p>3100-00 with 6' 6" cord 3105-25 with 13" cord LED Cable connects LED Strip 3000-00 to LED Dimmer 3103-25 24 volt</p>	\$35.02 ea. \$28.47 ea. 1/box
			•	 <p>3106-25 LED Extension Cable for LED cables 3100-00 and 3105-25 6' 6"</p>	\$31.63 ea. 1/box

 **BREAK PACK PRICING**  - Prices with this designation indicate a 20% up charge for broken pack quantities.



Scan for more information on the FOREST HANOVER Motorized System

HANOVER MOTORIZED SYSTEM

- A sleek stylish motorized profile best suited for light to medium weight draperies.
- Wall or ceiling mount. See bracket count below.

0-5' = 2 brackets	11-15' = 4 brackets
6-10' = 3 brackets	16-20' = 5 brackets
- Motorize with any Forest Shuttle. See all motor specifications on pages 93-94. All Forest Shuttle motors include a 10 year warranty.
- Control drapes with a gentle tug, wall switch, remote, any home automation system or by smart phone app. See control options pages 95-96.

ASSEMBLED PRICING

Includes rail, masters, pinchpleat or ripplefold carriers, brackets, motor, power supply, motor pulley, and return pulley plus choice of EasyTouch remote, Diamond remote or Forest wall switch. Freight is additional.





HANOVER MOTORIZED	first 4 feet	ea. add'l foot
Shuttle HD (M) white	\$5,220.92	\$496.62
Shuttle HD (M) black	\$5,743.01	\$546.28
Shuttle Eco (S)	\$4,953.88	\$496.62
Shuttle iOn	\$5,213.19	\$496.62

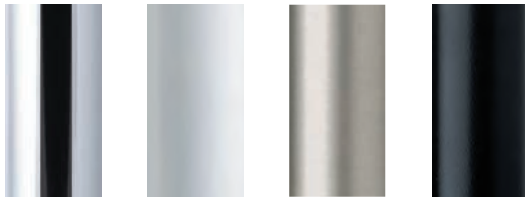

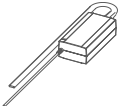

See all motor specifications on pages 93-94.

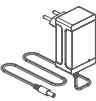
HANOVER FINISHES XX = finish color



- | | | | |
|--------------------------|----------------------|-----------------------|-------------|
| 22
Polished
Chrome | 48
Matte
White | 29
Satin
Nickel | 59
Black |
|--------------------------|----------------------|-----------------------|-------------|



HANOVER	COMPONENT	PRICE
• 	52925-25 Shuttle HD (M) 52925-59 Shuttle HD (M) black 52939-25 Shuttle Eco (S) See motor specs on pages 93-94	\$1,338.39 ea. \$1,472.24 ea. \$1,062.81 ea. 1/box
• 	52928-25 Power Cord, 7' 6" 52934-25 Power Cord, 16' includes 24 volt power supply	\$170.18 ea. 1/box
• 	52926-25 Shuttle iOn Includes battery pack. Order charging cable below separately, 52924-59. See motor specs on pages 93-94	\$1,331.03 ea. 1/box
• 	52924-59 Battery Charger Charges battery included with Shuttle iOn motor above, 52926-25.	\$81.93 ea. 1/box
• 	52949-25 Battery Pack Additional battery pack for Shuttle iOn motor	\$506.17 ea. 1/box
• 	52933-25 white 59 black +10% Forest Wall Switch 2 channel	\$213.73 ea. 1/box

HANOVER	COMPONENT	PRICE
• 	52931-25D white 59D black +10% Diamond Sense Remote RF, 15 channel w/ holder, range 98'	\$434.19 ea. 1/box
• 	<i>COMING SOON!</i> 52960-25 white 59 black +10% EasyTouch Remote RF, 6 channel	\$303.93 ea. 1/box
• 	52948-25 59 black +10% Wi-Fi Dongle For voice and app control over wi-fi. Provides feedback (bi-directional). Use with Shuttles HD and Eco.	\$265.36 ea. 1/box
• 	52955-25 Bond Bridge Pro For voice and app control over RF. Easily pair using the Forest remote. Controls all of your devices in one hub.	\$379.00 ea. 1/box no discounts taken on this item
• 	52945-25 white Sidekick Gen 3 Remote Works with or without Bond Bridge Pro. 1-5 channels.	\$99.00 ea. 1/box

DRAPERY MOTORIZATION

SHUTTLE MOTORS | CONTROLS ROADMAP | FMS | RMS | DSXL LED | **HANOVER** | DRESDEN | DEVENTER MRS | CORDOBA | LONDON

HANOVER	COMPONENT	PRICE	HANOVER	COMPONENT	PRICE
	B8223246-XX Hanover Profile 19' 7"	\$68.65/ft.		B11473-50-XX Ceiling Bracket 2" Projection	\$142.35 ea.
	B8221818-59/90 Hanover Rail	\$15.61/ft.		B11473-80-XX Ceiling Bracket 2 7/8" Projection	\$127.72 ea.
	B11679-L-46-XX Left Motor Pulley	\$886.73 ea.		B11473-15-XX Ceiling Bracket 5/8" Projection	\$73.02 ea.
	B11679-R-46-XX Right Motor Pulley	\$886.73 ea.		Two Piece Connected Snap Carrier w/ Square Base, in plastic sleeve. Use 1 1/4" snap tape 2114-25, 59 black 60% fullness, 2 5/8" OC 2111-25, 65 brown, 90 grey 80% fullness, 2 3/8" OC 2112-25, 59 black 100% fullness, 2 1/8" OC 2115-25, 59 black 120% fullness, 1 7/8" OC	\$1.47 ea.  \$1.23 ea.  /roll of 500 Colors other than white +10%
	B11683-L-46-XX Left End Pulley	\$491.16 ea.		52008-25 Slim Line Klick Carrier Draperies hang to conceal track	\$1.31 ea.  \$1.08 ea.  /box of 250
	B11683-R-46-XX Right End Pulley	\$491.16 ea.		52009-25 Ball Bearing Carrier for motorization	\$1.84 ea.  \$1.51 ea.  /box of 250
	9012-25 Transport Belt Kevlar reinforced	\$13.74/ft.  \$11.43/ft.  /roll 328 ft.		52508-25 Overlap Right 52509-25 Underlap Left 59 black +10% Belt Master Carrier	\$15.51 ea.  \$12.95 ea.  /box of 100
	52512-25 white 59 black +10% Transport Belt Connector	\$14.02/ft.  \$11.66/ft.  /roll 328 ft.		52508-25A Overlap R 52509-25A Underlap L Belt Master Carrier with snaps	\$18.39 ea.  \$15.33 ea.  /box of 100
	B11260-130-XX Extended Wall Bracket P = 4 3/4"	\$217.17 ea.		52410-25 Butt Right 52409-25 Butt Left 59 black +10% Butt Master Carrier with snaps	\$21.38 ea.  \$17.80 ea.  /box of 50
	B11592-00 Flush Ceiling Bracket	\$21.56 ea.		2552-25 6" Extension Arm for master Use w/ two one-way draw	\$14.42 ea.  \$12.03 ea.  /box of 50

 **BREAK PACK PRICING**  - Prices with this designation indicate a 20% up charge for broken pack quantities.



Scan for more information on
FOREST DRESDEN MOTORIZED



DRESDEN FINISHES XX = finish color

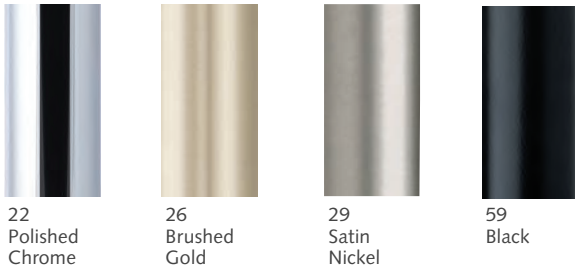

DRESDEN MOTORIZED FINIALS - OPTIONAL

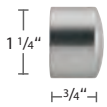

B124028-XX
End Cap Finial
\$56.65 ea.

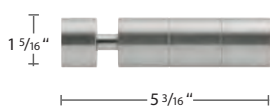

B690-XX
Pescara Finial
\$319.62 ea.

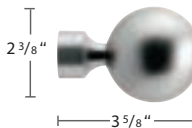

B3362-XX
Alassio Finial
\$323.64 ea.

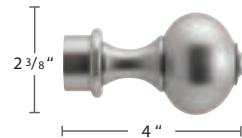

B650-22, 29, 59
Verona Finial
\$438.48 ea.



B610-XX
Napoli Finial
\$401.96 ea.

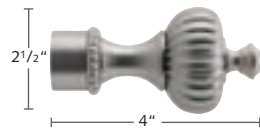

B660-22, 24, 29, 70
Roma Finial
\$567.08 ea.

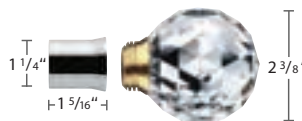

B3389-100
Ardea Finial \$540.64 ea.
B3389/1-XX
Socket for Ardea Finial \$108.72 ea.

DRESDEN MOTORIZED

- 1 1/8" motorized system best suited for light to medium weight draperies.
- Rail can be bent or curved. An actual size template is required. See pages 17-18 for more information. Polished chrome cannot be bent or curved.
- Wall or ceiling mount. See bracket count below.

0-5' = 2 brackets	11-15' = 4 brackets
6-10' = 3 brackets	16-20' = 5 brackets
- Motorize with any Forest Shuttle. See all motor specifications on pages 93-94. All Forest Shuttle motors include a 10 year warranty.
- Control drapes with a gentle tug, wall switch, remote, any home automation system or by smart phone app. See control options pages 95-96.

ASSEMBLED PRICING

Includes rail, masters, pinchpleat or ripplefold carriers, brackets, motor, power supply, motor pulley, return pulley, single wall brackets plus choice of EasyTouch remote, Diamond remote or Forest wall switch. Finials are optional and should be ordered separately. Freight is additional.

DRESDEN MOTORIZED	first 4 feet	ea. add'l foot
Shuttle HD (M) white	\$3,617.20	\$159.76
Shuttle HD (M) black	\$3,978.90	\$175.74
Shuttle Eco (S)	\$3,546.79	\$159.76
Shuttle iOn	\$3,609.83	\$159.76

See all motor specifications on pages 93-94.

DRAPERY MOTORIZATION

SHUTTLE MOTORS | CONTROLS ROADMAP | FMS | RMS | DSXL LED | HANOVER | **DRESDEN** | DEVENTER MRS | CORDOBA | LONDON

DRESDEN	COMPONENT	PRICE	DRESDEN	COMPONENT	PRICE
	B809-28-XX 1 1/8" Aluminum Rail 19' 7"	\$57.95/ft.		B11670-V-XX Adjustable Wall Bracket	\$262.96 ea.
	B899-4-00 Rail Connector	\$48.05 ea.		B11873-50-XX Ceiling Bracket	\$262.96 ea.
	B11679-L-XX B11679-R-XX Forest Shuttle Motor Pulley	\$667.54 ea.		B11873-15-XX Ceiling Bracket 5/8" Projection	\$68.78 ea.
	B11699-L-XX B11699-R-XX Somfy Motor Pulley	\$599.88 ea.		53408-22,24,29,59 Flush Ceiling Bracket Cannot use finials with this bracket	\$25.56 ea.
	B11669-L-XX B11669-R-XX Lutron Motor Pulley	\$777.55 ea.		Two Piece Connected Snap Carrier w/ Square Base, in plastic sleeve. Use 1 1/4" snap tape 2114-25, 59 black 60% fullness, 2 5/8" OC 2111-25, 65 brown, 90 grey 80% fullness, 2 3/8" OC 2112-25, 59 black 100% fullness, 2 1/8" OC 2115-25, 59 black 120% fullness, 1 7/8" OC	\$1.47 ea.  \$1.23 ea.  /roll of 500 Colors other than white +10%
	B11659-L-22,29,59 B11659-R-22,29,59 Rollease Motor Pulley	\$734.29 ea.		52008-25 Slim Line Klick Carrier Draperies hand to conceal track	\$1.31 ea.  \$1.08 ea.  /box of 250
	B11683-L-XX B11683-R-XX Standard Return Pulley	\$303.43 ea.		52009-25 Ball Bearing Carrier for motorization	\$1.84 ea.  \$1.51 ea.  /box of 250
	B11683-41-XX Short Return Pulley for one-way draw	\$202.34 ea.		52508-25 Overlap R 52509-25 Underlap L Belt Master Carrier	\$15.51 ea.  \$12.95 ea.  /box of 100
	B122028-XX Inside Mount Bracket	\$113.26 ea.		52508-25A Overlap R 52509-25A Underlap L Belt Master Carrier with snaps	\$18.39 ea.  \$15.33 ea.  /box of 100
	9012-25 Transport Belt Kevlar reinforced	\$14.02/ft.  \$11.66/ft.  /roll 328 ft.		52410-25 Butt Right 52409-25 Butt Left 59 black +10% Butt Master Carrier with snaps	\$21.38 ea.  \$17.80 ea.  /box of 50
	52512-25 white 59 black +10% Transport Belt Connector	\$14.51 ea.  \$12.12 ea.  /box of 50		2552-25 6" Extension Arm for master Use w/ two one-way draw	\$14.42 ea.  \$12.03 ea.  /box of 50
	B11670-120-XX Single Bracket	\$189.07 ea.			
	B11672-220-XX Double Bracket	\$214.43 ea.			

 **BREAK PACK PRICING**  - Prices with this designation indicate a 20% up charge for broken pack quantities.

DRAPERY MOTORIZATION

SHUTTLE MOTORS | CONTROLS ROADMAP | FMS | RMS | DSXL LED | HANOVER | **DRESDEN** | DEVENTER MRS | CORDOBA | LONDON

WEAR RESISTANT PULLEY HOUSING

For low wear operation the pulley housing has been equipped with high quality ball bearings.



REINFORCED BELT



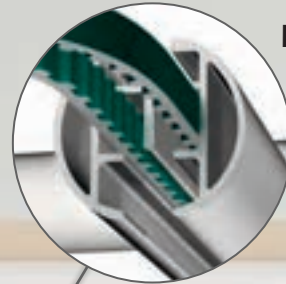

The Kevlar reinforced belt runs quietly and has superior longevity.





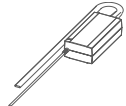

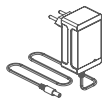
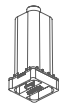
FOREST SHUTTLE MOTORS

- Touch Impulse Technology opens or closes drapes with a gentle tug.
- Integrated emergency control insures manual operation of the drapery in case of power failure.
- Choose the Forest Shuttle Eco for lightweight fabrics.
- Choose the Forest Shuttle HD for strength at an economical price.
- Choose the Shuttle iOn when a power source is not close by.
- All Forest Shuttle motors come with a 10-year warranty.

DRAPERY MOTORIZATION DRESDEN

DRESDEN	COMPONENT	PRICE
	52925-25 Shuttle HD (M) 52925-59 Shuttle HD (M) black 52939-25 Shuttle Eco (S) See motor specs on pages 93-94	\$1,338.39 ea. \$1,472.24 ea. \$1,062.81 ea. 1/box
	52928-25 Power Cord, 7' 6" 52934-25 Power Cord, 16' includes 24 volt power supply	\$170.18 ea. 1/box
	52926-25 Shuttle iOn Includes battery pack. Order charging cable below separately, 52924-59. See motor specs on pages 93-94	\$1,331.03 ea. 1/box
	52924-59 Battery Charger Charges battery included with Shuttle iOn motor above, 52926-25.	\$81.93 ea. 1/box
	52949-25 Battery Pack Additional battery pack for Shuttle iOn motor	\$506.17 ea. 1/box
	52933-25 white 59 black +10% Forest Wall Switch 2 channel	\$213.73 ea. 1/box

DRESDEN	COMPONENT	PRICE
	52931-25D white 59D black +10% Diamond Sense Remote RF, 15 channel w/ holder, range 98'	\$434.19 ea. 1/box
	COMING SOON! 52960-25 white 59 black +10% EasyTouch Remote RF, 6 channel	\$303.93 ea. 1/box
	52948-25 59 black +10% Wi-Fi Dongle For voice and app control over wi-fi. Provides feedback (bi-directional). Use with Shuttles HD and Eco.	\$265.36 ea. 1/box
	52955-25 Bond Bridge Pro For voice and app control over RF. Easily pair using the Forest remote. Controls all of your devices in one hub.	\$379.00 ea. 1/box no discounts taken on this item
	52945-25 white Sidekick Gen 3 Remote Works with or without Bond Bridge Pro. 1-5 channels.	\$99.00 ea. 1/box

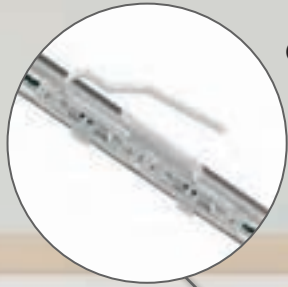

COMPLETELY CLOSED DRAPERIES USING OVERLAP MASTERS

The overlap master carrier guarantees a complete 3" overlap of the draperies. Extended arms available.

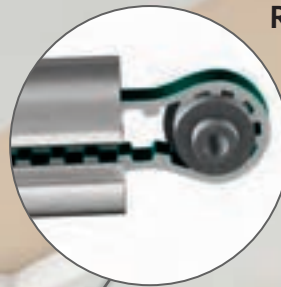

RETURN PULLEY

The return pulley is made of a special plastic and uses a bearing which allows ultra-smooth operation.



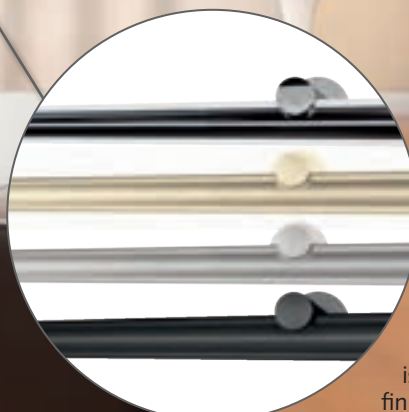
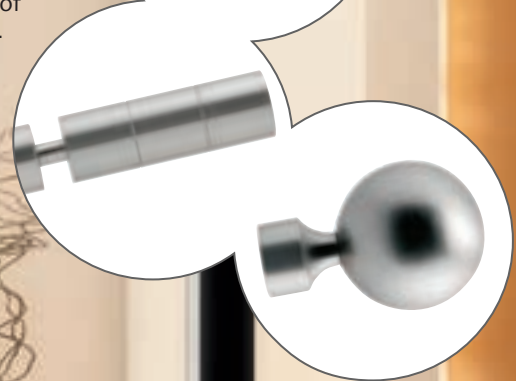

SELECT YOUR INDIVIDUAL FINIAL

Our decorative finials offer a variety of design options. See all finials on page 99. Finials are optional.



HIGH-GRADE ALUMINUM:

Dresden Motorized is available in the finishes below.

- Polished Chrome - 22 
- Brushed Gold - 26 
- Satin Nickel - 29 
- Black - 59 



Scan for more information on
FOREST DEVENTER MRS MOTORIZED



MRS COLLECTION FINISHES XX = finish color

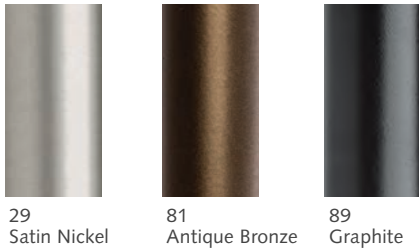

DEVENTER MRS[®] MOTORIZED





- 1 1/8" motorized system best suited for light to medium weight draperies.
- Wall or ceiling mount. See bracket count below.
 - 0-5' = 2 brackets 11-15' = 4 brackets
 - 6-10' = 3 brackets 16-20' = 5 brackets
- Motorize with any Forest Shuttle. See all motor specifications on pages 93-94. All Forest Shuttle motors include a 10 year warranty.
- Control drapes with a gentle tug, wall switch, remote, any home automation system or by smart phone app. See control options pages 95-96.



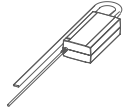

ASSEMBLED PRICING

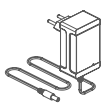
Includes rail, motor, power supply, motor pulley, return pulley, wall or ceiling brackets, carriers, and masters plus EasyTouch remote, Diamond remote or Forest wall switch. Double sets are available. Freight is additional.

DEVENTER MRS MOTORIZED	first 4 feet	ea. add'l foot
Shuttle HD (M) white	\$3,277.25	\$100.41
Shuttle HD (M) black	\$3,604.98	\$110.45
Shuttle Eco (S)	\$3,210.77	\$100.41
Shuttle iOn	\$3,364.43	\$100.41

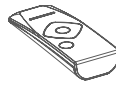
See all motor specifications on pages 93-94.

DEV MRS	COMPONENT	PRICE
• 	52925-25 Shuttle HD (M) 52925-59 Shuttle HD (M) black 52939-25 Shuttle Eco (S) See motor specs on pages 93-94	\$1,338.39 ea. \$1,472.24 ea. \$1,062.81 ea. 1/box
• 	52928-25 Power Cord, 7' 6" 52934-25 Power Cord, 16' includes 24 volt power supply	\$170.18 ea. 1/box
• 	52926-25 Shuttle iOn Includes battery pack. Order charging cable below separately, 52924-59. See motor specs on pages 93-94	\$1,331.03 ea. 1/box
• 	52924-59 Battery Charger Charges battery included with Shuttle iOn motor above, 52926-25.	\$81.93 ea. 1/box
• 	52949-25 Battery Pack Additional battery pack for Shuttle iOn motor	\$506.17 ea. 1/box
• 	52933-25 white 59 black +10% Forest Wall Switch 2 channel	\$213.73 ea. 1/box

DEV MRS	COMPONENT	PRICE
• 	52931-25D white 59D black +10% Diamond Sense Remote RF, 15 channel w/ holder, range 98'	\$434.19 ea. 1/box
• <i>COMING SOON!</i> 	52960-25 white 59 black +10% EasyTouch Remote RF, 6 channel	\$303.93 ea. 1/box
• 	52948-25 59 black +10% Wi-Fi Dongle For voice and app control over wi-fi. Provides feedback (bi-directional). Use with Shuttles HD and Eco.	\$265.36 ea. 1/box
• 	52955-25 Bond Bridge Pro For voice and app control over RF. Easily pair using the Forest remote. Controls all of your devices in one hub.	\$379.00 ea. 1/box no discounts taken on this item
• 	52945-25 white Sidekick Gen 3 Remote Works with or without Bond Bridge Pro. 1-5 channels.	\$99.00 ea. 1/box

DRAPERY MOTORIZATION

SHUTTLE MOTORS | CONTROLS ROADMAP | FMS | RMS | DSXL LED | HANOVER | DRESDEN | **DEVENTER MRS** | CORDOBA | LONDON

DEV MRS	COMPONENT	PRICE	DEV MRS	COMPONENT	PRICE
	51919-XX 1 1/8" Aluminum Rail 19' 7"	\$56.21/ft.		52430-XX End Cap Finial	\$48.47 ea. 10/box
	53413-90 Rail Connector aluminum, 3"	\$23.76 ea. 25/box		52431-XX Ball Finial	\$101.60 ea. 10/box
	51901-XX Left Motor Pulley 51902-XX Right Motor Pulley	\$463.60 ea.		52432-XX Notched Finial	\$55.97 ea. 10/box
	51903-XX Left Return Pulley 51904-XX Right Return Pulley	\$200.12 ea.		53408-25, 29, 59, 81 Flush Ceiling Bracket Cannot use finials	\$25.56 ea.
	51905-XX Motor Pulley Universal	\$427.89 ea.		Two Piece Connected Snap Carrier w/ Square Base, in plastic sleeve. Use 1 1/4" snap tape 2114-25, 59 black 60% fullness, 2 5/8" OC 2111-25, 65 brown, 90 grey 80% fullness, 2 3/8" OC 2112-25, 59 black 100% fullness, 2 1/8" OC 2115-25, 59 black 120% fullness, 1 7/8" OC	\$1.47 ea.  \$1.23 ea. /roll of 500 Colors other than white +10%
	51906-25, 59 Motor Pulley Universal Cap Set	\$4.10 ea.		52008-25 59 black, 65 brown +10% Slim Line Klick Carrier Draperies hang to conceal track	\$1.31 ea.  \$1.08 ea. /box of 250
	51907-XX Motor Pulley Universal End Cap Finial	\$81.04 ea.		52009-25 Ball Bearing Carrier for motorization	\$1.84 ea.  \$1.51 ea. /box of 250
	51908-XX Reutrn Pulley Universal	\$219.92 ea.		52508-25 Overlap R 52509-25 Underlap L Belt Master Carrier	\$15.51 ea.  \$12.95 ea. /box of 100
	9012-25 Transport Belt Kevlar reinforced	\$14.02/ft.  \$11.66/ft. /roll 328 ft.		52508-25A Overlap R 52509-25A Underlap L Belt Master Carrier with snaps	\$18.39 ea.  \$15.33 ea. /box of 100
	52512-25 white 59 black +10% Transport Belt Connector	\$14.51 ea.  \$12.12 ea. /box of 50		52410-25 Butt Right 52409-25 Butt Left 59 black +10% Butt Master Carrier with snaps	\$21.38 ea.  \$17.80 ea. /box of 50
	53402-XX Extended Single Bracket	\$92.22 ea. 2/box			
	53412-XX Inside Mount Bracket	\$110.78 ea.			

 **BREAK PACK PRICING**  - Prices with this designation indicate a 20% up charge for broken pack quantities.



CORDOBA MOTORIZED

- Forest FMS Track with 2" Cordoba Collection wood pole fascia
- Motorize with any Forest Shuttle. See all motor specifications on pages 93-94. All Forest Shuttle motors include a 10 year warranty.
- Control drapes with a gentle tug, wall switch, remote, any home automation system or by smart phone app. See control options pages 95-96.

ASSEMBLED PRICING

Includes assembled track, wood fascia, motor, power supply, and brackets plus EasyTouch remote, Diamond remote or Forest wall switch. Add 10% for black motor and track. Freight is additional.

CORDOBA MOTORIZED	HD (M) white first 4 feet	Eco (S) first 4 feet	iOn first 4 feet	All ea. add'l ft.
2" Single Unfinished	\$2,459.04	\$2,251.62	\$2,245.58	\$68.16
2" Single Finished	\$2,529.59	\$2,322.20	\$2,316.14	\$82.96
2" Double Unfinished	\$4,661.66	\$4,454.25	\$4,448.20	\$121.48
2" Double Finished	\$4,742.70	\$4,535.29	\$4,529.24	\$128.89

See all motor specifications on pages 93-94.









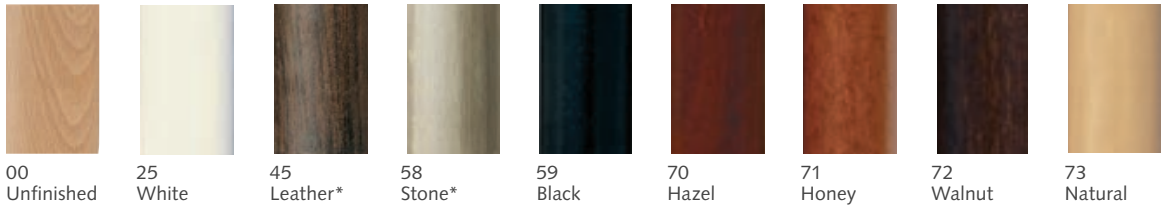

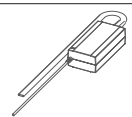
Scan for more information on
FOREST MOTORIZED CORDOBA

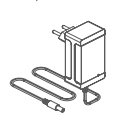
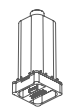

CORDOBA COLLECTION FINISHES XX = finish color







CORDOBA	COMPONENT	PRICE
•	 52925-25 Shuttle HD (M) 52925-59 Shuttle HD (M) black 52939-25 Shuttle Eco (S) See motor specs on pages 93-94	\$1,338.39 ea. \$1,472.24 ea. \$1,062.81 ea. 1/box
•	 52928-25 Power Cord, 7' 6" 52934-25 Power Cord, 16' includes 24 volt power supply	\$170.18 ea. 1/box
•	 52926-25 Shuttle iOn Includes battery pack. Order charging cable below separately, 52924-59. See motor specs on pages 93-94	\$1,331.03 ea. 1/box
•	 52924-59 Battery Charger Charges battery included with Shuttle iOn motor above, 52926-25.	\$81.93 ea. 1/box
•	 52949-25 Battery Pack Additional battery pack for Shuttle iOn motor	\$506.17 ea. 1/box
•	 52933-25 white 59 black +10% Forest Wall Switch 2 channel	\$213.73 ea. 1/box

CORDOBA	COMPONENT	PRICE
•	 52931-25D white 59D black +10% Diamond Sense Remote RF, 15 channel w/ holder, range 98'	\$434.19 ea. 1/box
•	 COMING SOON! 52960-25 white 59 black +10% EasyTouch Remote RF, 6 channel	\$303.93 ea. 1/box
•	 52948-25 59 black +10% Wi-Fi Dongle For voice and app control over wi-fi. Provides feedback (bi-directional). Use with Shuttles HD and Eco.	\$265.36 ea. 1/box
•	 52955-25 Bond Bridge Pro For voice and app control over RF. Easily pair using the Forest remote. Controls all of your devices in one hub.	\$379.00 ea. 1/box no discounts taken on this item
•	 52945-25 white Sidekick Gen 3 Remote Works with or without Bond Bridge Pro. 1-5 channels.	\$99.00 ea. 1/box

DRAPERY MOTORIZATION

SHUTTLE MOTORS | CONTROLS ROADMAP | FMS | RMS | DSXL LED | HANOVER | DRESDEN | DEVENTER MRS | **CORDOBA** | LONDON

CORDOBA	COMPONENT	PRICE	CORDOBA	COMPONENT	PRICE
	 <p>51323-25 white 59 black +10% FMS Track 23' x 10 tracks per bundle bundle = 230'</p>	\$7.00/ft.		 <p>52009-25 Ball Bearing Carrier for motorization</p>	\$1.84 ea.  \$1.51 ea. /box of 250
	 <p>1051RSW-XX 2" Cordoba Smooth, 14'</p>	See pricing pages 63 & 65		 <p>52508-25 Overlap Right 52509-25 Underlap Left 59 black +10% Belt Master Carrier</p>	\$15.51 ea.  \$12.95 ea. /box of 100
	 <p>1051RRW-XX 2" Cordoba Reeded, 14'</p>	See pricing pages 63 & 65		 <p>52508-25A Overlap Right 52509-25A Underlap Left 59A black +10% Belt Master Carrier with snaps</p>	\$18.39 ea.  \$15.33 ea. /box of 100
	 <p>1151WEN-XX 2" Cordoba End Cap See all finials page 80</p>	See pricing pages 63 & 65		 <p>52410-25 Butt Right 52409-25 Butt Left 59 black +10% Butt Master Carrier with snaps</p>	\$21.38 ea.  \$17.80 ea. /box of 50
	 <p>3906-25 59 black +10% Track Connector & key 3904-00</p>	\$20.37 ea.		 <p>2552-25 6" Extension Arm for master Use w/ two one-way draw</p>	\$14.42 ea.  \$12.03 ea. /box of 50
	 <p>3280-25 59 black +10% 3" Single Wall Bracket heavy duty projection 2 1/2"</p>	\$14.58 ea.  \$12.15 ea. /box of 20		 <p>52903-25 59 black +10% Forest Shuttle Motor Pulley Connects motor to track</p>	\$74.45 ea. 1/box
	 <p>3281-25 59 black +10% 6" Double Wall Bracket heavy duty projection 1 1/2", 5 1/2"</p>	\$20.90 ea.  \$17.41 ea. /box of 15		 <p>MTDR-EP-DR-AC Rollese Motor Pulley Connects motor to track</p>	\$74.45 ea. 1/box
	 <p>32801-25 59 black +10% Wall Bracket Cover use with 3280 & 3281</p>	\$3.76 ea.  \$3.13 ea. /box of 50		 <p>52910-25 59 black +10% Return Pulley</p>	\$42.80 ea. 1/box
	 <p>2114-25 60% fullness 2 5/8" OC 2111-25 80% fullness 2 3/8" OC 2112-25 100% fullness 2 1/8" OC 2115-25 120% fullness 1 7/8" OC 59 black +10% Two-Piece Connected Snap Carrier w/ Square Base, use 4 1/4" snap tape.</p>	\$1.47 ea.  \$1.23 ea. /roll of 500		 <p>9012-25 Transport Belt Kevlar reinforced</p>	\$14.02/ft.  \$11.66/ft. /roll 328 ft.
	 <p>52008-25 59 black +10% Slim Line Klick Carrier Draperies hang to conceal track</p>	\$1.31 ea.  \$1.08 ea. /box of 250		 <p>52512-25 white 59 black +10% Transport Belt Connector</p>	\$14.51 ea.  \$12.12 ea. /box of 50

 **BREAK PACK PRICING**  - Prices with this designation indicate a 20% up charge for broken pack quantities.



LONDON MOTORIZED

- Forest FMS Track with 1 3/4" London Collection wood pole fascia.
- Motorize with any Forest Shuttle. See all motor specifications on pages 93-94. All Forest Shuttle motors include a 10 year warranty.
- Control drapes with a gentle tug, wall switch, remote, any home automation system or by smart phone app. See control options pages 95-96.

ASSEMBLED PRICING

Includes assembled track, wood fascia, motor, power supply, and brackets plus EasyTouch remote, Diamond remote or Forest wall switch. Finials are additional and can be found on page 88. Add 10% for black motor and track. Freight is additional.



Scan for more information on FOREST MOTORIZED LONDON



LONDON MOTORIZED	HD (M) white first 4 feet	Eco (S) first 4 feet	iOn first 4 feet	All ea. add'l ft.
Single	\$2,664.97	\$2,410.64	\$2,569.36	\$128.96
Double	\$5,213.71	\$4,830.00	\$4,993.78	\$205.68

LONDON COLLECTION FINISHES XX = finish color









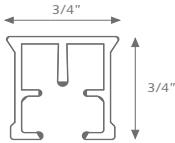

WOOD POLE & COMPONENTS FINISHES					METAL COMPONENT FINISHES			
50 Oil Rubbed Bronze	51 Antique Gold	52 Burnished Gold	53 Dark Pewter	54 Distressed Ivory	22 Polished Chrome	23 Polished Brass	29 Satin Nickel	89 Graphite

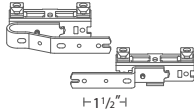
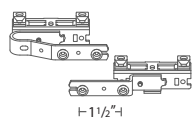
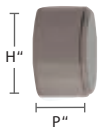
LONDON	COMPONENT	PRICE
•	52925-25 Shuttle HD (M) 52925-59 Shuttle HD (M) black 52939-25 Shuttle Eco (S) See motor specs on pages 93-94	\$1,338.39 ea. \$1,472.24 ea. \$1,062.81 ea. 1/box
•	52928-25 Power Cord, 7' 6" 52934-25 Power Cord, 16' includes 24 volt power supply	\$170.18 ea. 1/box
•	52926-25 Shuttle iOn Includes battery pack. Order charging cable below separately, 52924-59. See motor specs on pages 93-94	\$1,331.03 ea. 1/box
•	52924-59 Battery Charger Charges battery included with Shuttle iOn motor above, 52926-25.	\$81.93 ea. 1/box
•	52949-25 Battery Pack Additional battery pack for Shuttle iOn motor	\$506.17 ea. 1/box
•	52933-25 white 59 black +10% Forest Wall Switch 2 channel	\$213.73 ea. 1/box

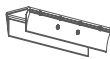
LONDON	COMPONENT	PRICE
•	52931-25D white 59D black +10% Diamond Sense Remote RF, 15 channel w/ holder, range 98'	\$434.19 ea. 1/box
• <i>COMING SOON!</i>	52960-25 white 59 black +10% EasyTouch Remote RF, 6 channel	\$303.93 ea. 1/box
•	52948-25 59 black +10% Wi-Fi Dongle For voice and app control over wi-fi. Provides feedback (bi-directional). Use with Shuttles HD and Eco.	\$265.36 ea. 1/box
•	52955-25 Bond Bridge Pro For voice and app control over RF. Easily pair using the Forest remote. Controls all of your devices in one hub.	\$379.00 ea. 1/box no discounts taken on this item
•	52945-25 white Sidekick Gen 3 Remote Works with or without Bond Bridge Pro. 1-5 channels.	\$99.00 ea. 1/box

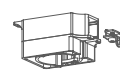
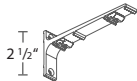
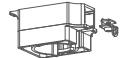
DRAPERY MOTORIZATION

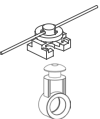
SHUTTLE MOTORS | CONTROLS ROADMAP | FMS | RMS | DSXL LED | HANOVER | DRESDEN | DEVENTER MRS | CORDOBA | **LONDON**

LONDON	COMPONENT	PRICE	LONDON	COMPONENT	PRICE
•	 <p>51323-25 white 59 black +10% FMS Track 23' x 10 tracks per bundle bundle = 230'</p>	\$7.00/ft.	•	 <p>52009-25 Ball Bearing Carrier for motorization</p>	\$1.84 ea. \$1.51 ea. /box of 250
•	 <p>1045RSW-5X 1 3/4" Routed Wood Pole, 10'</p>	\$61.63/ft.	•	 <p>52508-25 Overlap Right 52509-25 Underlap Left 59 black +10% Belt Master Carrier</p>	\$15.51 ea. \$12.95 ea. /box of 100
•	 <p>1145MOD-5X 1 3/4" London Modern End Cap H: 2" P: 1"</p>	See all London finial options and pricing on page 88.	•	 <p>52508-25A Overlap Right 52509-25A Underlap Left 59A black +10% Belt Master Carrier with snaps</p>	\$18.39 ea. \$15.33 ea. /box of 100
•	 <p>3045END-XX 1 3/4" Glasgow End Cap Finial H: 2" P: 1 1/8"</p>	See all London finial options and pricing on page 88.	•	 <p>52410-25 Butt Right 52409-25 Butt Left 59 black +10% Butt Master Carrier with snaps</p>	\$21.38 ea. \$17.80 ea. /box of 50
•	 <p>3906-25 59 black +10% Track Connector & key 3904-00</p>	\$20.37 ea.	•	 <p>2552-25 6" Extension Arm for master Use w/ two one-way draw</p>	\$14.42 ea. \$12.03 ea. /box of 50
•	 <p>3280-25 59 black +10% 3" Single Wall Bracket heavy duty projection 2 1/2"</p>	\$14.58 ea. \$12.15 ea. /box of 20	•	 <p>52903-25 59 black +10% Forest Shuttle Motor Pulley Connects motor to track</p>	\$74.45 ea. 1/box
•	 <p>3281-25 59 black +10% 6" Double Wall Bracket heavy duty projection 1 1/2", 5 1/2"</p>	\$20.90 ea. \$17.41 ea. /box of 15	•	 <p>MTDR-EP-DR-AC Rollease Motor Pulley Connects motor to track</p>	\$74.45 ea. 1/box
•	 <p>32801-25 59 black +10% Wall Bracket Cover use with 3280 & 3281</p>	\$3.76 ea. \$3.13 ea. /box of 50	•	 <p>52910-25 59 black +10% Return Pulley</p>	\$42.80 ea. 1/box
•	 <p>2114-25 60% fullness 2 5/8" OC 2111-25 80% fullness 2 3/8" OC 2112-25 100% fullness 2 1/8" OC 2115-25 120% fullness 1 7/8" OC 59 black +10% Two-Piece Connected Snap Carrier w/ Square Base, use 4 1/4" snap tape.</p>	\$1.47 ea. \$1.23 ea. /roll of 500	•	 <p>9012-25 Transport Belt Kevlar reinforced</p>	\$14.02/ft. \$11.66/ft. /roll 328 ft.
•	 <p>52008-25 59 black +10% Slim Line Klick Carrier Draperies hang to conceal track</p>	\$1.31 ea. \$1.08 ea. /box of 250	•	 <p>52512-25 white 59 black +10% Transport Belt Connector</p>	\$14.51 ea. \$12.12 ea. /box of 50

BREAK PACK PRICING - Prices with this designation indicate a 20% up charge for broken pack quantities.



APPENDIX

In this section you will find Forest terms & conditions, ordering instructions, warranty information, return instructions, care instructions, ripplefold carrier counts, and many marketing and technical support options.

THE
WORLD
BEHIND
YOUR
DRAPERIES



TERMS & CONDITIONS

Applicant, to induce Forest Drapery Hardware (FDH) to consider providing goods on credit to Applicant, hereby agrees for itself, its successors, and permitted assigns, that the following terms and conditions shall apply to all sales of goods (the "Goods") by FDH to applicant.

1. Applicant is applying for credit for business purposes. Applicant authorizes all financial institutions and business entities of which FDH may from time to time make inquiry to provide FDH such financial information, as FDH deems necessary to make credit decisions. FDH has no obligation to extend credit to Applicant and may in its sole discretion suspend, terminate or reduce the limits of any extensions of credit at any time and withhold shipments of Goods ordered, or require cash in advance, in the event FDH, in its sole discretion, finds Applicant's financial condition to be unsatisfactory.
2. FDH will provide to Applicant an itemized invoice for each sale. If Applicant does not give written notice to FDH within fifteen (15) calendar days from the date of such invoice of any objection to the Goods listed, the receipt thereof, that such purchase was unauthorized or any other objection, all such objections shall be deemed waived. Applicant waives any and all right to set off claims, which it may assert against FDH, and/or to withhold payment to FDH based on a claim that FDH is indebted to Applicant. No claim asserted by Applicant against FDH shall relieve Applicant of its obligation to make timely payments to FDH.
3. Except as otherwise set forth in a FDH Invoice, payment is due by the 30th day following the date of the invoice. Payments become past due after the 30th day. Applicant agrees that all amounts in past due shall bear interest at 1.5% per month pre- and post-judgment until paid and agrees to pay FDH, in addition to the amount due, attorneys' fees of fifteen percent (15%) of the amount due, or the maximum amount allowed by law, whichever is greater, in the event the account is placed in collections with an attorney, or any other means of collection, and also to pay any and all attorneys' fees and costs associated with post-judgment collection preparation and recording fees. Applicant agrees that all payments shall be applied to Applicant's account as designated in writing and if not designated in writing then FDH shall apply said payments to the most outstanding invoices. This Agreement shall be deemed fully executed and performed in Bartow County, Georgia, and will be governed and construed in accordance with the laws of Georgia. Applicant agrees to examine all invoices and statements promptly upon receipt and to notify FDH immediately at any failure of delivery, shortage, discrepancy or error and further agrees that such invoice or statement shall be presumed correct unless Applicant shall notify FDH in writing of such failure of delivery, shortage, discrepancy or error within thirty (30) calendar days of Applicant's receipt of such invoice or statement. Use of materials by Applicant shall constitute a waiver of any error in shipment or defect in materials, which might have been determined by a prompt and diligent inspection thereof.
4. Any waiver or non-enforcement by FDH of a breach, default or term under this Agreement shall not be deemed a waiver of any subsequent breach or default of enforcement of such term and FDH shall only be deemed to have given as much in writing executed by FDH providing for such waiver. If any provision of this Agreement is waived by FDH or is held to be invalid or unenforceable, all other provisions shall nevertheless continue in full force and effect as if such provision were not contained herein.
5. This Agreement contains the entire agreement and understanding between FDH and Applicant with respect to the sale of Goods by FDH to Applicant (other than payment terms and delivery dates to be set forth in FDH invoices), supersedes all prior agreements, commitments, representations and discussions between FDH and Applicant and is not assignable by Applicant without the prior written consent of FDH. No modifications, amendments or additions to this agreement will be binding on FDH unless such modification, amendment or addition is in writing executed by FDH. Without limitation of the forgoing, the terms hereof shall not be modified, amended or added to by the terms of any purchase order or similar document submitted by Applicant to FDH. The terms here of shall be altered or interpreted by reference to any course of dealing between FDH and Applicant of industry practice. Any action by Applicant instituted against FDH arising from Goods sold must be commenced within one (1) year from date of delivery of the subject of Goods.
6. Applicant shall have seven (7) calendar days from the date of delivery to reject Goods as nonconforming. Such rejection must be in writing received by FDH within such seven (7) calendar days, and specify the Goods rejected and the specific nonconformity asserted and the subject Goods must be received by FDH within ten (10) calendar days from the delivery date of Goods. All Goods not so rejected shall conclusively be deemed to have been accepted. In order to effect such rejection, the Goods returned must be accompanied by a copy of the original invoice or other proof of purchase by Applicant. No charges or expenses incident to any claims will be allowed unless approved by an authorized representative of FDH. Goods shall not be returned to FDH without FDH permission and such returns will only be accepted when return authorization numbers, given by FDH, is mentioned on the Goods and bill of lading. Physical acceptance by FDH of Goods returned may in no way be deemed agreement by FDH of any claim by Applicant of nonconformity.
7. FDH shall have a reasonable time after receipt of proper notice of rejection of nonconformity Goods of revocation of acceptance of nonconformity Goods to repair or replace the Goods or refund the purchase price, with the remedy to be selected by FDH in its sole discretion. If Applicant otherwise has an outstanding balance, the refund shall be in the form of a credit to Applicant's account.
8. Applicant is responsible for determining the Goods it chooses to purchase and for what purposes those Goods will be used and Applicant will not be relying on the skill or judgment of FDH to select or furnish Goods suitable for any particular purpose. FDH MAKES NO REPRESENTATIONS OR WARRANTIES, EXPRESS OR IMPLIED, INCLUDING BUT NOT LIMITED TO WARRANTIES OF FITNESS OR SUITABILITY FOR ANY PURPOSE, AND/OR THE MERCHANTABILITY OF ANY GOODS. Applicant agrees that its sole and exclusive remedy against FDH for defective or nonconforming Goods shall be repair or replacement of such Goods, or refund of purchase price, with the remedy to be selected by FDH at its sole discretion. Applicant hereby waives all other remedies, and in no event shall FDH be liable for any negligence or general, incidental, special, consequent or other damages suffered by Applicant or any other party for lost profit, sales, labor, injury to person or property or any other loss. FDH may deliver certain third-party manufacturer warranties to Applicant, but FDH shall have no liability under such warranties.
9. The undersigned unconditionally personally guarantees the timely payment of all amounts due from Applicant to FDH and agrees to be jointly and severally liable with the Applicant to FDH for any debt owed by the Applicant, The undersigned agrees to pay reasonable attorneys' fees equal to 15% of the outstanding principal and interest owed by the Applicant in the event that the Applicant's account is placed in collections with an attorney or any other means of collection. This personal guarantee may only be revoked in writing sent by certified mail to FDH. Said revocation shall not be effective as to any balance owed prior to receipt of said revocation. The undersigned hereby expressly waives notice of acceptance of this instrument, notice of any default, non-payment, partial payment, presentment, protest, demand and any and all other notices whatsoever.

APPENDIX

T&C | **ORDERING INFORMATION** | RETURNS, WARRANTY & CARE | CARRIER COUNTS | PRODUCT SUPPORT | SALES AIDS

ORDERING INFORMATION



OPEN AN ACCOUNT

Forest sells to the trade only. If you are a member of the trade and want to open an account, consider that volume of purchases from Forest will determine your discount structure. Using a local distributor may save you shipping time and provide better pricing. See below to find a distributor in your area. If you would like to open an account with Forest, scan this code to go to the new customer forms on the Forest website. forestdh.com/new-customer-forms.



FIND A DISTRIBUTOR

Buying from a local distributor may save you shipping time and provide better pricing. Need to find a distributor of Forest products? If so, scan this code to find a distributor in your area. forestdh.com/find-a-distributor

TO GET A QUOTE OR TO PLACE AN ORDER

We only accept orders in writing, not by phone. Please e-mail your customer service representative or customerservice@forestdh.com with your order information.

QUESTIONS ON AN ORDER

E-mail or call with your sales order number and we will be happy to help! Our office is open M-F, 8:30 am - 5:30 pm Eastern Time.
P: 678-721-0004
E: sales@forestdh.com

RETURNS, WARRANTY & CARE

FREIGHT/SHIPPING

Orders will be shipped via the most economical way. Freight charges will be added to invoice. The Forest Drapery Hardware Freight Policy is available online at forestdh.com/new-customer-forms.

RETURNS

All returns must be approved prior to returning by requesting an RGA authorization number. A 25% restocking fee will be applied. No returns accepted after 30 days of receipt of order or on custom orders.

PAYMENT

We accept Visa, Mastercard, American Express & Discover Card. Our invoice price is for check payment. We reserve the right to add a convenience fee for credit card payments. Credit is available upon submittal and approval of a credit application.

SHORTAGES/DAMAGES

Immediately upon receipt, your order should be inspected for shortages, damages, and to insure that there is no concealed damage from shipping. Claims on damages or shortages must be made within 3 days. Please note on the Bill of Lading if there is any possibility of damage. If your driver requires a digital signature, please request an EXCEPTION NUMBER from the driver before signing. Black marks, holes, open ends, over-boxing, re-taping, torn boxes etc., constitutes damage or possible shortage. No concealed damage claims will be filed as they are automatically denied by all carriers. You will be responsible for damaged freight not properly noted on delivery receipt. Our policy is that we replace damaged products per the original order and ship via the original carrier. If your order is damaged in shipping, carriers require that ALL packing materials be kept in order for a representative to inspect the goods. You will be billed for any replacement cost if a freight claim is denied. Replacements for undelivered goods will be sent after freight company has had a reasonable time to deliver order.

WARRANTY

Forest Drapery Tracks are warranted for 10 years. Forest Motors are warranted for 10 years with the exception of the Forest Lithium Battery Tubular Motor for RBS which is warranted for 1 year. Forest Roller Shades are warranted for 1 year. Warranties do not apply to wear resulting from normal usage, damage from mishandling, alterations from original state, abuse, or exposure due to climate conditions over which we have no control. The Tavira collection is the only category warranted for outdoor use, 1 year. Forest Drapery Hardware does not cover the shipping costs for the return or replacement of warranty items.

CARE

Products can be cleaned with a damp cloth. Do not use any type of cleaner or solvent.

APPENDIX

T&C | ORDERING INFORMATION | RETURNS, WARRANTY & CARE | **CARRIER COUNTS** | PRODUCT SUPPORT | SALES AIDS

RIPPLEFOLD CARRIER COUNTS

FOR OVERLAP MASTERS

No. of Full Spaces Required	Fabric Width Hemmed	Panel Coverage 120% Fullness	Panel Coverage 100% Fullness	Panel Coverage 80% Fullness	Panel Coverage 60% Fullness	* No. of Carriers
7	35 1/2	11-14	12-16	14-17	14-19	8
9	44	15-18	17-20	18-22	20-24	10
11	52 1/2	19-21	21-24	23-27	25-30	12
13	61	22-25	25-28	28-32	31-35	14
15	69 1/2	26-29	29-32	33-36	36-40	16
17	78	30-33	33-37	37-41	41-45	18
19	86 1/2	34-36	38-41	42-46	46-51	20
21	95	37-40	42-45	47-51	52-56	22
23	103 1/2	41-44	46-50	52-55	57-61	24
25	112	45-48	51-54	56-60	62-66	26
27	120 1/2	49-51	55-58	61-65	67-72	28
29	129	52-55	59-62	66-70	73-77	30
31	137 1/2	56-59	63-66	71-74	78-82	32
33	146	60-63	67-71	75-79	83-87	34
35	154 1/2	64-66	72-75	80-84	88-93	36
37	163	67-70	76-79	85-89	94-98	38
39	171 1/2	71-74	80-84	90-93	99-103	40
41	180	75-78	85-88	94-98	104-108	42
43	188 1/2	79-81	89-92	99-103	109-114	44
45	197	82-85	93-96	104-108	115-119	46
47	205 1/2	86-89	97-101	109-112	120-124	48
49	214	90-93	102-105	113-117	125-129	50
51	222 1/2	94-96	106-109	118-122	130-135	52
53	231	97-100	110-113	123-127	136-140	54
55	239 1/2	101-104	114-118	128-131	141-145	56

No. of Full Spaces Required	Fabric Width Hemmed	Panel Coverage 120% Fullness	Panel Coverage 100% Fullness	Panel Coverage 80% Fullness	Panel Coverage 60% Fullness	* No. of Carriers
57	248	105-108	119-122	132-136	146-150	58
59	256 1/2	109-111	123-126	137-141	151-156	60
61	265	112-115	127-130	142-146	157-161	62
63	273 1/2	116-119	131-136	147-150	162-166	64
65	282	120-123	137-139	151-155	167-171	66
67	290 1/2	124-126	140-143	156-160	172-176	68
69	299	127-130	144-147	161-165	177-182	70
71	307 1/2	131-134	148-152	166-169	183-187	72
73	316	135-138	153-156	170-174	188-192	74
75	324 1/2	139-141	157-160	175-179		76
77	333	142-145	161-164	180-184		78
79	341 1/2	146-149	165-168	185-188		80
81	350	150-153	169-173	189-193		82
83	358 1/2	154-156	174-177			84
85	367	157-160	178-181			86
87	375 1/2	161-164	182-186			88
89	384	165-168	187-190			90
91	392 1/2	169-171				92
93	401	172-175				94
95	409 1/2	176-179				96
97	418	180-183				98
99	426 1/2	184-186				100
101	435	187-190				102

* Includes one carrier (button position only) for attachment to master.

APPENDIX

T&C | ORDERING INFORMATION | RETURNS, WARRANTY & CARE | **CARRIER COUNTS** | PRODUCT SUPPORT | SALES AIDS

RIPPLEFOLD CARRIER COUNTS

FOR BUTT MASTERS

No. of Full Spaces Required	Fabric Width Hemmed	Panel Coverage 120% Fullness	Panel Coverage 100% Fullness	Panel Coverage 80% Fullness	Panel Coverage 60% Fullness	* No. of Carriers
7	34	13-13	13-14	13-16	16-18	8
9	42 1/2	14-16	15-19	17-21	19-23	10
11	51	17-20	20-23	22-26	24-28	12
13	59 1/2	21-24	24-27	27-30	29-34	14
15	68	25-28	28-31	31-35	35-39	16
17	76 1/2	29-31	32-36	36-40	40-44	18
19	85	32-35	37-40	41-45	45-49	20
21	93 1/2	36-39	41-44	46-49	50-55	22
23	102	40-43	45-48	50-54	56-60	24
25	110 1/2	44-46	49-53	55-59	61-65	26
27	119	47-50	54-57	60-64	66-70	28
29	127 1/2	51-54	58-61	65-68	71-76	30
31	136	55-58	62-65	69-73	77-81	32
33	144 1/2	59-61	66-70	74-78	82-86	34
35	153	62-65	71-74	79-83	87-91	36
37	161 1/2	66-69	75-78	84-87	92-97	38
39	170	70-73	79-82	88-92	98-102	40
41	178 1/2	74-76	83-87	93-97	103-107	42
43	187	77-80	88-91	98-102	108-112	44
45	195	81-84	92-95	103-106	113-118	46
47	204	85-88	96-99	107-111	119-123	48
49	212 1/2	89-91	100-104	112-116	124-128	50
51	221	92-95	105-108	117-121	129-133	52
53	229 1/2	96-99	109-112	122-125	134-139	54
55	238	100-103	113-116	126-130	140-144	56

No. of Full Spaces Required	Fabric Width Hemmed	Panel Coverage 120% Fullness	Panel Coverage 100% Fullness	Panel Coverage 80% Fullness	Panel Coverage 60% Fullness	* No. of Carriers
57	246 1/2	104-106	117-121	131-135	145-149	58
59	255	107-110	122-125	136-140	150-154	60
61	263 1/2	111-114	126-129	141-144	155-160	62
63	272	115-118	130-133	145-149	161-165	64
65	280 1/2	119-121	134-138	150-154	166-170	66
67	289	122-125	139-142	155-159	171-175	68
69	297 1/2	126-129	143-146	160-163	176-181	70
71	306	130-133	147-150	164-168	182-186	72
73	314 1/2	134-136	151-155	169-173	187-191	74
75	323	137-140	156-159	174-178	192-196	76
77	331 1/2	141-144	160-163	179-182		78
79	340	145-148	164-167	183-187		80
81	348 1/2	149-151	168-172	188-192		82
83	357	152-155	173-176	193-197		84
85	365 1/2	156-159	177-180			86
87	374	160-163	181-184			88
89	382 1/2	164-166	185-189			90
91	391	167-170	190-193			92
93	399 1/2	171-174				94
95	408	175-178				96
97	416 1/2	179-181				98
99	425	182-185				100
101	433 1/2	186-189				102
103	442	190-193				104

* Includes one carrier (button position only) for attachment to master.

APPENDIX

T&C | ORDERING INFORMATION | RETURNS, WARRANTY & CARE | CARRIER COUNTS | **PRODUCT SUPPORT** | SALES TOOLS

PRODUCT SUPPORT



RETAIL PRICE GUIDE

PRODUCT CATALOGS

The Forest product catalog contains over 100 pages of product available in our Cartersville, Georgia warehouse. Get a catalog in print or online.....





FOREST WEBSITE – FORESTDH.COM

Catalog & Spec Sheets
Assembly & Installation Instructions
Technical Manuals
Trade Show Schedule



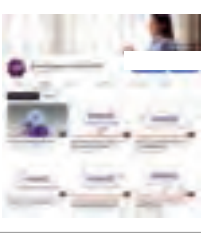

FOREST CHANNEL

Programming, Assembly, Installation, and Tips & Tricks





PRODUCT TRAINING

Forest sales managers will train you and your customers at your facility or ours. Call today to schedule a group presentation, lunch & learn, or an open house – 678-721-0004.



CHILD SAFETY

All Forest custom assembled products containing cords meet ANSI/WCMA A100.1-2018 child safety standards and include a tension device and a warning label like the one to the left.

APPENDIX

T&C | ORDERING INFORMATION | RETURNS, WARRANTY & CARE | CARRIER COUNTS | PRODUCT SUPPORT | **SALES TOOLS**

SALES TOOLS



WALL DISPLAY

Display a comprehensive set of Forest hardware in your showroom. Set includes a logo board at the top plus ten hardware samples. 25 1/4" wide by 53 1/8" high. Pair of rails for wall mounting are included. \$250.00/set



TABLE TOP DISPLAY

Show off the brilliant finishes and quality craftsmanship of Forest hardware in your showroom. \$250.00 ea.



FINISH SELECTOR CLUTCH CASE

This portable case allows you to easily take all of our finishes into your next meeting. Or, grab only the collections you need in a handy clutch format. \$250.00 ea.

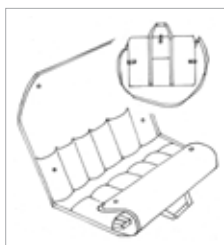

SAMPLES CARRY BAG

This portable fabric case houses a sampling of hardware to take into your client meeting. \$250.00 ea.



ROLLER SHADE FABRIC SWATCH CARD

The Forest roller shade fabric swatch card allows you to see and feel our stock fabrics email sales@forestdh.com



FOREST DRAPERY HARDWARE

2500 Donn Drive
Cartersville, GA 30120
United States
T 678-721-0004
E sales@forestdh.com
W www.forestdh.com

For a distributor in your area
go to www.forestdh.com
or call 678-721-0004.

