

Yarnspirations™



MAKE THIS

## BLACK CAT TUFTED RUG



Black



White



CRAFT | SKILL LEVEL: **BEGINNER**





# MAKE THIS

## WHAT YOU’LL NEED



## TOOLS

- Rug tufting tool.
- 20" x 30" [51 x 76 cm] tufting frame.
- 26" x 36" [66 x 91.5 cm] gridded tufting cloth.
- 15½" x 24½" [39.5 x 62 cm] project backing fabric.
- Tufting carving sheers.
- 7.6 fl oz/225 ml container white all-purpose glue.
- Paint brush.
- Pencil or felt tip marker
- Scissors
- Tweezers
- Tape
- Hot glue
- Tape measure



- **Red Heart® Super Saver®**  
(35.3 oz/1000 g; 1855 yds/1696 m)

## COLORS

### Quantity

- **Contrast A** Black (0312)  
1 ball or 257 yds/235 m
- **Contrast B** White (0311)  
1 ball or 397 yds/363 m



**ABBREVIATIONS**

**Approx** =                      **RS** = Right side  
Approximately                **WS** = Wrong side

# MAKE THIS

## INSTRUCTIONS

## MEASUREMENTS

Approx 15½" x 24½" [39.5 x 62 cm].



**ABBREVIATIONS**

**Approx** =                      **RS** = Right side  
 Approximately                **WS** = Wrong side

**MAKE THIS****INSTRUCTIONS**

1. Set up tufting frame as per manufacturer's instructions.

2. Stretch tufting cloth as per manufacturer's instructions using grid lines to align cloth and making sure cloth is as tight as possible (like a drum). Continue to tighten cloth throughout the process to ensure it remains very taut.



3. Transfer design to cloth. Print pattern to scale (see pages 10 to 15), taping together sheets as necessary, and cut out design. Center and trace  $15\frac{1}{2}$ " x  $24\frac{1}{2}$ " [39.5 x 62 cm] rectangle at front of cloth. Cut out face of cat. Center design within rectangle and trace design to front of cloth.





**ABBREVIATIONS**

**Approx** =                      **RS** = Right side  
Approximately                **WS** = Wrong side

# MAKE THIS

## INSTRUCTIONS

4. Re-center cat face design at back of cloth. Secure printed pattern in place with tape. Place frame in front of bright light source or sunny window and trace pattern onto front of cloth with pencil or felt tip marker. Remove printed pattern.

**Note:** RS of Rug is actually back of your cloth, so images traced will appear reversed in the finished project.

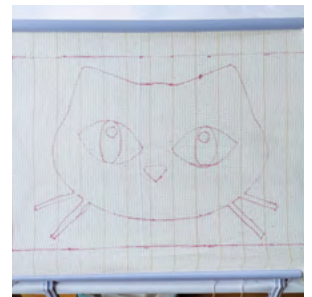

5. With A, thread tufting tool as per manufacturer's instructions, being sure tool is set to cut-pile. You will typically need to thread 2 strands of yarn through machine to ensure the finished Rug appears lush and full.



ABBREVIATIONS	
<b>Approx</b> =	<b>RS</b> = Right side
Approximately	<b>WS</b> = Wrong side

# MAKE THIS

## INSTRUCTIONS

6. Holding tufting tool perpendicular to your work with head/guide pushed firmly against your cloth, start tufting with main outlines of design. Pull trigger and move slowly to outline details.

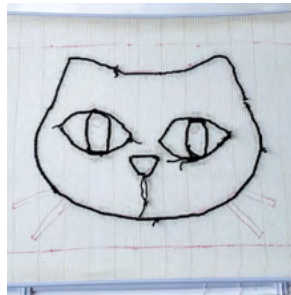

7. With A, fill in outline, working in tight vertical rows. As you get to the end of a row, simply move tufting tool back to bottom of outline and begin another vertical row next to the last until area is completely filled in.



8. With B, repeat Steps 5 to 7.

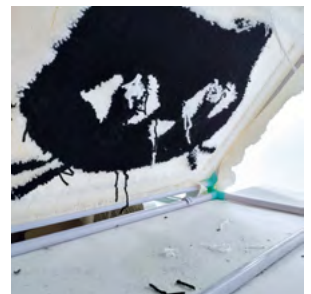



ABBREVIATIONS	
<b>Approx</b> =	<b>RS</b> = Right side
Approximately	<b>WS</b> = Wrong side

# MAKE THIS

## INSTRUCTIONS

9. Trim excess strands of yarn from back surface of your work.



10. Secure yarn in place on WS using white glue and brush. Use brush to spread an even coating of white glue on back surface of Rug, being sure to saturate every strand. Allow to dry fully before continuing with next step.



11. Once fully dry, remove cloth from frame and prepare to trim.



12. With tufting carving sheers and scissors, trim entire front surface of Rug to even out all yarn strands.

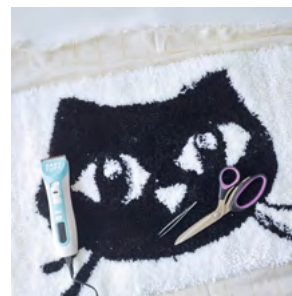



ABBREVIATIONS	
<b>Approx</b> =	<b>RS</b> = Right side
Approximately	<b>WS</b> = Wrong side

# MAKE THIS

## INSTRUCTIONS

13. With tweezers, clean up edges of design by moving each strand into position to ensure crisp lines.



14. With tufting carving sheers, further refine edges and lines by trimming strands at a 45-degree angle around each color separation, working first to trim one shade, and then at a 45-degree angle to trim second shade, resulting in 'v' grooved defined lines between each color.



15. Trim tufting cloth around design leaving a 1" [2.5 cm] border.







ABBREVIATIONS	
<b>Approx</b> =	<b>RS</b> = Right side
Approximately	<b>WS</b> = Wrong side

# MAKE THIS

## INSTRUCTIONS

16. Using hot glue, fold border of cloth to back of Rug and secure in place around all edges, trimming away excess fabric at corners.



17. Using hot glue, secure backing fabric to back of rug, enclosing tufting cloth to create clean edges.

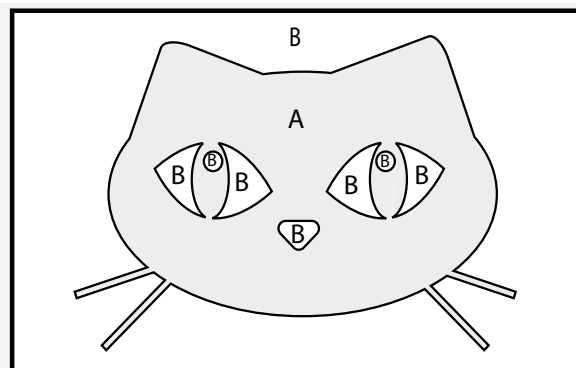

*We love seeing your makes! Share your photos using #YARNSPO and tag us @yarnspirations on Instagram or find us on Facebook.*



**ABBREVIATIONS**  
**Approx** =                      **RS** = Right side  
Approximately                **WS** = Wrong side

# MAKE THIS

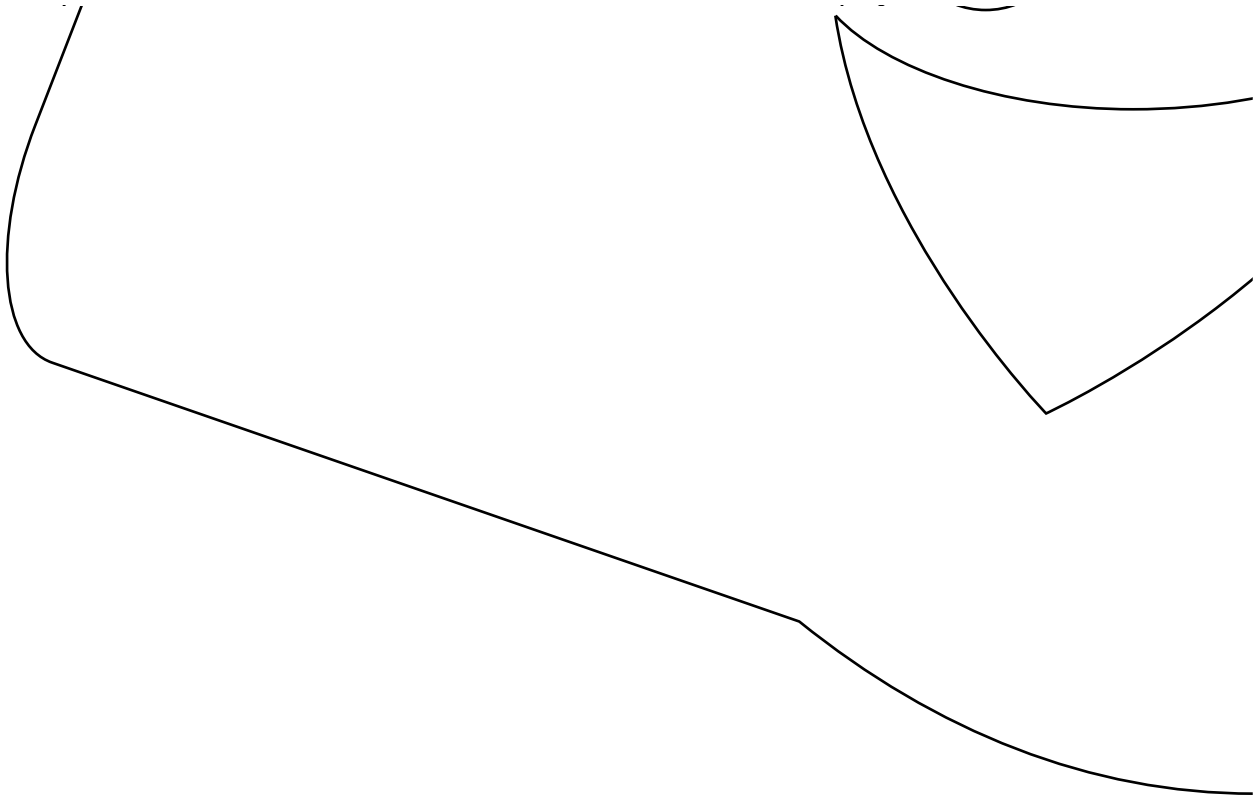

# 1

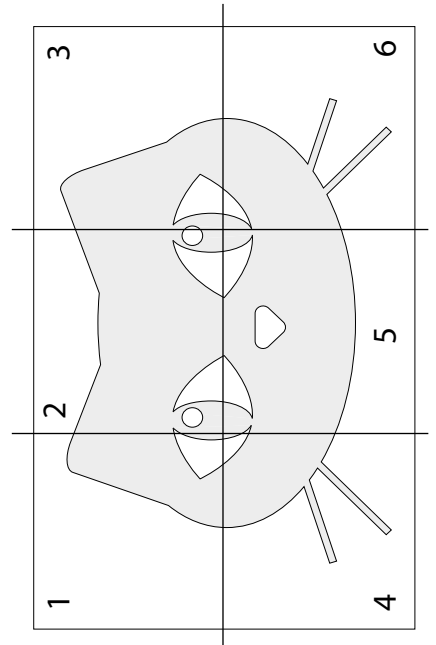



# MAKE THIS

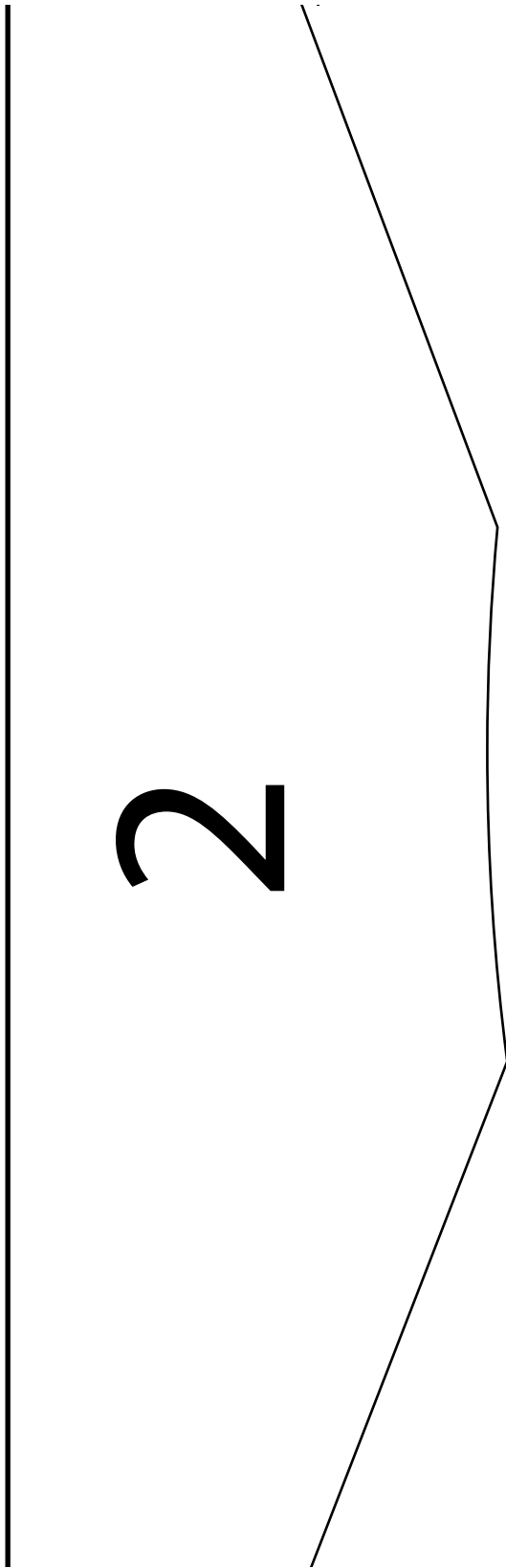

**ABBREVIATIONS**  
**Approx** =                      **RS** = Right side  
Approximately                **WS** = Wrong side

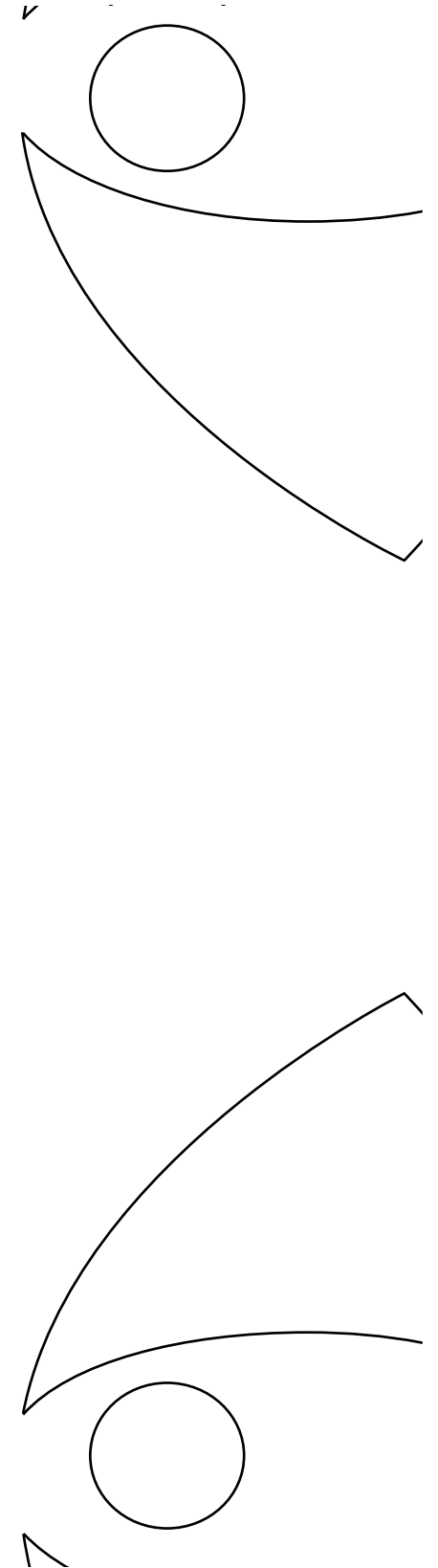



ABBREVIATIONS	
<b>Approx</b> =	<b>RS</b> = Right side
Approximately	<b>WS</b> = Wrong side

# MAKE THIS

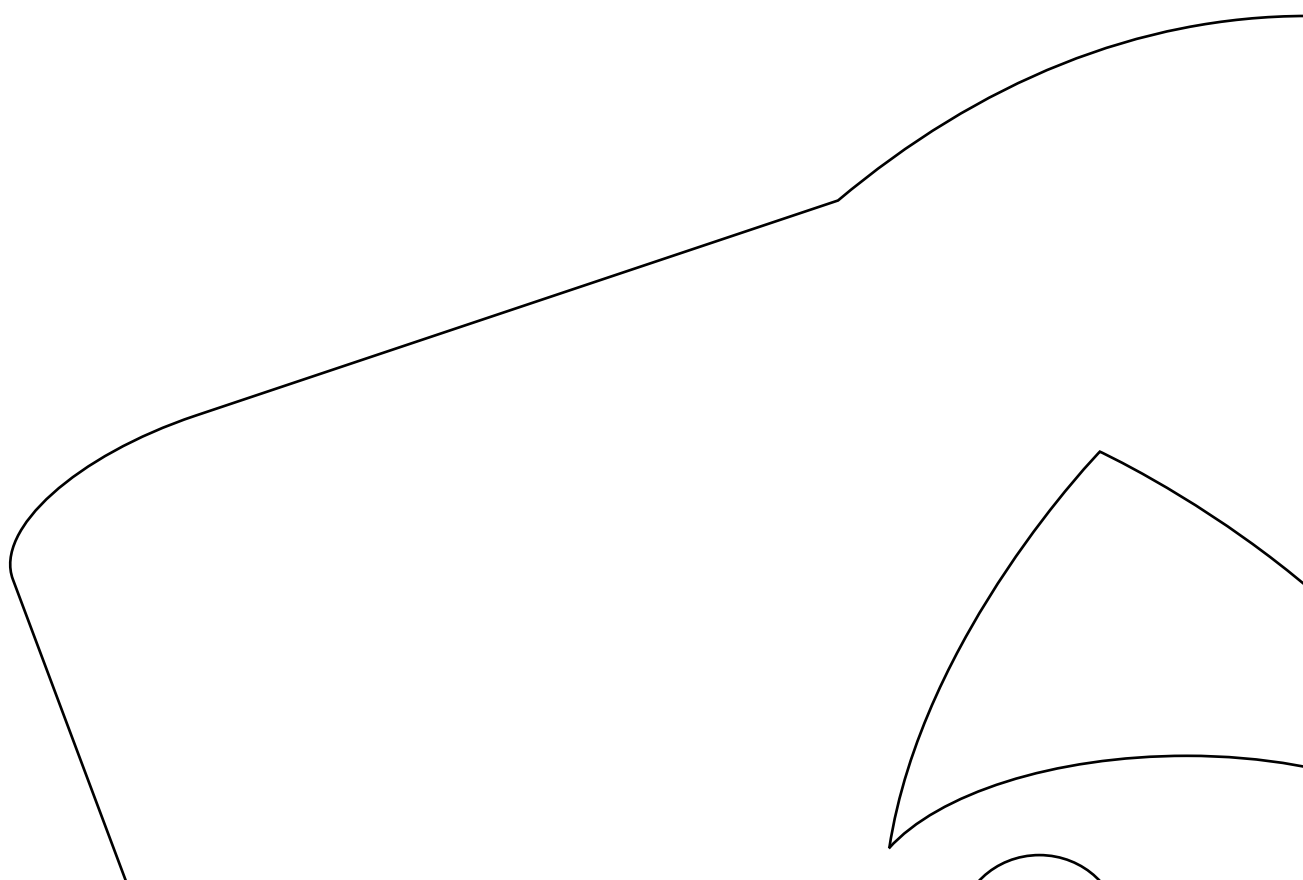





# MAKE THIS

ABBREVIATIONS	
<b>Approx</b> =	<b>RS</b> = Right side
Approximately	<b>WS</b> = Wrong side

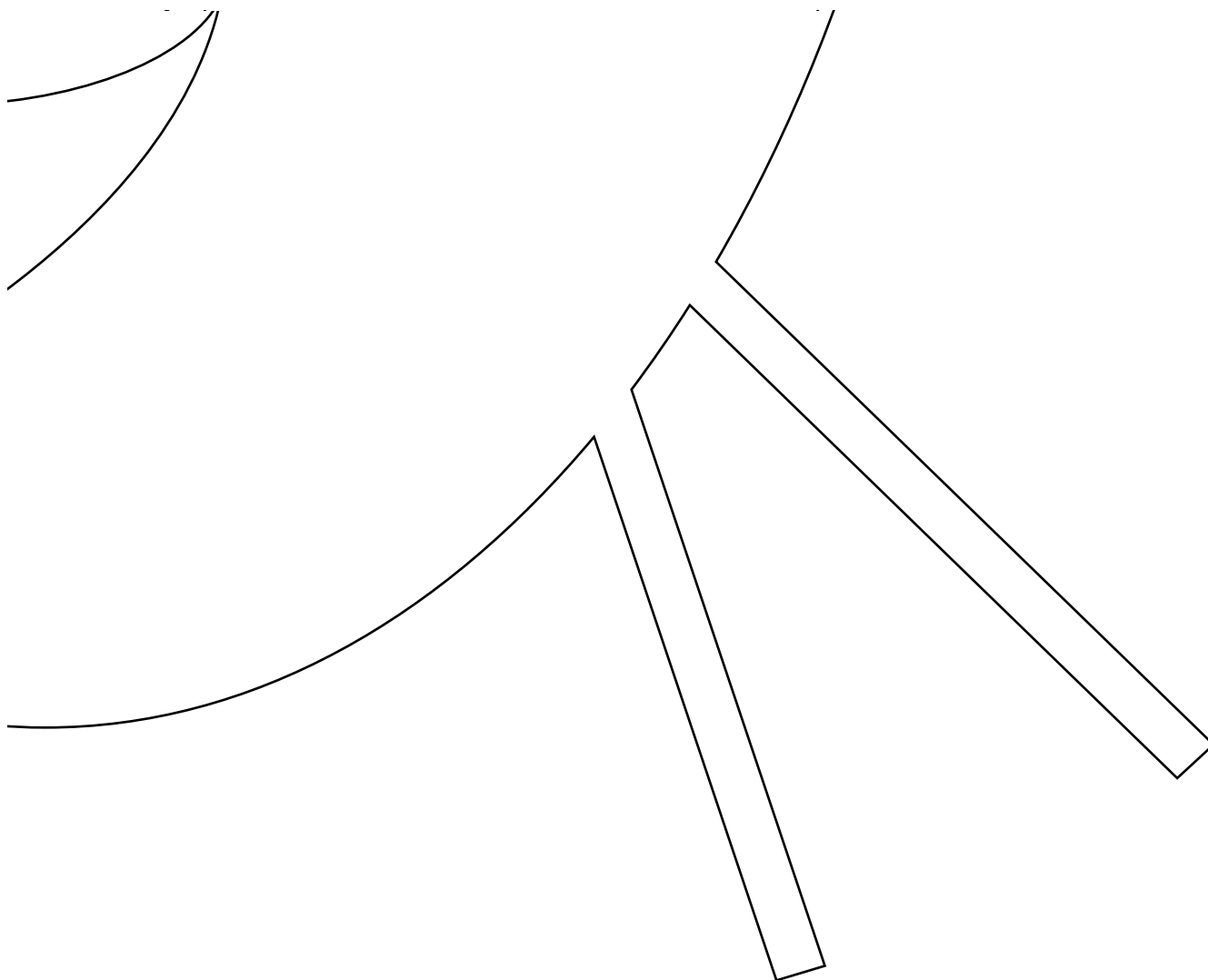



# MAKE THIS

ABBREVIATIONS	
<b>Approx</b> =	<b>RS</b> = Right side
Approximately	<b>WS</b> = Wrong side

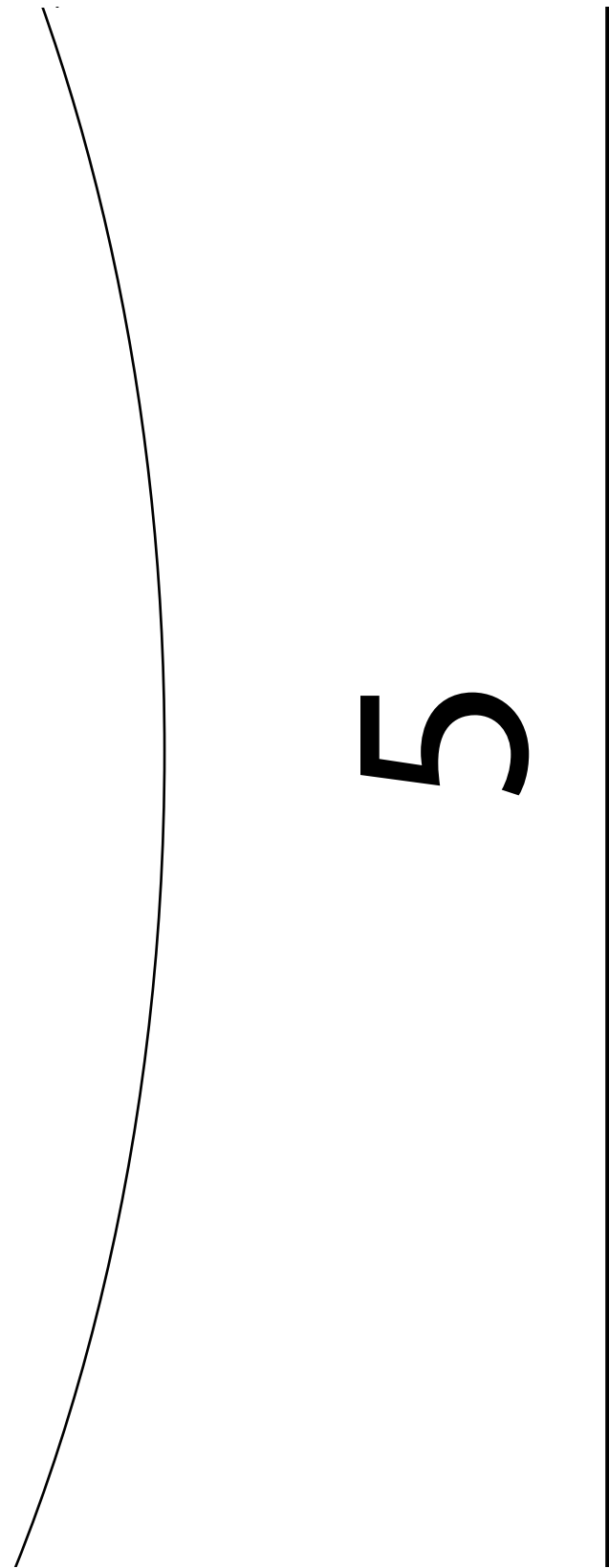
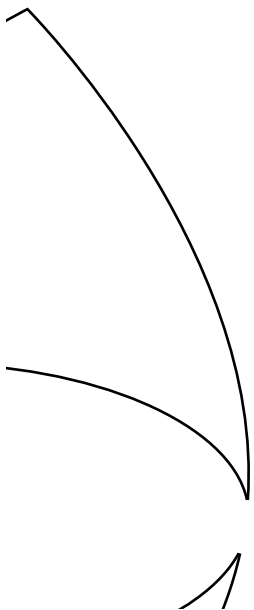
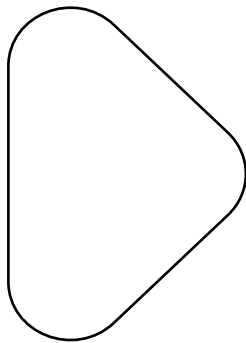
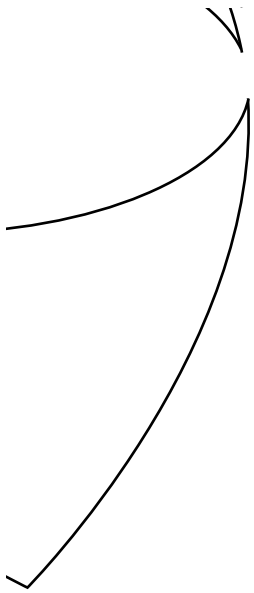



ABBREVIATIONS	
<b>Approx</b> =	<b>RS</b> = Right side
Approximately	<b>WS</b> = Wrong side

# MAKE THIS

