

**1**

Using a hole saw, drill a neat hole 32mm in diameter through the hob bench.

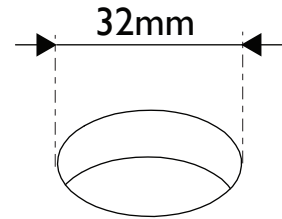

**2**

Fit O-Ring to the groove in the base of the Mixer Body.

Feed the threaded end of the Mixer Body through the hole.

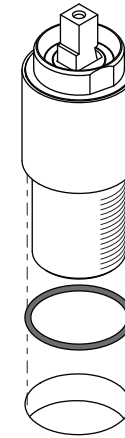

**3**

Feed Hoses through the bottom end of the Locknut.

Connect Hoses to Mixer Body as shown.

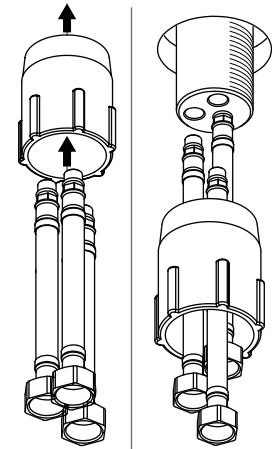
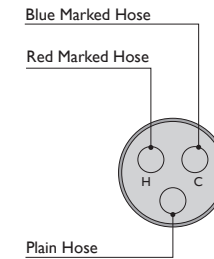

**4**

Place Washer over Mixer Body and screw Locknut in place.

Tighten firmly.

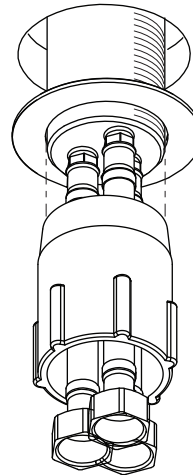

**5**

Fit Dress Ring over the Mixer Body.

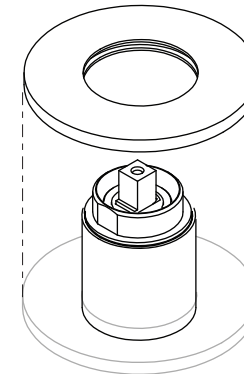

**6**

Place Handle onto Mixer Body.

Using the allen key provided, firmly tighten Grub Screw.

Firmly push in Screw Cap.

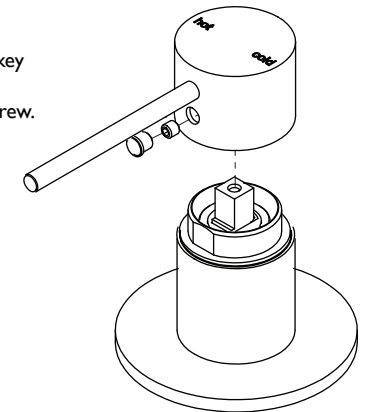

recommended working pressure  
**150-500 KPa**

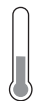

maximum hot water temperature  
**75 degrees**

**NOTE:**

- If the pressure exceeds or is likely to exceed 550kpa, an approved pressure limiting device must be installed.
  - Flush out all pipe work prior to installation.
  - If the water temperature exceeds 75°C, an approved tempering valve must be fitted.
  - Installation should comply with Australian standard AS3500.1 or relevant local authority requirements.
- Showers may not be suitable for use within:
- Gravity-fed water systems
  - Some instantaneous hot water systems; or

- Pressure supply less than 150kPa;

NOTE: The 500kPa maximum water supply pressure does not apply to fire service outlets.

Failure to comply with the above may void all warranties.

**WARRANTY:**

Please refer to the full warranty statement enclosed with the product before installing. Or visit [www.phoenixtapware.com.au](http://www.phoenixtapware.com.au) to download a copy.

**MAINTENANCE AND CARE:**

- Products should be cleaned with mild liquid detergent or soap and water.
- Do not use cream cleaners or citrus based cleaning products, as they are abrasive.
- Use of unsuitable cleaning agents may damage the surface. Any damage caused in this way will not be covered by warranty.

**DISCLAIMER:**

While we aim to ensure the specifications shown are correct at the time of printing, Phoenix Tapware reserves the right to make modifications without prior notice. Always use the physical product measurements for mark-ups and roughing-in as the line drawing shown may differ from the actual product over time.

\*All measurements are shown in millimeters.