

MOUNTING KIT

8 x Screw Toggles

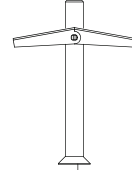

recommended working pressure
150-500 KPa
maximum hot water temperature
75 degrees

- NOTE:**
- If the pressure exceeds or is likely to exceed 550kpa, an approved pressure limiting device must be installed.
 - Flush out all pipe work prior to installation.
 - If the water temperature exceeds 75°C, an approved tempering valve must be fitted.
 - Installation should comply with Australian standard AS3500.1 or relevant local authority requirements.
 - Showers may not be suitable for use within:
 - Gravity-fed water systems
 - Some instantaneous hot water systems; or

RECOMMENDED INSTALLATION

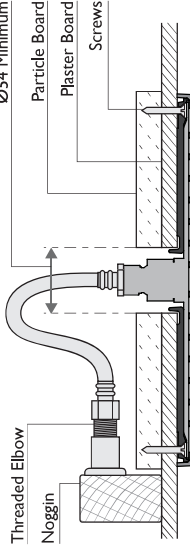

ALTERNATIVE INSTALLATION

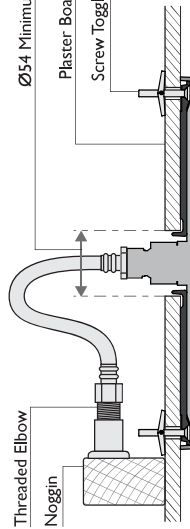

- If cavity above the shower is accessible, it is recommended that a sheet of Particle Board is installed above the Ceiling Sheeting.
- Cut a centre hole, minimum 54mm diameter.
- A larger hole can be cut to allow hose installation from underneath.
- Fasten bracket using appropriate countersunk screws.

- Cut a centre hole, minimum 54mm diameter.
- A larger hole can be cut to allow hose installation from underneath.
- Use the Bracket to mark Screw Toggle holes.
- Drill 8 x Ø12mm through-holes for the Screw Toggles.
- Fasten bracket.

2

- Feed Hose through the centre hole in the Bracket.
- Centre the bracket using the drilled hole.
- Fix bracket to ceiling using appropriate countersunk screws.

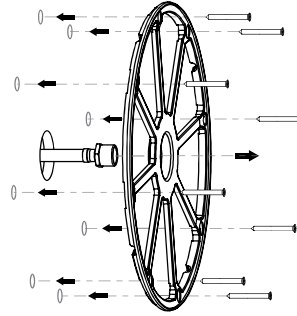

NOTE
Use Toggle Screws for alternative installation.

3

- Insert Rubber Washers and Flow Controller into Shower Rose, as shown.
- Screw Shower Rose onto the Hose and firmly tighten using a spanner.
- CHECK AND TEST FOR LEAKS

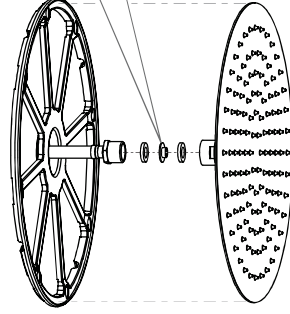

NOTE
Flow Direction

1

- Apply Teflon Tape to the Threaded Elbow.

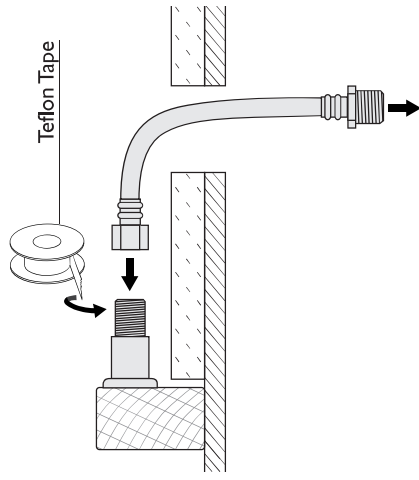

4

- Fit Shower Rose into the Bracket.
- Retain the Shower Rose by pushing the Retaining Ring onto the Bracket.
- Ensure the Retaining Ring is fully installed by firmly pressing all the way around the ring.

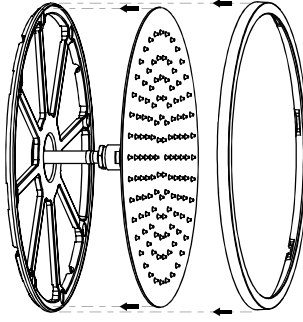

DISCLAIMER:

While we aim to ensure the specifications shown are correct at the time of printing, Phoenix Tapware reserves the right to make modifications without prior notice. Always use the physical product measurements for mark-ups and roughing-in as the line drawing shown may differ from the actual product over time.

*All measurements are shown in millimeters.

(03) 9780 4200
www.phoenixtapware.com.au

MAINTENANCE AND CARE:

- Products should be cleaned with mild liquid detergent or soap and water.
- Do not use cream cleaners or citrus based cleaning products, as they are abrasive.
- Use of unsuitable cleaning agents may damage the surface. Any damage caused in this way will not be covered by warranty.

- Pressure supply less than 150kPa.
- NOTE: The 500kPa maximum water supply pressure does not apply to fire service outlets.

Failure to comply with the above may void all warranties.

WARRANTY:

Please refer to the full warranty statement enclosed with the product before installing. Or visit www.phoenixtapware.com.au to download a copy.