

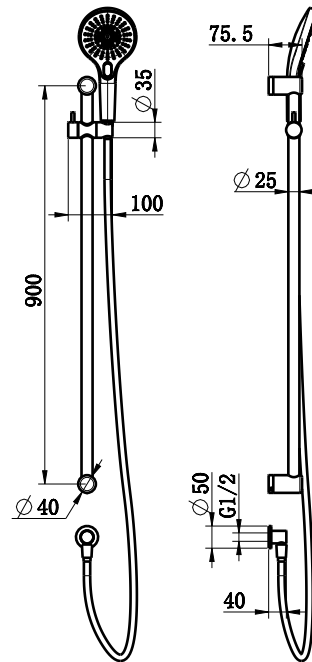





Mecca Care 25MM Grab Rail And Adjustable Shower Rail Set 900mm



SKU

	CHROME NRCS004CH		MATTE BLACK NRCS004MB
	BRUSHED NICKEL NRCS004BN		GUN METAL NRCS004GM
	BRUSHED GOLD NRCS004BG		BRUSHED BRONZE NRCS004BZ

Features

1. Australian owned and designed.
2. 1.5m PVC hose.
3. The rail can be shortened during installation to suit your bathroom.
4. 25mm diameter rails are suitable for heavy duty towel rails and smaller hands, in non-DDA bathrooms.
5. Gun metal, brushed gold and brushed bronze colours are PVD coated for long term durability.
6. WELS rating is 3 STAR 9L/MIN.
7. WATERMARK license is WM-060093.

WARNING:

These rails are designed to be mounted onto wall studs or masonry walls. Installation is recommended to be completed by qualified trades person who complies with the AS 1428.1-2009 design for access and mobility standard.

It is recommended rail location is determined by a qualified occupational therapist or trained professional to the AS 1428.1-2009 standard. Correct installation is required to ensure safe, long term operation. Incorrect mounting can result in reduced capacity of the rail which can result in injury to user and damage to the wall.



MECCA CARE
ASSISTED LIVING 25MM



1. Put teflon tape onto outlet thread.

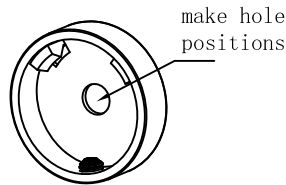

4. Locate wall studs, install into at least one stud.
Place wall seal/mounting bracket on wall at correct height over centre of stud and mark hole positions on wall.

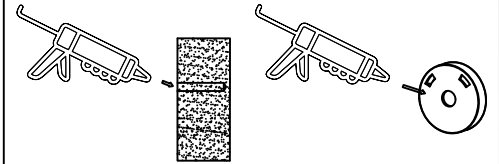

6. Apply small amount of silicon to mounting bracket and wall in and around the screw holes.

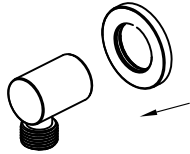

2. Slide plate onto elbow.

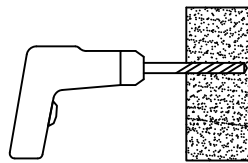

5. Drill pilot holes into wall stud approximately 60mm deep to suit mounting screws (and wall plugs if required).

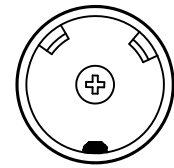

7. Install mounting brackets by screwing onto wall.

Tip: Use appropriate mounting screws for the wall stud material, supplied screws are for timber wall studs.

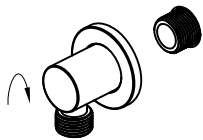

3. Screw elbow onto outlet.

Tip: 4mm hole for screws into timber or 10mm hole for wall plugs.

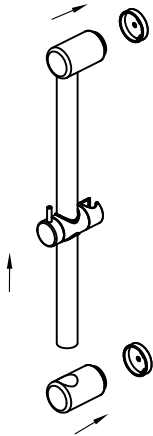

8. Slide the shower slider onto rail, then slide rail tubes into end brackets and push onto wall brackets, refer to above picture.

Tip: Rail length can be cut down to a smaller size, simply use an angle grinder, hacksaw or pipe cutter then deburr the end with a file or grinder and reinsert into the end bracket.

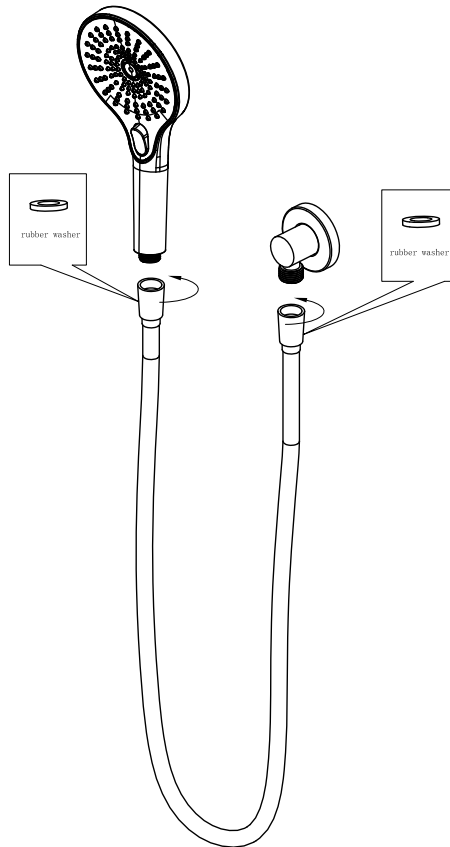

10. Connect hand shower and elbow by shower hose.

Tip: There are two rubber washer in the shower hose.

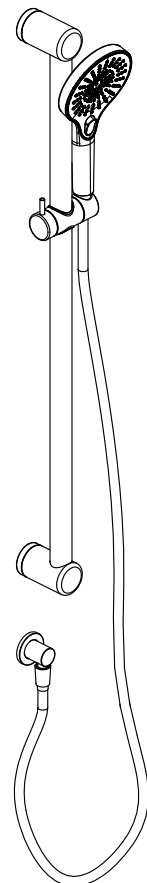

11. Test and check for leaks.

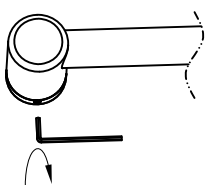

9. Tighten grub screws with allen key.

Tip: If rail rattles, loosen end bracket, twist slightly and tighten.