

MZ0402 HAND SHOWER RAIL

meir®



FEATURES

- Refer to the Meir website for warranty terms & conditions, and available finishes
- Flow rate **8 L p/m** at 3 bar pressure.
- European components and cartridge
- Solid brass construction
- Box Weight 2 kg
- 68mm long 1/2" threaded adapter included for non-AU regions only

CARE

- Do not install tapware using any form of acetone silicones.
- Do not apply physical items (such as tools) directly to product.
- Never use house-hold or commercial detergents, citrus based cleaners, or abrasive cleaners.
- Clean using a mild washing soap solution rinsed, and dry with a soft cloth.
- Check for any product defects before installation.
- Refer to the installation manual for correct installation.

CREDENTIALS

- Watermark AS/NZS3718WMKA25013
- 3-star WELS rated
- 9 Litres p/minute
- WELS registration No: S17606

SPECIFICATIONS

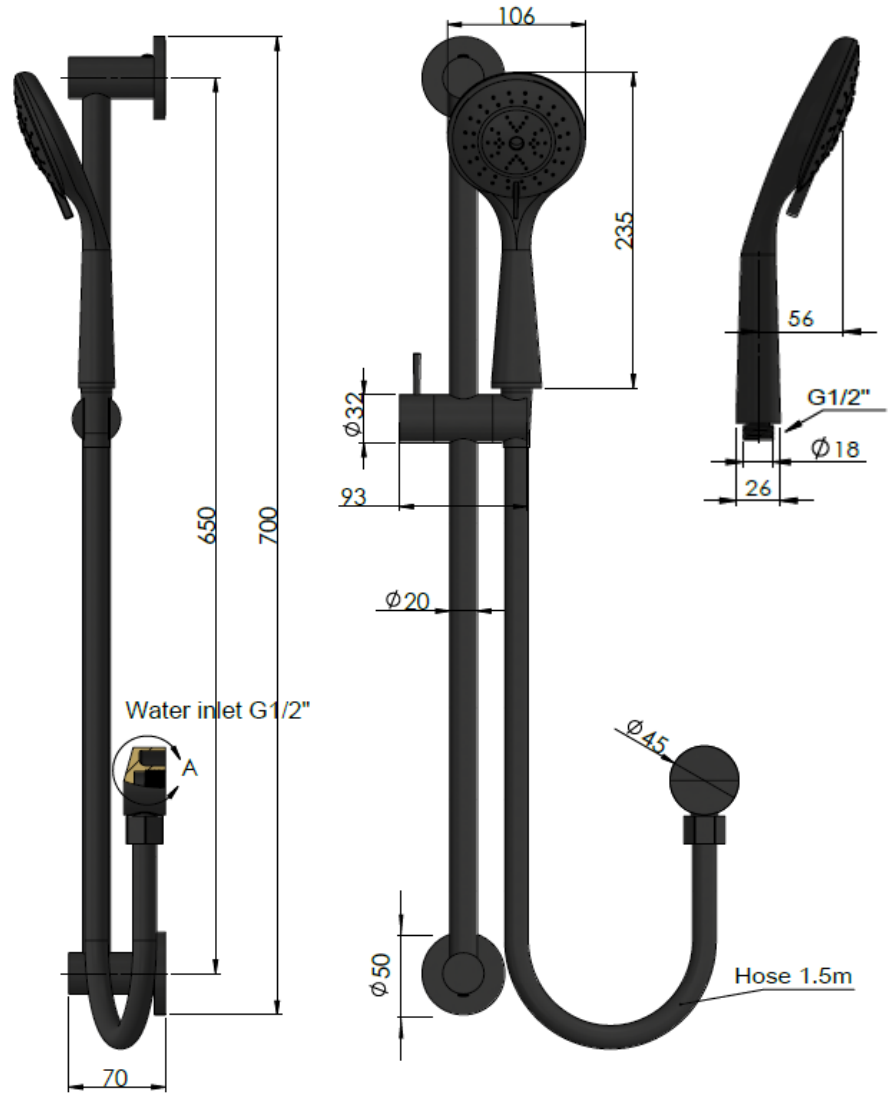

FLOW RATE GRAPH

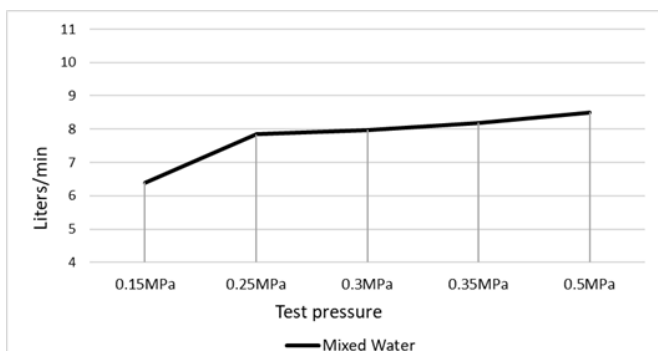

TOLERANCES

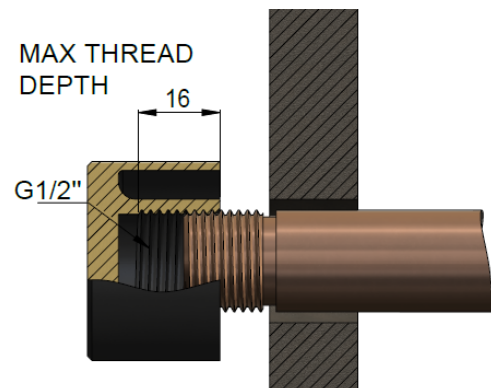

MZ0402

HAND SHOWER RAIL

meir.®

EXPLODED VIEW

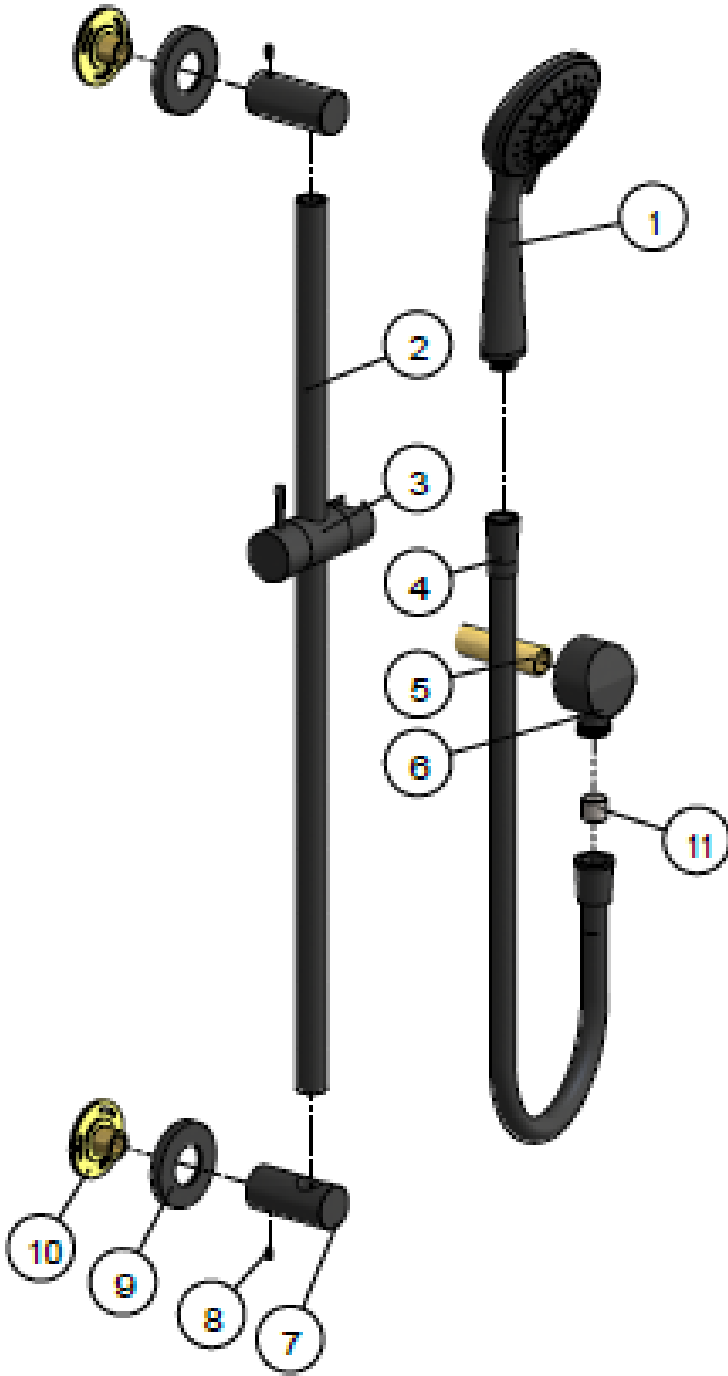

No	Part Name
1	Hand Shower
2	Shower Rail
3	Shower Bracket
4	Shower Hose
5	Threaded Adapter
6	Elbow
7	Base
8	Screw
9	Back Plate
10	Mounting Base
11	Check Valve