

Kaya® ROUND ACCESSORY COVER PLATES

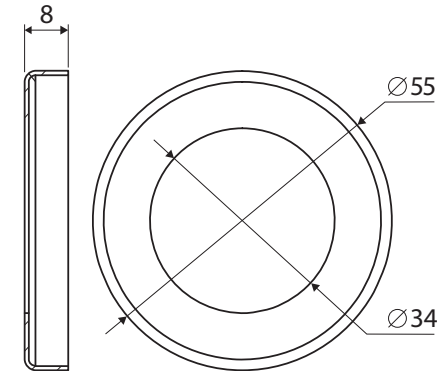

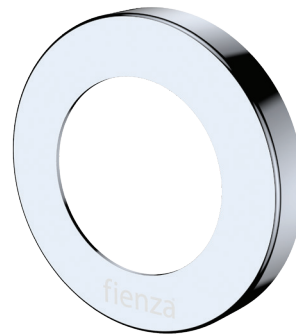



Features

- Designed to match the KAYA range of mixers, showers and bath outlets
- Made from stainless steel

Please Note: These products may have a visible Fienza or Watermark logo.



Available in

			
PVD Brushed Nickel 82800BN	Electroplated Chrome 82800	Electroplated Matte White 82800MW	Electroplated Matte Black 82800MB
			
	PVD Gun Metal 82800GM	PVD Brushed Copper 82800CO	PVD Urban Brass 82800UB

Cleaning & Care

- Regularly clean with mild soapy water using a microfibre cloth.
- In highly polluted or coastal locations, we recommend cleaning 2-3 times per week.
- Do not use harsh detergents, bleach, cream cleaners or citrus based cleaners. These substances are abrasive and will damage the surface.
- Do not use undue pressure and wipe in one direction only

While we aim to ensure specifications are correct at the time of publication, Fienza reserves the right to make modifications without prior notice. Physical colour may vary from image shown. All measurements are shown in millimetres. Always use physical product measurements for mark-ups and roughing-in as the technical drawing may differ from actual product received.