

Isabella

HEATED TOWEL RAIL

8277570



Concealed Wiring



Exposed Wiring

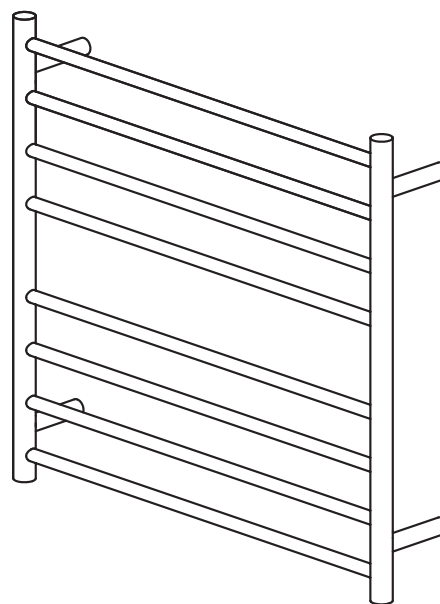

PLEASE READ THROUGH THIS INSTALLATION GUIDE CAREFULLY BEFORE INSTALLING THE PRODUCT. Check the product thoroughly for damage. Installation is acceptance of goods supplied and will void warranty. Ensure all items meet your building or plumbing requirements before installation.

Specifications

Please refer to fienza.com.au for the latest product specifications before installing.

Overall Width	750 mm
Overall Height	700 mm
Overall Depth	122 mm
Voltage	230V
Power	115W
IP Rating	IP55
Wiring Method	Concealed or exposed
Wiring Positions	Top and bottom; left and right

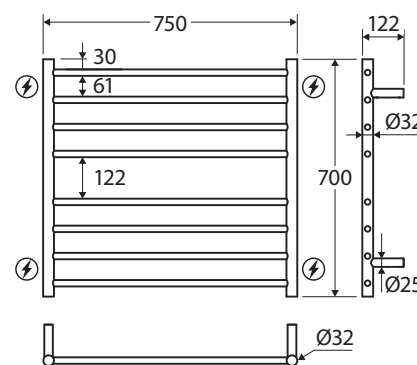

⚡ Wiring Positions

Overview

All Fienza Heated Towel Rails are manufactured to the following standards and specifications:

- AS/NZ 3000:2007
- SAA Approved
- Rated voltage – 230V
- IP Rating – IP55
- Touch temperature between 45°C and 50°C

This towel rail is designed for use in residential and hotel bathrooms and is intended for the purpose of drying towels. The towel rail **MUST** be installed as prescribed by a licensed tradesperson in accordance with local wiring rules and regulations, including the regulations covering installation of appliances and accessories in 'wet areas' such as bathrooms, showers and laundries. Installation should be in accordance with AS/NZS 3000:2007.

All installations must be carried out by a licensed tradesperson in accordance with all applicable Building, Plumbing and Electrical codes, and Federal, State, or Local Government Regulations in accordance with AS/NZS 3500 Plumbing & Drainage, AS/NZS 6400:2016 Water Efficient Products, and AS/NZS 3000:2007 Electrical standards for any installations to which these standards apply.

Safety Warnings & Information

As with any electrical appliance, you should be aware of basic safety precautions when using this heated towel rail. Please read these instructions carefully and file for future reference.

1. This appliance **MUST** be installed by a licenced electrician.
2. The towel rail should not be used for anything other than its intended use.
3. For safety protection, this electrical appliance relies on the earth being connected to a residential device.
4. Use this appliance only on the voltage specified on the rating label.
5. The towel rail will get slightly hotter than normal during warmer weather and when insulated by towels.
6. To avoid hazards for young children or infirmed persons, this appliance must be installed so that the lowest part of the rail is at least 600 mm above the floor. Do not let young children climb on the towel rail, supervision should be provided when nearby.
7. **DO NOT** immerse the towel rail in any liquid. It would be very dangerous to put the towels or anything else which has been in contact with hazardous liquids on this towel rail.
8. The power cord must be positioned so that it is not subject to splashing or ingress of moisture. The power cord should never touch heated surfaces. If the electrical cord or connection is damaged **DO NOT** attempt to repair, please contact the supplier.
9. To reduce the risk of injury, do not drape the power cord over the countertop or tabletop where it can be pulled down by children or tripped over.
10. A short power-supply cord (or detachable power-supply cord) has been provided to reduce the risk of being entangled or tripping over.
11. Please ensure this device is installed, connected, and working correctly.

Product Components

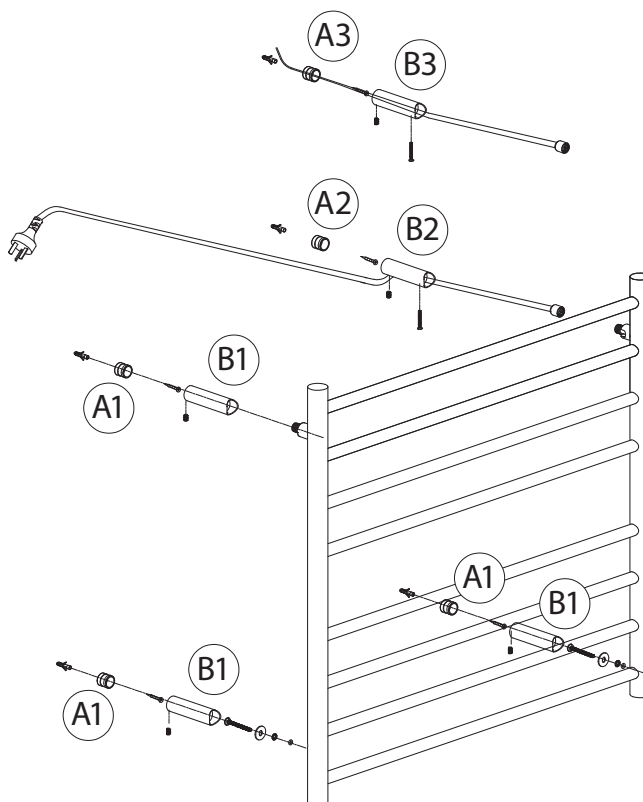
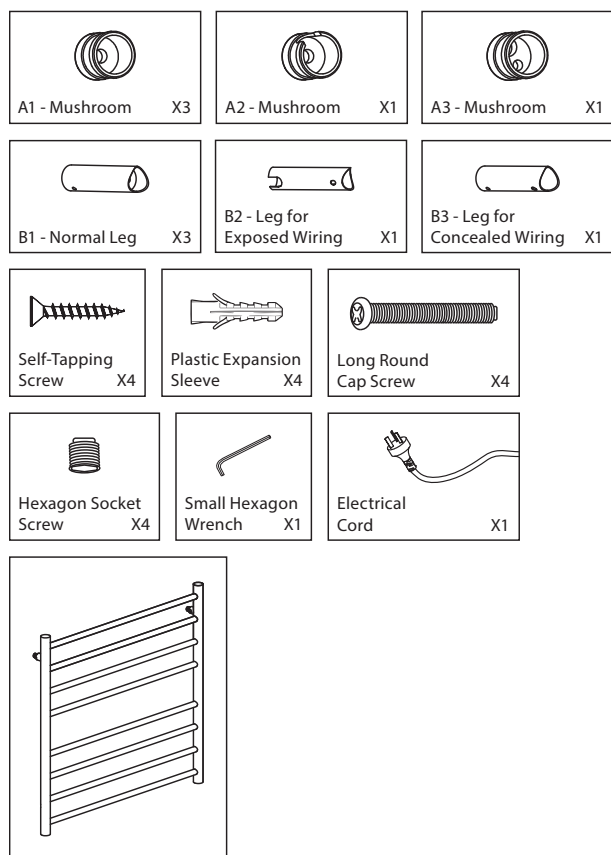

All installations must be carried out by a licensed tradesperson in accordance with all applicable Building, Plumbing and Electrical codes, and Federal, State, or Local Government Regulations in accordance with AS/NZS 3500 Plumbing & Drainage, AS/NZS 6400:2016 Water Efficient Products, and AS/NZS 3000:2007 Electrical standards for any installations to which these standards apply.

Installation Types

There are two options for installing this heated towel rail:

Concealed Wiring (Hard-Wired) - Provisions must be made for a switched supply wire to feed through the wall surface. The wire is located at the preferred mounting point for the towel rail. This type of installation **MUST** be performed by a licensed electrician.

Exposed Wiring (Plug-In) - A switched plug socket is required within 1 metre of the preferred mounting point for the towel rail.

Concealed Wiring Installation (Hard-Wired)

This appliance **MUST be installed by a licensed electrician.**

1. Remove the towel rail from the box. Check all parts are supplied against the Product Accessories List. For Concealed Wiring Installation you will not require A2 mushroom or B2 leg.
2. Unscrew the blue safety cap on the towel rail plug according to the position of the wiring outlet you require.
3. Take out the B3 Leg for concealed installation. Put the cord through B3 Leg and attach the B3 Leg onto the Rail with the Long Round Cap Screw provided. Install the 3 x B1 Normal Legs using the 3 other Long Round Cap Screws.
4. Put the towel rail against the wall in the desired position, and using a pencil draw around the end of each leg to mark the leg fixing positions on the wall. Remove the towel rail from the wall.
5. Using a suitable drill bit, drill the holes to the required screw depth into the centre of the drawn circles on the wall at each fixing point.
6. Place the 4 plastic expansion sleeves into the drilled holes.
7. Using a self-tapping screw, screw the A3 mushroom onto the wall at the wire connection point. Insert the electrical wire through the hole in the A3 mushroom for concealed hard wiring.
8. Fix the 3 other A1 mushrooms onto the 3 other fixing points on the wall using the 3 self-tapping screws.
9. Put the towel rail up on the wall, once the 4 legs are in place covering the 4 mushrooms, use the Allen Key provided to fasten the legs onto the wall by inserting the 4 Hexagon Socket screws into the hole in each leg, then tighten the Socket screws into the mushrooms.

Exposed Wiring Installation (Plug-In)

1. Remove the towel rail from the box. Check all parts are supplied against the Product Accessories List. For Exposed Wiring Installation you will not require A3 mushroom or B3 leg.
2. Unscrew the blue safety cap on the towel rail plug according to the position of the wiring outlet you require.
3. Take out the B2 Leg. Put the power cord through the B2 Leg and connect the cord into the plug in the required position.
4. Attach the B2 Leg onto the Rail with the Long Round Cap Screw provided. The power cord fits through the hole at the base of the leg so that the leg sits flush against the wall. Face the hole in the leg in the direction you require the cord to be exposed from. Then install the 3 x B1 Normal Legs using the 3 other Long Round Cap Screws.
5. Put the towel rail against the wall in the desired position, and using a pencil draw around the end of each leg to mark the leg fixing positions on the wall. Remove the towel rail from the wall.
6. Using a suitable drill bit, drill the holes to the required screw depth into the centre of the drawn circles on the wall at each fixing point.
7. Place the 4 plastic expansion sleeves into the drilled holes. Fix the 3 other A1 mushrooms onto the fixing point on the wall using the self-tapping screws.
8. Using the self-tapping screws, screw mushroom A2 onto the wall at the wire connection point.
9. Fix the 3 x A1 mushrooms onto the 3 other fixing points on the wall using the self-tapping screws.
10. Put the towel rail up on the wall, once the 4 legs are in place covering the 4 mushrooms, and the power cord is neatly sitting through the hole in the B2 leg, use the Allen Key provided to fasten the legs onto the wall by inserting the 4 Hexagon Socket screws into the hole in each leg, then tighten the Socket screws into the mushrooms.

Cleaning & Care

Fienza Heated Towel Rails are manufactured from stainless steel (SUS304). It is recommended that you clean the heated towel rail with a soft damp cloth. Only use cleaning products suitable for stainless steel surfaces.

All installations must be carried out by a licensed tradesperson in accordance with all applicable Building, Plumbing and Electrical codes, and Federal, State, or Local Government Regulations in accordance with AS/NZS 3500 Plumbing & Drainage, AS/NZS 6400:2016 Water Efficient Products, and AS/NZS 3000:2007 Electrical standards for any installations to which these standards apply.

Warranties

Residential Warranty Periods

Applies to domestic uses and applications of Fienza® products, such as private dwellings and retirement villages.

Commercial Warranty Periods

Applies to commercial uses and applications of Fienza® products, including, but not limited to: commercial food premises such as restaurants; commercial accommodation such as hotels; hospitals and healthcare facilities; public amenities; and industrial, laboratory and manufacturing facilities.

Product Component	Residential	Commercial
Structure Only	15 years replacement parts or product, 1 year labour	7 years replacement parts or product
Electrical	5 years replacement parts or product, 1 year labour	2 years replacement parts or product
Finishes - Chrome	15 years replacement parts or product, 1 year labour	7 years replacement parts or product
Finishes - PVD	10 years replacement parts or product, 1 year labour	5 years replacement parts or product, 1 year labour
Finishes - Powder Coated	2 years replacement parts or product, 1 year labour	1 year replacement parts or product

Warranty Conditions

- Installation has been carried out by a licensed tradesperson in accordance with all applicable Building, Plumbing and Electrical codes, and Federal, State, or Local Government Regulations in accordance with AS/NZS 3500 Plumbing & Drainage, AS/NZS 6400:2016 Water Efficient Products, and AS/NZS 3000:2007 Electrical standards for any installations to which these standards apply.
- All maintenance and adjustments to the product after the installation have been carried out by a licensed tradesperson.
- All care and cleaning instructions have been adhered to as prescribed.
- All goods of substandard quality manufacture (excluding imperfections permitted within AS1976 - Vitreous China used in Sanitary Applications) will be credited or replaced by Fienza when advised within the warranty period, subject to prior inspection and agreement.
- Proof of purchase is required for warranty claims.

Warranty Limitations

To the extent permitted under the Trade Practices Act and other relevant legislation, Fienza’s liability is limited to:

- The cost of replacing the goods, or
- The cost of obtaining equivalent goods, or
- The cost of having the goods repaired.
- Fienza is not responsible for any lack of operation or performance of goods (or any loss or damage) where goods are used or adapted for use with other goods not supplied by Fienza.
- It is the responsibility of the customer and installer before installation to ensure that all components are correct and free of obvious visible faults.
- Fienza is not responsible for the labour and rectification costs incurred in the above circumstance.

Conditions for On-Site Warranty Service Calls

Fienza will charge a service fee for each visit to an installation by its technician where it is determined that the fault is due to poorly executed or unlicensed installation work or where the product is not a genuine Fienza product or where the product is outside the warranty period. This may be paid in advance by credit card over the phone to a Fienza technician attending the site and will be refunded if the Fienza product is found to be at fault.

For warranty support, please contact Fienza

2 Bailey Court, Brendale QLD 4500 PO Box 5381, Brendale QLD 4500
P 07 3490 6700 **F** 07 3490 6719 **E** help@fienza.com.au ABN 76 136 411 311



All installations must be carried out by a licensed tradesperson in accordance with all applicable Building, Plumbing and Electrical codes, and Federal, State, or Local Government Regulations in accordance with AS/NZS 3500 Plumbing & Drainage, AS/NZS 6400:2016 Water Efficient Products, and AS/NZS 3000:2007 Electrical standards for any installations to which these standards apply.