

**1**

Cut a mounting hole 35mm in diameter. There must be a minimum 12mm width of flat around the hole.

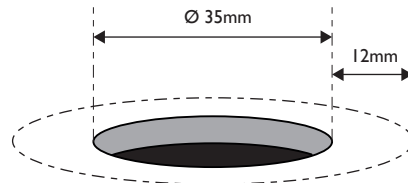

**2**

Screw the Threaded Rod into the Mixer Body.

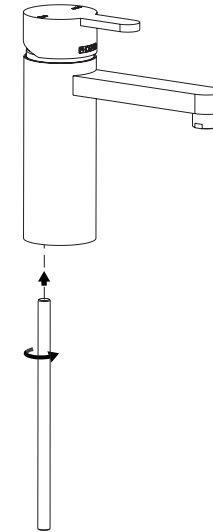

**3**

Screw the Red Marked Hose into the hole marked 'H' and the Blue Marked Hose into the hole marked 'C'.

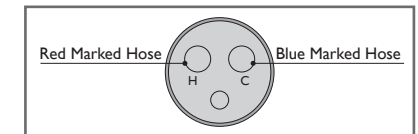
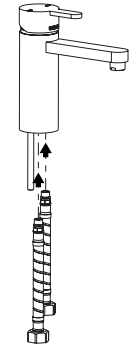

**4**

Fit the O-Ring into the groove under the Dress Ring.

Position the Dress Ring over the Mounting Hole.

Place the Mixer Body onto the Dress Ring.

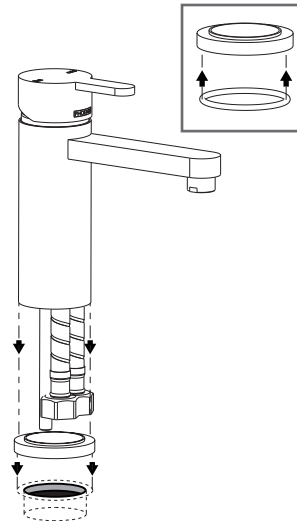

**5**

Underneath the Mounting Hole, feed the Rubber Mounting Gasket then the Mounting Plate onto the Threaded Rod.

Firmly fasten the Locknut using the provided Locknut Spanner.

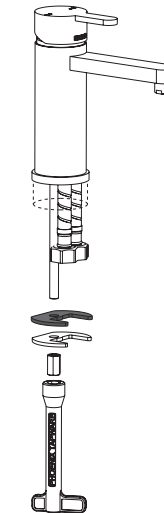

**6**

Connect hoses to the water supply.

Test and check for leaks.

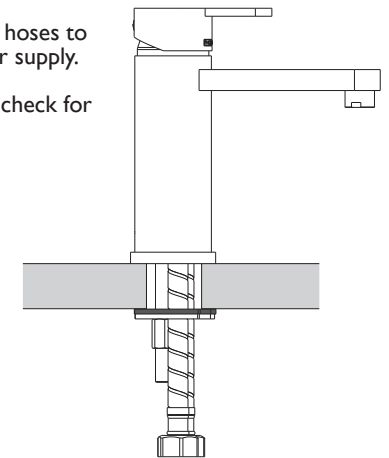

recommended working pressure  
**150-500 KPa**

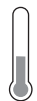

maximum hot water temperature  
**75 degrees**

**NOTE:**

- If the pressure exceeds or is likely to exceed 550kpa, an approved pressure limiting device must be installed.
- Flush out all pipe work prior to installation.
- If the water temperature exceeds 75°C, an approved tempering valve must be fitted.
- Installation should comply with Australian standard AS3500.1 or relevant local authority requirements. Showers may not be suitable for use within:
  - Gravity-fed water systems
  - Some instantaneous hot water systems; or

- Pressure supply less than 150kPa;

NOTE: The 500kPa maximum water supply pressure does not apply to fire service outlets.

Failure to comply with the above may void all warranties.

**WARRANTY:**

Please refer to the full warranty statement enclosed with the product before installing. Or visit [www.phoenixtapware.com.au](http://www.phoenixtapware.com.au) to download a copy.

**MAINTENANCE AND CARE:**

- Products should be cleaned with mild liquid detergent or soap and water.
- Do not use cream cleaners or citrus based cleaning products, as they are abrasive.
- Use of unsuitable cleaning agents may damage the surface. Any damage caused in this way will not be covered by warranty.

**DISCLAIMER:**

While we aim to ensure the specifications shown are correct at the time of printing, Phoenix Tapware reserves the right to make modifications without prior notice. Always use the physical product measurements for mark-ups and roughing-in as the line drawing shown may differ from the actual product over time.

\*All measurements are shown in millimeters.