

GLOBAL LEADER IN PORTABLE SAWMILL INNOVATION



BUILD YOUR  
DREAM.  
CREATE YOUR  
LEGACY.





**BUILD. CRAFT. GROW.**

**▶▶▶ MAKE YOUR MARK**





## START OF A REVOLUTION

### **Norwood Pioneered Personal Portable Sawmills**

1993 marked the start of the personal portable sawmill revolution. That's when Peter Dale introduced the world to the very first *affordable* portable sawmill—the original **LumberMate**. That was a turning point.



## A WORLD OF OPPORTUNITIES FOR EVERYONE.

Norwood opened a world of opportunities for everyone—for outdoorsmen, craftsmen, hard-working families, hobbyists and professional sawyers. But that was only the beginning.



## NORWOOD CONTINUES TO LEAD THE SAWMILL REVOLUTION.

Now, nearly 30 years later, Norwood continues to lead the sawmill revolution. Norwood mills are easier to use, have more patented innovations than all other mills combined, and offer you more customization options than ever before.



**A WORLD OF  
OPPORTUNITIES  
FOR EVERYONE** >>>



**WHILE NORWOOD MILLS HAVE EVOLVED,  
OUR MISSION REMAINS THE SAME:**

**TO EMPOWER PEOPLE  
EVERYWHERE TO BUILD  
THEIR BEST FUTURES  
THROUGH WOOD**

## NOTHING MATCHES A NORWOOD.

Norwoods are the most customizable mills available anywhere. Because your sawmill needs to be the perfect fit for the job now. And it has to keep up with you as your sawmilling operation grows in the future.

We're proud of the industry Norwood helped pioneer. After all, there are more portable mills than ever before. But, while there are many imitators, nothing matches a **genuine Norwood**.



## MAKE YOUR MARK.

Thousands of sawyers around the world put their trust in Norwood to unlock the value in their trees. Owning a Norwood puts you in control of your future.

To build. To craft. To grow. **To make your mark.**



# MORE SAWYERS CHOOSE A LEGENDARY NORWOOD

## 75+ patents

prove industry-leading  
innovation

## Quality-built

by master craftsmen  
right here at home

## Fun and easy-to-use

for new and experienced  
sawyers alike

## Most efficient

thanks to patented production-  
boosting **SAWYER-ASSIST**®  
technologies

## World's Only

infinitely-variable auto-  
locking sawhead for full  
dimensional control

## Rigid 4-post carriage

maximizes sawhead stability  
for even, accurate cuts

## Ultra-customizable

to meet **your unique** sawing needs—  
You can even transform your mill from  
manual to fully-hydraulic!

## In stock\*

so you're sawing in just days—  
not weeks or months

## Confidence

knowing you're supported  
by a team of sawyers!

\*While we typically have a large inventory and can ship your sawmill within just days, we cannot guarantee shipping times  
To confirm stock availability, ask your sawmilling specialist.





**QUALITY-BUILT BY  
MASTER  
CRAFTSMEN** >>>





## **PATENTS:** **PROOF-POSITIVE NORWOOD LEADS THE WAY IN SAWMILL INNOVATION.**

Norwood has earned the reputation as the global leader in portable sawmill innovation. Our 70+ patents are more than all the other sawmill companies around the world combined. That's why Norwood is known as the leader in the world of portable sawmills.

All so you can get more from your mill. Because your milling days should be your favorite days.

Norwood's 75+ patents represent thousands of hours of engineering, designing and testing. Here's what they mean to you—A mitt-full of intelligent designs and smart features only available on a Norwood.

**Which team do you want to be on?  
The one with a history of  
championships, or one of the others?**





## **QUALITY-MADE HERE AT HOME: FOR THE LONG HAUL & YOUR LEGACY.**

Professional tradesmen use cutting-edge fabrication technologies to build every Norwood sawmill. You'll be just as proud of your Norwood today as the day you pass the keys to your kids.

After all, Norwood mills are built to last generations. When you bring home a Norwood, you're investing in your future, your legacy and your country.



*BEWARE of sneaky language used by others: "BUILT in America".*

*That is code for "MADE" somewhere else and simply packaged or assembled here!*



## **FUN & EASY-TO-USE: WHETHER YOU'RE EXPERIENCED OR STARTING OUT.**

**Take control of your future with your own sawmill. Imagine the possibilities.**

- ▶ Build the house that will become your family's home.
- ▶ Craft the furniture that your family will cherish as heirlooms.
- ▶ Grow the business that will give your family a better life.
- ▶ Make the memories that will become your legacy.

Sawmilling is part of a lifestyle... a hands-on, outdoor, get-'er-done way of life... And it should be as fun as it is rewarding!

Norwood sawmills are engineered to crank out thousands of dollars-worth of valuable boards and beams. But, more importantly, they're designed to be easy to use. Because any equipment that works with you instead of against you is more productive... and a whole lot more fun!



## PATENTED SAWYER-ASSIST® TECHNOLOGY: GET MORE DONE FASTER.

Know you've got the right tool for the job with Sawyer-Assist technology—higher efficiency, better accuracy and unparalleled ease-of-use.

### Sawyer-Assist innovations are patented inventions no one else can offer:

- ▶ Infinitely-adjustable auto-locking sawhead (versus choice-choking, dimension-limiting pre-set cogged systems)
- ▶ Laminated sawhead and EZ-blade tension system for frustration-free blade changes
- ▶ Single-action multi-function operator's control
- ▶ Duradeck® laminated rail log deck

- ▶ Auto-locking adjustable blade guide
- ▶ Auto-lube system
- ▶ Quick-set log rests & quick-locking cam dogs
- ▶ Omega® deep-throat sawhead
- ▶ 4-axis fine-adjust blade guides
- ▶ Dura-Guide™ ceramic guides
- ▶ Log-dog assist
- ▶ Rapid-dogging & rolling system
- ▶ Log rest actuators

Saw your lumber with confidence knowing your mill is packed with intelligent Sawyer-Assist technology no one else can match.

U.S. Patent Nos. 6,932,555,  
9,102,074, 7,784,387,  
8,215,216, 8,261,645,  
8,261,647, 8,276,493, 8,820,727,  
9,676,116, 10,843,370, D816742,  
D818013, D834623, D831711,  
D639,319, D654,101, D638,040 &  
8,479,628

Canada Patent Nos. 2,432,863, 2,488,216,  
1,328,233, 2,541,734, 2,687,619, 2,687,622,  
2,687,623, 2,688,407, 2,696,974, 2,782,909,  
2,806,456, 2,800,791, 2,969,794, 3,037,006,  
3,097,733, 3,092,814, 3,101,140, 1,341,851, 1,330,499,  
1,697,851, 1,697,861, 1,697,871, 1,962,971 & 1,697,888

EU Patent Nos. EP 2,746,009 B1, EP 2,332,706 B1, EP  
2,332,683 B1, EP 2,684,631, EP 2,332,704, EP 2,759,384,  
1,117,196-0001; 0,012,123,933-0001; 0,012,172,777-0001,  
0,012,146,622-0001, 0,037,362,555-0001, 0,037,362,555-0002,  
0,037,362,555-0003, 0,037,362,555-0004, 0,084,650,666-0001

UK Patent Nos. 6124839, 6138704, 6151320

Brazil Patent Nos. BR30 2012 003601-1, BR10 2013 025882-2,  
BR10 2013 025883-0, PI 1004044-7, PI 1010352-0, DI 7001877-4,  
DI 7001876-6 & PI 1009180-7

Australia Patent Nos. 202111414, 201710613, 201710614, 201710616,  
201710615 & 202016960; China Patent No. 4192870, ZL202130153443.5  
— Other patents pending in multiple jurisdictions.

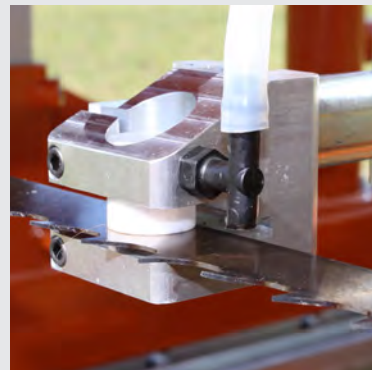



## INFINITELY-VARIABLE AUTO-LOCKING SAWHEAD: EXCEPTIONAL EFFICIENCY WITHOUT SACRIFICING CHOICE.

Meet Norwood's patented Infinitely-Variable Auto-Locking Sawhead. Designed to remove repetitive steps, so you can enjoy more time cutting.

Imagine eliminating two steps for every board you cut. This adds up to hundreds of operations each day. Wouldn't you rather spend more time doing the fun stuff?

Adjusting the sawhead is also as accurate as it is easy. Because it is infinitely-variable, you have absolute control to fine-tune the precise thickness of every board.



*BEWARE of frustrating choice-limiting cogged systems—Others claim to be “auto-locking” but take away your freedom to precisely choose your cut depth.*



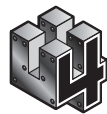

## **RIGID 4-POST CARRIAGE FRAME: SUPERIOR STABILITY MEANS EVEN CUTTING.**

Stop worrying about bounce, sag and sway. All Norwood bandmills use a 4-post carriage structure. This means better sawhead stability for even, accurate cutting.

**Norwood's mills don't stop there.**

2½" tubular steel rear vertical supports fortify the mill. And precision-extruded guides deliver smooth sawhead operation.

Run your Norwood confident the rigid carriage frame will give you accurate cuts.



*BEWARE of sag and sway seen on other mills where the sawhead is cantilevered on one side or perched on only two posts.*

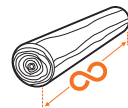

## **UNLIMITED LENGTH: KEEP YOUR OPTIONS OPEN TO SAW LONGER.**

Every Norwood bandmill has a standard 16-foot (4.8m) log deck so you can cut up to 13-feet (4m) long depending on the model.

But you don't need to stop there. Add one, or several, optional 4-foot (1.2m) extensions to saw longer.\*

Some Norwood owners are sawing logs over 40 feet (12.1 m)! ...  
Imagine the possibilities!

\* Limit of one permanent 4-foot (1.2m) log deck extension on trailer-equipped models.





## **EZ BLADE TENSION: FRUSTRATION-FREE BLADE CHANGES.**

It's time to say goodbye to frustrating blade changes and bandwheel adjustments!

Meet Norwood's patented laminated sawhead and EZ blade tension system.

Norwood's exclusive system preserves critical bandwheel alignment when you tension the blade. So your blade tensioning is easy and your blade changes fast. The result?... A whole lot more time milling with a smile on your face.

Just turn the "T" handle and have fun sawing!

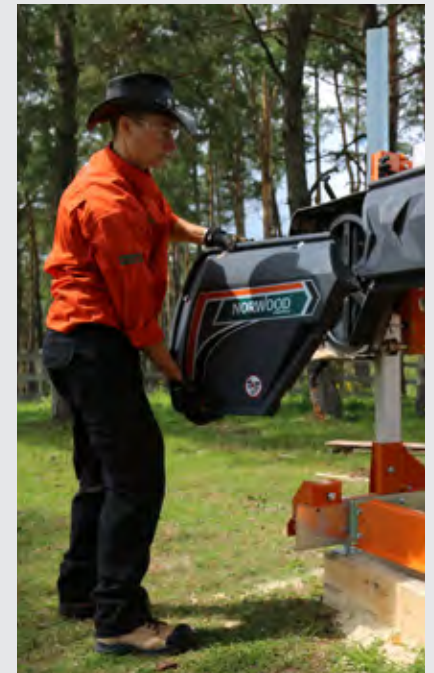



## **ULTRA-CUSTOMIZABLE: CONTROL YOUR SAWMILLING DESTINY.**

No two sawyers are the same. You need a sawmill **tailor-made just for you.**

Plus, your sawmilling needs will **grow** over time. When you tackle even bigger milling projects down the line, amp-up your Norwood with industry-leading 40+ production-boosting attachments.

**Don't get trapped with a mill that can't keep up.**

With a Norwood, you'll be just as proud of your mill 20 years from now as when you open up your first log.

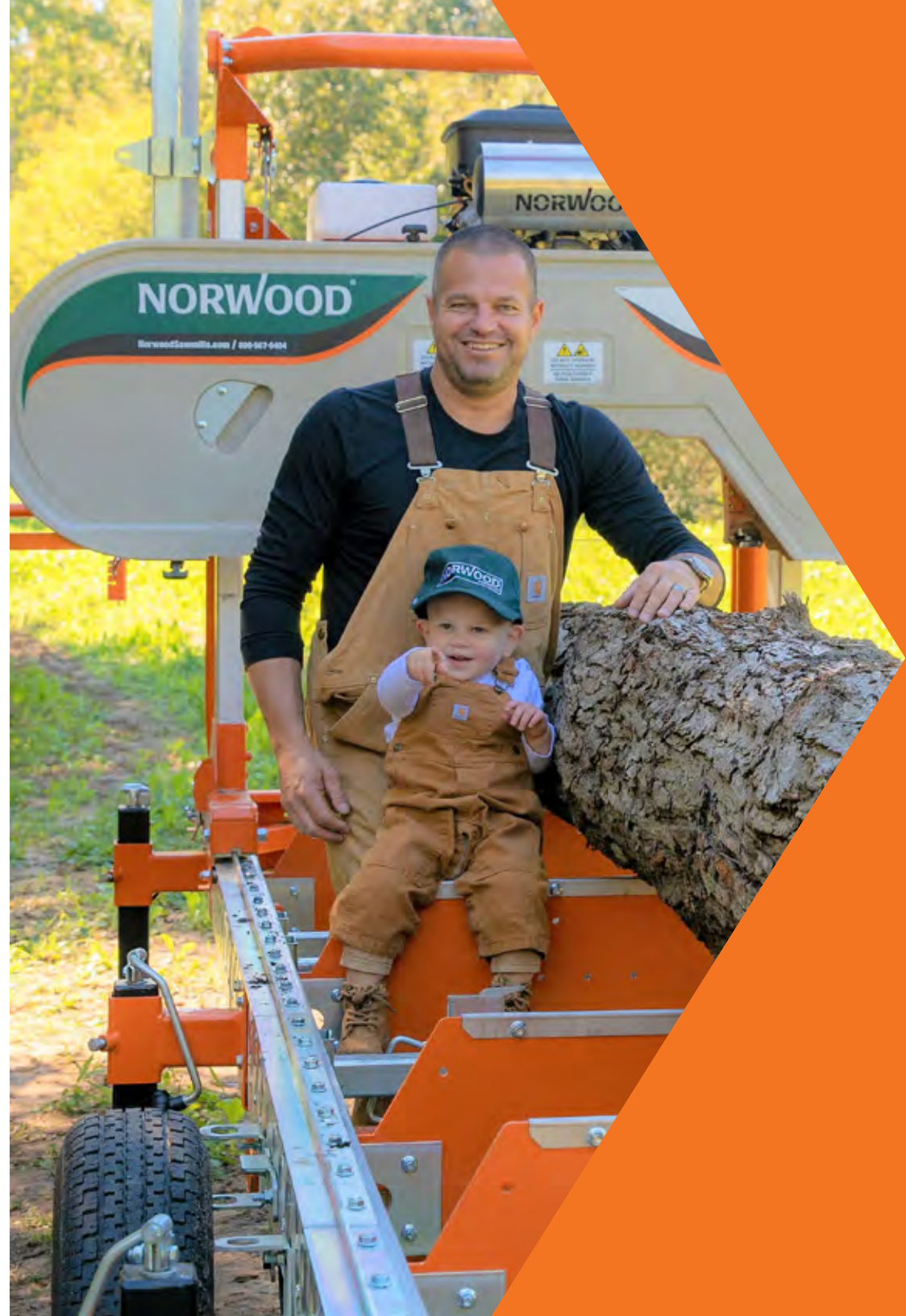



**LumberPro**

HD36

**TAILOR-MADE  
JUST FOR YOU** >>>

# UNDER THE HOOD OF YOUR NORWOOD

**NORWOOD SAWMILLS ARE LEGENDARY...  
BECAUSE WHAT COUNTS IS ON THE INSIDE.**

**Norwood packs more into our sawmills  
than any other company.**

From patented Sawyer-Assist® technology to intelligent production-boosting design, nothing matches a Norwood.

See for yourself! ▶

<p>1 Patented <i>infinitely-adjustable</i> auto-locking sawhead (versus choice-choking, dimension-limiting pre-set cogged systems)—Gives you full depth-of-cut control while sparing you 2 time-consuming operations per cut</p> <p><b>HD36V2 LM30 MN27</b></p>	<p>7 Patented Dura-Guide™ ceramic guides — Three-sided blade support without imposed deflection</p> <p><b>HD36V2 LM30 MN27</b></p>	<p>13 Quick-set log dog bar takes the guesswork out of clamping your cant low to make your last cut</p> <p><b>LM30 MN27</b></p>	<p>19 Omega® deep-throat sawhead delivers unparalleled capacity to mill oversized beams up to 14" (36 cm) deep</p> <p><b>HD38</b></p>
<p>2 Auto 1" indexing — Full revolution of sawhead winch automatically sets cutting head for one-inch (2.5 cm) boards</p> <p><b>HD36V2 LM30 MN27</b></p>	<p>8 4-Axis hybrid guides deliver optimal aligned support to the blade against deflection forces on longitudinal axis plus 3 linear axes</p> <p><b>HD38</b></p>	<p>14 Dual-profile log dog block with patented quick-disconnect function to reveal a third non-marring flat profile</p> <p><b>LM30 MN27</b></p>	<p>20 Patented auto-locking adjustable blade guide — Fast single-action system eliminates 2 time-wasting operations each cycle</p> <p><b>HD38 HD36V2 LM30 MN27</b></p>
<p>3 Blade-Lube System — Large custom-moulded water tank with wide-mouth port for easy refilling</p> <p><b>ALL</b></p>	<p>9 Sawdust exhausts on far side of mill away from you (not in your shoes)</p> <p><b>ALL</b></p>	<p>15 Commercial-grade powder-coating provides your investment with the ultimate protection</p> <p><b>ALL</b></p>	<p>21 Patented auto-ON/OFF blade lube system — Frees you from 2 time-wasting operations per cut.</p> <p><b>HD38 HD36V2 LM30 MN27</b></p>
<p>4 Rigid 4-post carriage frame for superior stability and performance</p> <p><b>ALL</b></p>	<p>10 Patented dual quick-set log rests &amp; quick-locking cam dogs — Rapid-action log clamping eliminates 2 operations per cycle with power to bite hard</p> <p><b>HD38 HD36V2</b></p>	<p>16 Mill logs of any length in stationary configuration. With two log deck extensions, you can cut up to 21 feet (6.4m). Add more to saw even longer!</p> <p><b>ALL</b></p>	<p>22 Time-saving single-action, multi-function operator's control boosts efficiency and your production — Simultaneously throttle up engine, engage blade and turn on blade lube (on auto-lube equipped model)</p> <p><b>ALL</b></p>
<p>5 Heavy-duty centrifugal clutch automatically engages the blade when you throttle up — simple, reliable, responsive</p> <p><b>ALL</b></p>	<p>11 Patented auto log-dogging assist — Holds log from roll-back during manual rotating operations</p> <p><b>HD38 HD36V2</b></p>	<p>17 Double-plated roll-formed galvanized steel log deck for ultimate strength under heavy loads</p> <p><b>HD38 HD36V2</b></p>	<p>23 Ergonomic tilt-height operator's station for all-day comfort</p> <p><b>ALL</b></p>
<p>6 International safety certified, Norwood sawmills meet stringent EU requirements</p> <p><b>ALL</b></p>	<p>12 Patented rapid-dogging &amp; rolling system — Easy rotating and one-handed single-action clamping of small sawlogs.</p> <p><b>ALL</b></p>	<p>18 Patented log rest actuators — Provides convenient control of log rests on operator's side</p> <p><b>HD38 HD36V2</b></p>	<p>24 Patented laminated sawhead with EZ blade-tension system for fast, frustration-free blade changes and maximum torsional sawhead strength</p> <p><b>ALL</b></p>

Features/technology are standard or optionally-available depending on model: **STANDARD** **OPTIONAL** To learn more, ask your sawmilling specialist.

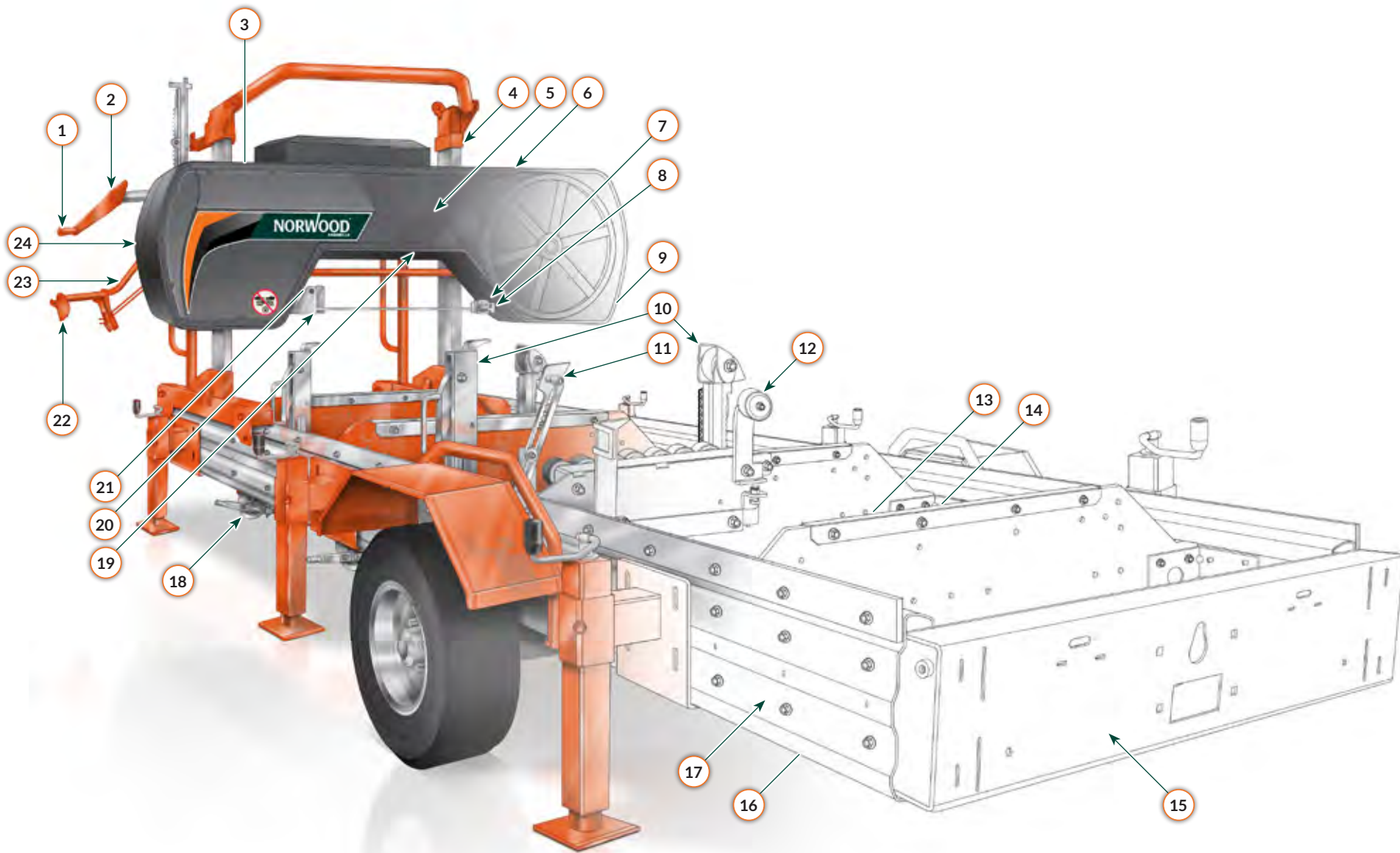

PROPRIETARY AND CONFIDENTIAL  
 THE INFORMATION CONTAINED IN THIS  
 DRAWING IS THE SOLE PROPERTY OF  
 NORWOOD SAWMILLS. ANY  
 REPRODUCTION IN PART OR AS A WHOLE  
 WITHOUT THE WRITTEN PERMISSION OF  
 NORWOOD SAWMILLS IS  
 PROHIBITED.

UNLESS OTHERWISE SPECIFIED:		NAME:	DATE:	ROW: Initial release
DIMENSIONS ARE IN INCHES		DRAWN:	C. Water	03/08/10
FRACTIONS (1/8)		CHECKED:	K. Worley	3/10/10
ANGULAR MATCHES BEND ± 5		ENG APPR:	P. Dale	3/17/10
TWO PLACE DECIMAL ± 0.01		MFG APPR:		
THREE PLACE DECIMAL ± 0.001		Q.A.	Pass	3/18/10
		COMMENTS:		
		MATERIAL:	See material list	
		FINISH:	None	
NEXT ASSY:	USED ON:	APPLICATION:		

**Norwood**  
**Sawmills**

SIZE DWG. NO. REV  
**C** LM08-00001

SCALE: 1:1 WEIGHT: SHEET 1 OF 1



# LUMBERMAN MN27

**SATISFACTION ISN'T IN  
COMPLETING THE JOB —  
IT'S IN STARTING A NEW ONE**

Take your projects to the next level with the LumberMan® MN27—Dependable, accurate and ready for your next legacy-building project.

Designed for hobbyists, the MN27 features industry-leading Sawyer-Assist technology to make milling lumber easy, enjoyable and precise.

What are you waiting for? Your legacy is waiting. Take the first step with your new Norwood MN27.

\*Shown with optional leveling legs

# LUMBERMAN MN27

SAWMILL TYPE: **BAND - MANUAL**



### LOG DIAMETER

- ▶ 27" (69 cm)



### POWER OPTIONS:

13½ hp (420 cc)	Briggs & Stratton recoil-start engine
7½ hp	Electric motor (5.5 kW, 400 V, 3 Ph, 50 Hz) (Europe)
5½ hp	Electric motor (4 kW, 400 V, 3 Ph, 50 Hz) (Europe)
5½ hp	Electric motor (4 kW, 230 V, 3 Ph, 50 Hz) (Europe)

*"I've got a MN26 and love it. I mill beams and slabs for customers and even trade some of the work on it for livestock to add to my ranch."*

Steven LeNoir ★★★★★

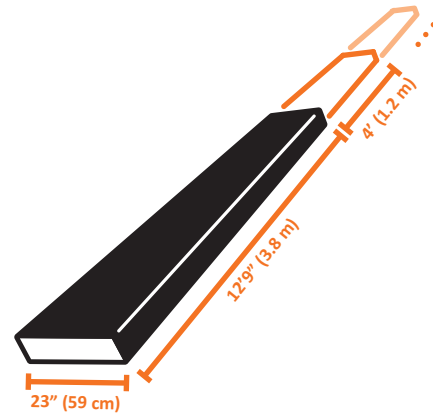

### CUT MEASUREMENTS:

- ▶ **Width of Cut:** 23" (59 cm)
- ▶ **Board Width:** 23" (59 cm)
- ▶ **Bed Length:** 16' (4.8 m)
- ▶ **Log Length:** 12'9" (3.8 m)

*Extend length with 4' (1.2 m) log deck extensions.*





## LUMBERMAN MN27

# THE SAWMILL THAT WORKS AS HARD AS YOU

It's not just any other tool in your shed. It will be the backbone of every project.

The MN27 takes everything you need from Norwood's collection of patented Sawyer-Assist technologies, and packs them into a capable, reliable, easy-to-use mill.

The LumberMan MN27 puts many of Norwood's patents in your hands.

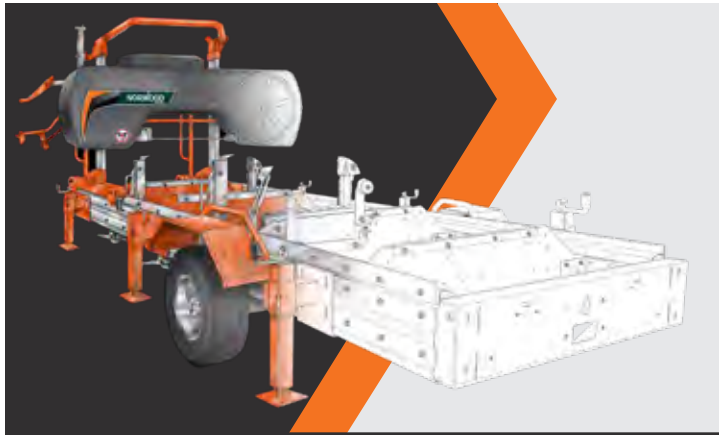

## SAWYER-ASSIST<sup>®</sup> INVENTIONS

See what's "Under the Hood of Your Norwood MN27."

▶ SEE PAGES 18-19

## PLUS THE LUMBERMAN MN27 FEATURES

### ▶ SAWDUST PORT

Rigid 4" tubular port directs sawdust down towards the ground. Or use it to connect a chip-extractor and exhaust the sawdust outside your sawing shed.

### ▶ BLADE GUIDES

The dual fixed 1¼" blade guides are precision-machined, hardened, zinc-dichromate plated, and include sealed double ball bearings.

### ▶ LEVELING FEET

Ten micro-adjust leveling feet for ground-level stationary sawing help ensure the mill stays stable for safe, accurate cuts.

### ▶ LOG DOG BLOCK

Dual-profile log-clamp block with patented quick-disconnect functionality to expose third profile—mar-reducing flat surface that helps protect your valuable sawn wood.

### ▶ LOG DOG SET BAR

Patented quick-set bar takes the guesswork out of clamping your cant low to make your last cut. In its engaged position, the set bar sets your log dog perfectly to firmly bite low and clear of the blade's path.



*Love the MN26. Best money I have ever spent. If you are looking for a sawmill, go with a Norwood.*

Rodney Slone, KY ★★★★★







## LUMBERMAN MN27 LIFETIME OWNER SUPPORT

Whether you're new to sawing or an experienced sawyer, everyone needs a hand from time to time. That's why every Norwood mill comes with lifetime toll-free support from our team of expert sawyers.

Build your confidence even before you get your sawmill. Learn sawing basics from set-up, to safety, to milling your first log in "Sawmill School", Sawmill TV®'s video series that covers the ABCs of milling.

When you invest in a Norwood, you join the Norwood family. We'll make sure you're supported from start to finish.

*I ordered the LumberMan MN26V2 a few days ago. I sold my Norwood LumberMate 2000 a few years ago but I missed it so much that I had to order another sawmill. Buy a Norwood mill and you're buying the best for a very affordable mill. I have 35 years in hobby milling and Norwood has excellent customer service and standards behind their products."*

Scott Martell ★★★★★





## LUMBERMAN MN27

# RAISE YOUR GAME WITH CUSTOM ATTACHMENTS

Ultra-versatile, the LumberMan MN27 is up to the challenge of meeting your unique sawing needs—as you get started, and when you take your sawmilling operation to the next level.

Choose from a wide range of attachments to custom-build your perfect MN27 mill now, confident you can upgrade it even more later.

Norwood sawmills give you maximum control over your sawmilling destiny. And, like every mill that carries the legendary Norwood name, the MN27 is built to grow together with you.



## CUSTOMIZATION ATTACHMENTS

See how you can customize your MN27.

▶ SEE PAGES 58–65



# LUMBERMATE LM30

## ADVENTURE READY.

It's not about just one project.  
Or fancy woodworking.  
Or beautiful live-edge slabs.

**It's also about hands-on, get-the-job-done, outdoor way-of-life.**

Sometimes it's fine furniture. Sometimes cabins. Sometimes a playhouse for your kids... And sometimes it's just about doing the job yourself—your way.

Whatever your reason, sawmilling is an adventure. It's your adventure. And the Norwood LumberMate® LM30 will be there for you every step of the way.

\*Shown with optional trailer and support jack system

# LUMBERMATE LM30

SAWMILL TYPE: **BAND— MANUAL**

Up to 3900 board-feet per day\*

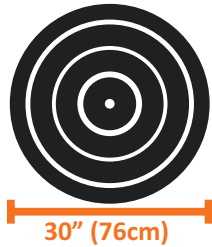

**LOG DIAMETER**

- ▶ 30" (76 cm)



**POWER OPTIONS:**

13½ hp (420 cc)	Briggs & Stratton electric-start engine
14 hp (429 cc)	Kohler OHV recoil-start engine
13 hp (390 cc)	Honda GX-Series OHV recoil-start engine
18 hp (570 cc)	Briggs V-Twin Vanguard OHV electric-start engine
10 hp	Electric motor (7½ kW, 400 V, 3 Ph, 50 Hz) (Europe)
10 hp	Electric motor (8 kW, 230/400 V, 3 Ph, 50 Hz) (Europe)
7½ hp	Electric motor (5½ kW, 400 V, 3 Ph, 50 Hz) (Europe)

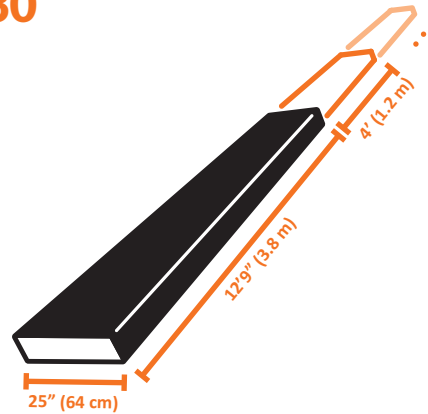

**CUT MEASUREMENTS:**

- ▶ **Width of Cut:** 25" (64 cm)
- ▶ **Board Width:** 24" (61 cm)
- ▶ **Bed Length:** 16' (4.8 m)
- ▶ **Log Length:** 12'9" (3.8 m)

*Extend length with 4' (1.2 m) log deck extensions.*



\* Under strict test conditions at the 2013 Shoot-Out, the 16 hp-equipped LumberMate LM29 milled 478 board-feet/hour of yellow poplar boards (equivalent to 3912 board-feet/day). Production figures vary depending on many variables.

Images show sawmill equipped with optional attachments



## LUMBERMATE LM30

# PATENTED SAWYER-ASSIST® TECHNOLOGIES

The LumberMate LM30 features industry-leading Sawyer-Assist technology, so you can process your timber with confidence.

Patented features include infinitely-variable auto-locking sawhead, EZ-blade tension for frustration-free blade changes, available auto-blade lube and rapid-dogging/rolling system.

With Sawyer-Assist, nothing can match a Norwood.

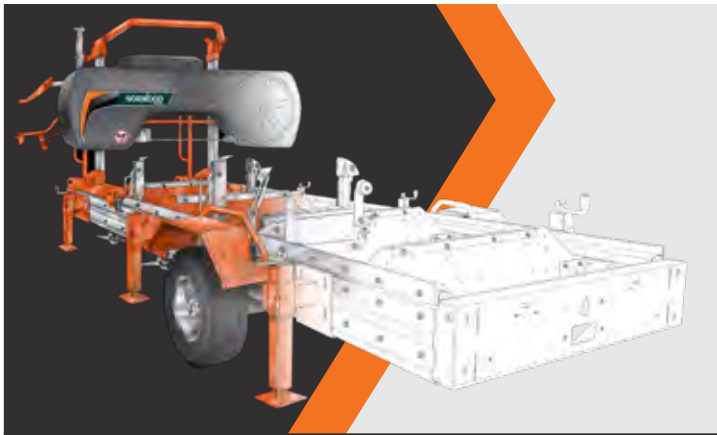

## SAWYER-ASSIST® INVENTIONS

See what's "Under the Hood of Your Norwood LM30."

▶ SEE PAGES 18-19

## PLUS

# THE LUMBERMATE LM30 FEATURES

### ▶ VERSATILE LOG CLAMPS

Twin vertical-adjust, 3-function log rests optimize clamping of your sawlogs, cants and boards, and solid-steel log dog.

### ▶ BLADE GUIDES

Two 1 ¼" precision-machined, hardened and zinc-dichromate plated blade-guide rollers are fitted with sealed double ball bearings: One fixed, and one patented easy-adjust with quick-locking.

### ▶ LEVELING FEET

Ten micro-adjust leveling feet for ground-level stationary sawing come standard.

### ▶ LOG DOG BLOCK

Dual-profile log-clamp block with patented quick-disconnect functionality to expose third profile—mar-reducing flat surface that helps protect your valuable sawn wood.

### ▶ LOG DOG SET BAR

Patented quick-set bar takes the guesswork out of clamping your cant low to make your last cut. In its engaged position, the set bar sets your log dog perfectly to firmly bite low and clear of the blade's path.

## BEST-IN-CLASS POWER

Raw power rules when you're muscling through oversize logs and tough hardwoods.

And the LumberMate LM30, with its available 18 hp V-twin engine, beats other sawmills in its class with a displacement volume of 570 cc.



*\*shown with optional trailer, support jacks and road packages*



**YOUR MILL  
YOUR WAY**





## LUMBERMATE LM30 CUSTOMIZE YOUR MILL, YOUR WAY

Your sawing needs are unique, and they'll grow over time as you take on bigger milling jobs. That's why you can tailor your LumberMate LM30, just for you.

With multiple customization options, build the perfect mill for your sawmilling adventure. Amp-up your LM30 anytime—now or down the road.

One thing's for sure... you'll be just as proud to show off your Norwood today as you will be a decade from now.



## CUSTOMIZATION ATTACHMENTS

See how you can customize your LM30.

▶ SEE PAGES 58-65

*\*shown with optional trailer system modules*

LUMBERMATE LM30

# LUMBERPRO HD36V2

## LEGENDARY DEPENDABILITY—FOR TODAY AND OVER THE LONG HAUL

Looking for legendary? You've found it. Meet the LumberPro<sup>®</sup> HD36V2.

With impressive log capacity, Sawyer-Assist<sup>®</sup> technologies, and more custom options than any portable mill on the market, the HD36V2 is made to handle your toughest jobs.

The LumberPro HD36V2 is built to Norwood's toughest standards of strength and durability—to get the job done reliably—today and over the long haul. Because Working As Hard As You™ isn't just a slogan... it's a way of life.

And it's an attitude that has produced the world's premier line of rugged and dependable portable sawmills for over a quarter century.

Whether you're building your bottom line, your family's future, or your legacy, the HD36V2 has your back.

So, what are you waiting for? Build something incredible with the LumberPro HD36V2.

\*Shown with optional trailer, support jack system, log loader, toe boards and log dog assist

# LUMBERPRO HD36V2

SAWMILL TYPES: **BAND – MANUAL**

**BAND – FULLY HYDRAULIC**

(convertible to hydraulic anytime with optional attachments)



## LOG DIAMETER

- ▶ 36" (92 cm)



## POWER OPTIONS:

18 hp (570 cc)	Briggs V-Twin Vanguard OHV electric-start engine
23 hp (627 cc)	Briggs V-Twin Vanguard OHV electric-start engine
15 hp	Electric motor (11 kW, 230/460 V, 3 Ph, 60 Hz)
15 hp	Electric motor (11 kW, 230/400 V, 3 Ph, 50 Hz) (Europe)
10 hp	Electric motor (7½ kW, 230 V, 1 Ph, 60 Hz)
10 hp	Electric motor (7½ kW, 400 V, 3 Ph, 50 Hz) (Europe)
10 hp	Electric motor (8 kW, 230/400 V, 3 Ph, 50 Hz) (Europe)

\* Under strict test conditions at the 2015 Shoot-Out, the manually-configured LumberPro HD36 milled 700+ board-feet/hour of yellow poplar boards (equivalent to 5600 board-feet/day). Production figures vary depending on many variables.

Images show sawmill equipped with optional attachments.

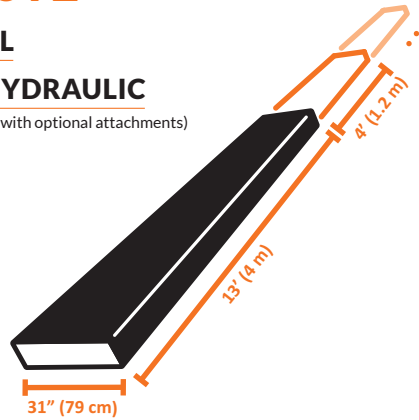

## CUT MEASUREMENTS:

- ▶ **Width of Cut:** 31" (79 cm)
- ▶ **Board Width:** 30" (76 cm)  
(28" (71 cm) in hydraulic configuration)
- ▶ **Bed Length:** 16' (4.8 m)
- ▶ **Log Length:** 13' (4 m)

*Extend length with 4' (1.2 m) and 2' (0.6 m) log deck extensions.*





## LUMBERPRO HD36V2

# PATENTED SAWYER-ASSIST® TECHNOLOGIES

The LumberPro HD36V2, packed with loads of industry-leading Sawyer-Assist technologies, is ready to take your milling operation to the next level—and beyond.

Loaded bumper to bumper with Sawyer-Assist innovations, **nothing matches the Norwood HD36V2.**

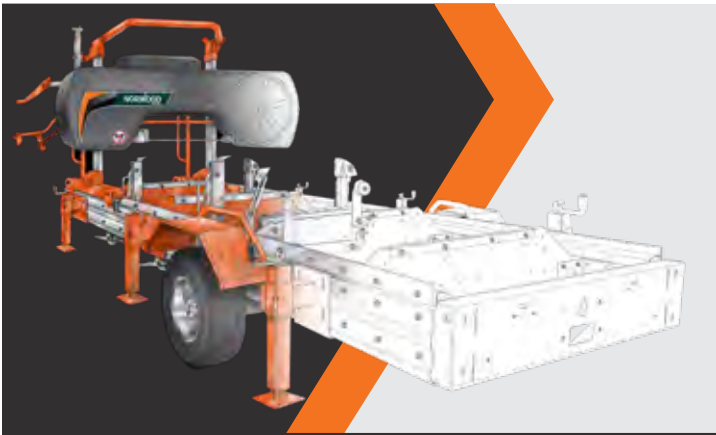

## SAWYER-ASSIST® INVENTIONS

See what's "Under the Hood of Your Norwood HD36V2."

▶ SEE PAGES 18-19

## PLUS

# THE LUMBERPRO HD36V2 FEATURES

### ▶ ULTIMATE FLEXIBILITY TO GO FULLY HYDRAULIC

Harness the muscle of hydraulics: Build up your HD36V2 with hydraulic log loading, rolling, clamping and toe boards. Power it up: Add remote-control power-feed, power sawhead or intelligent networks.

### ▶ QUICK-SET, AUTO-LOCKING LOG RESTS

Fast, one-handed vertical adjustment, auto-locking and single-action retraction of log rests saves you time and aggravation.

### ▶ MOVABLE LOG CLAMPING STATIONS

Quickly change log clamping positions along your log deck to mill ultra-short or ultra-long logs. Designed for rapid-repositioning, log clamping stations can be moved to available extra receivers installed along the bed.

### ▶ LATERALLY-ADJUSTABLE LOG RESTS

Safely and quickly mill irregular or knotty logs using the laterally-adjustable log rests that you can move towards, or away, from the fixed blade guide.

### ▶ RUGGED OVER-CENTRE CAM DOGS

Powerful cam dogs bite hard and lock fast in both logs and cants.

### ▶ OVERSIZED BANDWHEELS

Measuring 20¼" x 7/8" (50 cm x 2.2 cm), the ultra-wide surface area of the HD36V2's commercial-size cast-iron, precision-machined and balanced bandwheels minimizes blade cupping and delivers maximum blade support for truer cuts and extended blade life.

### ▶ DEBRIS-SHEDDING CROSS-BUNKS

Avoid uneven cuts from debris-build-up under your cant thanks to the sawdust-shedding narrow-profile plate-steel cross-bunks. Equipped standard with stainless-steel caps to prevent staining of your valuable hardwoods.





## LUMBERPRO HD36V2 YOUR POWER OF CHOICE

Whether you're looking to mill specialty cuts, slice off high-value slabs, or output some serious board footage,

LumberPro HD36V2 offers three different powerplants—including the powerful 23 hp V-Twin Vanguard packing 627 cc of displacement.

Whatever your operation, the LumberPro HD36V2 has the right power for you.



## LUMBERPRO HD36V2 HIGHEST-STRENGTH ULTRA-FUNCTIONAL LOG DECK

We took the hardest-working part of the LumberPro HD36V2 and made it stronger and more rigid than ever.

Engineered for maximum strength and torsional stability, Norwood's HD36V2 Duradeck® is built to get the job done. Its twin-laminated roll-formed high-strength steel rails with solid steel plate cross members handle even extreme loads.

Extremely functional, the Duradeck also accommodates all Sawyer-Assist® hydraulic and manual attachments for unparalleled modular versatility. The HD36V2's super-strong log-deck not only delivers accurate straight lumber. **It gives you ultimate control of your sawmilling destiny.**



## LUMBERPRO HD36V2

# ULTIMATE VERSATILITY – YOUR FREEDOM TO MAKE IT FULLY-HYDRAULIC

Norwood HD36V2 is built for extreme adventure starting with its big capacity and heavy-duty construction. Give it even more muscle and make it a fully-hydraulic powerhouse. Add manual or hydraulic log handling, power sawhead or power feed and unleash its full potential.

Super-productive in its manual configuration, step it up even more by adding yield-boosting attachments. In fact, LumberPro HD36V2 offers more customization options than any other sawmill on the planet.

You're free to choose when and how you upgrade your mill. Build your dream mill from day-one. Or, start affordably with the HD36V2's stationary manual configuration, and then build it up as your milling operation grows. The choice is yours.

From added features for enhanced production capabilities to powerful accessories, the Norwood HD36V2 lets you make an individual statement. Ultimately, your friends will be in awe of your fully-hydraulic commercial-grade Norwood HD36V2 in your milling shed... right next to your stacks of valuable lumber.

The LumberPro HD36V2 is built for people who demand results. It's for people who work hard and deliver the best. The HD36V2 is for people who want to make a statement.







NORWOOD

NorwoodSawmills.com / 800-987-0454

NORWOOD

LumberPro

# LUMBERMAX<sup>®</sup>

## HD38

### TAKE COMMAND

When the biggest jobs call, Norwood's LumberMax<sup>®</sup> HD38 steps up.

The HD38 is a sawmill engineered and built to go where other sawmills can't. Take it to the max with colossal capacity, next-generation patented technologies and exceptional versatility.

In manual or hydraulic configuration, the LumberMax is everything you've fantasized a sawmill should be—and you'll know it the moment you plunge the blade into the first cut.

Impressive oversized cutting capacity combine with rugged carriage and log deck engineering to deliver unmatched output capabilities: Tackle massive logs up to 38 inches in diameter. Saw deeper. Cut wider. **Make a bold statement.**

Norwood's HD38 takes the gloves off.  
**Now take command.**

\*Shown with optional trailer/support jack system and optional hydraulic attachments

# LUMBERMAX HD38

SAWMILL TYPES: **BAND – MANUAL WITH POWER SAWHEAD**

## **BAND – FULLY HYDRAULIC**

(convertible to hydraulic anytime with optional attachments)

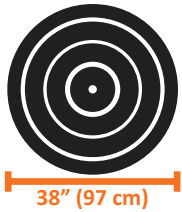

### LOG DIAMETER

- ▶ 38" (97 cm)



### POWER OPTIONS:

23 hp (627 cc) Briggs V-Twin Vanguard OHV electric-start engine

15 hp Electric motor (11 kW, 230/460 V, 3 Ph, 60 Hz)

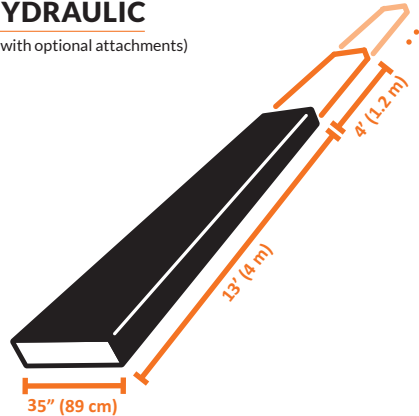

### CUT MEASUREMENTS:

- ▶ **Width of Cut:** 35" (89 cm)
- ▶ **Board Width:** 32" (81 cm)
- ▶ **Depth of Cut:** 14" (36 cm)
- ▶ **Bed Length:** 16' (4.8 m)
- ▶ **Log Length:** 13' (4 m)

*Extend length with 4' (1.2 m) and 2' (0.6 m) log deck extensions.*

Images show sawmill equipped with optional attachments.





## LUMBERMAX HD38

# MORE CAPACITY. GREATER CAPABILITY. ULTIMATE LEGENDARY.

Norwood's LumberMax HD38 credentials start with what counts: the most industry-leading Sawyer-Assist® technologies. They're teamed up with outstanding limitation-busting innovations to take your milling operation to the next level—and beyond.

Despite its jaw-dropping capabilities, the HD38 will have you confidently milling with a kid-in-a-candy-store grin on your face thanks to Norwood's practical innovations that make sawing as much fun as it is productive.

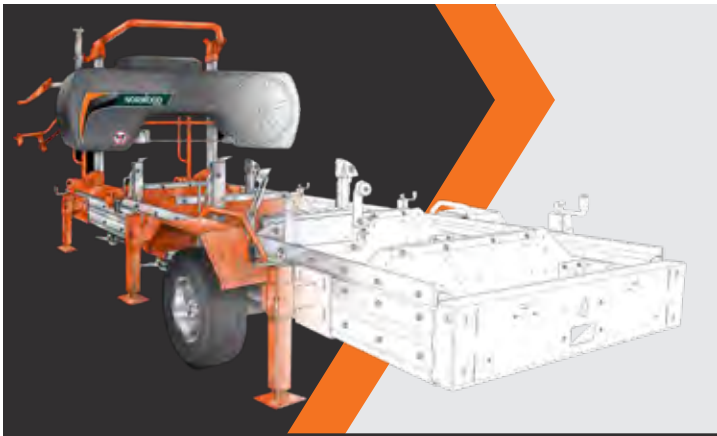

## SAWYER-ASSIST® INVENTIONS

See what's "Under the Hood of  
Your Norwood HD38."

▶ SEE PAGES 18-19

## PLUS THE LUMBERMAX HD38 FEATURES

### ▶ WIDE-SLAB CAPABILITY

The HD38's huge throat with integrated patented auto-locking adjustable guide system turns out prized slabs up to 35" (89 cm) wide.

### ▶ EXTREME DIMENSIONS

14" (36 cm) clearance over the blade produces impressive deep cuts, oversized beams and unparalleled output.

### ▶ DURADECK® LOG DECK

Engineered from the ground up for heavy-duty assignments, Norwood's patented Duradeck's twin-laminated roll-formed high-strength galvanized steel rails with solid steel plate cross members are designed and built to handle extreme loads.

### ▶ 4-AXIS MICRO-ADJUST GUIDES

Fine-tune the guides for optimally-aligned blade support on the longitudinal axis as well as all 3 linear axes.

### ▶ POWER SAWHEAD

Equipped standard with power sawhead up-down functionality. Activated by a 2-way toggle switch, you control the vertical speed by means of a potentiometer dial integrated into the operator-station-mounted control panel.

### ▶ TAKE IT TO THE MAX

Harness the muscle of hydraulics: Build up your HD38 with hydraulic log loading, rolling, clamping and toe boards. Power it up: Add wireless remote-control power-feed and IntelliSet™ computer networks.





## LUMBERMAX HD38

# WORLD'S ONLY OMEGA® DEEP-THROAT SAWHEAD

Produce oversized beams up to 14" (36 cm) in depth thanks to Norwood's patented Omega Sawhead engineered to deliver industry-leading deep-throat capacity.

The Omega pairs state-of-the-art "omega"-shape with Norwood's iconic patented laminated sawhead technology known for delivering superior rigidity and EZ blade tension functionality. Lowering the bandwheels relative to the drive train gives you the power to handle jaw-dropping dimensions.

Dual cast-aluminum rigid core frames, engineered to handle extreme load levels, tackle the biggest logs and open your wood to a world of massive opportunities.

Norwood's patented Omega is the ultimate in sawhead engineering that delivers it all: outstanding performance, ultra-confident capability and effortless sawing.

## LUMBERMAX HD38

# 4-AXIS ADJUSTABLE BLADE GUIDE TECHNOLOGY—CONTROL WITHOUT COMPROMISE

Norwood's advanced machined blade guide assembly delivers positive alignment of the blade through angular and lateral adjustment on all 3 axes. It also gives you control over the 4th axis—along the pitch plane about the blade's longitudinal axis.

Its patented pivoting shaft block to trunnion block geometry featuring a nominal fulcrum delivers precise fine-adjust control over both blade guides on the for-aft plane.

The state-of-the-art dual-technology guides pair ceramic blocks with bearing-equipped heat-treated steel rollers to protect against deflection forces exerted on the blade and deliver precise cuts.





NORWOOD

LumberMAX HD38



## LUMBERMAX HD38

# HYDRAULICS: READY, WILLING AND CAPABLE— CONQUER YOUR SAWMILLING DESTINY

Norwood HD38 was built big—so you can saw big. The ability to take on the biggest logs, make the deepest cut and mill ultra-wide slabs: That's the ultimate sawmill dream and the LumberMax HD38 is all that and more.

Crank up the volume even higher with available hydraulic and power attachments. Norwood's HD38 empowers you with outstanding choices—including high-power hydraulics and leading-edge computer networks. And you choose when and how you add them.

Add the muscle of hydraulics: the HD38 is willing and waiting—whenever you're ready. Available comprehensive hydraulic attachments include log loader, chain-drive log turner, log clamping and roller toe boards.

Take control. Make your mark.



### CUSTOMIZATION ATTACHMENTS

See how you can customize your  
HD38.

▶ SEE PAGES 66-82



▶▶▶ TAKE COMMAND.



# PORTAMILL PM14

**TRULY “PORTABLE” – EASY TO CARRY,  
EASY TO TRANSPORT, EASY TO STORE**

The PortaMill® PM14 is your ideal milling solution if...

- ▶ **Your sawmilling needs are occasional**
- ▶ **You need to mill lumber and beams in very remote locations**
- ▶ **You need to move your mill from site to site by small car, ATV, boat or airplane**
- ▶ **You need to tuck your mill away for storage**

With the Norwood PortaMill, you use your chainsaw as the sawhead and your household extension ladder as the track.

Mill hardwood and softwood logs up to 14" (36 cm) in diameter.

Cut accurate square beams and dimensional lumber up to 8" (20 cm) wide... 2×4's, 4×4's, 2×6's, 6×6's...



\*Shown with optional auxiliary chain & bar oiler kit

# PORTAMILL PM14

SAWMILL TYPE: **CHAINSAW**



14" (36 cm)

## LOG DIAMETER

- ▶ 14" (36 cm)

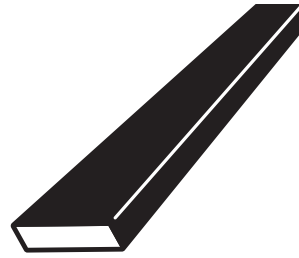

## CUT MEASUREMENTS:

- ▶ **Board Width:** 8" (20 cm)
- ▶ **Log Length:** Dependent on ladder

## CONVERT YOUR LOGS TO VALUABLE LUMBER WITH THE POWER OF YOUR CHAINSAW

### HERE'S HOW:

- ▶ **CLAMP YOUR LOG INTO PLACE**  
Use the log rests and adjustable log dogs.
- ▶ **CHOOSE YOUR CUTTING DEPTH**  
Turn the crank handle to smoothly raise and lower the chainsaw.
- ▶ **MAKE YOUR CUT**  
Engage the handle-mounted throttle and advance the saw along the track.

Chainsaw and ladder not included. The chainsaw must be equipped with two bar studs and with removable bar nuts.

Chainsaws of 50 cc or greater equipped with ripping chain recommended for small to mid-sized logs. Chainsaws of 65 cc or greater equipped with ripping chain recommended for mid-sized to larger logs and faster cutting speed. Maximum bar length: 24" (61 cm)



## PLUS THE PORTAMILL PM14 FEATURES

### ▶ LADDER ANCHORS

For solid track set-up. Quick connect /quick-disconnect knobs for easy, no tools set-up.

### ▶ TRACK SWEEPERS

Remove sawdust and debris from the track for smooth rolling action.

### ▶ ADJUSTABLE OUTRIGGER ARM

Adjusts to fit any extension ladder width. Equipped with two track sweepers and quick connect/quick-disconnect wheel keeper.

### ▶ LOG CLAMPING

Equipped standard with two log rest/log dog assemblies for fast dogging, positive locking. Also feature back dogs for easy clamping of beams, cants and boards.



### ▶ SAWBAR AND CHAIN GUARD

Helps guard sawbars up to 20" (51 cm) long.

### ▶ ACCURATE DEPTH-OF-CUT

Scale indicator to precisely set the depth-of-cut. Engage the sawhead locking handle to accurately lock the sawhead height.

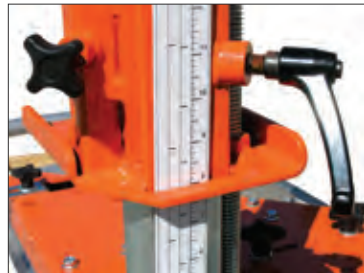

### ▶ AUXILIARY CHAIN & BAR OILER

(Optional) Chainsaw only delivers oil to the top of the bar where it is easily thrown off at the nose, especially when mounted sideways for milling. Oiler kit delivers oil to the sprocket of the chainsaw sawbar to reduce friction and chain heat. Includes bottle, bottle basket, oil line with valve and copper nozzle. (Item No. PM02)

### ▶ PROFESSIONAL "QUARTER SCALE"

Precisely mill 2" (5 cm) or 1" (2.5 cm) lumber with the 5/16<sup>th</sup> kerf already calculated in.

### ▶ SMOOTH SAWHEAD ACTION

Smooth operation of the crank handle to adjust sawhead height—Clockwise to raise the sawhead, counter-clockwise to lower the sawhead.

### ▶ OPERATOR COMFORT

Adjust the height of the push handle for operator comfort. Handle-mounted throttle control—squeeze to saw, release for idle.

### ▶ UNIQUE THROTTLE ACTUATOR

Patented mechanism fits all chainsaws. Permits easy activation of chainsaw throttle at the push handle.

The PortaMill is entirely quick-connect/quick-disconnect and takes just minutes to set up. Components are easy to carry, easy to transport and easy to store.

You probably already have a chainsaw and ladder in your garage right now... What projects could you do if you had your own sawmill?



## PORTAMILL TRACK SYSTEM

### ITEM NO. PM03

10' (305 cm) track custom-designed specifically for the PortaMill PM14. Engineered to maximize stability during cutting, the track system is built of precision-extruded aluminum rails coupled with powder-coated steel crossers. Mill as long as you want simply by adding optional track extensions.

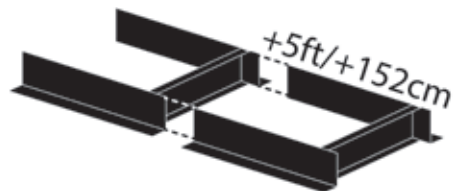

## TRACK SYSTEM EXTENSION

### ITEM NO. PM04

Easily extend your custom designed PortaMill track to mill logs and boards as long as you need. Each 5' (152 cm) extension bolts onto the end of your track.

Additional log clamping/cross bunk kits sold separately. (Item No. PM14-BUNKKIT)



## LOG-DOG/LOG-REST/ CROSS-BUNK KIT

### ITEM NO. PM14-BUNKKIT

Your PortaMill is equipped with two complete log clamping / bunk assemblies. To secure longer logs, add one or more extra sets.

Package includes one log dog, one log rest and one cross bunk body.

**SABREBAR® &  
SABERCHAIN®**



**Improve the performance  
and yield of your PortaMill.**

▶ SEE PAGE 96

# LOG MOULDER LX26

## TAKE YOUR SAWING TO THE NEXT LEVEL

Precisely shape and plane beams & oversized boards with maximum efficiency, right on your sawmill, with a Norwood Log Moulder LX26.

The Log Moulder LX26 is an incredibly powerful addition to your milling operation.

**The Log Moulder LX26 works right on your sawmill,** mounting on the rails of your mill. This means you can finish your beams immediately after squaring your log, all in one smooth step, without moving your log to another machine.

Equipped with a vertically-adjustable, horizontally-configured cutter-head, the LX26 easily connects to the log deck of your sawmill, rolling smoothly along the length of the bed, exactly like the sawmill carriage.

# LOG MOULDER LX26

## LOG PLANER & MOULDER

### MAXIMUM PLANING WIDTH

- ▶ 19" (48 cm) (single drum)
- ▶ 27" (69 cm) (with second optional drum)

### MAXIMUM CANT HEIGHT

- ▶ 23 ¾" (60 cm) (LM30, MN27)
- ▶ 21" (53 cm) (HD38, HD36V2)

### CANT HEIGHT (LAST BOARD MINIMUM)\*

- ▶ 4 ¾" (12 cm) (LM30 & MN27)
- ▶ 2" (5 cm) (HD38, HD36V2)



### POWER OPTIONS:

13 ½ hp (420 cc) Briggs & Stratton recoil-start engine

## AN INCREDIBLY POWERFUL ADDITION TO YOUR MILLING

### HERE'S WHY:

- ▶ Plane, finish, and shape cants and oversized boards right on your mill
- ▶ Precision-mould and joint for log-home construction
- ▶ Plane over-length lumber and full-size beams
- ▶ Customize porch columns, balcony & staircase posts, and more
- ▶ Craft unique furniture out of heavy, large dimension lumber woods

\* Defined by the minimum distance from the cutter to the top of the log deck cross-bunks. If your sawmill does not have raised cross bunks, or if you wish to finish last boards smaller than the minimums shown, you may need to build up your cross bunks to reduce the distance between the top of the log deck and the cutter head.

The LX26 must be removed from the sawmill before trailering or transporting the sawmill.





## PLUS THE LOG MOULDER LX26 FEATURES

### ▶ **MAXIMUM EFFICIENCY**

Your saw carriage and the Log Moulder LX26 work cooperatively on the log deck. It's convenient and as simple as this: First, square your log. Second, simply guide your Log Moulder along the same track over the beam to finish to your exact specifications. Simple. Seamless. Smart.

### ▶ **RELIABLE POWER PLANT**

When you unleash the ample capacity of the tried and true 13½ hp Briggs engine, you'll always have more than enough power to the cutter head via a centrifugal clutch.

### ▶ **FINISH PLANKS & BEAMS UP TO 27" (69 CM) WIDE**

Reliably finish beams up to 27" W\* x 21" H\*\* (69 cm x 53 cm).

The laterally-adjusting cutterhead housing slides up to 11" (28 cm) sideways, making it possible to plane surfaces up to 19" (48 cm) wide with one drum, or up to 27" (69 cm) when equipped with a second optional drum.

### ▶ **EXTREME LOG LENGTH**

Need to finish over-length timber? The LX26 won't miss a beat. Simply add log deck extensions to lengthen your sawmill track and you're in business.

### ▶ **LARGE-DIAMETER CUTTERHEAD DRUMS**

A beefy 8" x 4 13/16" (20 cm x 12 cm) cutterhead outfitted with a pair of 8" (20 cm) corrugated HSS planing knives are standard equipment on the versatile LX26. Add a second optional 8" (20 cm) cutterhead to plane beams and planks up to 16" (41 cm) in a single pass (Item No. LX26-CH8).

### ▶ **EASY CHIP EXTRACTION**

The Log Moulder LX26 doesn't need additional chip extraction equipment. You'll appreciate this simple but smart design element, as it makes things even easier for you.

### ▶ **QUICK KNIFE CHANGE-OVER & ADJUSTMENT**

Change knives quickly and easily through the easy-access hatch. All you need are a 6 mm Allen key and a set of locking & adjusting screws. A simple block ensures the knife edge is precisely where it needs to be.





▶ **EASILY ADAPTABLE TO MULTIPLE SAWMILLS**

The Log Moulder LX26 is designed to adapt to a variety of sawmill models including Norwood's HD38, HD36V2, HD36, LM30, LM29, MX34, & ML26. PLUS, it fits Norwood's 2000, MK3 & MK4 series sawmills. The adjustable carriage wheels accommodate rails 31"–33½" apart, and 40½–43" apart (79 cm–85 cm & 103 cm–110 cm).

▶ **LOW-SHOCK DRIVE**

The belt-drive transmission on the LX26 provides smooth operation, while minimizing the irritating shock and "chatter" of direct-drive mechanisms. When belt changing is required, no problem. The belt is tensioned in seconds by a single, easy-access tensioning ring between the motor and motor mount. You're back to work in a quick ten minutes.

▶ **LOW-MAINTENANCE**

For maximum enjoyment of your LX26, everything is designed for low maintenance. For example, the powder-coated chassis means superior rust-resistance compared to ordinary wet-coat paint. The cutter bearings are sealed for maintenance-free operation, as is the drive motor. Just lubricate the transmission chain, sprockets, and trapezoidal threaded bars, clean out wood debris, and keep cutting!

\* Optional second cutterhead required to plane beams wider than 19" (48 cm).

\*\* The maximum beam height when the Log Moulder LX26 is mounted to the HD38 or HD36V2 is 21" (53 cm); the maximum beam height when mounted to the LM30, LM29, MN27 or MN26 is 23.5" (60 cm). Maximum beam height will vary for other sawmill models depending on cross bunk vertical dimensions.





## LOG MOULDER LX26

# TAKE FULL ADVANTAGE OF YOUR SAWMILL'S MUSCLE

If you saw for profit, you'll position yourself as the exclusive "go to" source for premium, finished wood products unavailable anywhere else...

If you're an expert builder of custom homes, you'll be recognized and sought after as the designer of unique, award-worthy showpieces...

If you're a creative artist who takes pride in crafting fine furnishings & unique décor that are truly one-of-a-kind, you'll find it exciting how easily you can transform ordinary into extraordinary...

If you've always dreamed of building a log home, you'll discover how easily and beautifully this can now be accomplished.



## LX26 TECHNICAL DATA OVERVIEW

Length	40" (102 cm)
Width	65" (165 cm)
Height	41½" (105 cm)
Weight	450 lb (205 kg)
Lateral distance between carriage wheels (distance between log deck rails)	Variable: 31"–33½" (79 cm–85 cm) & 40½"–43" (103 cm–110 cm)

### CUTTERHEAD

Drum Length	8" (205 mm)
Drum Diameter	4 13/16" (122 mm)
Drum Speed	4680 RPM
Included Knives (with standard drum)	8" (205 mm) corrugated HSS planer
Lateral Adjustment (Max)	11" (28 cm)
Optional 2 <sup>nd</sup> Drum	8" x 4 13/16" (205 mm x 122 mm)
Knife Pattern Protrusion (Max)	1" (25 mm)
Moulding Depth (Max)	¾" (19 mm)



## CANT REST

### ITEM NO. LX26-REST

Optional log rests allow extremely accurate positioning of the log to the left and right of the sawmill. The result? Perfectly conjoined log profiles from end to end.

## KNIFE PROFILE PACKAGES

Unleash your creativity. Select from several optional shaped-knife packages to mould different log profiles. Fun and potentially profitable for you!



**6" x 8" TRADITIONAL D KNIVES (3 PAIR)**  
ITEM NO. LX26-KN-TD-6X8

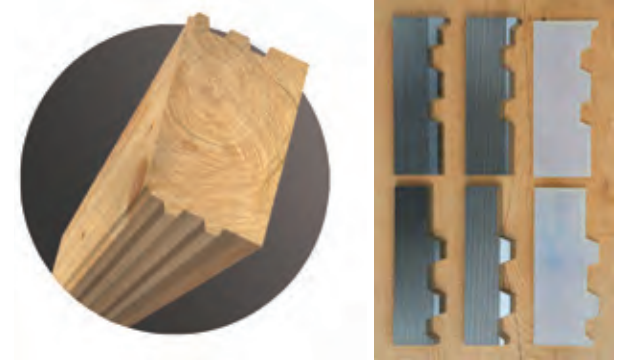

**6" TONGUE & GROOVE KNIVES (2 PAIR)**  
ITEM NO. LX26-KN-TD-SC-6



**6" SWEDISH COPE KNIVES (2 PAIR)**  
ITEM NO. LX26-SC-6



**8" SWEDISH COPE KNIVES (2 PAIR)**  
ITEM NO. LX26-SC-8

## CUTTERHEAD KIT

### ITEM NO. LX26-CH8

Add a second optional 8" (20 cm) cutterhead to plane beams and planks up to 16" (41 cm) in a single pass.

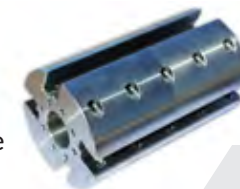



# LM30 & MN27 SERIES

OPTIONAL ATTACHMENTS & ACCESSORIES



**BOOST YOUR MILL'S  
CAPACITY.**

**EXPAND YOUR MILL'S  
FUNCTIONALITY.**

**GROW YOUR MILL'S  
PRODUCTIVITY.**

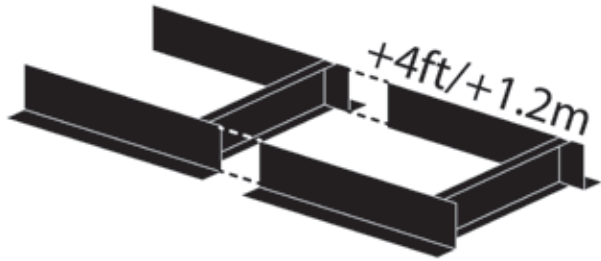

## 4-FOOT BED EXTENSION (1.2 M)

### ITEM NO. ML26-41130

Standard, the LumberMate LM30 and LumberMan MN27 mill up to 12' 8" (3.8 m) long. To mill logs nearly 17 feet (5.0 m), add a 4-foot (1.2 m) extension. Or, add as many extensions as you need to mill logs of any length. Each 4-foot extension bolts permanently to the end of the log deck.

*Note: Maximum of one 4-foot (1.2 m) extension permitted on trailer-equipped model. (Additional log rest/dog clamping assemblies sold separately.)*



## TOWING SYSTEM

A versatile towing system is available for the LM30 & MN27 – for off-road and public roads\*

See how you can customize your towing system ▶ Pages 64–65

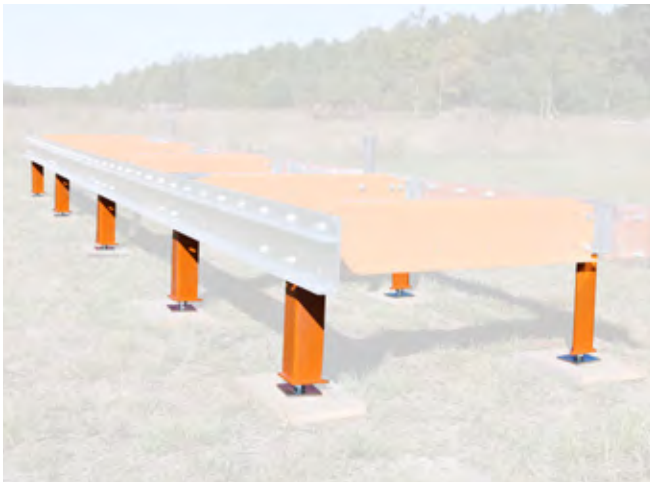

## LEVELING LEGS

### ITEM NO. LM29-41170

For stationary milling operations, support your Norwood LM30 or MN27 sawmills with a set of leveling stands custom-designed specifically to support your log deck.

Ten units per set. Supports standard 16-foot (4.8 m) log deck. Add a pair of leveling legs to support each 4-foot (1.2 m) bed extension. Two units (one pair) per set.

- ▶ Set of 10 (Item No. LM29-41170)
- ▶ Set of 2 (Item No. LM29-41170-14)



## LOG LOADING/ROLLING & RAMP PACKAGE

### ITEM NO. ML26-41400

Load and roll logs onto your LumberMate LM30 or LumberMan MN27 sawmill easier and more securely. Pass the winch cable over and around the log, connect it to the log deck frame and operate the winch—the log rolls up the ramps onto the bed.

It also makes rolling (rotating) the log on the bed a snap, and holds the log firmly for dogging. Enables one person to operate the mill alone easily.

Package includes two loading ramps, a 2-speed 1800 lb winch, mast/boom & receiver and log-rolling hook.



## ROLLER TOE BOARDS – MANUAL

### ITEM NO. LM29-41285

Trees are wider at the butt, making it hard to mill true lumber parallel to the heart of the log. Shimming is time-consuming hard work. Compensate for taper to mill true, high-value lumber fast and easy.

Choose the perfect height for each log thanks to the manual hydraulic bottle jack. Steel rollers make repositioning the log lengthwise along the bed easy.

Heavy-duty steel construction, double custom-fabricated steel rollers, and hydraulic cylinder assembly. Two toe board assemblies per set (approx. 50 lb (22 kg) per assembly).

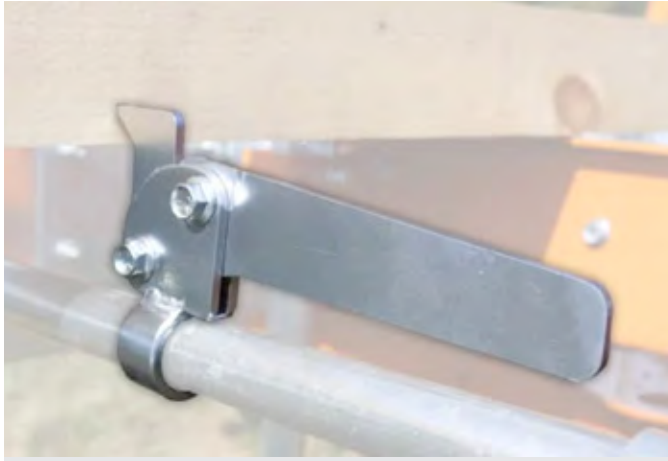

## CAM DOG KIT

### ITEM NO. LMMNV2-CD01

Ideal for instant clamping of squared cants and boards with a quick push of the handle. Use the standard log dog to clamp your log in the round, and the cam dog to clamp squared beams and lumber. The pick's blunt-nose design reduces marring of your valuable lumber. Clamp as low as 3/4" above bunk height.

## LOG-DOG/ LOG-REST KIT

### ITEM NO. LM29V2-DRKIT

Also available: additional complete log dog/rest clamping systems (one log dog/log rest station per set).



## AUTO BLADE LUBE SYSTEM

### ITEM NO. MILL-WLKIT

Automate the blade lubrication system on your LumberMate LM30 or LumberMan MN27 sawmill. Water automatically flows when you activate the throttle and stops when you release. Saves two operator functions for each board you cut.



*"I have a Norwood LM29. Great for the homestead. If you are looking for a mill for personal lumber and woodworking projects, this is the mill for you. Very easy to set up and great customer service."*

Jon Jones ★★★★★

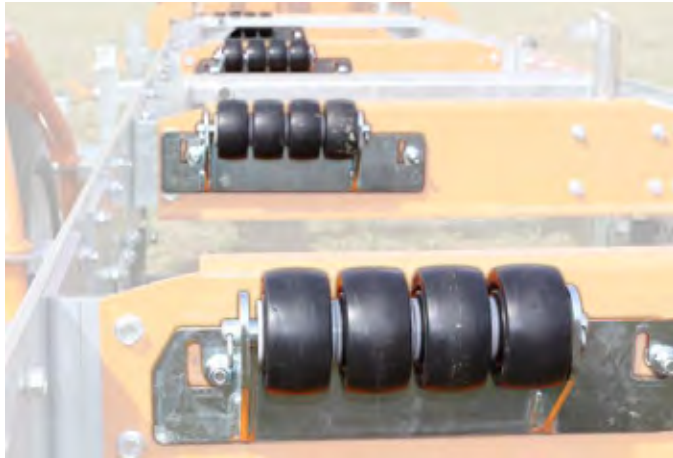

## BOARD OFFLOADING ROLLERS

### ITEM NO. 41287

Offload lumber fast and easy with a set of board offloaders. Push the fresh-sawn board or slab onto the bunk-mounted rollers, and shoot it down to the end of the bed for fast, efficient unloading and stacking.

Quickly retractable so there's zero interference when milling oversized logs and cants.

Four roller assemblies per set.



*The LumberMate LM29 is a well-built machine capable of churning out massive amounts of smooth straight lumber with a very short learning curve."*

Dan Rough, PA ★★★★★



## RAPID-DOGGING & ROLLING SYSTEM

### ITEM NO. 41295

If you mill mainly small to mid-sized sawlogs 6"–16" (15–40 cm) in diameter, this patented dogging and rolling system is engineered to save you time and hassle.

You'll find your sawlog is easy to turn — even by hand! Dogging is lightning fast thanks to the one-handed, single-action log dog clamps designed specifically to handle mid-size dimension logs.

Two units per set.

A Digital Scale is also available

▶ Page 74





## LAP SIDING & SHINGLE MAKING PACKAGE

### ITEM NO. 41270-MK2

Make shiplap siding and cedar-shake shingles quickly and easily. With this unique jig, cut lap-siding up to 9" (22.5 cm) wide, with taper widths down to a feather edge. Reconfigure the jigs and make cedar-shake shingles 9" (22.5 cm) wide and up to 16" (40 cm) long – each pass makes two shingles. Two jigs per set.

Tip: To double shingle production, add an extra set.

Note: Product photograph shows two Lap Siding & Shingle Making Packages (four jigs)



## SAW CARRIAGE COVER

Protect your LumberMate LM30 with a custom-made Norwood Sawmills cover. Made from the same rugged material used for transport truck covers – they're rip, rot & UV resistant. Tailored specifically for the LumberMate LM30 to fit snugly over the whole carriage.

### Available in two colors. It's your choice:

- Norwood Orange® (Item no. ML26-41290)
- Norwood Green (Item no. ML26-41290G)



My Norwood LM29 rocks! ... Thanks for making dreams come true!."

Dana Newton, MI ★★★★★



# LM30 & MN27 SERIES

OPTIONAL ATTACHMENTS & ACCESSORIES

TOWING & SUPPORT SYSTEMS



**BUILD YOUR TOWING SYSTEM TO  
MEET YOUR UNIQUE NEEDS**

Move your sawmill around your woodlot,  
or do you plan on towing it on roads\* to mill offsite?



## TREKKER® BASIC MOBILITY

### ITEM NO. LM29-41150-A

Whether you plan on trailering around your property, or down the highway\*, Trekker is the package to get you started. Includes the all-steel and powder-coated sub-frame structure including connecting brackets, a solid 1400 pound-rated single axle, two 12" wheels, quick-disconnect draw-bar, three additional cross bunks and 2" (50 mm) coupler. Accommodates standard 16-foot (4.8 m) log deck.

*Note: Before operating your sawmill on wheels, provide even and solid support along your log deck to the ground. Optional support jacks available (Item No. LM29-41150-C).*

*Note: Maximum total log deck length 20 feet (6 m) (i.e. maximum one 4-foot (1.2 m) extension) recommended on trailer-equipped sawmill, particularly when operated on public roads. Add a Sub-Frame Extension Kit (Item No. LM29-41150-D) for each bed extension (Item No. ML26-41130).*

\*Verify with your local vehicle licensing bureau/highway traffic regulations authority what licensing requirements and/or operational restrictions, if any, are applicable to towing the sawmill on public roads and highways in your jurisdiction. Some European jurisdictions prohibit towing the sawmill with the optional trailer package on public roads and highways or prescribe particular rules, requirements and limitations.



## ROAD KIT\*

### ITEM NO. LM29-41150-B

If you're planning on towing your sawmill on public roads in the US or Canada to mill lumber offsite, add this kit to your trailer system. Includes highway running lights, wiring harness, safety chains and custom-designed powder-coated steel fenders that quick-disconnect for easy sawing.

## SUB-FRAME EXTENSION KIT

### ITEM NO. LM29-41150-D

If you've extended your portable sawmill's log deck, you'll need to support each bed extension with a sub-frame extension kit. Includes 4-feet (1.2 m) of powder-coated steel sub-frame structure, connection brackets and hardware.



## SUPPORT JACK PACKAGE

### ITEM NO. LM29-41150-C

If you plan on frequently moving your sawmill from site to site, adjustable support jacks speed up set-up—Quickly and precisely level and support your log deck. Kit includes 6 adjustable jacks, mounting brackets and hardware to support the standard 16-foot (4.8 m)-long log deck.

If you have a longer log deck, add a Support Jack Extension Kit (Item No. LM29-41150-E) for each bed extension (ML26-41130).

## SUPPORT JACK EXTENSION KIT

### ITEM NO. LM29-41150-E

If you've extended your portable sawmill's log deck and you are also adding support jacks, you'll need to support each bed extension with a support jack extension kit. Includes 2 adjustable jacks, mounting brackets and hardware.

Two units per set.



# HD38 & HD36V2 SERIES

MANUAL OPTIONAL ATTACHMENTS & ACCESSORIES



**KEEP YOUR OPTIONS OPEN**

**YOU NEED A SAWMILL THAT WON'T HOLD YOU BACK**

Your sawmilling jobs will get bigger. Your sawmill has to keep up.  
Add manual, hydraulic and power functions to your machine anytime.



## 4-FOOT BED EXTENSION (1.2 M)

### ITEM NO. HD3X-41130

Standard, the HD38 and HD36V2 mill up to 13' (3.9 m) long. To mill logs 17 feet (5.1 m), add one 4-foot (1.2 m) extension. Or, add as many extensions as you need to mill logs of any length. Each 4-foot (1.2 m) extension bolts permanently to the end of the log deck.

*Note: Maximum of one 4-foot (1.2 m) extension permitted on trailer-equipped model. To mill longer, consider adding up to 2 detachable 2-foot (0.6 m) extensions (LM34-41140). (Additional log rest/dog clamping assemblies sold separately.)*

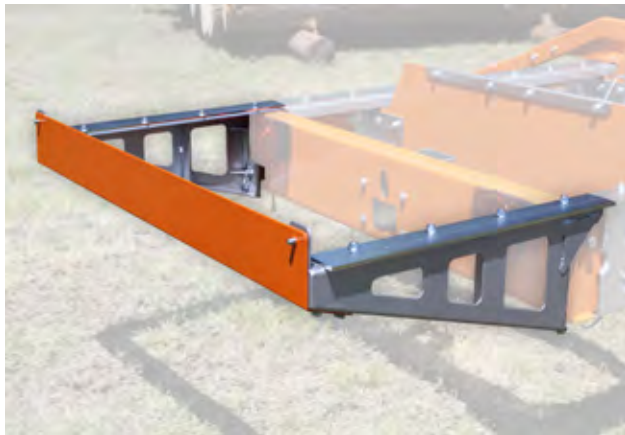

## 2-FOOT BED EXTENSION – DETACHABLE

### ITEM NO. LM34-41140

Mill longer logs without permanently extending your bed with an optional 2-foot (0.6 m) detachable extension. Especially useful to squeeze out extra milling capacity on the trailer-equipped HD38 or HD36V2. Secures to the log deck with quick-connect pins. Stow it conveniently out of the way when not in use.

Add a second detachable extension to get a full 4-feet (1.2 m) extra capacity.

*Note: Maximum of one 2-foot extension possible when mill equipped with power feed.*



## TRAILER/SUPPORT JACK PACKAGE

### ITEM NO. HD3X-41150

Tow your sawmill from job to job on highways\* and through your woodlot right to your milling site behind your ATV or pickup truck. When you get there, quickly and solidly level the log deck with the adjustable support outriggers. Package includes single, solid axle, 3000 pound-rated, reversible leaf springs, two 5-bolt full-size 13" galvanized wheels, highway running lights and wiring harness, safety chains, 2" (50 mm) coupler and 6 support jacks.

*Note: Maximum of one 4-foot bed extension (Item No. HD3X-41130) permitted on trailer-equipped model. Add a pair of support jacks to support optional 4-foot bed extension (Item No. LM34-SJ2)*

Verify with your local vehicle licensing bureau / highway traffic regulations authority what licensing requirements and/or operational restrictions, if any, are applicable to towing the sawmill on public roads and highways in your jurisdiction.

Some European jurisdictions prohibit towing the sawmill with the optional trailer package on public roads and highways or prescribe particular rules, requirements and speed limits.



## LEVELING STANDS

Ideal for the stationary sawmill, sturdy 9"-high stands (22.5 cm) deliver solid support and micro-adjust capabilities for more accurate set-up.

Add two leveling stands (1/5 set) to support each 4-foot bed extension.

- ▶ Set of 10 (Item No. LM34-41170)
- ▶ Set of 2 (Item No. LM34-41170-14)

*I bought the LumberPro HD36 and I can say that it was probably the best money I have ever spent in my life. The only attachment I bought was the log loader, but you can later get any of the attachments. All you have to do is plug-and-play as you add them on."*

Mark Gass ★★★★★

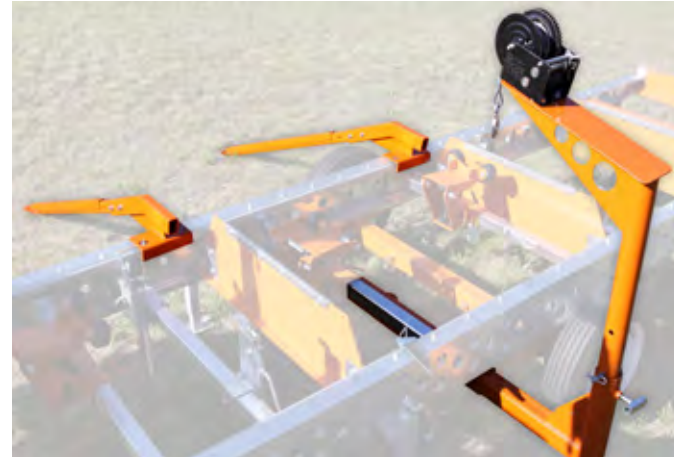

## LOG LOADING/ROLLING & RAMP PACKAGE

### ITEM NO. LM34-41400

A must for milling operations without access to hydraulics, heavy-lift loaders or forklifts. Load large logs onto your sawmill and hold them in place for quick dogging. Pass the winch cable over and around the log, connect it to the log deck frame and operate the winch – the log rolls up the ramps onto the bed. Also makes rolling the log on the bed a snap – speeds up squaring cants.

Package includes two loading ramps, a 2-speed 1 800 lb winch, mast/boom & receiver and log rolling hook.



## ROLLER TOE BOARDS— MANUAL

### ITEM NO. HD36-41285

Trees are wider at the butt, making it hard to mill true lumber parallel to the heart of the log. Shimming is time-consuming hard work.

Compensate for taper to mill true, high-value lumber fast and easy. Choose the perfect height for each log thanks to the manual hydraulic bottle jack. Steel rollers make repositioning the log lengthwise along the bed easy.

Heavy-duty steel construction, double custom-fabricated steel rollers, and hydraulic cylinder assembly. Two toe board assemblies per set (approx. 50 lb (22 kg) per assembly).

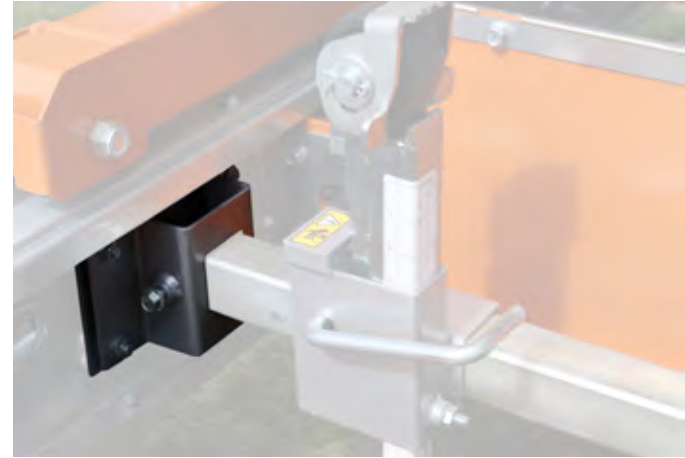

## LOG-DOG/LOG-REST RECEIVER SET

### ITEM NO. LM34-DRRCRKIT

Your HD38 or HD36V2 is equipped with two complete quick connect/quick-disconnect log-dog/log-rest assemblies. Each log clamping assembly nests securely in receivers permanently installed inside the log deck. Add extra receivers, and move your log clamps to different stations along your mill fast and easy. Each set includes two receivers (enough for one station) plus mounting hardware.

## LOG-DOG/ LOG-REST KIT

### ITEM NO. LM34-DRKIT

Also available: additional complete log dog/rest clamping systems (one log dog/log rest station per set).





## BOARD OFFLOADING ROLLERS

### ITEM NO. 41287

Offload lumber fast and easy with a set of board offloaders. Push the fresh-sawn board onto the bunk-mounted rollers, and shoot it down to the end of the bed for fast, efficient unloading and stacking.

Quickly retractable so there's zero interference when milling oversized logs and cants.

Four roller assemblies per set.



## RAPID-DOGGING & ROLLING SYSTEM

### ITEM NO. 41295

If you mill mainly small to mid-sized sawlogs 6"–16" (15–40 cm) in diameter, this patented dogging and rolling system is engineered to save you time and hassle.

You'll find your sawlog is easy to turn—even by hand! Dogging is lightning fast thanks to the one-handed, single-action log dog clamps designed specifically to handle mid-size dimension logs.

Two units per set.



*The Norwood HD36 does everything we need it to do. One of the best features of this mill is the ability to add accessories after the fact, keeping you within your budget on a premium mill, but able to add to your sawmill over time. You will cut some beautiful lumber with this mill!"*

"Seed to Saw" ★★★★★





## AUTOMATIC DOGGING ASSIST

### ITEM NO. 41289

Most logs are not perfectly round or straight and often have a mind of their own when rotating or clamping them.

Norwood's patented Automatic Dog Assists tame those logs by automatically following the log's contours when you rotate the log, and then holding the log exactly where you want it for easy dogging. Streamlines the typical two-handed, two-step dogging process into one smooth and easy step. Norwood is the only company that offers this convenient patented invention.

One unit per set.

*Note: Photo shows two Automatic Dogging Assists in use.*

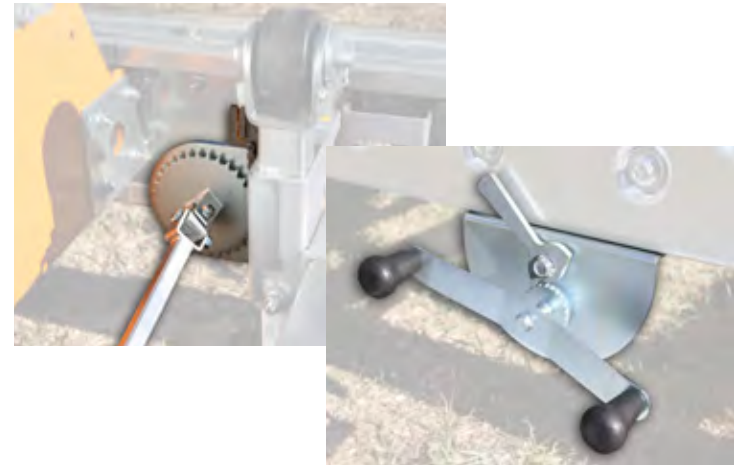

## LOG REST ACTUATORS

### ITEM NO. 41291

Easily access the log rests from the operator's side of the mill using Norwood's patented Log Rest Actuators and do away with reaching over the log to set the log rests.

The rack and pinion-type actuators allow for infinite adjustment, up or down. Simple to operate, just flip the lever and turn the handle. Norwood is the only company that offers the patented, time-saving log rest actuators.

Two units per set.

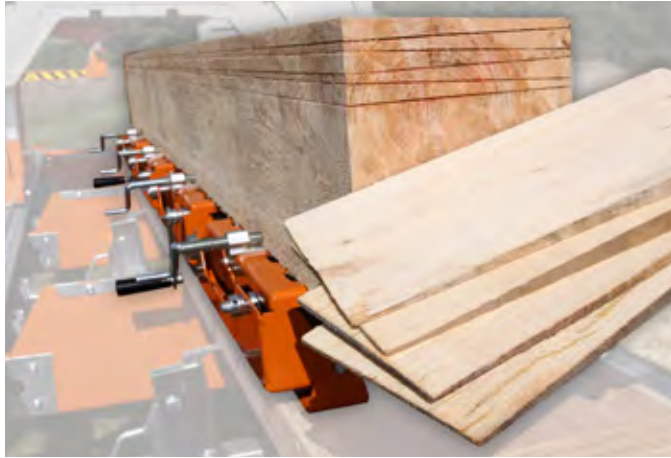

## LAP SIDING & SHINGLE MAKING PACKAGE

### ITEM NO. 41270-MK2

Make shiplap siding and cedar-shake shingles quickly and easily. With this unique jig, cut lap-siding up to 9" (22.5 cm) wide, with taper widths down to a feather edge. Reconfigure the jigs and make cedar-shake shingles 9" (22.5 cm) wide and up to 16" (40 cm) long – each pass makes two shingles.

Two jigs per set.

Tip: to double shingle production, add an extra set.

*Note: Product photograph shows two Lap Siding & Shingle Making Packages (four jigs)*



## SAW CARRIAGE COVER

Your HD36V2 is a valuable investment worth protecting. Norwood covers are made from the same rugged material used for transport-truck covers—they're rip, rot and UV-resistant. Tailored specifically for the LumberPro to fit snugly over the whole carriage.

### Available in two colors. It's your choice:

 Norwood Orange® (Item no. LM34-41290)

 Norwood Green (Item no. LM34-41290G)



*I love my Norwood HD36 mill. It is so much fun to make my own lumber and I can make it any size that I need it to be. It cuts like a hot knife through butter."*

Steve Mauro, NY ★★★★★

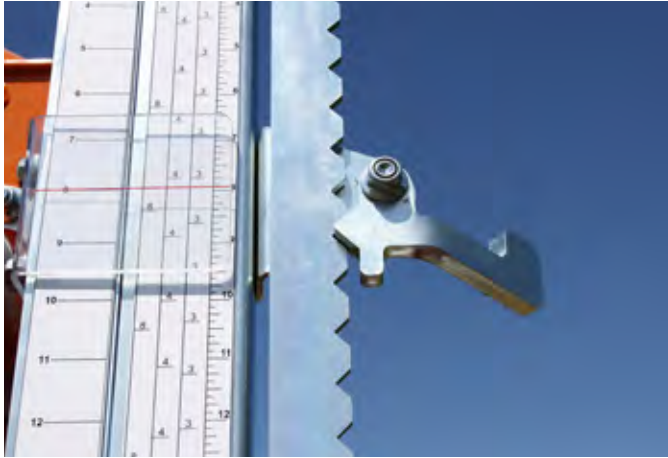

## QUICK-CLICK™ INDEXING DETENT NETWORKS— SCALES

A big time-saver when you're milling lots of dimensional lumber.

Quickly see your next depth mark—a weight/gravity indicator clicks into detents on specially-calibrated scales. Once you have the indicator system, select the scales that are right for your milling operation—the scales are available in various standard board-thickness increments.

- ▶ Quick-Click Indicator System (Item No. LM34-DSIND)
- ▶  $\frac{3}{4}$ " Detent Scale (Item No. HD3X-DS34S)
- ▶  $\frac{6}{4}$ " Detent Scale (Item No. HD3X-DS64S)
- ▶  $\frac{8}{4}$ " Detent Scale (Item No. HD3X-DS84S)
- ▶ 25 mm (1") Detent Scale (Item No. HD3X-DS25MM)



## LUMBER SCALE MAGNETS

Your sawmill comes standard with a 2", 9/8", 1" & 3/4" depth-of-cut scale with the kerf already calculated in. To mill specialty-sized boards, simply install one of the optional sets of magnetic scales calibrated with kerf allowance. When you want to mill standard lumber again, just peel them off and store them for later use. Each pair includes the primary and secondary scales.

Optional metric scale sets are also available.

- ▶ 9/4", 6/4", 5/4" & 9/8" scale (Item No. LM34-LS-94KIT)
- ▶ 5 cm, 4 cm & 2 cm scale (Item No. LM34-LS-CMKIT)
- ▶ 28, 41, 55 & 106 mm scale (Item No. LM34-LS-DEDC8 (primary scale only))



## LIGHTING KIT

### ITEM NO. HD36-41900

Light up your sawmilling site.

Two large 36 W LED flood lights mounted to your top frame blast light down on your log deck, a medium-sized LED focuses light on your blade in the cut, and a fourth LED shines on your depth of cut scale. Kit comes complete with four IP67 waterproof LED lights, a custom wiring harness with relay, an ON/OFF switch and a waterproof fuse holder.

There is no substitute for working safely in full daylight or with good overall site lighting, but the lighting kit can dramatically improve your operational visibility.

*Note: Cannot be used in combination with the power feed, power sawhead or setworks systems on the HD36V2.*



## DIGITAL SCALE

### ITEM NO. 41297

Accurately digitally measure your depth-of-cut to within +/- .03". Simplifies adjusting your depth-of-cut – a quick glance at the reading on the LCD display will show you the position of your blade. One input allows you to quickly switch between reading “Absolute” and “Relative” values:

- ▶ The Absolute value shows you the distance from the top of the cross bunk (bottom of the cant) to the blade. The “Absolute” value is set once and it will never be lost. You can, however, re-adjust it if needed.
- ▶ The Relative value shows you the displacement in real time of your blade without having to do any calculation (subtraction). To adjust the blade to the proper height for your next cut, reset the Relative value to zero and move your blade down to the desired board thickness (Note: You do have to account for kerf).

Can be configured in imperial (standard) or metric. Kit includes a sensor, adhesive magnet strip, adhesive magnet protection strip, LCD read-out display, brackets, two AA batteries and fasteners.

*Note: Cannot be used in combination with the power feed, power sawhead or setworks systems on the HD36V2.*

*Note: For HD38, HD36V2, HD36, LM30, LM29, MN27, MN26, MX34, or ML26.*





# HD38 & HD36V2 SERIES

HYDRAULIC & POWER OPTIONAL ATTACHMENTS

**TAKE YOUR MILL TO THE MAX**

**HARNESS THE MUSCLE OF HYDRAULICS  
& PRODUCTION FROM POWER**

Your HD38 or HD36V2 will step up when the logs get bigger, the deadlines shorter, and the loads heavier—  
To give you the ultimate freedom to take your milling operation in any direction... anytime.

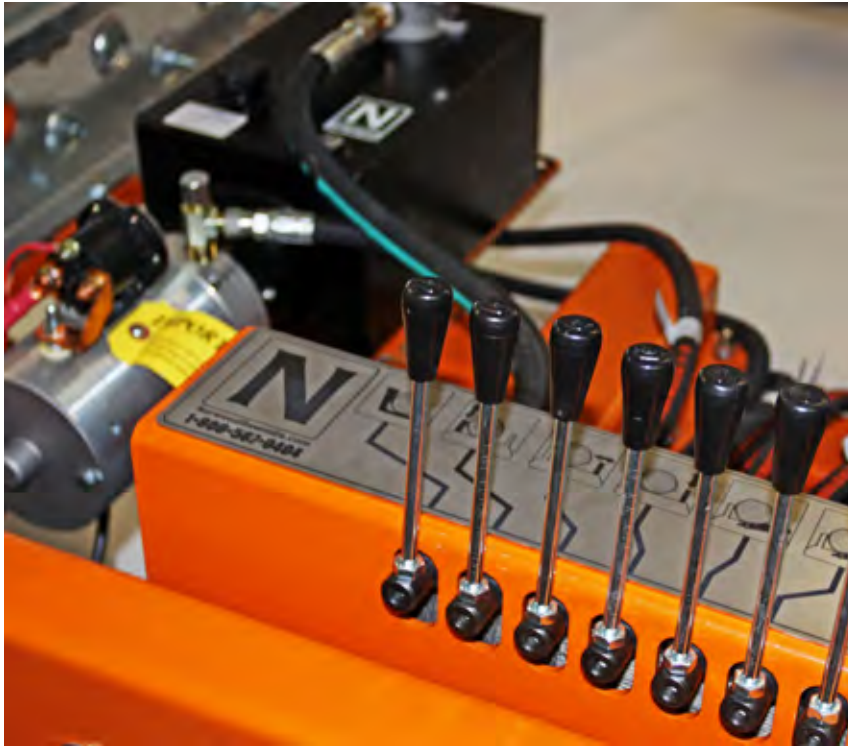

## HYDRAULIC PUMP SYSTEMS

Power all your hydraulic attachments with either the optional integrated or the auxiliary hydraulic pump system.

Both systems deliver reliable power to all your hydraulic log-handling attachments—log loaders, log clamping, log turner and toe boards.

Picking the right power system for you depends on your operation. Powering the hydraulic pump integrated with the sawmill engine eliminates the noise and hassle of an independent pump powered by a separate engine.

Powering the hydraulic pump with a separate (auxiliary) engine simplifies the system and provides constant and uninterrupted flow to all of the hydraulic attachments.

The integrated hydraulic pump system comes complete with the auxiliary alternator system & housing, hydraulic pump, deep-cycle/high-capacity battery, standard 8-section valve-body, hydraulic hoses & fittings, mounting brackets and hardware. (Briggs & Stratton gas engine required; 23 hp model recommended.) (Item No. LM34-HD-P1)

The auxiliary hydraulic pump system comes complete with gas engine, the hydraulic pump, standard 8-section valve-body, hydraulic hoses & fittings, mounting brackets and hardware. (Item No. LM34-HD-P4)



## HYDRAULIC LOG LOADERS

### ITEM NO. LM34-HD-41400

Load logs onto your log deck with a simple flick of a lever. The hydraulic log loaders can handle logs nearly 3000 lb (1360 kg). Steel “spans” automatically drop down to bridge the gap between the loaders and your bed, and help protect your track.

Engineered for easy removal for safe trailering, you can quickly remove the loaders from your mill in just minutes thanks to the quick-connect/disconnect pins and hydraulic fittings. The same quick-connect system means you can reinstall the loaders in just as little time.

The hydraulic log loader requires the power hydraulic pump system.



## HYDRAULIC LOG CLAMPING SYSTEM

### ITEM NO. LM34-HD-41600

Clamp logs with vise-like power with this combined hydraulic log rests and hydraulic log dog system. Raise and lower the twin log rests, simultaneously, simply by operating a single lever. Built of precision laser cut  $\frac{3}{4}$ " (19 mm) steel, they can travel up to  $12\frac{1}{2}$ " (32 cm) above the log deck to clamp full-size logs, and down as low as  $\frac{7}{8}$ " (22 mm) above the log deck to mill boards within 1" (2.5 cm) of the bed.

The four-way acting, dual-function, log dog not only gives you the dexterity, and power, to securely clamp even the biggest logs, the integrated four-way acting log dog can also be used to manipulate and turn cants. Because the log dog is not suitable for turning logs in the round, consider equipping your Pro with the hydraulic log turner to roll logs into position for the first, second and third cuts.

The hydraulic log clamping system requires the power hydraulic pump system.





## HYDRAULIC ROLLER TOE BOARDS

**ITEM NO. HD36-HD-41285**

Compensate for the natural taper in your logs with toe boards. Increase lumber yield, and increase the quality of your boards, by keeping the face of your cuts parallel to the grain. This is especially important when milling for grade. Each hydraulic roller toe board is equipped with a powerful hydraulic cylinder that can lift full-size logs up to 3½" (9 cm). A pair of roller toe boards also makes repositioning logs along the mill easier thanks to rugged integrated steel rollers.

The hydraulic roller toe boards require the power hydraulic pump system.

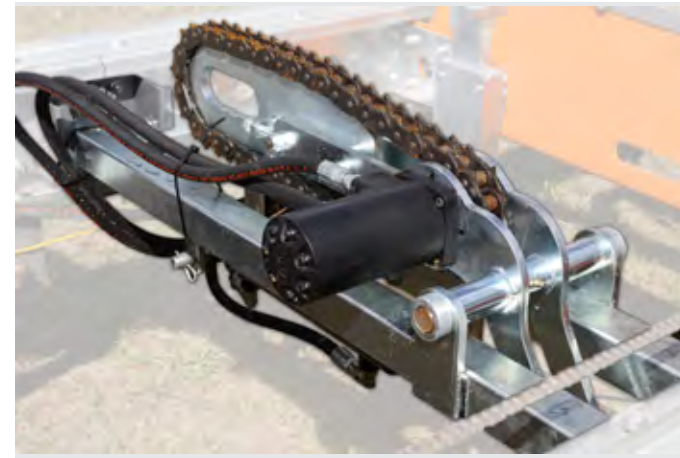

## HYDRAULIC LOG TURNER

**ITEM NO. LM34-HD-41500**

Rolling big logs is virtually effortless with the hydraulic log turner.

A hydraulic cylinder and hydraulic motor give you separate control of vertical and rotation functions. Features dual-direction rotation—turn your log in either direction. Equipped with deep-toothed chain, the log turner bites hard into gnarly bark to maximize traction. Use the log turner to roll logs into position for the first, second and third cuts.

The hydraulic log turner requires the power hydraulic pump system.



## POWER FEED & POWER SAWHEAD

Intuitively and effortlessly operate 5 functions on your sawhead from a single wireless hand-held remote control: Set the depth-of-cut; control the throttle; activate the blade lube system; power the blade through the cut; and adjust the feed rate... all while standing safely up to 30 feet (9 m) behind your mill.

Controlled by a 2-way toggle switch on the remote, the power drive motor with chain-drive system positively powers your saw carriage along the log deck through the cut and back. The control panel is programmed to deliver smooth transitions: Stop «» Forward, Stop «» Reverse, and Forward «» Reverse. A second toggle switch allows you to smoothly raise and lower the sawhead at your optimal speed.

With Norwood's power system, you keep control over your cut – Adjust your feed rate on-the-go thanks to the speed potentiometer dial integrated into the remote control... speed up or slow down as you are cutting so you don't sacrifice quality for convenience.

Recharge the wireless radio protocol remote control via a USB during operation or after. Plug and play control panel cabling simplifies set-up.

Mill	System	Power Feed	Power Sawhead	Control Panel	Wireless Remote	Item No.
HD38	Power Feed System	✓	Standard with HD38	✓	✓	HD38-5000
HD36V2	Power Feed & Power Sawhead System	✓	✓	✓	✓	HD36-5000

Compatible with Norwood's IntelliSet® professional-grade networks so you can easily and economically upgrade anytime with our conversion kit (Item No. HD3X-5000-SW-C).



## BOARD RETURN

### ITEM NO. LM34-PSH-5010

If your HD36V2 is equipped with the remote-controlled power sawhead, you can boost production even more by equipping your mill with the board return system.

When you power the carriage back after making a cut, the steel drag-back fingers firmly, and steadily, return the board to the head of the mill... Just direct each board into your waiting trailer or lumber pile.

*Note: Not available for HD38.*

## POWER SAWHEAD ONLY

### ITEM NO. LM34-PSH-5030

Powers your depth-of-cut adjustment only. (Not for HD38)



## POWER FEED CHAIN KIT

### ITEM NO. LM34-PSH-5020

Add a chain kit for each 4-foot bed extension.



# INTELLISET® COMPUTER NETWORKS

Boost your output with Norwood's IntelliSet professional-grade computer networks with programmable blade height control and convenient wireless remote-control onboard functionality. It looks after the complex, so you can focus on the reward.

IntelliSet pairs all 5 functions from the power feed/power sawhead system with intelligent programming that handles all the math calculations for you.

Control IntelliSet from the full-function handheld wireless controller that includes a built-in 5" (13 cm) TFT color display, 4-way momentary joystick switch, throttle control and adjustable speed control. Its custom-designed housing is easy to grip by real-life working hands.

IntelliSet features 6 task modes to quickly and accurately calculate and control blade height referenced from your last cut or based on your finished product objectives. In all modes, after each cut, the computer raises the sawhead and blade clear above the log to safely return to the starting point.

Program up to 16 pre-set board/beam thicknesses in 4 of the 6 modes (each mode can have its own unique pre-sets); reprogram your pre-sets anytime.

- ▶ **Down Cut Mode:** Quickly position the sawhead when milling the same sized boards. Select from up to 16 pre-set board thicknesses you program for this mode. Mark the blade location to give the computer its original point of reference. Then, simply tap the joystick down to automatically lower the blade height to cut your next board to your programmed thickness.
- ▶ **Up Cut Mode:** Ideal for raising the sawhead when you are looking to make large incremental cuts. Select from up to 16 pre-set board thicknesses you program for this mode. Mark the blade location to give the computer its original point of reference. Then, simply tap the joystick up to automatically raise the blade height to cut your next board to your programmed thickness.
- ▶ **Standard IntelliCut:** Optimize board production when sawing cants and minimize your log waste when sawing the same board thickness



throughout the cant. Tell the computer what you want; select from up to 16 pre-set board thicknesses you program for this mode. IntelliSet does the math for you and, referencing from the bottom of the cant, automatically calculates your first cut and sets the blade height for all cuts down to the last board.

- ▶ **Custom IntelliCut:** Optimize board production when sawing cants and minimize your log waste when sawing different board thicknesses from the same cant. Tell the computer what you want; select from up to 4 pre-set board thickness patterns you program for this mode. IntelliSet does the math for you and, referencing from the bottom of the cant, automatically calculates your first cut and sets the blade height for all cuts down to the last board.
- ▶ **Go-To Mode:** Quickly command the sawhead and blade to move to (go-to) one of up to 4 pre-set waypoint heights you have programmed in.
- ▶ **Manual Mode:** Bypass the computer and set the blade height manually referencing the digital blade height display on the wireless controller.

Custom program your IntelliSet to your preferred settings:

- ▶ Language
- ▶ Time
- ▶ Blade kerf
- ▶ Units: Display blade height in Imperial (decimal or fraction) or Metric (decimal)
- ▶ 5 or 16 pre-set board/beam thicknesses in 4 modes

IntelliSet's wireless controller has a range of up to 30 feet (9 m) and is rechargeable via a USB during operation or after. Its display automatically shows battery status.

*Expected availability: Summer 2021.*

Mill	Networks	Power Feed	Power Sawhead	Control Panel	IntelliSet Remote	Item No.
HD38	IntelliSet Networks (complete)	✓	Standard with HD38	✓	✓	HD38-5000-SW
HD36V2	IntelliSet Networks (complete)	✓	✓	✓	✓	HD36-5000-SW
HD38, HD36V2	IntelliSet Networks (conversion upgrade)				✓	HD3X-5000-SW-C



## DEBARKER

### ITEM NO. HD36-PDB-41700

Removing dirt and small rocks embedded in the bark ahead of the cut reduces blade dulling. This improves performance, speeds up cutting and increases time between sharpening (meaning less time and money spent on blade maintenance).

Norwood's unique debarker design mounts the 12 V, ½ hp motor on the sawhead platform, positioning its weight directly in line with the sawhead's vertical up/down plane of movement. This innovative system eliminates the imbalanced forces inflicted on sawheads by traditional direct-drive debarkers where the motor's heavy weight hangs cantilevered out in front of the blade.

The motor's torque is remotely transmitted to the triple-stacked 5 ½" (14 cm) carbide-tipped circular blades on the debarker head via a high-strength flexible shaft. Stackable blades permit pre-cutting up to 3/8" (9.5 mm) wide.

Linearly adjustable, the debarker accommodates logs 10" (25 cm) to 36" (92 cm) in diameter. Quickly remove the debarker head for safe storage or transport—simply disconnect the flexi-shaft and a couple of wires. The easily accessible control box features an audible warning sound when the system is ON.

*Note: Not available for HD38.*

# CUSTOMIZE YOUR MILL WITH HYDRAULIC OR MANUAL OPTIONS



# TECHNICAL DATA

## LumberMax HD38

Manual or Hydraulic Band Sawmill

## LumberPro HD36V2

Manual or Hydraulic Band Sawmill

## LumberMate LM30





Manual Band Sawmill

## LumberMan MN27

Manual Band Sawmill

## PortaMill PM14

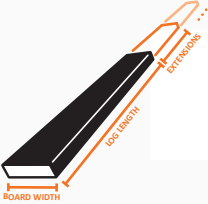
Chainsaw Sawmill

 <p><b>LOG DIAMETER</b> (max)</p>	38" (97 cm)	36" (92 cm)	30" (76 cm)	27" (69 cm)	14" (35 cm)
 <p><b>WIDTH OF CUT</b> (max slab width)</p>	35" (89 cm)	31" (79 cm)	25" (64 cm)	23" (59 cm)	14" (35 cm) (if using 24" (61 cm) bar)
<p><b>BOARD WIDTH</b> (STANDARD)</p>	32" (81 cm)	30" (76 cm) (28" (71 cm) in hydraulic configuration)	24" (61 cm)	23" (59 cm)	8" (20 cm)
 <p><b>LOG LENGTH</b> (standard)</p>	13' (4 m)	13' (4 m)	12'9" (3.8 m)	12'9" (3.8 m)	Depends on ladder length (customer-supplied) 7½' (2.3 m) with optional track
 <p><b>EXTENSION</b> (standard)</p>	4' (1.2 m) 2' (0.6 m)	4' (1.2 m) 2' (0.6 m)	4' (1.2 m)	4' (1.2 m)	5' (1.5 m) for optional track
 <p><b>POWER OPTIONS</b></p>	<ul style="list-style-type: none"> <li>▶ 23 hp (627 cc) Briggs V-Twin Vanguard OHV electric-start engine</li> <li>▶ 15 hp electric motor (11 kW, 230/400 V, 3 Ph, 50 Hz) (Europe)</li> </ul>	<ul style="list-style-type: none"> <li>▶ 18 hp (570 cc) Briggs V-Twin Vanguard OHV electric-start engine</li> <li>▶ 23 hp (627 cc) Briggs V-Twin Vanguard OHV electric-start engine</li> <li>▶ 10 hp electric motor (7.5kW, 230V, 1Ph, 60Hz)</li> <li>▶ 15 hp electric motor (11kW, 230/460V, 3Ph, 60Hz)</li> <li>▶ 10 hp electric motor (7.5kW, 400V, 3Ph, 50Hz) (Europe)</li> <li>▶ 10 hp electric motor (8kW, 230/400V, 3Ph, 50Hz) (Europe)</li> <li>▶ 15 hp electric motor (11kW, 230/400V, 3Ph, 50Hz) (Europe)</li> </ul>	<ul style="list-style-type: none"> <li>▶ 13½ hp (420 cc) Briggs &amp; Stratton electric-start gas engine</li> <li>▶ 14 hp (429 cc) Kohler OHV recoil-start engine</li> <li>▶ 13 hp (390 cc) Honda GX-Series OHV recoil-start engine</li> <li>▶ 18 hp (570 cc) Briggs V-Twin Vanguard OHV electric-start engine</li> <li>▶ 10 hp electric motor (7½kW, 400V, 3Ph, 50Hz) (Europe)</li> <li>▶ 10 hp electric motor (8kW, 230/400V, 3Ph, 50Hz) (Europe)</li> <li>▶ 7½ hp electric motor (5½kW, 400V, 3Ph, 50Hz) (Europe)</li> </ul>	<ul style="list-style-type: none"> <li>▶ 13½ hp (420 cc) Briggs &amp; Stratton recoil-start gas engine</li> <li>▶ 5½ hp electric motor (4kW, 230v, 3Ph, 50Hz) (Europe)</li> <li>▶ 5½ hp electric motor (4kW, 400V, 3Ph, 50Hz) (Europe)</li> <li>▶ 7½ hp electric motor (5½kW, 400V, 3Ph, 50Hz) (Europe)</li> </ul>	<p>Customer-supplied chainsaw</p> <p>(Min &gt;50 cc for small-mid-sized logs)</p> <p>(Min &gt;65 cc for mid-large-sized logs)</p>

**LumberMax  
HD38**

Manual or Hydraulic  
Band Sawmill

**LumberPro  
HD36V2**

Manual or Hydraulic  
Band Sawmill

**LumberMate  
LM30**

Manual  
Band Sawmill

**LumberMan  
MN27**

Manual  
Band Sawmill

**PortaMill  
PM14**

Chainsaw  
Sawmill

<b>DEGREE OF CUSTOMIZABILITY</b> (see below for optional attachments)	Very High (hydraulic-capable)	Very High (hydraulic-capable)	High	High	Low
<b>LOG DECK LENGTH</b> (standard before optional extensions)	16' (4.8 m)	16' (4.8 m)	16' (4.8 m)	16' (4.8 m)	Depends on ladder length (customer-supplied) 10' (3 m) optional track
<b>LOG DECK EXTENSIONS</b> (unlimited in stationary configuration)	4' (1.2 m) 2' (0.6 m)	4' (1.2 m) 2' (0.6 m)	4' (1.2 m)	4' (1.2 m)	5' (1.5 m) for optional track
<b>WIDTH</b> (at widest point on sawhead)	6'11" (2.1 m)	6'7" (2 m)	6'6" (2 m)	6'6" (2 m)	4'8" (1.4 m)
<b>CARRIAGE</b>	Rigid 4 post	Rigid 4 post	Rigid 4 post	Rigid 4 post	Cantilevered
<b>BLADE LENGTH</b>	167"	167"	144"	144"	Maximum 24" (61 cm) bar with ripping chain (customer-supplied)
<b>SET DISPLAY</b> (standard)	2", 9/8", 1", 3/4"	2", 9/8", 1", 3/4"	2", 9/8", 6/4", 1", 3/4"	2", 9/8", 6/4", 1", 3/4"	2", 1" and user scale/ 40, 27, 15 mm
<b>SET DISPLAY</b> (optional)	9/4", 6/4", 5/4", 9/8" 5, 4, 2 cm 28, 41, 55, 106 mm	9/4", 6/4", 5/4", 9/8" 5, 4, 2 cm 28, 41, 55, 106 mm	152, 114, 76, 50, 25 mm	152, 114, 76, 50, 25 mm	
<b>DRIVE</b>	Centrifugal clutch	Centrifugal clutch	Centrifugal clutch	Centrifugal clutch	
<b>BANDWHEELS</b>	19" x 5/8" (47.5 x 1.5 cm)	20¼" x 7/8" (50.6 x 2.2 cm)	19" x 5/8" (47.5 x 1.5 cm)	19" x 5/8" (47.5 x 1.5 cm)	
<b>HYDRAULIC-CAPABLE</b> (upgradeable with hydraulic & power modules)	Yes	Yes			

Specifications are as accurate as known at the time of publication but are subject to change without notice.



**HD38**

**HD36V2**

**LM30**

**MN27**

**PM14**

Auto-Locking Sawhead (infinitely-adjustable)	●	●	●	●	
Laminated Sawhead and EZ Blade-Tension System	●	●	●	●	
Omega® Deep-Throat Sawhead	●				
Auto 1" (2.5 cm) Indexing (1 SH handle revolution = 1")		●	●	●	
Power Sawhead (Up/Down Only)	●	■			
Duradeck® Log Deck	●	●			
Ergonomic Tilt-Height Operator's Station	●	●	●	●	
Single-Action, Multi-Function Operator's Control	●	●	●	●	
Automatic ON/OFF Blade Lube System	●	●	■	■	
Manual Blade Lube System			●	●	
Auto-Locking Adjustable Blade Guide	●	●	●	■	
4-Axis Guides with Dual Roller & Lower Ceramic: Adjustable/Fixed	●				
Ceramic Blade Guides: Adjustable/Fixed		●	■	■	
Roller Blade Guides: Adjustable/Fixed			●	■	
Roller Blade Guides: Dual Fixed				●	
Stainless Steel Bunk Covers	●	●			
Movable Log Clamping Stations (with available extra receivers)	●	●			
Quick-Set Auto-Locking Log Rests	●	●			
Laterally-Adjustable Log Rests	●	●			
Quick-Lock Cam Dog	●	●	■	■	
Leveling Feet			●	●	
Powder-Coat Finish	●	●	●	●	
Sawdust exhausts at far side (away from operator)	●	●	●	●	
Log Moulder LX26-Compatible (log planer & moulder)	Yes	Yes	Yes	Yes	

**MANUAL & EXPANSION ATTACHMENTS**

Chain & Bar Oiler Kit					■
Cross Bunk & Log Clamping Assembly (supplemental)					■
Track System: 10' (3 m)					■
Track Extensions: 5' (1.5 m) Permanent					■
Bed Extensions: 4' (1.2 m) Permanent	■	■	■	■	
Bed Extensions: 2' (0.6 m) Detachable	■	■			
Trailer System & Support Jacks (for mobile operations)	■	■	■	■	
Support Stands (for stationary operations)	■	■	■	■	



HD38

HD36V2

LM30

MN27

Log Loader/Rolling & Ramp System	■	■	■	■
Roller Toe Boards	■	■	■	■
Lap Siding & Shingle-Making Jigs	■	■	■	■
Board Offloading Rollers	■	■	■	■
Rapid-Dogging & Rolling System	■	■	■	■
Log Clamping Assemblies (supplemental)	■	■	■	■
Log Clamping Station Receivers (supplemental)	■	■		
Cam Dog	●	●	■	■
Automatic Dogging Assist	■	■		
Log Rest Actuators	■	■		
Adjustable Blade Guide	●	●	●	■
Dura-Guide® Ceramic Blade Guides	■	●	■	■
Automatic ON/OFF Blade Lube System	●	●	■	■
Digital Scale	■	■	■	■
Quick-Click® Indexing Detent Setworks		■		
Lighting Kit	■	■		
Carriage Cover (orange or green)	■	■	■	■
<b>HYDRAULIC &amp; POWER ATTACHMENTS</b>				
Log Moulder LX26 (log planer & moulder)	■	■	■	■
Hydraulic Pump System (integrated)	■	■		
Hydraulic Pump System (auxiliary 5 hp gas-powered)	■	■		
Hydraulic Pump System (electric 230/400 V, 3 Ph, 50 Hz)	■	■		
Hydraulic Log Loaders (hydraulic loading arms)	■	■		
Hydraulic Roller Toe Boards	■	■		
Hydraulic Log Turner (chain turner)	■	■		
Hydraulic Log Clamps	■	■		
Power Sawhead (Up/Down)	●	■		
Power Feed	■	■		
IntelliSet® Computer Setworks	■	■		
Board Return (requires power feed)		■		
Debarker (pre-cutter)		■		



**STANDARD**

*IT'S RIGHT  
IN THE PACKAGE!*



**OPTIONAL**

*IT'S READY TO GROW  
WHEN YOU NEED IT!*

*THESE UPGRADES  
CAN BE ADDED  
AT ANY TIME.*





# START BUILDING *YOUR* CUSTOMIZED **LUMBERMAN MN27** OR **LUMBERMATE LM30** JUST FOLLOW THESE SIMPLE STEPS...

## 1 Choose Your Mill and Power

### LUMBERMAN MN27

#### Standard Power

- 13½ hp (420 cc) Briggs

### LUMBERMATE LM30

#### Pick Your Power

- 13 hp (389 cc) Honda
- 13½ hp (420 cc) Briggs electric start
- 14 hp (429 cc) Kohler
- 18 hp (570 cc) V-Twin Briggs electric start

## 2 Choose Your Mill Configuration

### TRAILER NEEDS

*Do you want to set up your mill in one place?*

- Support Legs:** Solid support for your permanently installed mill.

*Do you want to trailer your mill to your milling site or on highways?*

- Trailer System Modules**

### LOG LENGTH

*Do you want to mill logs and lumber longer than 12'9"?*

- 4 ft Bed Extensions:** Additional length of the same rigid rail system as your mill. Go as long as you want in a fixed application.

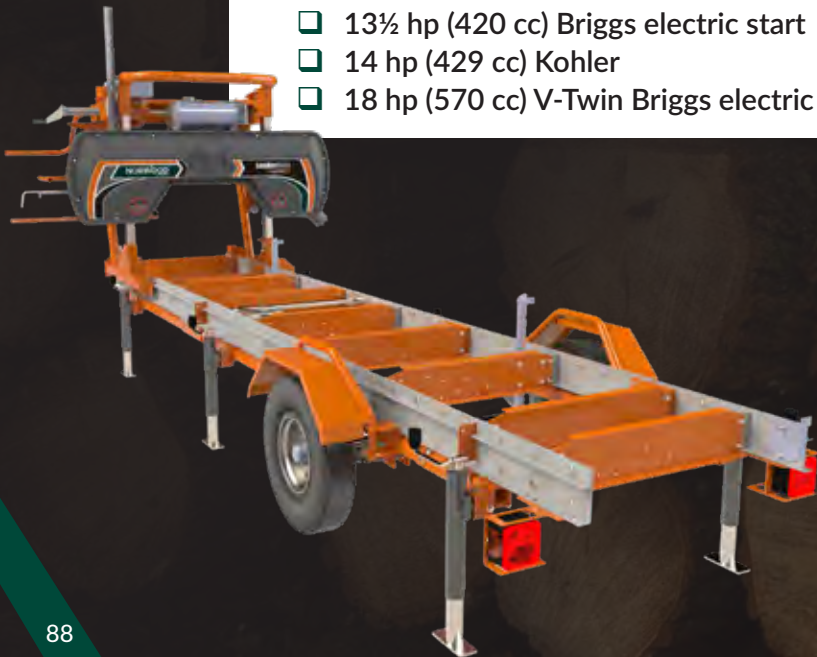

3

### Choose Your Extra Functions

#### LOG-HANDLING

*Do you want to make loading and rolling logs easier?*

- Log Loading, Rolling & Ramp System (manual)

*Do you want to raise the narrow end of logs to compensate for taper and easily roll your log lengthwise?*

- Roller Toe Boards (manual)

#### PRODUCTION BOOSTERS

*Do you want to clamp cants and boards fast?*

- Cam Dog

*Do you want to unload boards fast and easy?*

- Board Offloaders: Roll boards to the end of the bed for quick offloading and stacking.

4

### Choose Your Board Finish and Mill Storage

*Do you want to make lap siding and/or shingles?*

- Lap Siding/Shingle Maker System

*Do you want to protect your investment from the elements?*

- Carriage Covers: Norwood Orange or Green.

*Do you want to plane and mould your logs?*

- Log Moulder LX26: Precisely shape and plane beams and oversized boards with maximum efficiency, right on your sawmill.



#### DON'T FORGET

You can add any of these options at any time!

▶ SEE PAGES 58-65



# START BUILDING *YOUR* CUSTOMIZED **LUMBERMAX HD38** OR **LUMBERPRO HD36V2** JUST FOLLOW THESE SIMPLE STEPS...

## 1 Choose Your Power and Mill Configuration

### LUMBERMAX HD38

#### Pick Your Power

- 23 hp (627 cc) V-Twin

*(Other power options available for international markets.)*

### LUMBERPRO HD36V2

#### Pick Your Power

- 23 hp (627 cc) V-Twin
- 18 hp (570 cc) V-Twin
- 15 hp (11 kW) electric
- 10 hp (7½ kW) electric

*(Other power options available for international markets.)*

### TRAILER NEEDS

Do you want to set up your mill in one place?

- Leveling Stands:** Solid support for your permanently installed mill.

Do you want to trailer your mill on highways and to your milling site?

- Trailer/Support Jack Package**

### LOG LENGTH

Do you want to mill logs and lumber longer than 13'?

- 4 ft Bed Extensions:** Additional length of the same rigid rail system as your mill. Go as long as you want in a fixed application.
- 2 ft Detachable Extensions:** Perfect for adding extra length that you can quickly remove for safer trailering.

## 2 Choose Your Manual Functions

### LOG-HANDLING

Do you want to make loading and rolling logs easier?

- Log Loading, Rolling & Ramp System** (manual)

Do you want to raise the narrow end of logs to compensate for taper and easily roll your log lengthwise?

- Roller Toe Boards** (manual)

Do you want to speed up rolling and clamping small logs?

- Rapid Dogging & Rolling System**

Do you want an “extra set of hands” to help hold the log in place when you rotate it?

- Log Dog Assist**

### PRODUCTION BOOSTERS

Do you want to set depth-of-cut fast to speed up milling dimensional lumber?

- Quick-Click Scales:** Available in all of the most popular dimensions. (HD36V2 only)

Do you want to unload boards fast and easy?

- Board Offloaders:** Roll boards to the end of the bed for quick offloading and stacking.

3

## Choose Your Hydraulic and Power Functions

### LOG-HANDLING

*Do you want to make loading and rolling logs easier?*

- Hydraulic Log Loading System

*Do you want to raise the narrow end of logs to compensate for taper?*

- Hydraulic Toe Boards

*Do you want to make rolling logs easier?*

- Hydraulic Log Turner

*Do you want to clamp logs fast?*

- Hydraulic Log Clamping

### PRODUCTION BOOSTERS

*Do you want to set depth-of-cut fast and power the carriage feed?*

- Setworks, Power Head & Carriage: Operate all functions from a single digital control panel.

*Do you want to unload boards fast and easy?*

- Board Return: Works with the powered carriage to drag boards to the end of the bed for quick unloading and stacking. (HD36V2 only)

4

## Choose Your Board Finish and Mill Storage

*Do you want to make lap siding and/or shingles?*

- Lap Siding/Shingle Maker System

*Do you want to protect your investment from the elements?*

- Carriage Covers: Norwood Orange or Green (HD36V2 only)

*Do you want to plane and mould your logs?*

- Log Moulder LX26: Precisely shape and plane beams and oversized boards with maximum efficiency, right on your sawmill.



### DON'T FORGET

**You can add any of these options at any time!**

▶ SEE PAGES 66-82



# BAND BLADES

AND RIPPING CHAINS

**TO GET THE MOST OUT OF YOUR MILL**  
**MAKE SURE YOU CHOOSE YOUR BLADES WISELY**

**A premium-quality blade, with the exact right specifications for your sawmilling application, will increase your production and optimize your cut quality.**

Whether you intend to saw softwoods or hardwoods, green or seasoned wood, frozen logs, or even abrasive reclaimed wood like barn beams, Norwood's wide range of blades will help you find the right fit.

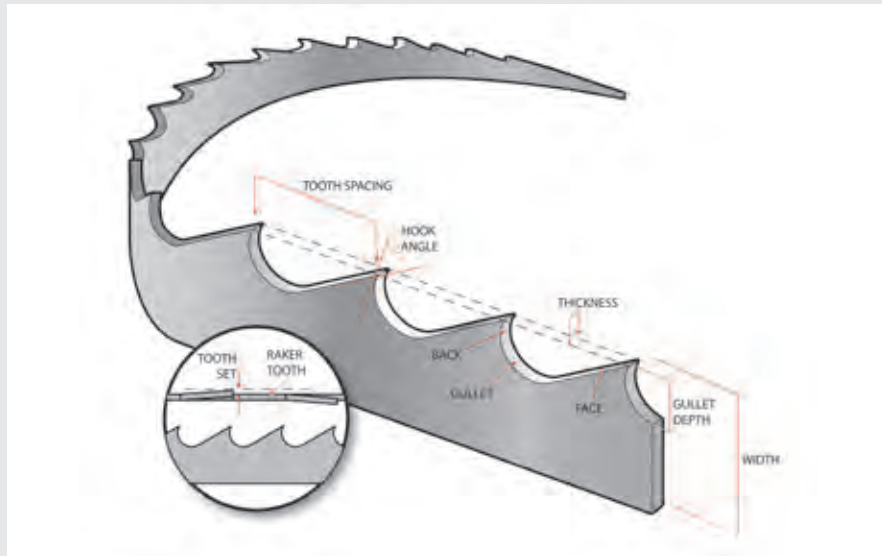

**Knowing band blade basics will help you make the right choice.**

- ▶ **BLADE WIDTH** is the distance from the base of the blade to the tip. The most commonly-used “all-purpose” blade width is 1¼”. Wider blade width (for example, 1½”) is used by some sawyers with higher horsepower sawmills in more difficult cutting conditions such as dry or ultra-hard wood, or to power through softwoods even faster.
- ▶ **BLADE LENGTH** is the overall length of the blade and is governed by the dimensions of your sawmill model.

Length	Norwood Sawmill Models
144”	LM30, MN27, LM29, MN26, ML26, LM2K, LL24, MK34
167”	HD38, HD36V2, LM34

- ▶ **TOOTH SPACING** is the distance from one tooth tip to the next. The term “pitch” is also used in reference to tooth spacing as the number of teeth per inch (“TPI”) on a bandsaw blade. The most commonly-used “all-purpose” tooth spacing is 7/8” (1.1 TPI pitch). Shorter tooth spacing (for example, ¾” (1.3 TPI pitch)) is preferred by some sawyers when milling certain hardwoods or frozen logs.
- ▶ **HOOK ANGLE** is the number of degrees that the tooth face leans forward of vertical. The rule of thumb is the harder the wood, the lower the hook angle. The most commonly used “all-purpose” hook angle is 7° for softwoods and mixed hardwoods. Also popular is 10° hook angle which is more commonly used when cutting mainly soft wood with some mixed hardwoods.
- ▶ **GULLET** is the space between the teeth that captures and carries sawdust out of the cut. It also supports the tooth against the forces applied during cutting. The base of the gullet is the area most adversely impacted by metal fatigue.
- ▶ **GULLET DEPTH** is the distance from the bottom of the gullet to the tip. Norwood’s “DEEP” deep-gullet profile increases the blade’s capacity to remove sawdust from the cut and can, in some applications improve/boost performance when cutting wide boards.
- ▶ **TOOTH SET** is the distance a tooth is offset from the vertical and is normally measured in 1000ths of an inch. The blade’s tooth set affects its cutting efficiency and chip carrying ability. Sawmill blades typically follow a raker three tooth pattern with a uniform set distance left and right, and a third straight “raker” tooth. Choosing the right set balances sawdust and air; a typical set is about 80/20, with 80% sawdust and 20% air being ejected. Too much set results in too much air and not enough sawdust and can leave tooth marks. Too little set restricts airflow and limits the blade’s ability to pull sawdust from the cut; this creates hot, packed sawdust and leads to short cutting times, premature blade breakage and wavy cuts. The sawdust should be warm to the touch, not hot or cold.
- ▶ **BLADE MATERIAL** refers to what the blade is made of and how it is made: Choose from SabreTooth® and Bi-Metal blades.





## SABRETOOTH® BLADES

Norwood SabreTooth bands are a premium-quality flex-back blade with induction-hardened teeth.



Made of the highest quality, correctly-dimensioned, fatigue-resistant, polished spring-steel with precision-ground tooth profile, state-of-the-art induction tooth hardening and tight-tolerance balanced set, SabreTooth blades deliver dependable performance cutting. Throughout the manufacturing process, every blade receives a series of quality inspections to ensure it exceeds industry standards for durability, consistency, blade life, sharpness and performance.



## BI-METAL BLADES

Specialist band blade engineered for high-performance primary wood processing, timber-ripping and resaw applications.

Manufactured with tooth tips made from high-performance M42 high-speed steel hardened to 67 HRC and blade back made of alloy-tempered steel. The Norwood bi-metal blade is a strong, durable and high-performance band that delivers up to 37% greater durability than the competition, significantly faster cutting rates for accelerated productivity, and exceptionally clean, smooth cuts. Its superior resistance to heat and wear increases blade life, prolongs tooth sharpness and reduced production costs.



<b>SabreTooth® Blades</b>						
Blade Width	Length	Tooth Spacing	Hook Angle	Deep Gullet	Qty / Pack	Item No.
1 ¼"	144"	7/8"	7°	-	10	BLDS-ST114X144-78-07
1 ¼"	144"	7/8"	7°	-	5	BLDS-ST114X144-78-07-B
1 ¼"	144"	7/8"	10°	-	10	BLDS-ST114X144-78-10
1 ¼"	144"	7/8"	10°	-	5	BLDS-ST114X144-78-10-B
1 ¼"	144"	3/4"	10°	-	5	BLDS-ST114X144-34-10-B
1 ¼"	167"	7/8"	7°	-	10	BLDS-ST114X167-78-07
1 ¼"	167"	7/8"	7°	-	5	BLDS-ST114X167-78-07-B
1 ¼"	167"	7/8"	10°	-	10	BLDS-ST114X167-78-10
1 ¼"	167"	7/8"	10°	-	5	BLDS-ST114X167-78-10-B
1 ¼"	167"	3/4"	10°	-	5	BLDS-ST114X167-34-10-B
1 ½"	167"	7/8"	10°	Yes	10	BLDS-DF112X167-78-07DEEP-10
<b>Bi-Metal Blades</b>						
1 ¼"	167"	7/8"	10°	-	1	BLDS-CB138
1 ¼"	144"	7/8"	10°	-	1	41475



Just as important as choosing the right blade, getting peak performance out of your sawmill depends on looking after them right.

Check out Norwood's Blade Maintenance equipment. [▶ SEE PAGE 101](#)



## SABRECHAIN® RIPPING CHAINS

Chainsaws are normally used to fell trees, and the normal chainsaw chain we are all familiar with is specifically meant for that cross-cutting application. But sawing boards, lengthwise down the grain, as versus cutting across the grain for felling, involves different considerations.



Ripping chain is 3/8" pitch and features a special factory grind for making dimensional boards and planks from timber by "ripping" it (cutting parallel to the wood grain). Equipping your chainsaw with a proper ripping chain improves both performance and yield when you saw boards with your chainsaw and Norwood's PortaMill PM14 chainsaw sawmill.

- ▶ .050" x 20" x 72 links (fits SabreBar)  
(Item No. PM14-RC05X20)
- ▶ .050" x 18" x 66 links (Item No. PM14-RC05X18)
- ▶ .050" x 24" x 84 links (Item No. PM14-RC05X24)
- ▶ .058" x 18" x 68 links (Item No. PM14-RC58X18)
- ▶ .058" x 20" x 72 links (Item No. PM14-RC58X20)
- ▶ .058" x 24" x 84 links (Item No. PM14-RC58X24)



## SABREBAR® CHAINSAW BAR

Premium-quality solid chainsaw bars specifically engineered to deliver superior performance milling (ripping) boards and lumber: smoother and straighter cuts, reduced milling marks and increased bar life.



SabreBar features precision-squared and flame-hardened rails made of cold-rolled, annealed, surface-ground and stress-relieved steel with precision-ground groove to within .002".

- ▶ C1-20-50-.375" (Item No. PM14-C120503)
- ▶ S1-20-50-.375" (Item No. PM14-S120503)
- ▶ Adapter plate (S1 (12.10 mm) to H1 (9.00 mm))  
(Item No. PM14-S1H1)

**IMPORTANT:** Regular and precise blade, chain and bar maintenance is critical to maximizing performance, productivity and prolonging the life of your parts and your equipment. Sorry, there is no warranty on consumable items such as blades, chains or bars.





# BLADE MAINTENANCE

SHARPENERS AND SETTERS

**YOUR BANDS NEED REGULAR TUNE-UPS  
TO MAKE SMOOTH CUTS AND  
PROLONG THE LIFE OF YOUR BLADES**

The easiest, and most cost effective way to maintain your blades is to invest in your own blade-optimization equipment—precisely-engineered sharpening and setting machines.

# NORWOOD STANDARD SHARPENER

## ITEM NO. 41180

Quality lumber and blade life depend on a sharp blade. The full blade profile should be sharpened at least every couple of hours.

Most sharpeners and re-sharpening services only treat the tooth face. This leaves the blade vulnerable to premature blade breakage because it completely misses microscopic stress cracks that form at the root of the tooth and in the gullet.

The Norwood Sharpener maintains the full tooth profile including the gullet. This unique action allows the stone to gently remove those microscopic stress cracks that, if left unchecked, lead to premature blade failure.

Semi-automatic, simply turn the crank and the Norwood Sharpener will do the rest, simultaneously advancing and profiling the entire blade in only about eight minutes.

The Norwood Standard Sharpener is factory-configured to profile Norwood SabreTooth  $\frac{7}{8}$ "-pitch blades. Optional cams are available for other  $\frac{3}{4}$ ",  $\frac{7}{8}$ ", and 1" pitch blades\*. Every Norwood Standard Sharpener comes complete with a 110-volt high-speed rotary-tool, and a six Norwood MTW ceramic-compound stones which need no dressing or truing before use.

*\* Speak with a Norwood customer service representative to confirm which blades the optional cams will profile.*

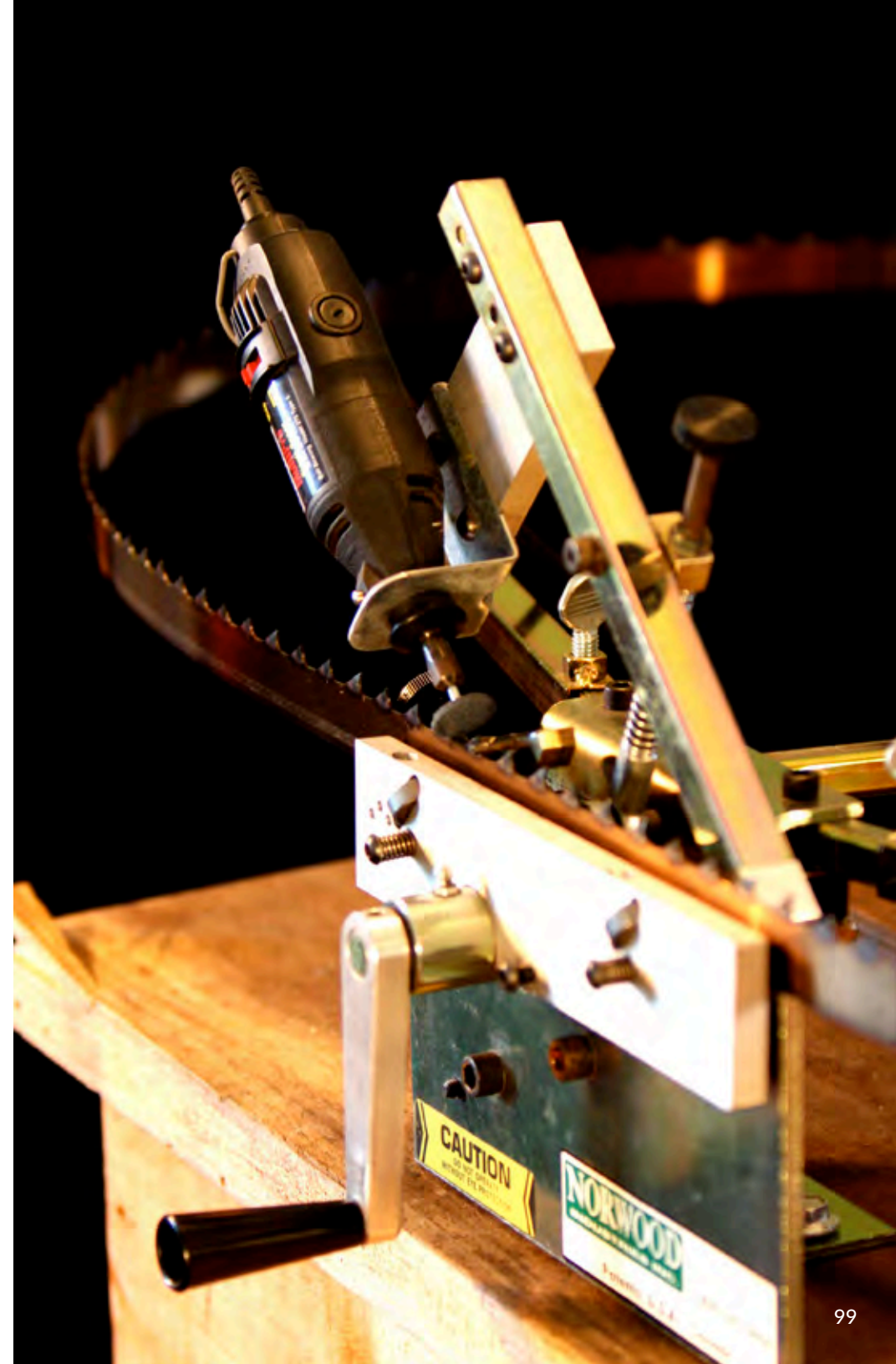



## NORWOOD BLADEMATE® PRO SHARPENER

### ITEM NO. 41182

Designed for continuous heavy use, the Norwood BladeMate Pro sharpener is built for custom-sawyers and anyone who mills regularly.

The BladeMate Pro sharpens the entire tooth profile: face, gullet and back. Equipped with an integrated 12 V motor, sharpen your blades anywhere, even at your milling site. Manually-operated, the semi-automatic action means you simply turn the crank, and the grinder does the rest, precisely advancing and profiling each tooth.

Calibrated specifically to exactly profile SabreTooth 7/8"-pitch blades at 10° hook angle. Accommodates both 1 ¼" and 1 ½"-width blades. Precision-machine and calibrated components, and preloaded precision-bearings, minimize vibration throughout grind cycles. Sealed, dust-resistant cabinets, and industrial plating & power-coating, protect and extend component life.

Equipped standard with a premium 120 mm x 4 mm vitreous aluminum-oxide grinding wheel, and sturdy tripod support legs, Norwood's BladeMate Pro sharpener comes complete with everything you need to get started.

## NORWOOD TOOTH SETTER

### ITEM NO. 41190

Teeth naturally lose their set over time which reduces blade efficiency. It can also cause the blade to dive/climb, or produce wavy or scored boards. Check and restore tooth set at least every 3 sharpening for efficient, straight, and smooth milling.

### Set your blades to mill perfect lumber with Norwood's Tooth Setter.

Plunger-style design to accurately and systematically check the set of each tooth before engaging the mechanism to restore the set. Reset an entire blade in less than 15 minutes.

The Norwood Standard Tooth Setter is factory-configured to set 1 ¼" blades. Optional retrofit kit is available for 1 ½" blades. Precision CNC-machined and zinc-dichromate plated. Comes equipped with a dial indicator and support arms.



*I have cut thousands of board feet with my Norwood. Not one problem in 15 years. A name you can put your money on."*

Richard Swiger ★★★★★

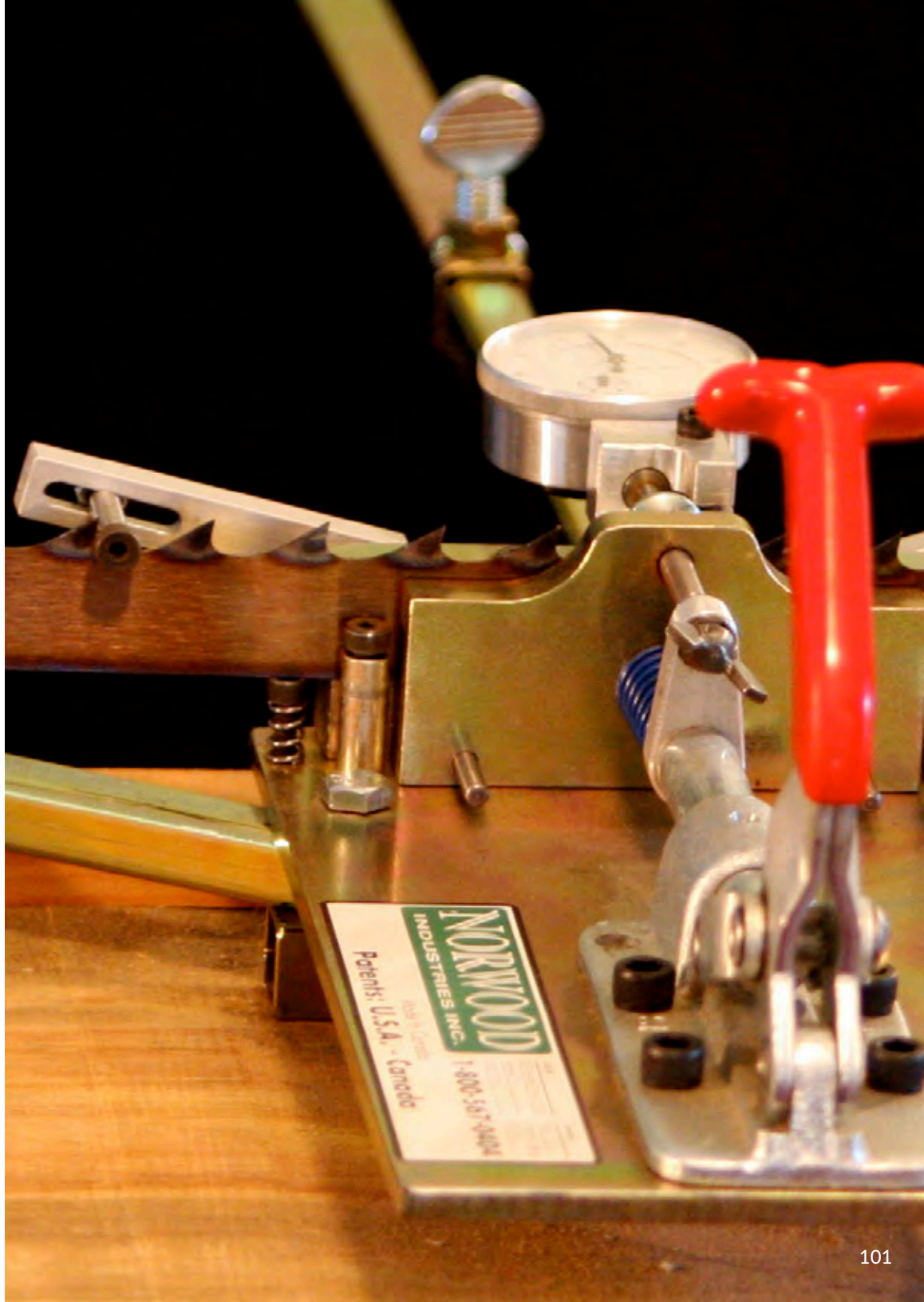



# LOG HARVESTING

## SKIDDING & FELLING EQUIPMENT



**LOGGING IS A WAY OF LIFE**

**A CALLING PASSED THROUGH GENERATIONS**

That's why we're dedicated to providing log harvesting and skidding equipment specifically for the work that you do.  
It's our way of making one of the toughest jobs in the world just a little bit easier.



# SKID-WINCH – HYDRAULIC LOG SKIDDING FOR TRACTORS

## ITEM NO. 41250-HD-SW

The Norwood Skid-Winch goes where you want, so you can winch logs from deep in the forest right to the trail, ready for choking and hang-up-free skidding out.

- ▶ **Hydraulic Winch Motor** – powered by your tractor’s rear hydraulic outputs, the large heavy-duty hydraulic winch motor generates loads of constant pulling power.
- ▶ **Patented Capstan Winch** – the heart of the Skid-Winch is the patented capstan winch. A few wraps of the high-tensile-strength rope around the constant-speed capstan give you full control over the winching operation with simple application of tension on the “tail-end” of the rope—Engage the Skid-Winch’s powerful pulling power by tensioning the rope. Release to instantly disengage.
- ▶ **Built-In Receivers** – securely store chainsaw, cant hook and choker chains for quick, convenient access.
- ▶ **Multi-Function Stabilizer Legs** – dig firmly into the ground during winching operations. Reconfigured, they transform into forks that lift and move logs and boards.
- ▶ **Standard-Equipped Hitch Receiver** – for convenient towing operations while the Skid-Winch is attached to the tractor.

*Load varies depending on terrain and tractor size and type. Operation on hilly terrain or in wet conditions not recommended. Front-mounted counterweights recommended. Good judgment and experience required. Choker chains, trailer hitch, log hook, cant hook and chainsaw sold separately.*



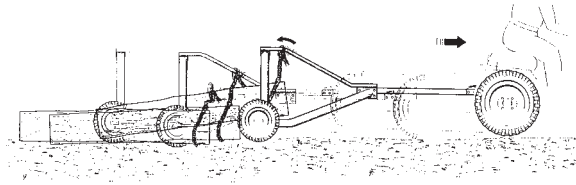

## SKIDMATE® MK2 – LOG SKIDDING ARCH FOR ATVS

### ITEM NO. 41250-MK2

Pull logs out of your woodlot and right to your milling site, by yourself with your ATV, using the Norwood SkidMate MK2.

- ▶ **Nimble and narrow enough to reach deep into the forest,**
- ▶ **Rugged enough to handle uneven terrain,**
- ▶ **Light enough to help keep your woodlot floor healthy and productive.**

The **self-loading design** means that, as you gun the ATV, the choked end of the log, connected to the smooth-action roller, slides up the bar and is hoisted high into the arch. This keeps your logs off the ground, mud-free and easier to skid. To unload, simply reverse the ATV. The position and angle of the wheels help ensure that the SkidMate MK2 can ride up and over small rocks and logs.

Beware of Chinese-made imitations of Norwood's original log arch design. Norwood's SkidMate MK2 is made of North-American steel,

protected by commercial-grade powder coating and manufactured here to meet Norwood's high standards.

The SkidMate MK2 can handle logs up 18" (45 cm) wide by 12 ft (3.6 m) long and 760 lbs (350 kg). Maximum load of 350 lb (160 kg) at the arch\*. Shipped in kit form to keep your delivery costs to a minimum. (Choker chain and grapples sold separately.)

*\*Actual load varies depending upon terrain and ATV size and type. Operation on hilly terrain or in wet conditions not recommended. Good judgment and experience required.*

### SKIDMATE MK2 TECHNICAL DATA OVERVIEW

Width	65" (165 cm)	Arch Construction	2½" (6.25 cm) round powder-coated tubular steel	Coupler Size	2" (5 cm)
Height	41½" (105 cm)			Wheels	16x6.5-8 turf tire
Total Length	7.4' (2.2 m)			Maximum Log Length*	12' (3.6 m)
Total Weight	92 lb (42 kg)			Maximum Log Weight*	760 lb (350 kg)

# LOGHOG™ — LOG SKIDDING FOR TRACTORS

## ITEM NO. M-LH

Skid single or multiple logs easily out of your woodlot with your tractor and the Norwood LogHog.\*\*

Like the big commercial log skidders, the LogHog lifts the end of the log off the ground and secures it close to the tractor. This keeps your logs cleaner for more efficient milling, reduces hang-ups and damage to your woodlot floor and increases maneuverability through winding forest roads.

The LogHog is quality-built in North America of heavy-gauge square tubular steel and protected with commercial-grade powder-coating for superior rust resistance. With no mechanical components to breakdown, no maintenance is required—ever!

The LogHog is designed to fit Category 1 three-point tractor hitches. Some assembly required. (Choker chain and grapples sold separately.)

*\*\*Actual load varies depending upon terrain and tractor size and type. Operation on hilly terrain or in wet conditions not recommended. Front-mounted counterweights recommended. Good judgment and experience required.*



*The SkidMate works absolutely great and is more maneuverable than expected.”*

Ross Allen & Phillip Grant, NS ★★★★★





## GRAPPLES: 14 & 20 SERIES

Grapples are ideal to grab single logs, fast. The scissor-action jaws of Norwood's Grapples 14 and 20 bite hard and hold fast—the more you pull, the tighter the teeth dig into the log.

Their twin grapple arms, separated by machined and zinc-dichromate-plated spacers and dual teeth laser-cut for maximum sharpness, deliver superior clamping stability.

Protected by Norwood's industrial-grade powder-coating and comes in kit-form to cut your shipping costs to a minimum.

Norwood's Grapple 14 accepts logs up to 14" (35 cm) in diameter, while the larger Grapple 20 can handle logs up to 20" (50 cm) wide. The Grapples 14 and 20 are ideal not just for skidding logs, but for use when lifting logs with a loader.

- ▶ Grapple 14" (Item No. 41380)
- ▶ Grapple 20" (Item No. 41382)



## MINI-GRAPPLE

### ITEM NO. 41380-MINI

For skidding small logs up to 14" (35 cm), the Mini-Grapple is an economical solution. Much narrower than the wide-jawed Grapples 14 or 20, and with only three grapple plates, it is lighter to carry and operate. Features the same sharp laser-cut teeth as the larger Grapple 14.



## CHOKER CHAIN WITH PROBE

### ITEM NO. 41280

Choke single and multiple logs quickly and professionally using Norwood's 7 ft (2.1 m) choker chain with steel probe.

The choker chain is the only solution to choke larger logs up to 22" (55 cm), or multiple logs, and lifts the log higher in the SkidMate arch than a grapple.

The chain is rated 70-grade and has a working load limit of 4700 lb (2136 kg).

# TIMBERTOOL™ TREE-FELLING JACK

**ITEM NO. 41260**

Fell trees faster, safer and more accurately with the Norwood TimberTool Tree-Felling Jack.

Like a high-lift jack, the TimberTool cranks up to 1.8 tons/inch pressure against the tree. This power helps:

- ▶ Push the tree in the fall-line you've chosen.
- ▶ Force the felling cut open so the tree can't settle and bind your chainsaw bar.
- ▶ Reduce the need for time-consuming wedging and cabling.

Ruggedly built of high-grade, close-tolerance steel, the TimberTool is also equipped with sharp teeth to bite strong in the tree and a hooked base to dig firmly into the ground.

The TimberTool is a must for anyone who wants to fell trees more safely, precisely and professionally.

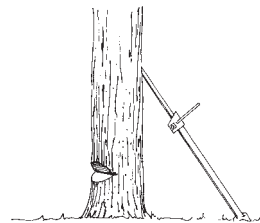
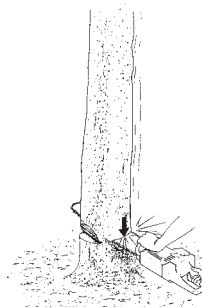

**NOTCH CUT**

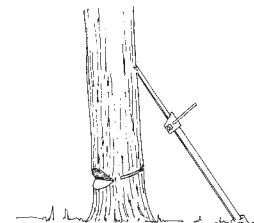

**FELLING CUT**

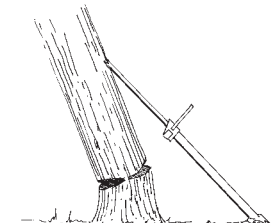

**CRANK & PUSH**

## TIMBERTOOL TECHNICAL DATA OVERVIEW

<b>Length</b>	4'4" (1.3 m)	<b>Weight</b>	36 lb (16 kg)
<b>Length Extended</b>	8'1" (2.43 m)	<b>Ratio/Lift Capacity</b>	27/4 950 lb (2 200 kg)

*Actual load and limitations vary depending on terrain, tree height, weight, size and angle of lean. Good judgment and experience required.*



# LOG HANDLING TOOLS

Log handling tools are an absolute must to move, lift, leverage and roll logs around the sawing site and on your mill.

Norwood's cant hook, peavey and log-carrier feature strong yet lightweight aluminum handles and heat-treated, zinc-plated hooks that **grab hard**. Painted Norwood Orange for high visibility around the woodlot. These are modern, premium-quality versions of the tried, tested and true traditional tools used by generations of loggers.



## PEAVEY (42")

**ITEM NO. PV042**

Indispensable for rolling logs around the woodlot and onto the mill. Jab the peavey point into the ground to gain extra torque for log rolling. The 42" (105 cm) handle gives good leverage without being cumbersome. Grips 8"-32" (20 cm-80 cm) diameter logs.

## LIFT HOOK

**ITEM NO. 41310**

Saves lifting logs by hand. Especially helpful in wet weather.

## PEAVEY (48")

**ITEM NO. FRON-PV048-W**

With wood handle.



## CANT HOOK (30")

**ITEM NO. MS030**

Designed to turn and roll logs while on the mill. At only 30" (75 cm) long, this cant hook is nimble and easy to handle. Grips 8"-32" (20 cm-80 cm) diameter logs.

## LOG CARRIER (54")

**ITEM NO. LC054**

Sturdy two-man timber carrying tool for moving logs around the milling site. Textured rubber grips for easy, no-slip holding. Handle is 54" (135 cm) long.



## LOG WIZARD – CHAINSAW ATTACHMENT

**ITEM NO. 41240**

**Debark and notch logs with the Log Wizard.**

Equipped with two standard 3 1/4" planer blades, the Log Wizard makes quick work of debarking dirty logs at the point entry of your band blade's first cut—prolongs the life of your saw blades.

Fits all chainsaws and universal 7 tooth spline adapts to both 3/8" and .325 chain.



## THE ULTIMATE GUIDE TO PORTABLE SAWMILLS

**ITEM NO. 978-0-9961369-0-7**

In this 140-page book, you'll discover...

- ▶ **Your biggest sawmilling questions answered!**
- ▶ **Game-changing secrets for sawmilling success**
- ▶ **Milling for money**
- ▶ **7 essentials for choosing the right sawmill**
- ▶ **Cutting—Drying—Grading**
- ▶ **Plus plans—build your world!**

Get the Ultimate Guide *free*—just pay shipping.



*I've read the "Ultimate Guide" book about three times already and find something new each time... Awesome book. Very detailed. Love the chapter on sawing pattern potential and the tips and tricks."*

Billy Reeder ★★★★★



## MANAGING FOR PROFIT: SUCCESSFUL SAWMILL MANAGEMENT

**ITEM NO. BOOK-MGMTE**

This 208-page book is divided into five parts dealing with marketing and salesmanship, financial management, operations management, personnel management, and other key issues and tools for managers. A variety of essential topics—such as exporting, budgeting, downtime management, recruiting, and effective decision-making ensure that this book is **a must for the sawmill manager who wants to succeed.**



## SAWMILL SPARE PARTS KITS

Built rugged, Norwood mills run pretty much trouble-free.

Even so, it's always a good idea to keep a couple spare parts on hand to ensure your milling operation stays on schedule.



## QUICK-DRAIN OIL VALVE

Make your oil changes clean and simple with a quick-drain oil valve and tube kit.

The engine is bolted on top of the sawhead. But the oil drain plug is at the bottom of the engine, making oil changes messy as oil pours out over your sawhead. Install a quick-drain on your engine during assembly to make oil changes easy.

Each kit includes a drain-valve and flexible tube.

- ▶ Oil-Drain Kit for Briggs 16 hp, 18 hp & 23 hp (Item No. ENGA-DRN-BRIGGS)
- ▶ Oil-Drain Kit for Briggs 10 hp & 13½ hp; Kohler 14 hp; Honda 9 hp & 13 hp (Item No. ENGA-DRN-HONDA)

## ENGINE MAINTENANCE PACKAGES

Your sawmill engine takes a beating. Because it runs in harsh conditions, it's important to service it regularly so your mill runs at peak performance.

That means changing the oil, filters and plugs at least yearly, and more often if you mill a lot. Conveniently order all the parts you need in one easy step.



Engine Kit	Air Filter	Pre-Cleaner	Fuel Filter	Oil Filter	Spark Plug	Item No.
Briggs & Stratton 13½ hp	✓	✓			1	ENGP-KIT13BS
Briggs & Stratton 16 & 23 hp (auxiliary fuel tank)	✓	✓	✓	✓	2	ENGP-KIT23BS
Briggs & Stratton 16, 18 & 23 hp (integrated fuel tank)	✓	✓	✓	✓	2	ENGP-KIT1623BS-INTG
Kohler 14 hp	✓	✓	✓		1	ENGP-KIT14KO
Honda 9 & 13 hp	✓	✓			1	ENGP-KIT913HON
Honda 20 hp	✓	✓	✓	✓	2	ENGP-KIT20HON

▶ TIP: Ask us about the deluxe spare parts kit for your sawmill which includes a broader list of parts. If you plan on milling commercially, or your sawmill operation is outside of North America, consider a more comprehensive stock of extra parts.



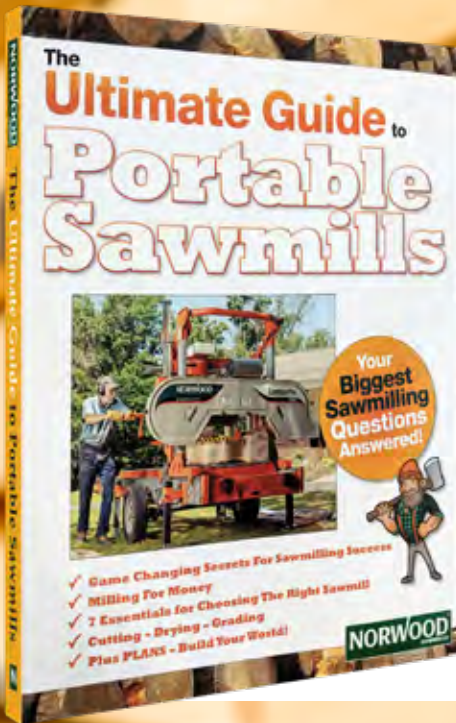

## WANT TO LEARN MORE?

Ask for your FREE copy of  
*“The Ultimate Guide to Portable Sawmills”*

You'll find chapters that cover:

- ▶ What you need to know to prepare for your first log
- ▶ Drying your wood
- ▶ Sawing patterns demystified (including quarter sawing)
- ▶ An introduction to lumber grading
- ▶ How you can turn your portable sawmill into a profitable business...

Plus loads of other great pro-sawmilling tips.

## READY TO SEE MORE?

Check out SAWMILL.TV®, the world's only on-line “TV” channel devoted exclusively to sawmills and successful sawmilling.

**Whether you're an expert or new to sawmills, Sawmill.TV has something for you:**

- ▶ “Norwood Sawmills in Action”—See them all in action
- ▶ “Sawmill School”—Learn sawing basics
- ▶ “Successful Sawmilling”—Learn advanced sawing techniques
- ▶ “Sawmill Tech Tips”—Tips and tricks to optimize your mill
- ▶ “Sawmill Savvy Minutes”—Bite-sized nuggets of wisdom from the pros...

And so much MORE Sawmill savvy!

It's your one-stop-channel for everything you need to know—From opening your first log... to making “WOW” cuts that will amaze your friends.





**CONFIDENCE:**  
**NORWOOD GIVES YOU  
THE WORLD'S MOST  
COMPREHENSIVE SAWMILL  
LEARNING TOOLS AND  
SUPPORT.**

Bringing home a legendary Norwood means more than owning one of the world's most innovative sawmills.

When you invest in a Norwood, you become a member of the Norwood family.

Norwood stands behind you with the best learning tools, lifetime support, and a community of fellow Norwood owners.

Watch videos to learn new techniques. Ask our team of experts for ways to optimize your mill. Or learn from our amazing community of owners.

Whether you're new to sawing, or have years of experience, you'll find the resources you need to build your best future through wood.



**FREE LIFETIME  
SUPPORT.**

From set-up, to sawing,  
to maintenance...

We're just a toll-free  
phone call away,  
*every step of the way.*

**JOIN OUR ON-LINE FORUM,**  
**[NorwoodSawmills.com/forum](https://www.norwoodsawmills.com/forum)**



Established in 2002, "Norwood Connect" is one of the very first forums dedicated to portable sawmills, forest management & wood-processing. It has become the essential "Go-To" place for thousands of sawmilling enthusiasts around the world. Join and connect with fellow sawyers to discuss milling, exchange ideas and know-how, and share stories.

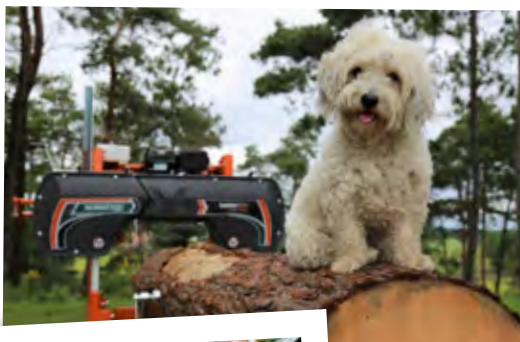

Worth every penny. Anytime I had a question during the assembly process I could call into Norwood and talk to someone that actually owns the same mill and regularly has hands on it so is a thousand percent more familiar with their product than the average company technical support."

Steven LeNoir ★★★★★

If you're in the market for a bandsaw mill, do yourself a favor and buy a Norwood. The equipment speaks for itself. The product and customer support is just icing on the cake."

Jeremiah Wright, AR ★★★★★

Look, if you have doubts about this thing, I'm a woodworker in a high-end cabinet shop and we are all craftsmen. A co-worker got one last year and is killing it with his. He's been with us 8 years and is leaving soon to go full time with it. I have personally helped and it's just a great product."

Shane Osborne, NC ★★★★★

You don't have to be a serious woodworker. Just someone that loves to create. The sky is the limit. Thank you Norwood Sawmills. The greatest investment we have made."

Holly Mae Mosser, BC ★★★★★

My Norwood sawmill has become one of my most useful tools on my 60-acre Missouri Ozark farm. Without question I have recovered the initial cost of purchase of the sawmill. Along with the economic benefit, the pride of cutting and building from lumber harvested on my own land is unmeasurable. I get a kind of frontier/homestead feeling. I am constantly looking for a reason to fire up my sawmill! I wish I would have bought it years ago when I first started developing my homestead."

Daniel Adams, MO ★★★★★

My husband and I have one and it's awesome. We've had it almost 6 years and the only thing we have to buy is blades. It has paid for itself 10 times over and we sell beautiful wood that we mill. Get yourself one. You'll love it!"

Stephanie Shoaf Blackstock ★★★★★



1-800-567-0404

Call TOLL-FREE from U.S.A. or Canada Monday to Friday, 8:30AM-4:30PM EST

Visit us or shop on-line at: **NorwoodSawmills.com**

E-mail: [info@norwoodsawmills.com](mailto:info@norwoodsawmills.com)

### U.S.A. Factory Warehouse

Norwood Sawmills U.S.A. Inc.  
730 Young Street, Unit 900  
Tonawanda NY 14150

### CANADA Factory Warehouse

Norwood Industries Inc.  
2267 15/16 Side Road East  
Oro-Medonte ON L0L 1T0



**Not in the U.S.A. or Canada?** Norwood services over 100 countries worldwide either factory-direct or through Norwood's network of authorized international dealers.

Contact us to learn more: +1-705-325-0030 or [info@norwoodsawmills.com](mailto:info@norwoodsawmills.com)

## WARRANTY

We're so convinced of the quality and durability of our band sawmills, that we will repair or replace, at our discretion, any part returned to us and found to be defective through manufacturing within the first two years of the original purchaser's ownership, with the exception of consumable items such as belts, blades, bearings, etc... Norwood offers a one-year limited warranty on the PortaMill, Log Moulder, hydraulics and most other equipment. Engines are covered by a 2-year warranty directly with the engine manufacturer. Ask for full details.

## GUARANTEE

We know that you will be 100% satisfied with the value and performance of your Norwood equipment. We back that up with a 30-day money-back guarantee. If your Norwood equipment doesn't do everything we say, simply return it to us within 30 days after which we'll send you a refund (less the value of used blades and missing or damaged parts; shipping not included).

## SHIPPING & DELIVERY OPTIONS

Because of our high volumes and negotiated discounts with a select group of freight companies, we can offer you the lowest possible shipping charges. Orders are shipped prepaid, which means that the shipping charges are paid at the time of your order.

In the U.S.A. and Canada, Norwood band sawmills and oversize orders ship by common-carrier freight truck directly to your residence or business so it is important that your delivery address is easily accessible to a tractor-trailer. Shipped in knock-down form, we package oversize orders on a 4' x 4' (1.2 m x 1.2 m) and 4' x 6' (1.2 m x 1.8 m) pallets and we band and stretch-wrap your order for secure shipping.

Most trucking companies require the driver to bring the shipment to the back of the truck. Because your sawmill order is shipped in knock-down form and consists of individual pieces and boxes each weighing up to 100 lb, you can offload your order box by box and do not necessarily

need special forklift equipment. If you cannot manage weights up to 100 lb, you may want a helper to assist you to unload your order.

You or your designated agent must be present to accept the order and off-load it. If no one is at the delivery address to accept the order, redelivery and storage charges may apply. After your order has shipped, you may want to call the trucking company to confirm date of delivery; call us to obtain your carrier name and phone number, shipment tracking number and ship date.

If you would like to pick up your sawmill order direct from one of Norwood's factory warehouses, call us toll-free at 1-800-567-0404 at least three (3) business days in advance so that we can have your order ready. You will need a pick-up truck, full-size van or enclosed trailer to pick up your sawmill or oversized order.

**IMPORTANT:** To ensure that you receive the best possible value, Norwood ships all equipment in knock-down form with step-by-step assembly instructions and detailed illustrations, exploded views and photos.

**IMPORTANT:** In all cases, before signing for any shipment (by signing the freight waybill or packing slip), check your order carefully upon delivery to ensure that you receive all pieces and boxes listed on your packing slip and that they are in good order. All claims not reported in writing on the freight waybill at the time of delivery become the sole responsibility of the purchaser; failure to report missing or damaged pieces & boxes in writing on the freight waybill at the time of delivery nullifies your insurance and precludes any subsequent claims.

## PAYMENT OPTIONS

We accept bank transfers, bank (cashier's) checks, Visa, MasterCard and PayPal. All but the bank transfers undergo security verifications. Please note that if payment is received by credit card, Norwood can only ship to the same cardholder's address that the issuing bank has on file; furthermore, if picking-up, you must PIN your card. If payment is received by PayPal, Norwood must ship the order to the purchaser's secure verified PayPal address; furthermore, pick-up is not feasible. All orders are to be prepaid in full prior to shipping. Financing options are also available, please contact us for more information.

© 2021 Norwood Industries Inc. All rights reserved. The color orange as it relates to sawmills, edgers, skidders & related equipment, the "chevron" graphic, the LumberJack® mascot, and the trade-names Norwood®, LumberMax®, LumberPro®, LumberMate®, LumberMan®, LumberLite®, LM Pro®, PortaMill®, SkidMate®, BladeMate®, SabreTooth®, SabreBar®, SabreChain®, HD38®, HD36®, LM30®, MN27®, LM29®, MN26®, Trekker®, Duradeck®, Sawyer-Assist®, Sawmill TV®, Omega®, Intellis®t®, Frontier®, OS®, OS23®, OS27®, OS31®, "Forest. Fun. Freedom." & MultiMate® are registered trademarks owned by Norwood Industries Inc. in multiple jurisdictions. Functional and design elements of Norwood sawmills and log handling equipment are protected by registered patents and pending patents in multiple jurisdictions.

Disclaimer: Specifications, designs, descriptions, illustrative material and prices in this and all Norwood print and on-line media are as accurate as known at the time of publication, but are subject to change without notice. Illustrations may include optional equipment and accessories and may not include all standard equipment. This literature has been compiled for worldwide circulation; while general information, pictures and descriptions are provided, some illustrations and text may include product features, options and accessories not available in all regions.

**MAKE YOUR MARK  
LEAVE YOUR LEGACY**





45,000 Norwood Sawmills are  
hard at work in 100 countries  
worldwide.

**A NORWOOD WILL WORK FOR YOU.**  
Find out how.

**Call Toll-Free Today**  
**1-800-567-0404**



**NorwoodSawmills.com**