

User Manual

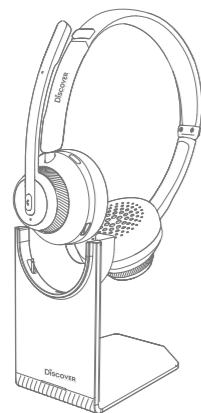

Discover Wireless UC Headset

Discover Boomstick Wireless Duo

Thank you for purchasing DISCOVER Wireless headset.

1.Product Overview

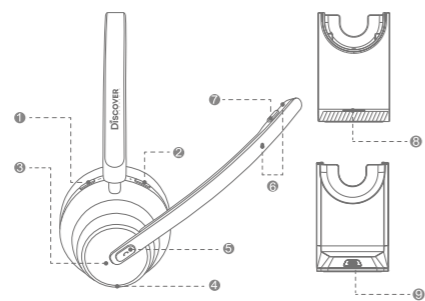

- 1 Volume - Button
- 2 Volume + Button
- 3 LED Indicator
- 4 USB-C Port
- 5 Power/Bluetooth Button
- 6 Microphone Boom
- 7 Mute and Sidetone on/off
- 8 Charging indicator
- 9 USB-C Charging port

2.What's Included?

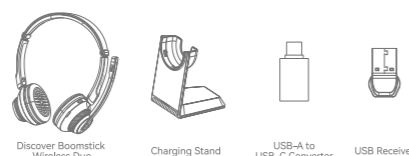

EN-1

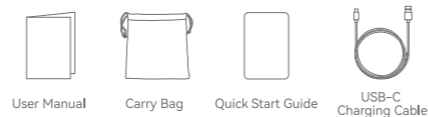

3.Charging

- Fully dry off the USB-C charging port or the converter before charging.
- Use the USB-C charging cable certified and charger or computer to charge.
- Fully charge the headset before the first use.

Charging by the Headset's USB-C port

- Connect the headset to the power supply via the USB-C charging cable.
- Choose the power supply by a charger or computer's USB output port, which is compatible with all your USB A or C charger by providing a USB-A to USB-C Converter.
- The LED indicator of the power/Bluetooth Button will turn from green to steady red when charging, and it will turn off when the headset is fully charged.

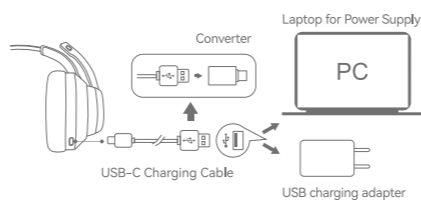

EN-2

Using the Charging Stand

1. Connect the charging stand to the power supply via the USB-C charging cable.
 - The LED indicator on the charging stand will turn steady red when powered.
2. Align the charging pins on both the headset and the charging stand for successful charging.
 - The LED indicator on the headset will turn red for charging, and turn steady green on the charging stand, and the headset indicator will turn off when it is fully charged.
 - Only available for the version with this charging stand.

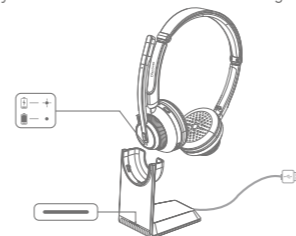

4.Battery Status

When the battery power is below 5%, the LED indicator on the headset will flash red twice and prompt "Battery low" voice every 3 minutes.

5.Wearing

- Wear the headset with the microphone boom on either side.
 - Adjust the microphone boom close to your mouth.
- Tips:**
When switching from one side to the other, the microphone boom must be lowered all the way down and directed towards your mouth so that the volume adjustment direction and sound channels can be adjusted accordingly.

EN-3

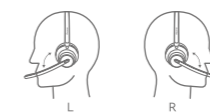

6.Power On/Off

Press and hold the power button for 2 seconds to power on and 4 seconds to power off.

- The LED indicator on the headset will turn green for 1 second when powered on, and turn red for 1 second when powered off.

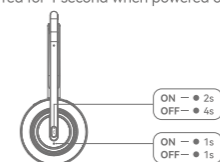

7.Pairing Bluetooth Pairing

Press and hold the power button for 4 seconds to enter Bluetooth pairing mode when in off status.

- The LED indicator on the headset will flash green and red during pairing status.
- Select "Boomstick Wireless Duo" on your device's Bluetooth list to connect.
- When successfully connected, the LED indicator on the headset will turn green steadily.



EN-4

For more information, please visit our official website www.discoverheadsets.com

Your valuable comments and suggestions on improving DISCOVER products are welcome!

info@discoverheadsets.com
www.discoverheadsets.com

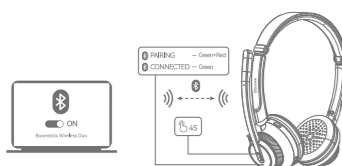

Pairing with Two Devices

To pair with another device when already connected with one device.

- 1) First you need to power off the first device's Bluetooth and the headset will turn to repairing mode.
- 2) Next you can connect to another device quickly.
- 3) Finally power on the first device's Bluetooth and manually connect the headset.

Tips:

1. After that, it can automatically connect the last two devices when you power on it.
2. If you want to switch off the "Two devices" mode during disconnected status, you can triple click the power/Bluetooth button, you will hear one "du".
3. If you want to switch on the "Two devices" mode during disconnected status, you can triple click the power/Bluetooth button, you will hear two "du". (Two devices can be connected default)

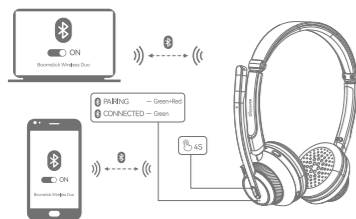

EN-5

Pairing with USB Bluetooth Receiver

Plug the USB Bluetooth receiver (with the USB-A to USB-C Converter, if necessary) into your PC's USB port. Discover Boomstick Wireless Duo will automatically connect to your PC when powered on.

- The LED indicator on the USB Bluetooth receiver will flash green during pairing, and will be steady green when connected.
- Make sure to select "Boomstick Wireless Duo" as the audio input and output device for your conferencing software and computer.

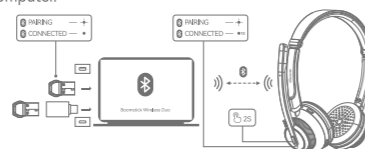

8. Specification

Input	5V=0.5A
Charging time	1h 30min
Playtime	48 hours
Call Time	32 hours
Battery capacity	400mAh
Driver size	30 mm
Microphones	Microphone boom with 2mics
Impedance	32 Ω
Frequency response	20 Hz - 20 kHz
Headset Bluetooth version	V 5.1
USB receiver Bluetooth version	V5.0
Bluetooth range	10 m / 33 ft
Sidetone	2dB

Tips: Specifications are subject to change without notice.

EN-6

9. Controls

Buttons	Functions	Operations
Power/Bluetooth	Power on	Press and hold for 2 seconds when powered off
	Power off	Press and hold for 4 seconds when powered on
	Play/Pause	Press once
	Answer/End a call	Press once when calls coming
	Reject a call	Press and hold for 2 seconds when calls coming
	Last number recall	Press twice
Volume+/-	Volume up	Press once by volume+
	Volume down	Press once by volume-
	Next track	Press and hold volume+ for 2 seconds
	Previous track	Press and hold volume- for 2 seconds
Mute	Mute microphone	Press once
	Mute off	Press once
	Sidetone on	Press and hold for 2 seconds
	Sidetone off	Press and hold for 2 seconds

EN-7



CAUTION
RISK OF EXPLOSION IF BATTERY IS REPLACED BY AN INCORRECT TYPE
DISPOSE OF USED BATTERIES ACCORDING TO THE INSTRUCTIONS

RECYCLING

This product bears the selective sorting symbol for Waste electrical and electronic equipment (WEEE). This means that this product must be handled pursuant to European directive 2012/19/EU in order to be recycled or dismantled to minimize its impact on the environment. User has the choice to give his product to a competent recycling organization or to the retailer when he buys a new electrical or electronic equipment.



--- DC voltage

EN-8

This device complies with part 15 of the FCC Rules. Operation is subject to the following two conditions: (1) This device may not cause harmful interference, and (2) this device must accept any interference received, including interference that may cause undesired operation.

Any Changes or modifications not expressly approved by the party responsible for compliance could void the user's authority to operate the equipment. Note: This equipment has been tested and found to comply with the limits for a Class B digital device, pursuant to part 15 of the FCC Rules. These limits are designed to provide reasonable protection against harmful interference in a residential installation. This equipment generates uses and can radiate radio frequency energy and, if not installed and used in accordance with the instructions, may cause harmful interference to radio communications. However, there is no guarantee that interference will not occur in a particular installation. If this equipment does cause harmful interference to radio or television reception, which can be determined by turning the equipment off and on, the user is encouraged to try to correct the interference by one or more of the following measures:

- Reorient or relocate the receiving antenna.
 - Increase the separation between the equipment and receiver.
 - Connect the equipment into an outlet on a circuit different from that to which the receiver is connected.
 - Consult the dealer or an experienced radio/TV technician for help.
- The device has been evaluated to meet general RF exposure requirement. The device can be used in portable exposure condition without restriction.

This device contains licence-exempt transmitter(s)/ receiver(s) that comply with Innovation, Science and Economic Development Canada's licence-exempt RSS(s). Operation is subject to the following two conditions:

- (1) This device may not cause interference.
- (2) This device must accept any interference, including interference that may cause undesired operation of the device.

L'émetteur/récepteur exempt de licence contenu dans le présent appareil est conforme aux CNR d'Innovation, Sciences et Développement économique Canada applicables aux appareils radio exempts de licence. L'exploitation est autorisée aux deux conditions suivantes:

- (1) L'appareil ne doit pas produire de brouillage;
- (2) L'appareil doit accepter tout brouillage radioélectrique subi, même si le brouillage est susceptible d'en compromettre le fonctionnement.