



KLIM BOOMBOX B3

USER MANUAL - MANUEL D'UTILISATION
BENUTZERHANDBUCH - MANUALE - MANUAL

INDEX

ENGLISH

Safety warnings	2
Controls and specifications	3
First use	4
CD & Bluetooth modes	5
Radio & AUX input	6
Headphones & USB modes	7

FRANÇAIS

Consignes de sécurité	8
Commandes et spécifications	9
Première utilisation	10
Modes CD et Bluetooth	11
Radio et entrée auxiliaire	12
Casque et mode USB	13

DEUTSCH

Sicherheitshinweise	14
Steuerungen und Eigenschaften	15
Vor dem ersten Gebrauch	16
CD und Bluetooth	17
Radio und Aux-Eingang	18
Kopfhörer und USB-modus	19

ITALIANO

Avvertenze di sicurezza	20
Comandi e specifiche	21
Primo utilizzo	22
Modalità CD e bluetooth	23
Radio e ingresso AUX	24
Headphones & USB modes	25

ESPAÑOL

Advertencias de seguridad	26
Controles y especificaciones	27
Puesta en marcha	28
Modos CD y Bluetooth	29
Radio y entrada auxiliar	30
Auriculares y modo USB	31

SAFETY WARNINGS



This symbol indicates that there are important operating and maintenance instructions in the manual accompanying this device.



Do not expose this unit to rain, moisture, or humid environments, to prevent fire or shock hazards.



This symbol indicates that dangerous voltage constituting a risk of electric shock is present within this unit. **CAUTION:** to prevent electric shock, carefully insert the plug correctly into a matching socket or adapter of suitable voltage.



This product utilizes a Class 1 laser to read Compact Discs. Invisible laser radiation is present when the CD player is open, and the system's interlock has failed or has been damaged. Avoid direct exposure to the laser beam at all times.



Replace the battery only with the same or equivalent type; only use comparable rechargeable 1.2 V C-type batteries. **CAUTION:** Never mix batteries of different types (we recommend Ni-MH 1.2 V batteries). Do not use conventional 1.5 V C type batteries as they might damage the device.



There are no user-serviceable parts inside the unit; dismantling it will void your warranty. If you face any issues with the device, please contact the manufacturer directly. We are at your disposal every day and our specialists always reply within 24 hours. Remember that your KLIM Boombox is covered by a dependable 5-year warranty.

CONTROLS AND SPECIFICATIONS

LOCATION OF CONTROLS

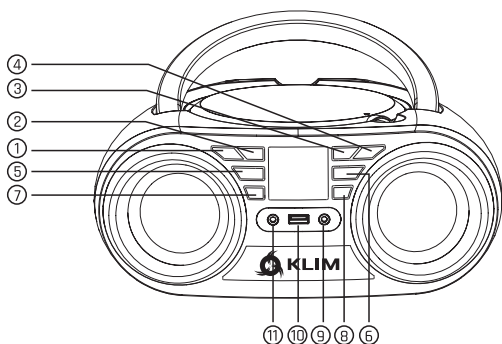

1. POWER/RGB LIGHTS
2. PREV
3. NEXT
4. PLAY/PAUSE/P+/SCAN
5. VOL-
6. VOL+
7. EQ/MODE
8. STOP/REP/MEM
9. AUX-OUT PORT
10. USB PORT
11. AUX-IN

SPECIFICATIONS











AC voltage: 110-240 V 50/60 Hz

Battery capacity: 10.000 mAh (2500 mAh x 4) / 4.8 V

Speaker power: 1.5 W x 2 (total 3 W)

Speaker signal: stereo

FEATURES

	Compatible with USB drives containing MP3/WMA files		EQ intelligent digital sound switching
	Supports CD-Audio, CD-R, CD-RW playback		Input and output auxiliary ports for 3.5 mm jacks
	Built-in FM radio function with adjustable frequency band		Colorful RGB light design around both speakers
	Compatible with Bluetooth-enabled devices (BT 4.2)		Includes 4 NiMH rechargeable batteries (No.2 - Type C)
	LCD display and electronic digital volume control		Includes battery recharge and circuit protection

FIRST USE

1. POWER UP

The KLIM Boombox can be powered up via AC power or batteries.

AC POWER

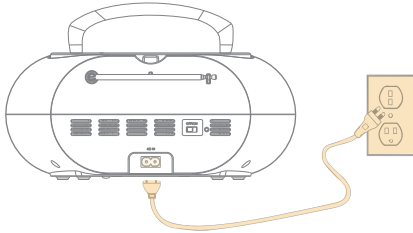

Plug the AC cord into a standard AC outlet (100-240V - 50/60 Hz)

RECHARGEABLE BATTERIES

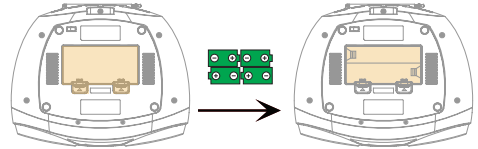

1. Open the battery compartment cover.
2. Take out the included batteries.
3. Remove the protective film from the batteries.
4. Insert the four batteries as shown above.
5. Close the battery compartment cover.

Main Switch (On/Off):

Move the switch to the right side to put the device in standby mode. Keep the device switched off when not in use to extend battery life.

AC power indicator: the red LED indicator lights up when the device is connected to an AC power source.

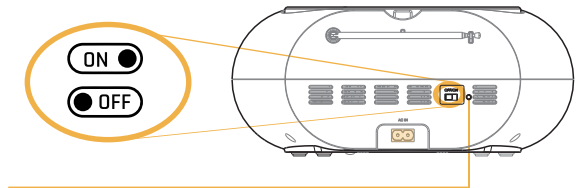

2. TURN ON THE BOOMBOX

While on standby mode, press the power button once to turn on the boombox.



Tip: to turn off the lights around the speaker, press and hold the power button for 3 seconds while the device is on.

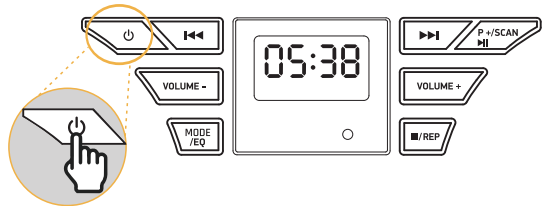

The KLIM Boombox has a battery recharging system that recharges the batteries when plugged in using the AC cord. If you plan to use the Boombox mainly while connected to an AC source for an extended period, we recommend removing the rechargeable batteries to preserve them.

CD & BLUETOOTH MODES

USING THE CD PLAYER

CD
MODE

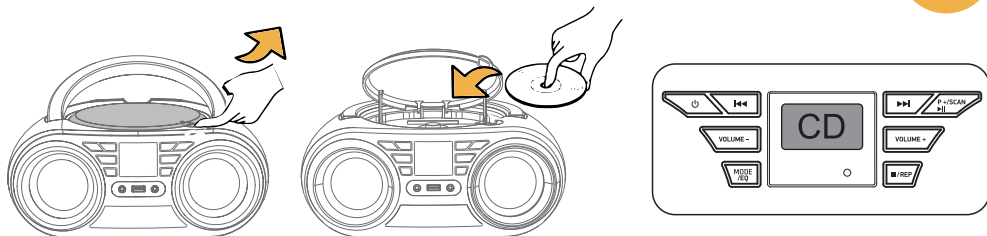

Step 1: Open the CD compartment.

Step 2: Place the CD inside and close the compartment.



Step 3: Press MODE and select CD mode.



Step 4: Press PLAY/PAUSE button to play the loaded CD.



Press once to go to the previous/next track.



Press and hold to fast-forward or rewind the current track.



While playing a track, press once for single-track repeat (ONE). Press again for playlist repeat (ALL). Press again to cancel this function (OFF). Press and hold to completely stop playback.

BLUETOOTH MODE

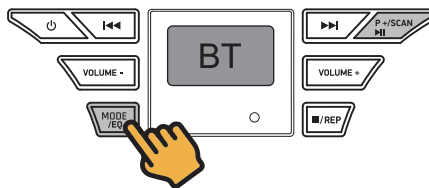

Step 1: Activate Bluetooth on your phone or tablet.

Step 3: Find "KLIM Boombox B3" in the available devices list and select it to pair with the boombox.



Step 2: Press MODE and select BT mode.



Step 4: Press the PLAY/PAUSE button to play or pause the current track. Press and hold to disconnect the pair device.



Some playback features such as fast-forward or rewind may not function, depending on the connected device.

RADIO & AUX INPUT



USING THE RADIO

Step 1: Press the MODE button and select RAD, then extend the FM antenna to improve radio reception.

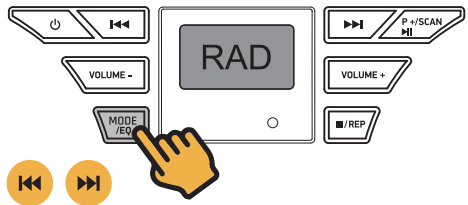

Step 2: Long press PREV or NEXT buttons to jump to the previous or next available station. Short press to manually select the frequency.

SETTING RADIO STATION PRESETS (AUTOMATIC MODE)



Press and hold the PLAY/PAUSE button to auto-scan available FM frequencies. All detected frequencies will be saved to presets P01 to P20. Once the auto-scan has finished, briefly press the PLAY/PAUSE button to cycle through all saved presets.

SETTING RADIO STATION PRESETS (MANUAL MODE)



Step 1: select the desired frequency using these buttons, as explained earlier.



Step 2: briefly press the REP button to enter memory mode. When the on-screen text flashes, wait for 2 seconds, then press the button again to save the current frequency to a preset (e.g. P01 to 105.3). Note: you can press the PLAY/PAUSE button while the numbers are flashing to select which preset you want to save the station to.



Step 3: briefly press the PLAY/PAUSE button to select a preset FM station, and repeat to move to the next station (P01 to P20).

AUXILIARY PORT (IN)

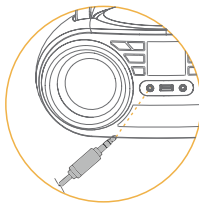

Step 1: connect a 3.5 mm cable (not included) to the AUX port on the KLIM Boombox.

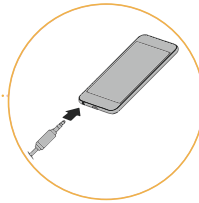

Step 2: Connect the other end to the output auxiliary port on your device (such as an Mp3 player)

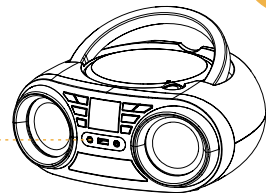

Step 3: Press the MODE button to select AUX mode. Audio played through the connected device will now sound through the boombox.

HEADPHONES & USB MODES

AUXILIARY PORT (OUT)

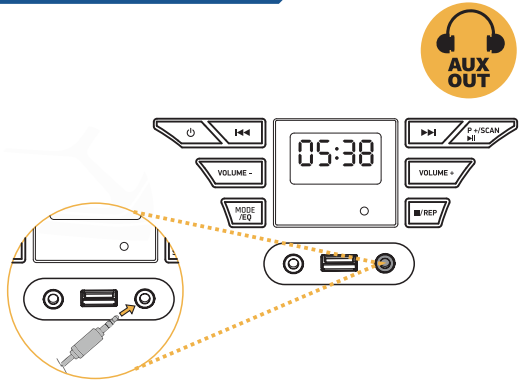

Use this port to connect external earphones to the boombox. Simply plug in the 3.5 mm jack to the AUX port on the right and the sound will play through the connected earphones. You may also use this auxiliary output port to connect the boombox to other compatible devices with a 3.5 mm jack.

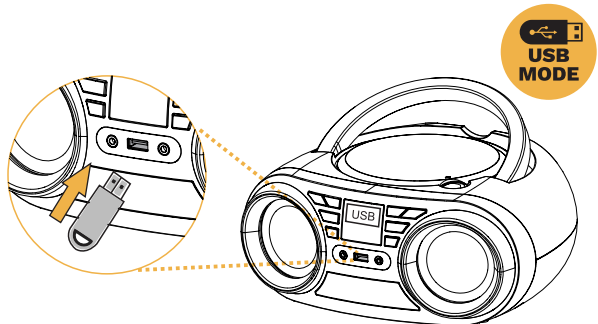

USB PLAYBACK

Press the EQ/MODE button to select USB mode and plug in a USB flash drive with your music selection. The KLIM Boombox is compatible with Mp3 and WMA audio file formats.



  Press once to go to the next or previous track. Press and hold to fast-forward or rewind the current track.

 While playing a track, press once for single-track repeat. Press again for playlist repeat. Press again to cancel this function. Press and hold to completely stop playback.



On any playback mode, press and hold the EQ/MODE key to change equalization settings: FLAT / CLASSICAL / JAZZ / ROCK / POP

CONTACT AND TROUBLESHOOTING



If you ever encounter any trouble with this device or any of our products, remember that we are at your disposal and ready to help you with any issue. Contact us at support@klimtechnologies.com for assistance. Our specialists always reply within 24 hours. And don't forget that the KLIM Boombox is covered by a dependable 5-year warranty.

CONSIGNES DE SÉCURITÉ



Ce symbole indique que le manuel qui accompagne cet appareil contient des instructions d'utilisation et d'entretien importantes.



N'exposez pas cet appareil à la pluie, à l'humidité ou à un environnement humide, afin d'éviter tout risque d'incendie ou d'électrocution.



Ce symbole indique que cet appareil contient une tension dangereuse pouvant entraîner une électrocution. ATTENTION : pour éviter tout risque d'électrocution, insérez soigneusement la fiche dans une prise ou un adaptateur ayant une tension appropriée.



Ce produit utilise un laser de classe 1 pour lire les disques compacts. Un rayonnement laser invisible est présent lorsque le lecteur de CD est ouvert et que le verrouillage du système ne fonctionne pas ou a été endommagé. Évitez à tout moment l'exposition directe au rayon laser.



Ne remplacez la batterie que par une batterie de type identique ou équivalent : n'utilisez que des batteries rechargeables comparables de type C de 1,2 V. ATTENTION : Ne mélangez jamais des batteries de différents types (nous recommandons des batteries Ni-MH de 1,2 V). N'utilisez pas de batteries classiques de type C de 1,5 V, car elles pourraient endommager l'appareil.



L'appareil ne contient aucune pièce réparable par l'utilisateur ; le démontage de l'appareil annulera votre garantie. Si vous rencontrez des problèmes avec l'appareil, veuillez contacter directement le fabricant. Nous sommes à votre disposition tous les jours et nos spécialistes vous répondent toujours dans les 24 heures. N'oubliez pas que votre KLIM Boombox est couverte par une garantie de 5 ans.

COMMANDES ET SPÉCIFICATIONS

EMPLACEMENT DES COMMANDES

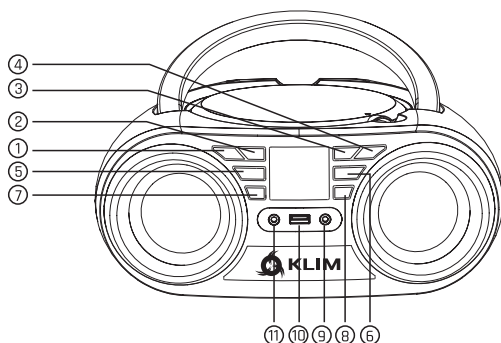

1. ÉCLAIRAGE ALIMENTATION/RGB
2. PREV
3. NEXT
4. PLAY/PAUSE/P+/SCAN
5. VOL -
6. VOL +
7. EQ/MODE
8. STOP/REP/MEM
9. CONNEXION AUXILIAIRE (SORTIE)
10. PORT USB
11. CONNEXION AUXILIAIRE (ENTRÉE)

SPÉCIFICATIONS











Tension AC : 110-240v 50/60 Hz

Capacité de la batterie : 10 000 mAh (2 500 mAh x 4) / 4,8 V

Puissance du haut-parleur : 1,5 W x 2 (total 3 W)

Signal du haut-parleur : stéréo

CARACTÉRISTIQUES

	Compatible avec les clés USB contenant des fichiers MP3/WMA		Egaliseur Numérique 5 modes
	Supporte les CD-Audio, CD-R. Lecture de CD-RW		Ports audio stereo AUX-in et AUX-out avec prise jack
	Fonction radio FM intégrée avec bande de fréquence réglable		Design lumineux RGB coloré autour des deux haut-parleurs
	Compatible avec les appareils compatibles Bluetooth (BT 4.2)		4 batteries rechargeables NiMH (n°2 - Type C) incluses
	Écran LCD et contrôle électronique du volume numérique		Recharge de la batterie et protection du circuit incluses

PREMIÈRE UTILISATION

1. MISE EN MARCHÉ

La KLIM Boombox peut être alimentée en courant alternatif ou avec des batteries.

ALIMENTATION À COURANT ALTERNATIF

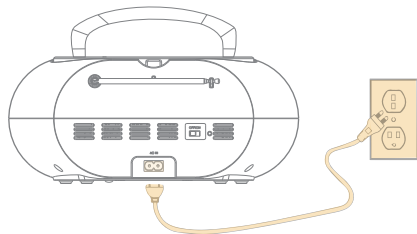

Branchez le cordon d'alimentation dans une prise de courant alternatif standard (100-240V - 50/60 Hz)

Interrupteur principal (On/Off) :

Déplacez l'interrupteur sur le côté droit pour mettre l'appareil en mode veille. Maintenez l'appareil éteint lorsqu'il n'est pas utilisé pour prolonger la durée de vie de la batterie.

Voyant d'alimentation : le voyant LED rouge s'allume lorsque l'appareil est branché à une source d'alimentation.

BATTERIES RECHARGEABLES

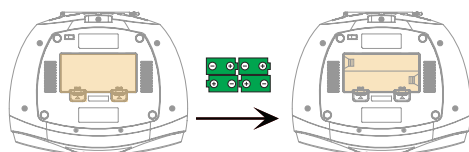

1. Ouvrez le couvercle du compartiment de la batterie.
2. Retirez les batteries fournies.
3. Retirez le film de protection des batteries.
4. Insérez les quatre batteries comme indiqué ci-dessus.
5. Fermez le couvercle du compartiment des batteries.

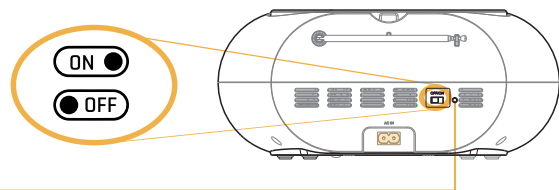

2. ALLUMEZ LA BOOMBOX

En mode veille, appuyez une fois sur le bouton d'alimentation pour allumer la boombox.



Conseil : pour éteindre les lumières autour du haut-parleur, pressez le bouton d'alimentation pendant 3 secondes lorsque l'appareil est allumé.

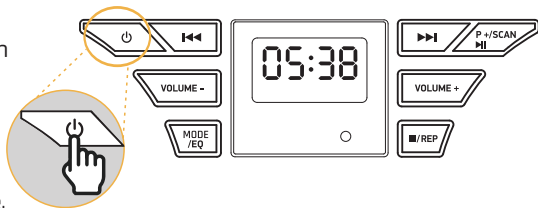

La KLIM Boombox est dotée d'un système de recharge des batteries qui les recharge lorsqu'elle est branchée en utilisant le cordon d'alimentation. Si vous prévoyez d'utiliser la Boombox principalement lorsqu'elle est connectée à une source de courant alternatif pendant une période prolongée, nous vous recommandons de retirer les batteries rechargeables afin de prolonger leur durée de vie.

MODES CD ET BLUETOOTH

UTILISATION DU LECTEUR CD

CD
MODE

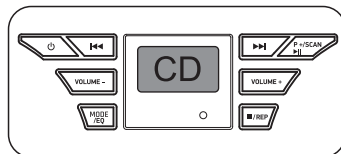
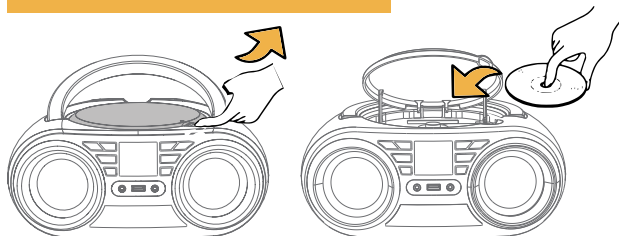

Étape 1 : Ouvrez le compartiment de CD.

Étape 2 : Placez le CD à l'intérieur puis refermez le compartiment.



Étape 3 : Appuyez sur MODE et sélectionnez le mode CD.



Étape 4 : Appuyez sur PLAY/PAUSE pour lire le CD chargé.



Appuyez une fois pour passer à la piste précédente/suivante.

Maintenez cette touche appuyée pour faire une avance rapide ou un retour en arrière sur la piste en cours.



Pendant la lecture d'une piste, appuyez une fois pour répéter une piste (ONE). Appuyez à nouveau sur cette touche pour répéter la liste de lecture (ALL). Appuyez à nouveau sur cette touche pour annuler cette fonction (OFF). Maintenez cette touche appuyée pour arrêter complètement la lecture.

MODE BLUETOOTH

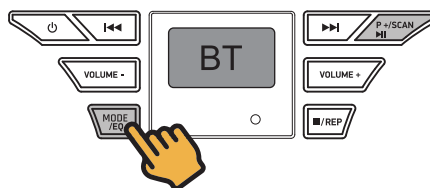

Étape 1 : Activez le Bluetooth sur votre téléphone ou votre tablette.

Étape 3 : Trouvez « KLIM Boombox B3 » dans la liste des appareils disponibles et sélectionnez-le pour le coupler avec la boombox.



Étape 2 : Appuyez sur MODE et sélectionnez le mode BT.



Étape 4 : Appuyez sur le bouton PLAY/PAUSE pour lire ou mettre en pause la piste en cours. Maintenez la touche appuyée pour déconnecter le dispositif couplé.



Certaines fonctions de lecture telles que l'avance ou le retour rapide peuvent ne pas fonctionner, selon l'appareil connecté.

RADIO ET ENTRÉE AUXILIAIRE



UTILISATION DE LA RADIO

Étape 1 : Appuyez sur le bouton MODE et sélectionnez RAD, puis déployez l'antenne FM pour améliorer la réception radio.

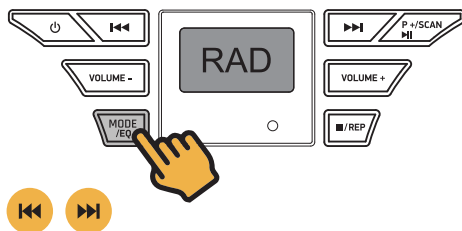

Étape 2 : Appuyez longuement sur les boutons PREV ou NEXT pour passer à la station disponible précédente ou suivante. Appuyez brièvement sur la touche pour sélectionner manuellement la fréquence.

RÉGLAGE DES PRÉSÉLECTIONS DES STATIONS DE RADIO (AUTOMATIQUE)



Pressez et maintenez la touche PLAY/PAUSE pour balayer automatiquement les fréquences FM disponibles. Toutes les fréquences détectées seront enregistrées dans les présélections P01 à P20. Une fois la recherche automatique terminée, appuyez brièvement sur PLAY/PAUSE pour faire défiler toutes les présélections sauvegardées.

RÉGLAGE DES PRÉSÉLECTIONS DES STATIONS DE RADIO (MANUAL)



Étape 1 : sélectionnez la fréquence souhaitée à l'aide de ces boutons, comme expliqué précédemment.



Étape 2 : appuyez brièvement sur la touche REP pour entrer en mode mémoire. Lorsque le texte à l'écran clignote, attendez 2 secondes, puis appuyez à nouveau sur le bouton pour enregistrer la fréquence actuelle dans une présélection (par exemple P01 à 105.3). Remarque: vous pouvez appuyer sur la touche PLAY/PAUSE pendant que les numéros clignotent pour sélectionner le numéro de présélection dans lequel vous souhaitez enregistrer la station.



Étape 3 : appuyez brièvement sur la touche PLAY/PAUSE pour sélectionner une station FM préséglée, puis répétez l'opération pour passer à la station suivante (P01 à P20).

PORT AUXILIAIRE (IN)

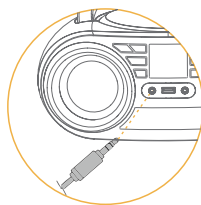

Étape 1 : connectez un câble de 3,5 mm (non fourni) au port AUX de la KLIM Boombox.

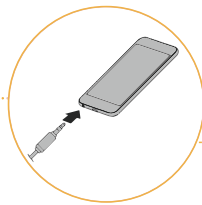

Étape 2 : Connectez l'autre extrémité au port auxiliaire de sortie de votre appareil (comme un lecteur MP3).

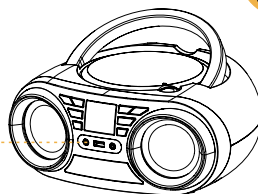

Étape 3 : Appuyez sur la touche MODE pour sélectionner le mode AUX. Le son diffusé par l'appareil connecté sonnera maintenant dans la boombox.

CASQUE ET MODE USB

PORT AUXILIAIRE (OUT)

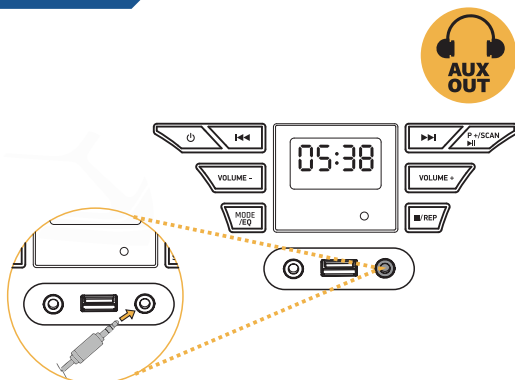

Utilisez ce port pour connecter des écouteurs externes à la boombox. Il suffit de brancher la prise jack de 3,5 mm au port AUX de droite et le son sera diffusé par les écouteurs connectés. Vous pouvez également utiliser ce port de sortie auxiliaire pour connecter la boombox à d'autres appareils compatibles avec une prise jack de 3,5 mm.

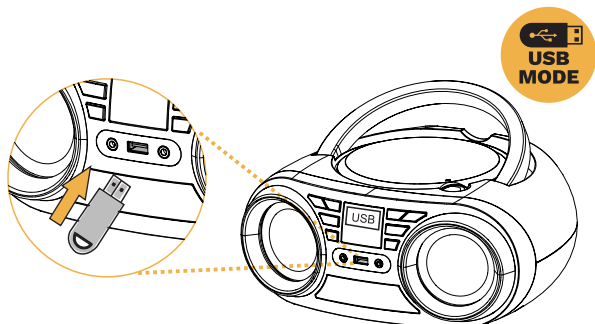

LECTURE USB

Appuyez sur la touche EQ/MODE pour sélectionner le mode USB et branchez une clé USB avec votre sélection de musique. La KLIM Boombox est compatible avec les formats de fichiers audio MP3 et WMA.



  Appuyez une fois pour passer à la piste suivante ou précédente. Maintenez cette touche appuyée pour faire une avance rapide ou un retour en arrière sur la piste en cours.

 Pendant la lecture d'une piste, appuyez une fois pour répéter une piste. Appuyez à nouveau sur cette touche pour répéter la liste de lecture. Appuyez à nouveau sur cette touche pour annuler cette fonction. Maintenez cette touche appuyée pour arrêter complètement la lecture.



Dans n'importe quel mode de lecture, appuyez et maintenez la touche EQ/MODE pour modifier les paramètres d'égalisation (FLAT / CLASSICAL / JAZZ / ROCK / POP)

CONTACT ET DÉPANNAGE



Si jamais vous rencontrez un problème avec cet appareil ou l'un de nos produits, n'oubliez pas que nous sommes à votre disposition et prêts à vous aider pour toute question. Contactez-nous à l'adresse france@klimtechnologies.com pour obtenir de l'aide. Nos spécialistes vous répondront toujours dans les 24 heures. Enfin, n'oubliez pas que la KLIM Boombox est couverte par une garantie fiable de 5 ans.



Dieses Symbol weist auf wichtige Bedienungs- und Wartungshinweise in der Anleitung zu diesem Gerät hin.



Das Gerät nicht Regen, Feuchtigkeit oder feuchten Umgebungen aussetzen, um Brand- oder Stromschlaggefahren zu vermeiden.



Dieses Symbol weist darauf hin, dass eine gefährliche Spannung an diesem Gerät anliegt, die die Gefahr eines elektrischen Schlags mit sich bringt. **ACHTUNG:** Um einen elektrischen Schlag zu vermeiden, den Stecker vorsichtig und korrekt in eine passende Steckdose oder einen geeigneten Spannungsadapter stecken.



Dieses Produkt verwendet einen Laser der Klasse 1 zum Lesen von CDs. Wenn der CD-Player geöffnet ist und die Verriegelung des Systems ausgefallen oder beschädigt ist, gibt es unsichtbare Laserstrahlungen. Stets die direkte Einwirkung des Laserstrahls vermeiden.



Die Batterie nur durch denselben oder einen gleichwertigen Typ ersetzen: Nur vergleichbare wiederaufladbare 1,2V-C-Batterien verwenden. **ACHTUNG:** Niemals Akkus verschiedener Typen mischen (wir empfehlen Ni-MH 1,2V-Akkus). Keine herkömmlichen 1,5V-C-Batterien verwenden. Sie können das Gerät beschädigen.



Das Gerät enthält keine Teile, die vom Benutzer gewartet werden können. Wenn Du das Gerät demontierst, erlischt die Garantie. Bei Problemen mit dem Gerät wende Dich bitte direkt an den Hersteller. Wir sind jeden Tag für Dich da und unsere Fachleute antworten immer innerhalb von 24 Stunden. Denke daran, dass Deine KLIM Boombox 5 Jahre Garantie hat.

STEUERUNGEN UND EIGENSCHAFTEN

STANDORT DER KONTROLLEN

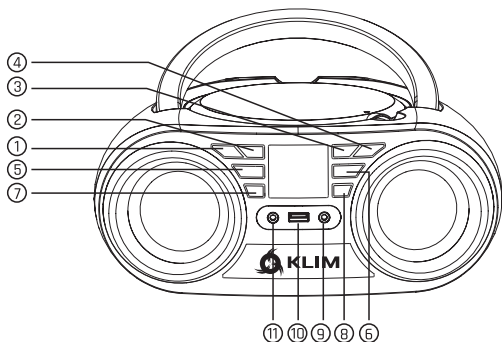

1. POWER/RGB-LICHTER
2. PREV
3. NEXT
4. PLAY/PAUSE/P+/SCAN
5. VOL-
6. VOL+
7. EQ/MODE
8. STOP/REP/MEM
9. AUX-ANSCHLUSS (AUSGANG)
10. USB-ANSCHLUSS
11. AUX-ANSCHLUSS (EINGANG)

TECHNISCHE DATEN







Netzstrom-Spannung: 110-240 V 50/60 Hz

Akkukapazität: 10.000 mAh (2500 mAh x 4) / 4,8 V

Leistung der Lautsprecher: 1,5 W x 2 (insgesamt 3 W)

Lautsprechersignal: Stereo

EIGENSCHAFTEN

	Kompatibel mit USB-Trägern, die MP3/WMA-Dateien enthalten		EQ intelligente digitale Klangumschaltung
	Unterstützt CD-Audio-, CD-R-, CD-RW-Wiedergabe		AUX-IN-Audioanschluss mit Stereo-Kopfhörerbuchse
	Eingebaute UKW-Radiofunktion (FM) mit einstellbarem Frequenzband		Buntes RGB-Lichtdesign um beide Lautsprecher
	Kompatibel mit Bluetooth-fähigen Geräten (BT 4.2)		Enthält 4 NiMH-Akkus (Nr. 2 - Typ C)
	LCD-Display und elektronische digitale Lautstärkeregelung		Mit Akkuaufladung und Stromkreisschutz

VOR DEM ERSTEN GEBRAUCH

1. STROMVERSORGUNG

Die KLIM Boombox kann mit Netzstrom oder Akkus betrieben werden.

NETZSTROM

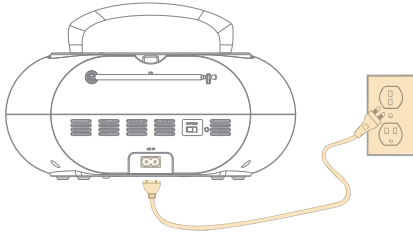

Das Netzkabel an eine Standard-Wechselstromsteckdose (100-240 V - 50/60 Hz) anschließen

Hauptschalter (Ein/Aus):

Den Schalter nach rechts schieben, um das Gerät in den Bereitschaftsmodus zu setzen. Das Gerät ausgeschaltet lassen, wenn es nicht benutzt wird, um die Lebensdauer der Akkus zu verlängern.

Netzstromanzeige: Wenn das Gerät an eine Netzstromquelle angeschlossen ist, leuchtet die rote LED-Anzeige.

WIEDERAUFLADBARE BATTERIEN

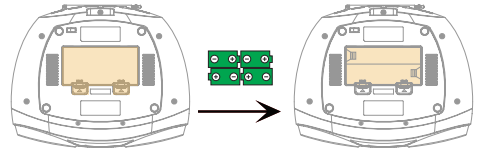

1. Den Batteriefachdeckel öffnen.
2. Die mitgelieferten Batterien herausnehmen.
3. Die Schutzfolie von den Batterien entfernen.
4. Die vier Batterien wie oben dargestellt einlegen.
5. Den Batteriefachdeckel schließen.

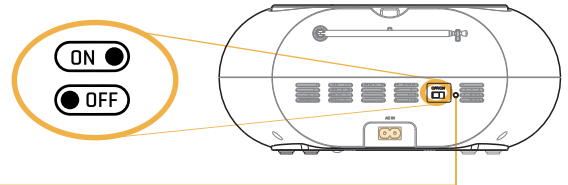

2. DIE BOOMBOX ANSTELLEN

Im Standby Modus drückst du einmal auf die Einschalttaste, um die Boombox einzuschalten.



Tipp: Um die Beleuchtung um den Lautsprecher herum auszuschalten, halte die Einschalttaste 3 Sekunden lang gedrückt, während das Gerät eingeschaltet ist.

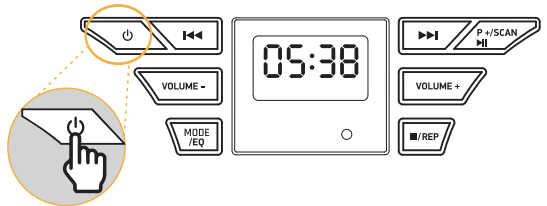

Die KLIM Boombox verfügt über ein Akkuladesystem, das die Akkus wieder auflädt, wenn die Box über das Netzkabel angeschlossen wird. Wenn die Boombox längere Zeit hauptsächlich am Netz betrieben werden soll, empfehlen wir, die Akkus herauszunehmen, um sie zu schonen.

BEDIENUNG DES CD-PLAYERS

CD
MODE

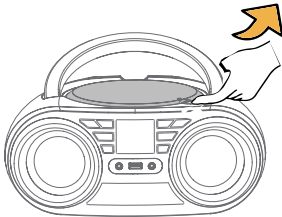

Schritt 1: CD-Fach öffnen.

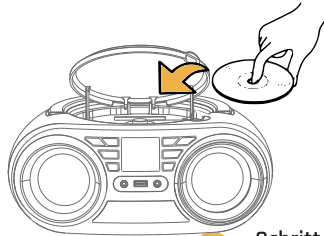

Schritt 2: CD einlegen und das Fach schließen.

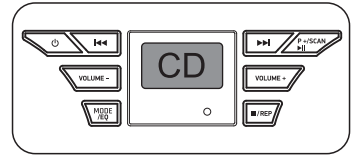

EQ/
MODE

Schritt 3: MODE drücken und den CD-Modus wählen.

▶||

Schritt 4: PLAY/PAUSE drücken, um die eingelegte CD abzuspielen.



Ein Mal drücken, um zum vorherigen/nächsten Titel zu wechseln.



Die Taste gedrückt halten, um den aktuellen Titel schnell vor- oder zurückzuspulen.



Während der Wiedergabe eines Titels ein Mal drücken, um einen Titel zu wiederholen (ONE). Erneut drücken, um die Wiedergabeliste zu wiederholen (ALL). Erneut drücken, um diese Funktion abzubrechen (OFF). Die Taste gedrückt halten, um die Wiedergabe vollständig zu stoppen.

BLUETOOTH-MODUS



Schritt 1: Aktiviere das Bluetooth auf Deinem Handy oder Tablet.

Schritt 3: „KLIM Boombox B3“ in der Liste der verfügbaren Geräte suchen und zum Koppeln mit der Boombox auswählen.

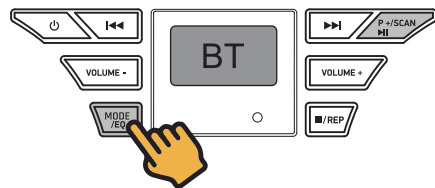

EQ/
MODE

Schritt 2: MODE drücken und den BT-Modus wählen.

▶||

Schritt 4: Die PLAY/PAUSE-Taste drücken, um den aktuellen Titel abzuspielen oder anzuhalten. Die Taste gedrückt halten, um die Verbindung mit dem gekoppelten Gerät zu trennen.



Je nach angeschlossenem Gerät kann es sein, dass manche Wiedergabefunktionen wie schneller Vor- oder Rücklauf nicht funktionieren.

RADIO UND AUX-EINGANG



BEDIENUNG DES RADIOS

Schritt 1: Die MODE-Taste drücken und RAD wählen. Die FM-Antenne ausfahren, um den Radioempfang zu verbessern.

Schritt 2: Lange die Tasten PREV oder NEXT drücken, um zum vorherigen oder nächsten verfügbaren Sender zu springen. Kurz drücken, um die Frequenz manuell auszuwählen.

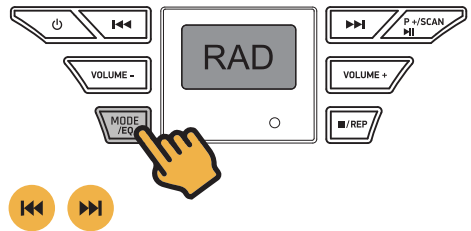

EINSTELLEN VON RADIOSENDER-VOREINSTELLUNGEN (AUTOMATISCH)



Drücke und halte die PLAY/PAUSE Taste, um die verfügbaren FM-Frequenzen automatisch zu scannen. Alle gefundenen Frequenzen werden auf den Presets P01 bis P20 gespeichert. Sobald der automatische Suchlauf beendet ist, drücke kurz die PLAY/PAUSE Taste, um durch alle gespeicherten Presets zu gehen.

EINSTELLEN VON RADIOSENDER-VOREINSTELLUNGEN (MANUELL)



Schritt 1: Mit den entsprechenden Tasten wie zuvor beschriebenen die gewünschte Frequenz auswählen.



Schritt 2: Kurz die REP-Taste drücken, um in den Speichermodus zu gelangen. Wenn der Text auf dem Bildschirm blinkt, 2 Sekunden warten und danach erneut die Taste drücken, um die aktuelle Frequenz in einer Voreinstellung (z. B. P01 bis 105.3) zu speichern. Hinweis: Du kannst die PLAY/PAUSE-Taste drücken, während die Zahlen blinken, um auszuwählen, auf welchem Preset du den Sender speichern möchtest.



Schritt 3: Kurz die PLAY/PAUSE-Taste drücken, um einen voreingestellten FM-Sender auszuwählen. Den Vorgang wiederholen, um zum nächsten Sender zu wechseln.

HILFSANSCHLUSS (EINGANG)

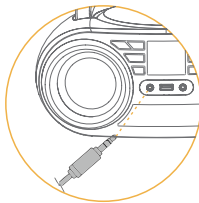

Schritt 1: Ein 3,5mm-Kabel (nicht im Lieferumfang enthalten) an den AUX-Anschluss der KLIM Boombox anschließen.

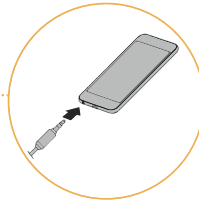

Schritt 2: Das andere Ende mit dem Hilfsausgang Ihres Geräts (z. B. einem MP3-Player) verbinden.

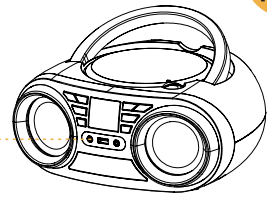

Schritt 3: Die MODE-Taste drücken und den AUX-Modus wählen. Der über das angeschlossene Gerät abgespielte Ton wird nun über die Boombox wiedergegeben.

KOPFHÖRER UND USB-MODUS

HILFSANSCHLUSS (AUSGANG)

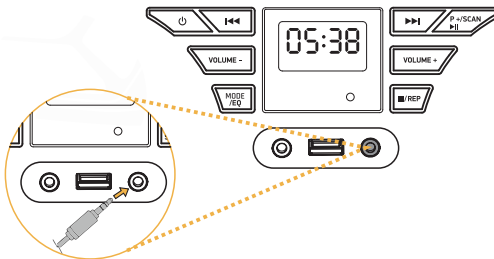

Über diesen Anschluss können externe Kopfhörer an die Boombox angeschlossen werden. Einfach den 3,5mm-Klinkenstecker in den AUX-Anschluss auf der rechten Seite stecken, und der Ton wird über die angeschlossenen Kopfhörer wiedergegeben. Du kannst diesen Hilfsausgang auch verwenden, um die Boombox mit anderen kompatiblen Geräten mit einem 3,5mm-Stecker zu verbinden.

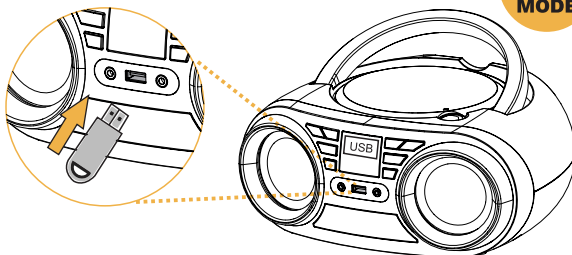

USB-WIEDERGABE

Die EQ/MODE-Taste drücken, um den USB-Modus auszuwählen, und einen USB-Stick mit Deiner Musikauswahl einstecken. Die KLIM Boombox ist mit den Audiodateiformaten Mp3 und WMA kompatibel.



  Ein Mal drücken, um zum nächsten bzw. zum vorherigen Titel zu wechseln. Die Taste gedrückt halten, um den aktuellen Titel schnell vor- oder zurückzuspulen.

 Während der Wiedergabe eines Titels ein Mal drücken, um einen Titel zu wiederholen. Erneut drücken, um die Wiedergabeliste zu wiederholen. Erneut drücken, um diese Funktion abzubrechen. Die Taste gedrückt halten, um die Wiedergabe vollständig zu stoppen.



Drücke in einem beliebigen Wiedergabemodus, Die Taste EQ/MODE gedrückt halten, um die Klangeinstellungen zu ändern (FLAT / CLASSICAL / JAZZ / ROCK / POP).

KONTAKT & FEHLERBEHEBUNG



Solltest du jemals Probleme mit diesem Gerät oder einem unserer Produkte haben, denke daran, dass wir dir zur Verfügung stehen und bereit sind, dir bei jedem Problem zu helfen. Kontaktiere uns unter deutschland@klimtechnologies.com für Hilfe. Unsere Spezialisten antworten immer innerhalb von 24 Stunden. Und vergiss nicht, dass die KLIM Boombox von einer zuverlässigen 5-Jahres-Garantie abgedeckt ist.



Questo simbolo indica che nel manuale a corredo del dispositivo sono riportate importanti istruzioni per l'uso e la manutenzione.



Per scongiurare il rischio di scosse o incendi, non esporre l'unità alla pioggia, all'umidità o ad ambienti umidi.



Questo simbolo indica la presenza di tensione pericolosa nell'unità e il conseguente rischio di scossa elettrica. **ATTENZIONE:** per evitare scosse elettriche, avere cura di inserire correttamente la spina in una presa compatibile o un adattatore della tensione adeguata.



Questo prodotto impiega un laser di Classe 1 per la lettura dei compact disc. È presente una radiazione laser invisibile quando il lettore CD è aperto e l'interblocco del sistema è guasto o ha subito dei danni. Evitare in ogni momento l'esposizione diretta al raggio laser.



Sostituire le batterie soltanto con altre batterie dello stesso tipo o equivalenti: usare esclusivamente batterie ricaricabili di tipo C da 1,2 V compatibili. **ATTENZIONE:** mai utilizzare insieme batterie di tipi diversi (si consigliano batterie Ni-MH da 1,2 V). Non usare batterie tradizionali di tipo C da 1,5 V poiché potrebbero danneggiare il dispositivo.



L'unità non include componenti riparabili dall'utente: il suo smontaggio rende nulla la garanzia. In caso di problemi con il dispositivo, rivolgersi direttamente al produttore. Siamo disponibili tutti i giorni e i nostri esperti sono pronti a rispondere 24 ore su 24. Si ricorda che il KLIM Boombox è coperto da un'affidabile garanzia di 5 anni.

COMANDI E SPECIFICHE

POSIZIONE DEI COMANDI

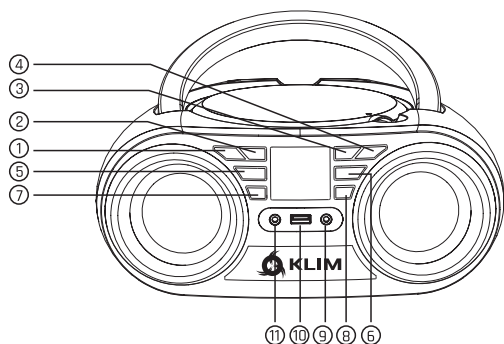

1. ACCENSIONE/LUCI RGB
2. PREC
3. SUCC
4. PLAY/PAUSA/P+/SCANSIONE
5. VOL-
6. VOL+
7. EQ/MODE
8. STOP/REP/MEM
9. AUX-OUT (USCITA STEREO)
10. PORTA USB
11. INGRESSO AUSILIARIO (AUX)

SPECIFICHE











Tensione CA: 110-240 V 50/60 Hz

Capacità batterie: 10.000 mAh (2500 mAh x 4)/4,8 V

Potenza altoparlante: 1,5 W x 2 (3 W totali)

Segnale altoparlante: stereo

CARATTERISTICHE

	Compatibile con unità USB contenenti file MP3/WMA		Modifica digitale del suono con EQ intelligente
	Riproduzione di supporti CD-Audio, CD-R, CD-RW		Ingresso ed uscita ausiliari stereo con jack 3.5 mm
	Funzione radio FM integrata con banda di frequenza regolabile		Design con luci RGB colorate attorno a entrambi gli altoparlanti
	Compatibile con dispositivi con funzione Bluetooth (BT 4.2)		Include 4 batterie NiMH ricaricabili (n. 2, tipo C)
	Display LCD e controllo digitale del volume		Include protezione del circuito e della ricarica delle batterie

PRIMO UTILIZZO

1. ALIMENTAZIONE

Il KLIM Boombox può essere alimentato attraverso cavo CA o batterie.

ALIMENTAZIONE CA

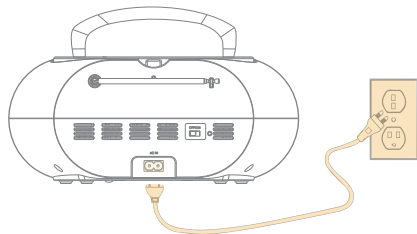

Inserire il cavo CA in una presa CA standard (100-240 V, 50/60 Hz)

Interruttore principale (On/Off):

Spostare l'interruttore a destra per mettere il dispositivo in standby. Per prolungare la vita utile delle batterie, tenere spento il dispositivo quando non in uso.

Spia alimentazione CA: la spia LED rossa si accende quando il dispositivo collegato ad una sorgente di alimentazione CA.

BATTERIE RICARICABILI

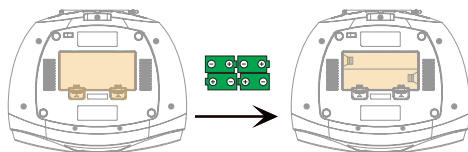

1. Aprire il coperchio del vano batterie.
2. Estrarre le batterie incluse.
3. Rimuovere la pellicola protettiva dalle batterie.
4. Inserire le quattro batterie come mostrato sopra.
5. Chiudere il coperchio del vano batterie.

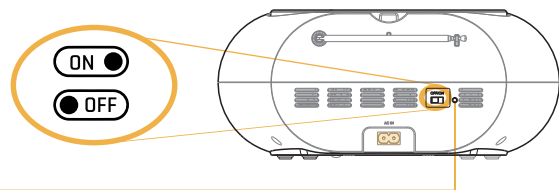

2. ACCENSIONE DEL BOOMBOX

In modalità standby, premi una volta sul pulsante d'accensione frontale per accendere il boombox.



Suggerimento: per spegnere le luci intorno agli altoparlanti, premi e tieni premuto il pulsante d'accensione per 3 secondi quando il dispositivo è acceso.

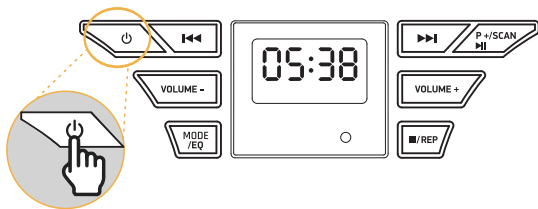

Il KLIM Boombox ha un sistema di ricarica delle batterie che fa sì che le batterie si ricarichino quando il dispositivo è collegato tramite cavo CA. Se si prevede di utilizzare a lungo il Boombox mentre è collegato ad una presa di corrente, è consigliabile rimuovere le batterie ricaricabili per preservarle.

MODALITÀ CD E BLUETOOTH

UTILIZZO DEL LETTORE CD

CD
MODE

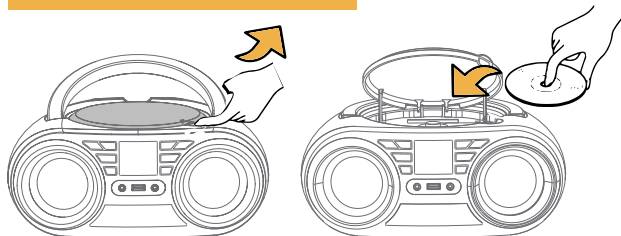

Passaggio 1: Aprire il vano CD.

Passaggio 2: Inserire il CD e chiudere il vano.

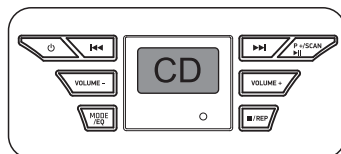

Passaggio 3: Premere il pulsante MODE e selezionare la modalità CD.



Passaggio 4: Premere PLAY/PAUSA per riprodurre il CD caricato.



Premere una volta per andare al brano precedente/successivo.

Tenere premuto per mandare avanti o indietro il brano corrente.



Durante la riproduzione di un brano, premere una volta per ripetere il singolo brano (ONE). Premere nuovamente per ripetere la playlist (ALL). Premere di nuovo per annullare questa funzione (OFF). Tenere premuto per interrompere completamente la riproduzione.

MODALITÀ BLUETOOTH



Passaggio 1: Attivare il Bluetooth sul telefono o sul tablet.

Passaggio 3: Nell'elenco dei dispositivi disponibili, individuare "KLIM Boombox B3" e selezionarlo per eseguire l'accoppiamento col Boombox.



Passaggio 2: Premere il pulsante MODE e selezionare la modalità BT.



Passaggio 4: Premere il pulsante PLAY/PAUSA per riprodurre o mettere in pausa il brano corrente. Tenere premuto per scollegare il dispositivo accoppiato.

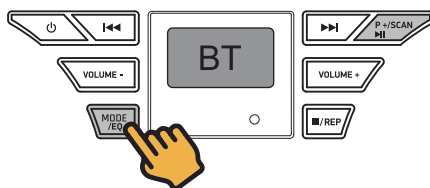

Alcune funzioni di riproduzione, ad esempio quella che permette di mandare avanti o indietro un brano, potrebbero non essere consentite con alcuni dispositivi.

UTILIZZO DELLA RADIO



Étape 1: Premere il pulsante MODE e selezionare RAD, quindi estrarre l'antenna FM per migliorare la ricezione del segnale radio.

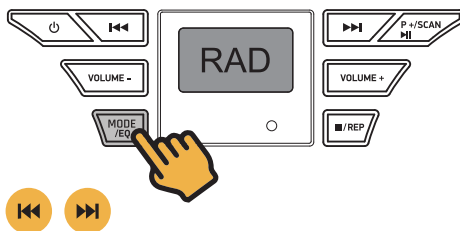

Étape 2: Tenere premuto a lungo il pulsante PREC o SUCC per andare alla stazione precedente o successiva disponibile. Premere brevemente per selezionare manualmente la frequenza.

IMPOSTAZIONE DI STAZIONI RADIO PREDEFINITE (AUTOMATICA)



Mantenere premuto il tasto PLAY/PAUSA per scansionare le frequenze FM disponibili. Tutte le frequenze rilevate saranno salvate nei preset da P01 a P20. Non appena la scansione automatica sarà terminata, premere brevemente il pulsante PLAY/Pausa per scorrere tra i preset salvati.

IMPOSTAZIONE DI STAZIONI RADIO PREDEFINITE (MANUALE)



Passaggio 1: Selezionare la frequenza desiderata utilizzando i pulsanti, come spiegato in precedenza.



Passaggio 2: Premere brevemente il pulsante REP per accedere alla modalità di memorizzazione. Quando il testo sullo schermo lampeggia, attendere 2 secondi, quindi premere di nuovo il pulsante per salvare la frequenza corrente in una posizione predefinita (ad es., 105.3 su P01). NOTA: È possibile premere il pulsante PLAY/PAUSA mentre i numeri lampeggiano a schermo per selezionare il preset nel quale salvare la stazione radio.



Passaggio 3: Premere brevemente il pulsante PLAY/PAUSA per selezionare una stazione FM predefinita e ripetere per passare alla stazione successiva (da P01 a P20).

PORTA AUSILIARIA (IN)

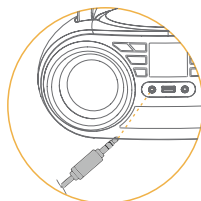

Passaggio 1: Collegare un cavo da 3,5 mm (non incluso) alla porta AUX del KLIM Boombox.

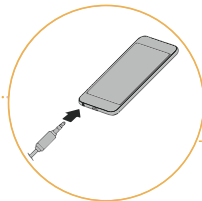

Passaggio 2: Collegare l'altra estremità del cavo alla porta ausiliaria di uscita del dispositivo (ad es. un lettore MP3).

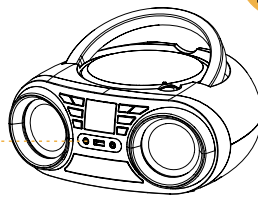

Passaggio 3: Premere il pulsante MODE per selezionare la modalità AUX. L'audio riprodotto attraverso il dispositivo collegato verrà emesso dal Boombox.

CUFFIE E MODALITÀ USB

PORTA AUSILIARIA (OUT)

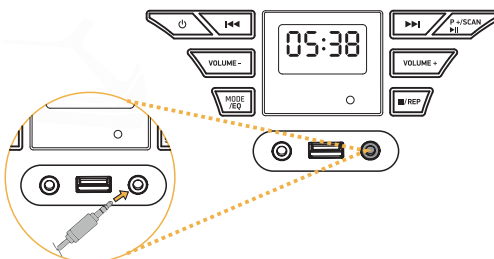

Utilizzare questa porta per collegare delle cuffie esterne al Boombox. Inserire il jack da 3,5 mm nella porta AUX a destra e l'audio sarà riprodotto attraverso le cuffie collegate. È possibile servirsi di questa porta di uscita ausiliaria per collegare il Boombox anche ad altri dispositivi compatibili tramite jack da 3,5 mm.

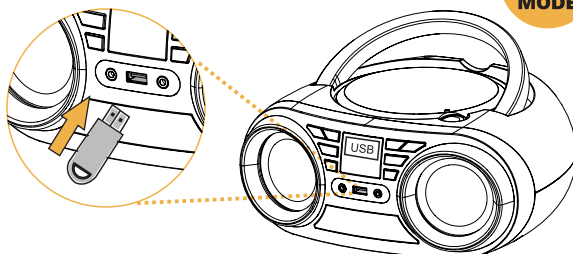

RIPRODUZIONE USB

Premere il pulsante EQ/MODE per selezionare la modalità USB e inserire un'unità flash USB contenente la musica che si desidera riprodurre. Il KLIM Boombox è compatibile con file audio nei formati MP3 e WMA.



  Premere una volta per andare al brano precedente o successivo. Tenere premuto per mandare avanti o indietro il brano corrente.

 Durante la riproduzione di un brano, premere una volta per ripetere il singolo brano. Premere nuovamente per ripetere la playlist. Premere di nuovo per annullare questa funzione. Tenere premuto per interrompere completamente la riproduzione.



In qualsiasi modalità di riproduzione, tenere premuto il tasto EQ/MODE per cambiare le impostazioni dell'equalizzazione (FLAT/CLASSICAL/JAZZ/ROCK/POP).

CONTATTO E RISOLUZIONE DEI PROBLEM



Se dovessi riscontrare un qualsiasi problema con questo o un altro dei nostri prodotti, ricorda che siamo sempre a completa disposizione per assisterti. Contattaci su italia@klimtechnologies.com per ottenere assistenza. I nostri specialisti ti risponderanno entro 24 ore. Non dimenticare che il KLIM Boombox è coperto da una solida garanzia di 5 anni.

ADVERTENCIAS DE SEGURIDAD



Este símbolo indica que hay importantes instrucciones de manejo y mantenimiento en el manual que acompaña al producto.



No expongas la unidad a la lluvia, humedad o ambientes de alta humedad para así evitar el riesgo de incendio o descargas eléctricas.



Este símbolo advierte de la presencia de voltaje peligroso en el interior de la unidad que podría constituir un riesgo de descarga eléctrica.

PRECAUCIÓN: para evitar una posible descarga eléctrica, inserta el enchufe con cuidado y de manera correcta en la toma de corriente o adaptador del voltaje adecuado.



Este producto emplea un láser Clase 1 para la lectura de CD. Si el sistema de bloqueo no funciona o está dañado, seguirá teniendo lugar radiación láser no visible cuando el reproductor de CD esté abierto. Evita la exposición directa al rayo láser en todo momento.



Sustituye las baterías únicamente por otras del mismo tipo o equivalentes: utiliza solo baterías recargables equivalentes del tipo 1,2 V C.

PRECAUCIÓN: nunca mezcles baterías de diversos tipos (recomendamos baterías Ni-MH 1,2 V). No utilices baterías convencionales del tipo 1,5 V C, ya que podrían dañar el dispositivo.



Dentro de la unidad no hay piezas reparables: si la desmontas, perderás la garantía. Si tuvieras cualquier problema con el dispositivo, ponte en contacto directamente con nosotros. Estamos a tu disposición todos los días: nuestros especialistas te responderán en menos de 24 horas. Recuerda que tu KLIM Boombox posee una garantía de 5 años.

CONTROLES Y ESPECIFICACIONES

UBICACIÓN DE LOS CONTROLES

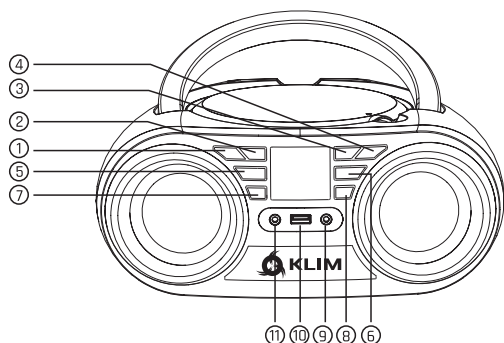

1. ENCENDIDO/LUCES RGB
2. PREV
3. NEXT
4. PLAY/PAUSE/P+/SCAN
5. VOL-
6. VOL+
7. EQ/MODE
8. STOP/REP/MEM
9. CONEXIÓN AUXILIAR (SALIDA)
10. PUERTO USB
11. CONEXIÓN AUXILIAR (ENTRADA)

ESPECIFICACIONES









Voltaje: 110-240 V 50/60 Hz

Capacidad de batería: 10.000 mAh (2500 mAh x 4) / 4,8 V

Potencia del altavoz: 1,5 W x 2 (3 W total)

Señal del altavoz: estéreo

CARACTERÍSTICAS

	Compatible con memorias USB que contengan archivos MP3/WMA		Ecualización inteligente
	Compatible con la reproducción de audio de CD, CD-R y CD-RW		Puertos de entrada y salida AUX para conexiones con jack de 3,5 mm
	Función de radio FM incorporada con banda de frecuencia ajustable		Luces RGB alrededor de los altavoces
	Compatible con dispositivos Bluetooth (BT 4.2)		Incluye cuatro baterías recargables NiMH (No.2 - Tipo C)
	Pantalla LCD y control digital de volumen		Incluye protección de circuitos y de carga de la batería

PUESTA EN MARCHA

1. ALIMENTACIÓN

El KLIM Boombox puede encenderse mediante conexión a la corriente o mediante baterías.

CONEXIÓN A LA CORRIENTE

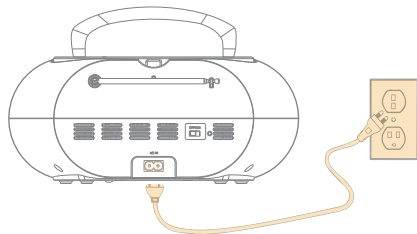

Conecta el cable de alimentación a un enchufe estándar (100-240 V - 50/60 Hz).

Interruptor principal (On/Off):

Mueve el interruptor a la derecha para activar el modo reposo del dispositivo. Mantén el dispositivo apagado cuando no se esté utilizando para ampliar la duración de la batería.

Indicador de corriente: el LED rojo se ilumina cuando el dispositivo está conectado a la corriente eléctrica.

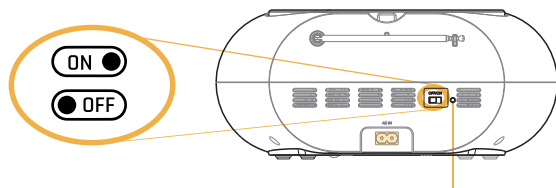

BATERÍAS RECARGABLES

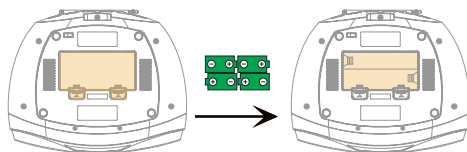

1. Abre la tapa del compartimento de las baterías.
2. Saca las baterías incluidas.
3. Retira el plástico protector de las baterías.
4. Inserta las baterías tal y como se muestra.
5. Cierra la tapa del compartimento.

2. ENCENDIDO DEL BOOMBOX

En modo reposo, pulsa el botón de encendido para encender el boombox.



Consejo: mantén pulsado el botón de encendido durante 3 segundos para apagar las luces alrededor de los altavoces.

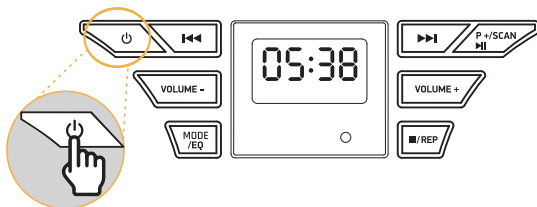

El KLIM Boombox posee un sistema de carga de baterías que se pone en marcha cuando el dispositivo se conecta a la corriente usando el cable de corriente. Si tienes intención de usar el Boombox durante mucho tiempo conectado a una toma de corriente principalmente, recomendamos retirar las baterías recargables para su mejor conservación.

MODOS CD Y BLUETOOTH

REPRODUCCIÓN DE CD

CD
MODE

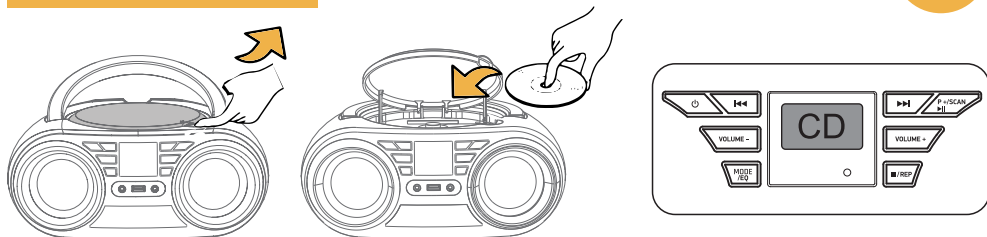

Paso 1: abre el compartimento de CD.

Paso 2: coloca dentro el CD y cierra el compartimento.

Paso 3: presiona MODE y selecciona el modo de CD.

Paso 4: presiona PLAY/PAUSE para reproducir el CD.



Presiona una vez para ir a la pista anterior/siguiente.



Mantén pulsado unos segundos para adelantar o rebobinar la pista actual.



Mientras se esté reproduciendo la pista, presiona una vez para repetirla (ONE). Presiona otra vez para repetir la lista de reproducción (ALL). Presiona otra vez para cancelar la repetición (OFF). Mantén pulsado para detener del todo la reproducción.

MODO BLUETOOTH



Paso 1: activa el Bluetooth en tu teléfono o tablet.

Paso 3: busca «KLIM Boombox B3» entre la lista de dispositivos disponibles y selecciónalo para sincronizarlo con el boombox.

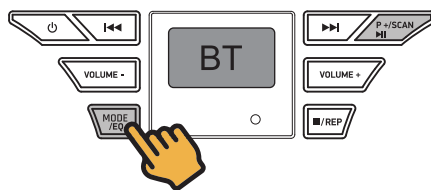

Paso 2: pulsa MODE y selecciona el modo BT.

Paso 4: presiona el botón PLAY/PAUSE para reproducir o pausar la pista seleccionada. Presiona y mantén pulsado para desconectar el dispositivo.



Dependiendo del dispositivo conectado puede que algunas opciones de reproducción como el avance rápido o el rebobinado no funcionen.

RADIO Y ENTRADA AUXILIAR



REPRODUCCIÓN DE RADIO

Paso 1: presiona el botón MODE y selecciona RAD; extiende la antena FM para mejorar la recepción de la señal de radio.

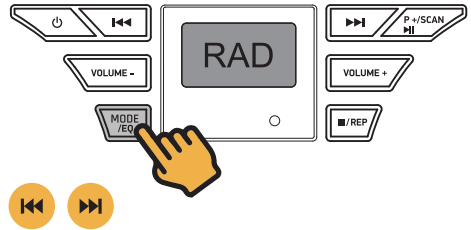

Paso 2: mantén pulsado el botón PREV o el botón NEXT para ir a la anterior o siguiente emisora disponible respectivamente. Presiona brevemente para seleccionar la frecuencia de forma manual.

CONFIGURACIÓN DE LAS PRESINTONÍAS (AUTOMÁTICA)



Mantén pulsado el botón PLAY/PAUSE para escanear automáticamente las frecuencias FM disponibles. Todas las frecuencias detectadas se guardarán en las presintonías P01 a P20. Una vez termine de guardarlas, pulsa brevemente el botón PLAY/PAUSE para cambiar a la siguiente presintonía.

CONFIGURACIÓN DE LAS PRESINTONÍAS (MANUAL)



Paso 1: utiliza estos botones para seleccionar la frecuencia deseada, tal y como se explica más arriba.



Paso 2: presiona brevemente el botón REP para acceder al modo memoria. Cuando se encienda el texto de la pantalla, espera 2 segundos y a continuación vuelve a presionar el botón para guardar dicha frecuencia como presintonía (por ejemplo, 105.3 en P01). Nota: puedes pulsar el botón PLAY/PAUSE mientras los números parpadean para seleccionar en qué presintonía quieres guardar la emisora.



Paso 3: presiona brevemente el botón PLAY/PAUSE para seleccionar una emisora FM presintonizada. Sigue pulsando brevemente para pasar a las siguientes (de P01 a P20).

PUERTO AUXILIAR (ENTRADA)

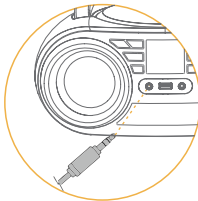

Paso 1: conecta un cable de audio de 3,5 mm (no incluido) al puerto AUX del KLIM Boombox.

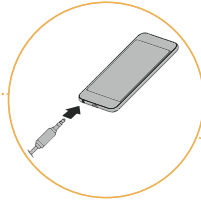

Paso 2: Conecta el otro extremo al puerto de tu dispositivo externo (por ejemplo, un MP3)

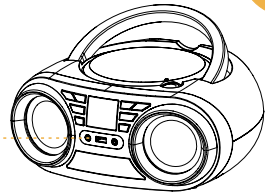

Paso 3: Presiona el botón MODE para seleccionar el modo AUX. El audio que se reproduzca en el dispositivo conectado sonará ahora a través del boombox.

AURICULARES Y MODO USB

PUERTO AUXILIAR (SALIDA)

Utiliza este puerto para conectar unos auriculares externos al boombox. Enchufa el jack de 3,5 mm al puerto AUX ubicado a la derecha y podrás disfrutar de la música a través de los auriculares. También podrás utilizar este puerto auxiliar para conectar el boombox a otros dispositivos compatibles con un jack 3,5 mm.

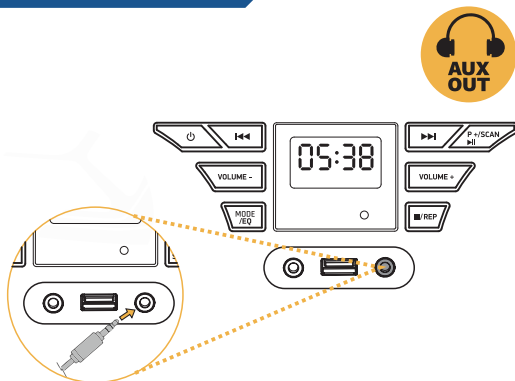

REPRODUCCIÓN DE USB

Presiona el botón EQ/MODE para seleccionar el modo USB y conecta tu memoria USB. El KLIM Boombox es compatible con formatos de audio MP3 y WMA.

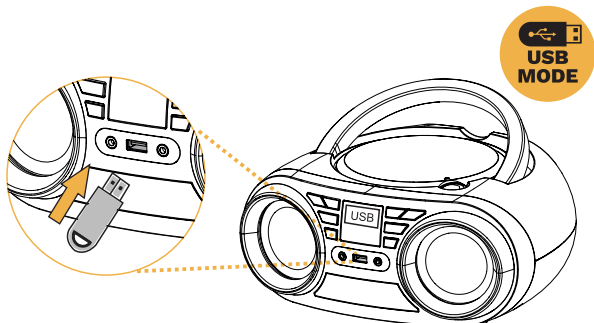

  Presiona una vez para ir a la pista anterior/siguiente.

Mantén pulsado para adelantar o rebobinar la pista actual.

 Mientras se esté reproduciendo la pista, presiona una vez para repetirla. Presiona otra vez para repetir la lista de reproducción. Presiona otra vez para cancelar el modo de repetición. Mantén pulsado para detener del todo la reproducción.



En cualquier modo de reproducción, presiona y mantén pulsado el botón EQ/MODE para ajustar el ecualizador (FLAT / CLASSICAL / JAZZ / ROCK / POP)

CONTACTO Y RESOLUCIÓN DE PROBLEMAS



Si tienes algún problema con este aparato o cualquiera de nuestros productos, recuerda que estamos a tu disposición para resolver cualquier incidencia. Escríbenos a espana@klimtechnologies.com para recibir asistencia. Nuestros especialistas siempre responden en menos de 24 horas. Y no olvides que el KLIM Boombox está cubierto por una garantía de 5 años.



WWW.KLIMTECHS.COM

Marcus Excelsior Limited
2512 Langham Place Office Tower
8 Argyle Street, Mongkok, Kowloon
Hong Kong

Authorised UK representative
Marcus Excelsior LLP
71-75, Shelton Street, Covent Garden,
London, WC2H 9JQ, England

Authorised EU representative
Marcus Excelsior Limited
Bracken Road No 51, Carlisle Offices
D18CV48 Dublin, Sandyford
Dublin, Ireland

