



KLIM BOOMBOX B4

USER MANUAL - MANUEL D'UTILISATION
BENUTZERHANDBUCH - MANUALE - MANUAL

INDEX

ENGLISH

Safety warnings	2
Controls and features	3
First use	4
CD & Bluetooth modes	5
Radio & AUX input	6
Headphones & USB modes	7
Remote control	8

FRANÇAIS

Consignes de sécurité	9
Commandes et caractéristiques	10
Première utilisation	11
Modes CD et Bluetooth	12
Radio et entrée auxiliaire	13
Casque et mode USB	14
Télécommande	15

DEUTSCH

Sicherheitshinweise	16
Steuerungen und Eigenschaften	17
Vor dem ersten Gebrauch	18
CD und Bluetooth	19
Radio und Aux-Eingang	20
Kopfhörer und USB-modus	21
Fernbedienung	22

ITALIANO

Avvertenze di sicurezza	23
Comandi e caratteristiche	24
Primo utilizzo	25
Modalità CD e bluetooth	26
Radio e ingresso AUX	27
Headphones & USB modes	28
Telecomando	29

ESPAÑOL

Advertencias de seguridad	30
Controles y especificaciones	31
Puesta en marcha	32
Modos CD y Bluetooth	33
Radio y entrada auxiliar	34
Auriculares y modo USB	35
Mando a distancia	36

SAFETY WARNINGS



Do not block the air vent to allow enough ventilation and prevent the unit from overheating. Do not expose this unit to rain, moisture, or humid environments, to prevent fire or shock hazards. This product contains batteries and electronic components. Please follow your local regulations in regards to the disposal of this type of device. Do not place any objects on top of the unit especially if they contain liquids (such as a glass with water). Exposure to loud sounds may cause hearing loss. Keep the volume within a reasonable level and do not place the speakers too close to your ears.



This symbol indicates that dangerous voltage constituting a risk of electric shock is present within this unit. CAUTION: to prevent electric shock, carefully insert the plug correctly into a matching socket or adapter of suitable voltage.



This product utilizes a Class 1 laser to read Compact Discs. Invisible laser radiation is present when the CD player is open, and the system's interlock has failed or has been damaged. Avoid direct exposure to the laser beam at all times.



This unit is equipped with a built-in lithium battery. Do not expose the unit to excessively high temperatures or direct sunlight for long periods of time as it may cause the battery to overheat and provoke a fire. Do not try to access the battery. Do not pierce the battery to avoid risk of explosion or fire.







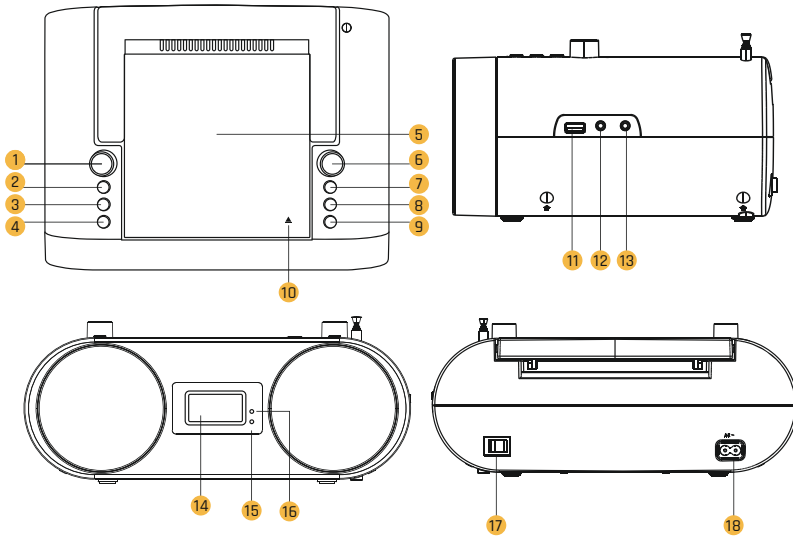





Any repairs on this device must be made only by experienced and qualified personnel. Any damage done to the unit while attempting a repair will void the warranty. If you face any issues with the device, please contact the manufacturer directly. We are at your disposal every day and our specialists always reply within 24 hours. Remember that your KLIM Boombox B4 is covered by a dependable 5-year warranty.

CONTROLS AND FEATURES



- | | | |
|--------------------------------------|--------------------------------|------------------------------|
| 1. POWER / Equalizer / Volume | 7. Mode | 13. Headphone jack |
| 2. Previous Track | 8. Repeat/Shuffle | 14. Display |
| 3. Next Track | 9. Stop | 15. Signal indicator |
| 4. Play/Pause | 10. Open/close CD comp. | 16. Battery indicator |
| 5. CD compartment | 11. USB Port | 17. Main switch |
| 6. Tuning knob / Sleep mode | 12. Aux In | 18. Power socket |

FEATURES

	Compatible with USB drives containing MP3/WMA files		EQ intelligent digital sound switching
	Supports CD-Audio, CD-R, CD-RW playback		Input and output auxiliary ports for 3.5 mm jacks
	Built-in FM-AM radio function with adjustable frequency band		Includes convenient remote controller with 2x AAA batteries
	Compatible with Bluetooth-enabled devices (BT 5.0)		Built-in rechargeable 18650 battery (2000 mAh)
	LCD display and electronic digital volume control		Includes battery recharge and circuit protection

FIRST USE

1. POWER UP

1. Plug the main power cord to a standard AC socket (100-240 V - 50/60 Hz).
2. Turn on the main switch.

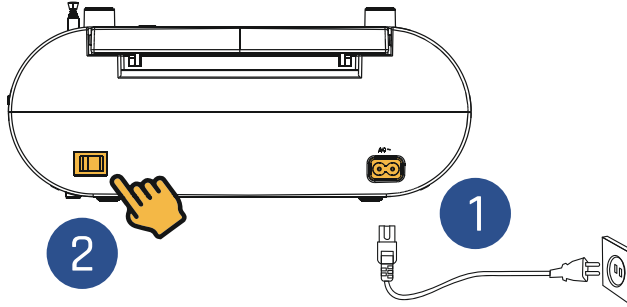

2. TURN ON THE BOOMBOX

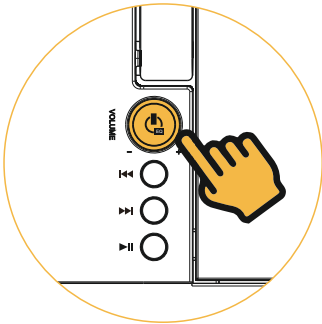

The KLIM Boombox has a battery recharging system that recharges the batteries when plugged in using the AC cord. **CAUTION:** The battery is not removable. If you don't intend to use the device for long periods of time, turn off the main switch at the back and unplug the power cord.

Press down and hold the left knob for 3 seconds to turn the Boombox on. Repeat this step to turn it off.

RECHARGEABLE BATTERY

You can use the Boombox while unplugged as long as the battery has sufficient charge. Make sure that the main switch at the back is in the ON position.

Charging indicators:

The screen displays the message LO when the battery is low.

The power light turns red while charging

The power light turns blue when fully charged.

CD & BLUETOOTH MODES

USING THE CD PLAYER

CD
MODE

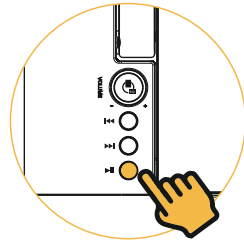
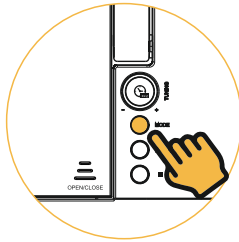
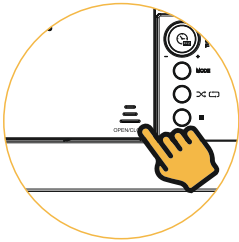

Step 1: Open the CD compartment.

Step 2: Place the CD inside and close the compartment.

MODE **Step 3:** Press MODE and select CD mode.

▶|| **Step 4:** Press PLAY/PAUSE button to play the loaded CD.



Press once to go to the previous/next track.



Press and hold to fast-forward or rewind the current track.



While playing a track, press once for single-track repeat. Press again for playlist repeat (ALL). Press again for random playback (RAND). Press again to cancel this function.

BLUETOOTH MODE

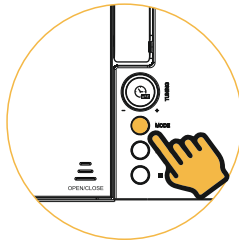

Step 1: Activate Bluetooth on your phone or tablet.

MODE **Step 2:** Press MODE and select BT mode.

Step 3: Find "KLIM Boombox B4" in the available devices list and select it to pair with the boombox.

▶|| **Step 4:** Press the PLAY/PAUSE button to play or pause the current track. Press and hold to disconnect the paired device.



Some playback features such as fast-forward or rewind may not function, depending on the connected device.

RADIO & AUX INPUT

USING THE RADIO

Step 1: Press the MODE button and select FM or AM, then extend the antenna to improve radio reception.

Step 2: Press the PREV or NEXT buttons to jump to the previous or next available station. Use the tuning knob to manually select the frequency.

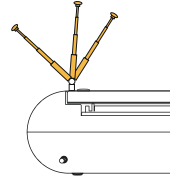
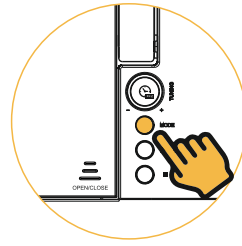

SETTING RADIO STATION PRESETS



Press and hold the PLAY/PAUSE button to auto-scan available FM frequencies. All detected frequencies will be saved to presets P01 to P20. Once the auto-scan has finished, press the NEXT/PREV button to select the desired preset.

AUXILIARY PORT (IN)

KLIM BOOMBOX B4

EXTERNAL DEVICES

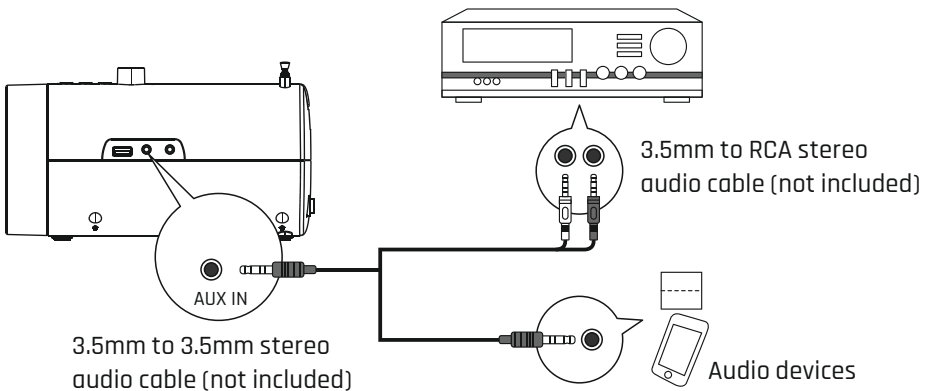

Step 1: Connect a 3.5 mm cable (not included) to the AUX port on the KLIM Boombox.

Step 2: Connect the other end to the output auxiliary port on your device (such as an Mp3 player)

Step 3: Press the MODE button to select AUX mode. Audio played through the connected device will now sound through the Boombox.

HEADPHONES & USB MODES

AUXILIARY PORT (OUT)

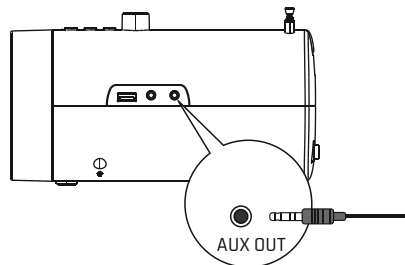

Use this port to connect external earphones to the Boombox. Simply plug in the 3.5 mm jack to the AUX port on the right and the sound will play through the connected earphones. You may also use this auxiliary output port to connect the Boombox to other compatible devices with a 3.5 mm jack.

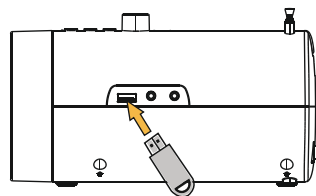

USB PLAYBACK

Plug in a USB flash drive with your music selection in the USB port. The device switches to USB mode automatically. You can also press the MODE button to select it manually. The KLIM Boombox B4 is compatible with Mp3 and WMA audio file formats. Max. USB drive capacity: 64 Gb



  Press once to go to the next or previous track. Press and hold to fast-forward or rewind the current track.



While playing a track, press once for single-track repeat. Press again for playlist repeat (ALL). Press again for random playback (RAND). Press again to cancel this function.



On any playback mode, briefly press the left knob (EQ) to change the equalization settings: FLAT / CLASSICAL / JAZZ / ROCK / POP

TIMED SLEEP MODE

You can set a timer to automatically switch off the Boombox after a fixed period of time elapses. Press the right knob downwards to set the timer to 15-30-45-60-90 minutes. Right after setting the time, the screen briefly displays the active setting with the text SL (SL15 = Boombox turns off after 15 minutes). You may cancel this function by pressing the knob until the text OFF is displayed.

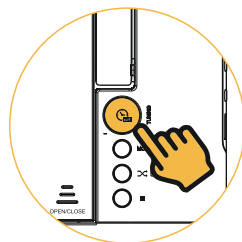

REMOTE CONTROL

BATTERY INSTALLATION

Insert the included AAA batteries in the compartment.

CAUTION: Ensure that the polarity is correct. Do not mix different types of batteries. Failure to follow these precautions can result in fire hazard.

Once used up, please dispose of the batteries properly according to your country's legislation.

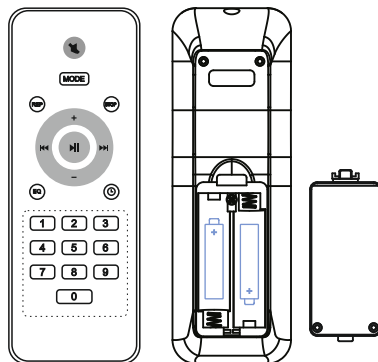

USING THE REMOTE

Press the buttons on the remote to execute the same functions as if you were pressing the buttons on the Boombox. Please refer to the relevant section in the previous pages to find out more about how to use them.

Press the  button at the top to mute/unmute the boombox in any play mode.

The numeric buttons at the bottom of the remote let you skip to specific track numbers while in CD/USB mode. While FM/AM mode is active, you can also change the radio frequency by pressing the numbers on the remote.

Note: while the Boombox is connected to an external device via the AUX port, the remote control functions are limited to volume up/down and mute.

SPECIFICATIONS

AC voltage: 110-240 V 50/60 Hz

Battery capacity: 2000 mAh

Speaker power: 1.5 W x 2 (total 3 W)

Speaker signal: stereo

CONTACT AND TROUBLESHOOTING



If you ever encounter any trouble with this device or any of our products, remember that we are at your disposal and ready to help you with any issue. Contact us at support@klimtechnologies.com for assistance. Our specialists always reply within 24 hours. And don't forget that the KLIM Boombox is covered by a dependable 5-year warranty.

CONSIGNES DE SÉCURITÉ



Ne bloquez pas les aérations ce afin d'empêcher l'appareil de surchauffer.

Ce produit contient une batterie et des composants électroniques. Veuillez suivre la législation locale en vigueur concernant le recyclage de ce type d'appareil.

Ne placez aucun objet sur l'appareil, en particulier s'il contient un liquide (comme un verre d'eau).

Une exposition prolongée à un volume élevé peut causer des pertes d'audition. Gardez le volume à un niveau raisonnable et ne placez pas les haut-parleurs trop près de vos oreilles.



Ce symbole indique que cet appareil fonctionne sous une tension qui peut être dangereuse et entraîner une électrocution. ATTENTION : pour éviter tout risque d'électrocution, insérez soigneusement la fiche dans une prise ou un adaptateur ayant une tension appropriée.



Ce produit utilise un laser de classe 1 pour lire les disques compacts. Un rayonnement laser invisible est présent lorsque le lecteur de CD est ouvert et que le verrouillage du système ne fonctionne pas ou a été endommagé. Évitez à tout moment l'exposition directe avec ce laser.



Cet appareil est équipé d'une batterie lithium intégrée. N'exposez pas l'appareil à des températures excessivement élevées ou à la lumière du soleil pour de longues périodes, au risque de provoquer la surchauffe de la batterie ou un départ de feu. N'essayez pas d'accéder à la batterie. Ne percez pas la batterie pour éviter tout risque d'explosion ou de feu.







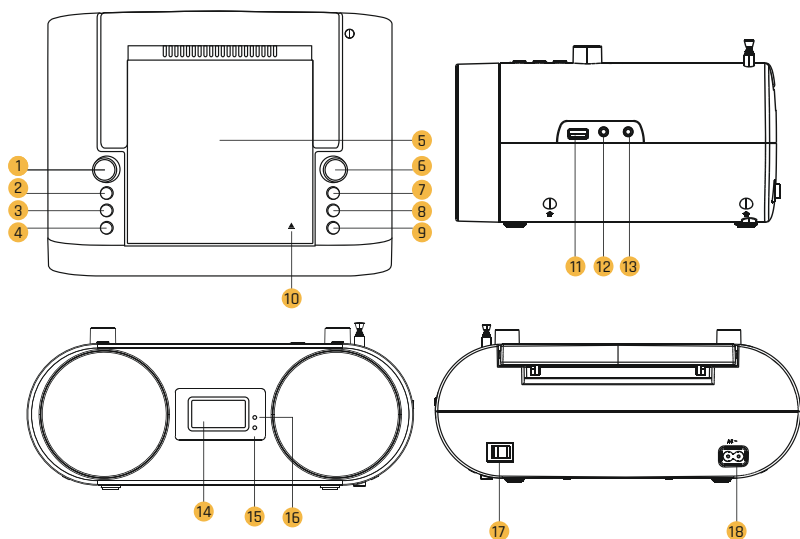





Toutes les réparations sur cet appareil doivent être faites par du personnel expérimenté et qualifié. Tout dommage causé à l'appareil lors d'une tentative de réparation annulera automatiquement la garantie. Si vous rencontrez des problèmes avec l'appareil, veuillez contacter directement le fabricant. Nous sommes à votre disposition tous les jours et nos spécialistes vous répondent toujours dans les 24 heures. N'oubliez pas que votre KLIM Boombox est couverte par une garantie de 5 ans.

COMMANDES ET CARACTÉRISTIQUES



- | | | |
|-----------------------------------|---------------------------------|----------------------------|
| 1. POWER / EQ / Volume | 7. Mode | 13. Port jack pour casque |
| 2. Piste précédente | 8. Répéter/Lecture aléatoire | 14. Affichage |
| 3. Piste suivante | 9. Stop | 15. Indicateur de signal |
| 4. Lecture/Pause | 10. Ouvrir/fermer le comp. à CD | 16. Indicateur de batterie |
| 5. Compartiment à CD | 11. Port USB | 17. Bouton d'alimentation |
| 6. Molette de fréq. / Mode veille | 12. Aux In | 18. Prise d'alimentation |

CARACTÉRISTIQUES

	Compatible avec les clés USB contenant des fichiers MP3/WMA		Egaliseur Numérique 5 modes
	Supporte les CD-Audio, CD-R. Lecture de CD-RW		Ports audio stéréo AUX-in et AUX-out avec prise jack
	Fonction radio FM-AM intégrée avec bande de fréquence réglable		Inclut une télécommande ergonomique avec x2 piles AAA
	Compatible avec les appareils Bluetooth (BT 5.0)		Batterie 18650 rechargeable intégrée (2000 mAh)
	Écran LCD et contrôle électronique du volume numérique		Recharge de la batterie et protection du circuit incluses

PREMIÈRE UTILISATION

1. MISE EN MARCHÉ

1. Branchez le cordon d'alimentation sur une prise de courant alternatif standard (100-240V - 50/60 Hz)
2. Appuyez sur le bouton d'alimentation à l'arrière de la Boombox.

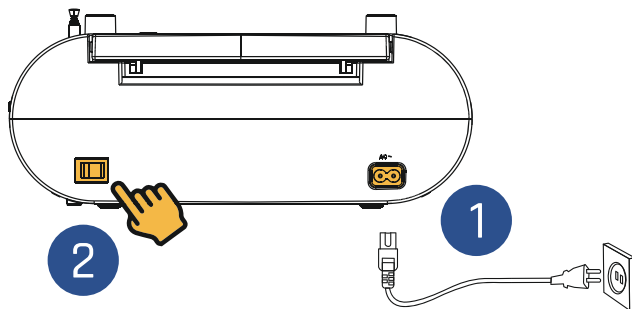

2. ALLUMEZ LA BOOMBOX

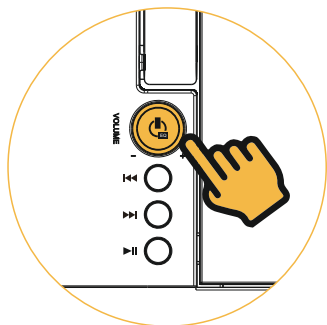

La KLIM Boombox est équipée d'une batterie qui se recharge lorsque vous la branchez sur secteur. **ATTENTION** : La batterie n'est pas démontable. Si vous n'avez pas l'intention d'utiliser l'appareil pendant une longue période, éteignez l'interrupteur principal à l'arrière et débranchez le câble d'alimentation.

Appuyez sur le bouton POWER/EQ et maintenez-le enfoncé pendant 3 secondes pour allumer la Boombox. Répétez cette opération pour l'éteindre.

BATTERIE RECHARGEABLE

Vous pouvez utiliser la Boombox lorsqu'elle est débranchée, tant que la batterie est suffisamment chargée.

Assurez-vous que l'interrupteur principal à l'arrière est en position ON.

Indicateurs de charge :

L'écran affiche le message LO lorsque la batterie est faible.

Le voyant d'alimentation devient rouge pendant la charge.

Le voyant d'alimentation devient bleu lorsque la batterie est complètement chargée.

MODES CD ET BLUETOOTH

UTILISATION DU LECTEUR CD

CD
MODE

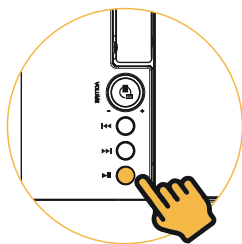
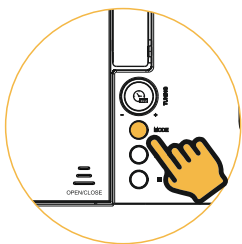
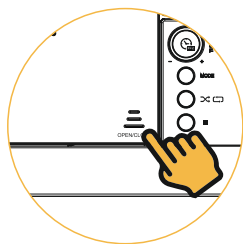

Étape 1 : Ouvrez le compartiment de CD.

Étape 2 : Placez le CD à l'intérieur puis refermez le compartiment.

MODE Étape 3 : Appuyez sur MODE et sélectionnez le mode CD.

▶|| Étape 4 : Appuyez sur PLAY/PAUSE pour lire le CD chargé.



Appuyez une fois pour passer à la piste précédente/suivante.

Maintenez cette touche appuyée pour faire une avance rapide ou un retour en arrière sur la piste en cours.



Pendant la lecture d'une piste, appuyez une fois sur cette touche pour répéter la piste en question. Appuyez à nouveau sur cette touche pour répéter la liste de lecture entière (ALL). Appuyez à nouveau pour une lecture aléatoire (RAND). Appuyez à nouveau sur cette touche pour annuler cette fonction.

MODE BLUETOOTH

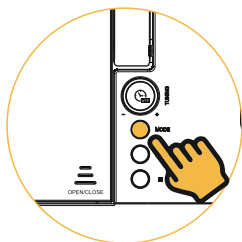

Étape 1 : Activez le Bluetooth sur votre téléphone ou votre tablette.

Étape 3 : Trouvez « KLIM Boombox B4 » dans la liste des appareils disponibles et sélectionnez-le pour le coupler avec la Boombox.

MODE Étape 2 : Appuyez sur MODE et sélectionnez le mode BT.

▶|| Étape 4 : Appuyez sur le bouton PLAY/PAUSE pour lire ou mettre en pause la piste en cours. Maintenez la touche appuyée pour déconnecter le dispositif couplé.



Certaines fonctions de lecture telles que l'avance ou le retour rapide peuvent ne pas fonctionner, selon l'appareil connecté.

RADIO ET ENTRÉE AUXILIAIRE

UTILISATION DE LA RADIO

Étape 1 : Appuyez sur la touche MODE et sélectionnez FM ou AM, puis déployez l'antenne pour améliorer la réception du signal radio.

Étape 2 : Appuyez sur les boutons PREV ou NEXT pour passer à la station disponible précédente ou suivante. Utilisez la molette de réglage pour sélectionner manuellement la fréquence.

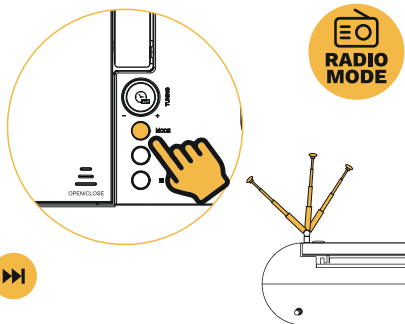

RÉGLAGE DES PRÉSÉLECTIONS DES STATIONS DE RADIO



Pressez et maintenez la touche PLAY/PAUSE pour balayer automatiquement les fréquences FM disponibles. Toutes les fréquences détectées seront enregistrées dans les préréglages P01 à P20. Une fois le balayage automatique terminé, appuyez sur le bouton NEXT/PREV pour sélectionner le préréglage souhaité.

PORT AUXILIAIRE (IN)



APPAREILS EXTERNES

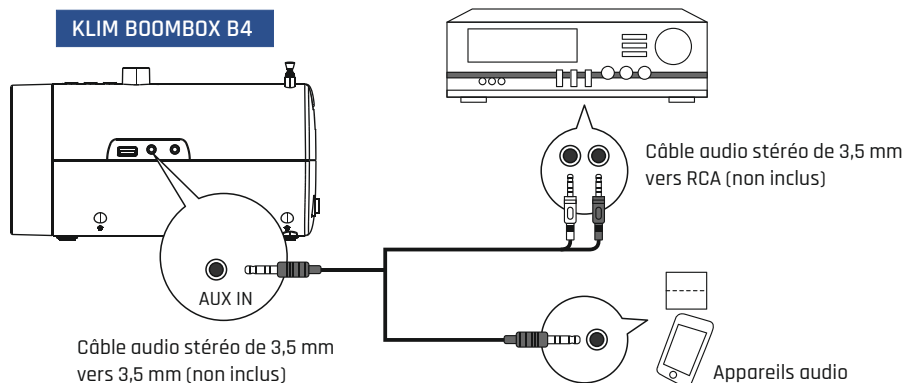

Étape 1 : Connectez un câble de 3,5 mm (non fourni) au port AUX de la KLIM Boombox.

Étape 2 : Connectez l'autre extrémité au port auxiliaire de sortie de votre appareil (comme un lecteur MP3).

Étape 3 : Appuyez sur la touche MODE pour sélectionner le mode AUX. Le son diffusé par l'appareil connecté sortira maintenant sur la Boombox.

PORT AUXILIAIRE (OUT)

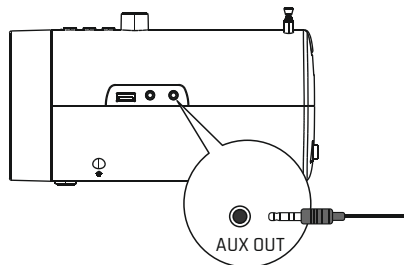

Utilisez ce port pour connecter des écouteurs externes à la Boombox. Il suffit de brancher la prise jack de 3,5 mm au port AUX de droite et le son sera diffusé par les écouteurs connectés. Vous pouvez également utiliser ce port de sortie auxiliaire pour connecter la Boombox à d'autres appareils compatibles avec une prise jack de 3,5 mm.

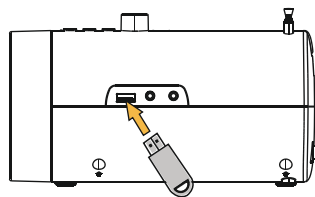

LECTURE USB

Branchez une clé USB avec votre liste de musiques dans le port correspondant. L'appareil passe automatiquement en mode USB. Vous pouvez également appuyer sur le bouton MODE pour le sélectionner manuellement. La KLIM Boombox est compatible avec les formats de fichiers audio MP3 et WMA. Capacité max. de stockage de la clé USB : 64 Gb



  Appuyez une fois pour passer à la piste suivante ou précédente. Maintenez cette touche appuyée pour faire une avance rapide ou un retour en arrière sur la piste en cours.



Pendant la lecture d'une piste, appuyez une fois pour répéter une piste. Appuyez à nouveau sur cette touche pour répéter la liste de lecture. Appuyez à nouveau sur cette touche pour annuler cette fonction. Maintenez cette touche appuyée pour arrêter complètement la lecture.



Dans n'importe quel mode de lecture, appuyez brièvement sur la molette de gauche (EQ) pour modifier les paramètres de l'égaliseur : FLAT/CLASSICAL/JAZZ/ROCK/POP

MODE VEILLE PROGRAMMÉE

Vous pouvez régler une minuterie pour que la Boombox s'éteigne automatiquement au bout d'une certaine période de temps. Poussez la molette de droite vers le bas pour régler la minuterie sur 15-30-45-60-90 minutes. Juste après avoir réglé l'heure, l'écran affiche brièvement le réglage actif avec le message SL (SL15 = la Boombox s'éteint après 15 minutes). Vous pouvez annuler cette fonction en appuyant sur la molette jusqu'à ce que le message OFF s'affiche.

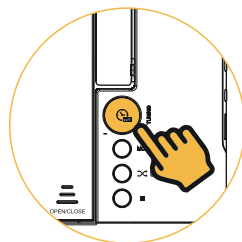

INSTALLATION DES PILES

Insérez les piles AAA fournies dans le compartiment.

ATTENTION : Veuillez à respecter la polarité. Ne mélangez pas différents types de piles. Le non-respect de ces précautions peut entraîner un risque d'incendie.

Une fois les piles vides, veuillez disposer des piles de manière appropriée, conformément à la législation de votre pays.

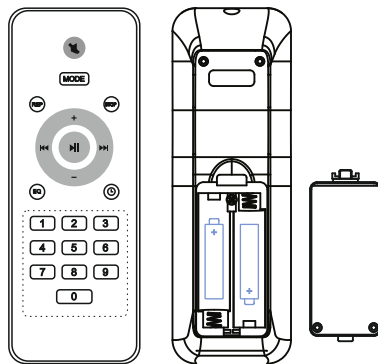

UTILISATION DE LA TÉLÉCOMMANDE

Appuyez sur les boutons de la télécommande pour exécuter les mêmes fonctions que si vous appuyiez sur les boutons de la Boombox. Veuillez vous reporter à la section correspondante dans les pages précédentes pour en savoir plus sur la façon de les utiliser.

Appuyez sur le bouton  en haut pour couper/rétablir le son de la Boombox dans n'importe quel mode de lecture.

Les boutons numériques situés en bas de la télécommande vous permettent de sélectionner des pistes spécifiques en mode CD/USB. Lorsque le mode FM/AM est actif, vous pouvez également changer la fréquence radio en appuyant sur les boutons numériques de la télécommande.

Remarque : lorsque la Boombox est connectée à un appareil externe via le port AUX, les fonctions de la télécommande se limitent au volume haut/bas et à la coupure du son.

SPÉCIFICATIONS

Tension AC : 110-240v 50/60 Hz

Capacité de la batterie : 2000 mAh

Puissance du haut-parleur : 1,5 W x 2 (total 3 W)

Signal du haut-parleur : stéréo

CONTACT ET DÉPANNAGE



Si jamais vous rencontrez un problème avec cet appareil ou l'un de nos produits, n'oubliez pas que nous sommes à votre disposition et prêts à vous aider pour toute question. Contactez-nous à l'adresse france@klimtechnologies.com pour obtenir de l'aide. Nos spécialistes vous répondront toujours dans les 24 heures. Enfin, n'oubliez pas que la KLIM Boombox est couverte par une garantie fiable de 5 ans.



Blockiere nicht die Lüftungsöffnung, um eine ausreichende Belüftung zu gewährleisten und eine Überhitzung des Geräts zu verhindern.

Dieses Produkt enthält Batterien und elektronische Komponenten. Bitte befolge die örtlichen Vorschriften für die Entsorgung dieser Art von Geräten.

Stelle keine Gegenstände auf das Gerät, insbesondere wenn sie Flüssigkeiten enthalten (z.B. ein Glas mit Wasser).

Die Exposition gegenüber lauten Geräuschen kann zu Hörverlust führen. Halte die Lautstärke innerhalb eines vernünftigen Rahmens und platziere die Lautsprecher nicht zu nah an deinen Ohren.



Dieses Symbol weist darauf hin, dass eine gefährliche Spannung an diesem Gerät anliegt, die die Gefahr eines elektrischen Schlags mit sich bringt. **ACHTUNG:** Um einen elektrischen Schlag zu vermeiden, den Stecker vorsichtig und korrekt in eine passende Steckdose oder einen geeigneten Spannungsadapter stecken.



Dieses Produkt verwendet einen Laser der Klasse 1 zum Lesen von CDs. Wenn der CD-Player geöffnet ist und die Verriegelung des Systems ausgefallen oder beschädigt ist, gibt es unsichtbare Laserstrahlungen. Stets die direkte Einwirkung des Laserstrahls vermeiden.



Dieses Gerät ist mit einer eingebauten Lithium-Batterie ausgestattet. Setze das Gerät nicht über einen längeren Zeitraum zu hohen Temperaturen oder direktem Sonnenlicht aus, da dies zu einer Überhitzung der Batterie führen und einen Brand auslösen kann. Versuche nicht, auf die Batterie zuzugreifen. Steche nicht in die Batterie, um das Risiko einer Explosion oder eines Brandes zu vermeiden.







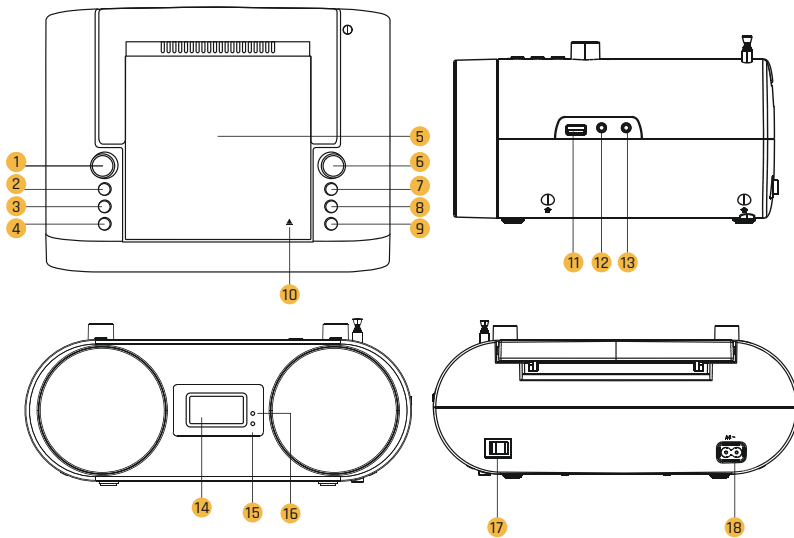





Reparaturen an diesem Gerät dürfen nur von erfahrenem und qualifiziertem Personal durchgeführt werden. Jegliche Beschädigung des Geräts beim Versuch einer Reparatur beendet die Garantie. Bei Problemen mit dem Gerät wende Dich bitte direkt an den Hersteller. Wir sind jeden Tag für Dich da und unsere Fachleute antworten immer innerhalb von 24 Stunden. Denke daran, dass Deine KLIM Boombox 5 Jahre Garantie hat.

STEUERUNGEN UND EIGENSCHAFTEN



- | | | |
|--|--------------------------------|-------------------------------|
| 1. POWER / Equalizer / Lautstärke | 7. Modus | 13. Kopfhöreranschluss |
| 2. Vorheriger Track | 8. Wiederholung/Shuffle | 14. Display |
| 3. Nächster Track | 9. Stop | 15. Signalanzeige |
| 4. Wiedergabe/Pause | 10. CD öffnen/schließen | 16. Akku-Anzeige |
| 5. CD-Fach | 11. USB-Anschluss | 17. Hauptschalter |
| 6. Tuning-Knopf/Sleep-Modus | 12. Aux-Eingang | 18. Netzstecker |

EIGENSCHAFTEN

	Kompatibel mit USB-Trägern, die MP3/WMA-Dateien enthalten		EQ intelligente digitale Klangumschaltung
	Unterstützt CD-Audio-, CD-R-, CD-RW-Wiedergabe		AUX-IN-Audioanschluss mit Stereo-Kopfhörerbuchse
	Eingebaute FM-AM Radiofunktion mit einstellbarem Frequenzband		Inklusive praktischer Fernbedienung mit 2x AAA-Batterien
	Kompatibel mit Bluetooth-fähigen Geräten (BT 5.0)		Eingebaute, wiederaufladbare 18650 Batterie (2000 mAh)
	LCD-Display und elektronische digitale Lautstärkeregelung		Mit Akkuaufladung und Stromkreisschutz

VOR DEM ERSTEN GEBRAUCH

1. STROMVERSORGUNG

1. Das Netzkabel an eine Standard-Wechselstromsteckdose (100-240 V - 50/60 Hz) anschließen
2. Schalte den Hauptschalter auf der Rückseite der Boombox ein.

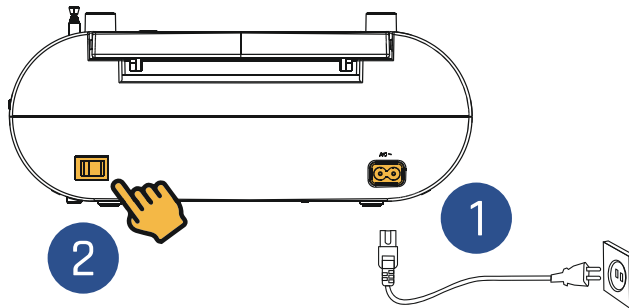

2. DIE BOOMBOX ANSTELLEN

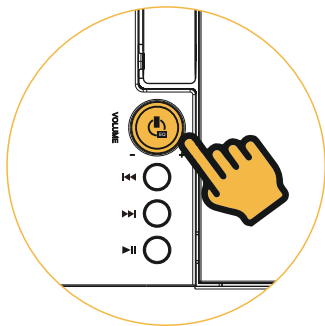

Die KLIM Boombox verfügt über ein Akkuladesystem, das die Batterien wieder auflädt, wenn sie über das Netzkabel angeschlossen ist. **ACHTUNG:** Der Akku ist nicht herausnehmbar. Wenn du das Gerät für längere Zeit nicht benutzen willst, schalte den Hauptschalter auf der Rückseite aus und ziehe das Netzkabel ab.

Drücke den POWER/EQ-Knopf und halte ihn für 3 Sekunden gedrückt, um die Boombox einzuschalten. Wiederhole diesen Schritt, um sie auszuschalten.

AUFLADBARE BATTERIE

Du kannst die Boombox im ausgesteckten Zustand benutzen, solange der Akku ausreichend geladen ist. Achte darauf, dass der Hauptschalter auf der Rückseite in der Position ON steht.

Ladeindikatoren:

Der Bildschirm zeigt die Meldung LO an, wenn der Akku schwach ist.

Das Power-Licht leuchtet während des Ladevorgangs rot

Das Power-Licht leuchtet blau, wenn der Akku vollständig geladen ist.

BEDIENUNG DES CD-PLAYERS

CD
MODE

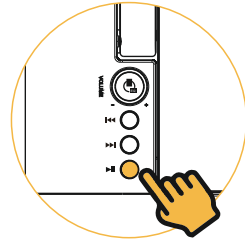
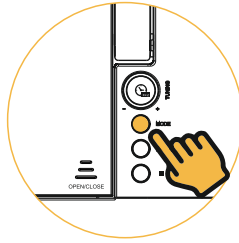
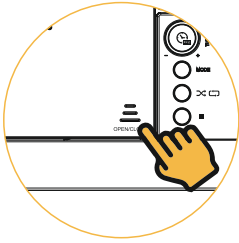

Schritt 1: CD-Fach öffnen.

Schritt 2: CD einlegen und das Fach schließen.

MODE Schritt 3: MODE drücken und den CD-Modus wählen.

▶|| Schritt 4: PLAY/PAUSE drücken, um die eingelegte CD abzuspielen.



Ein Mal drücken, um zum vorherigen/nächsten Titel zu wechseln.

Die Taste gedrückt halten, um den aktuellen Titel schnell vor- oder zurückzuspulen.



Drücke während der Wiedergabe eines Titels einmal für die Einzeltitelwiederholung. Drücke erneut für die Wiederholung der Wiedergabeliste (ALL). Drücke erneut für die Zufallswiedergabe (RAND). Drücke erneut, um diese Funktion abzubrechen.

BLUETOOTH-MODUS

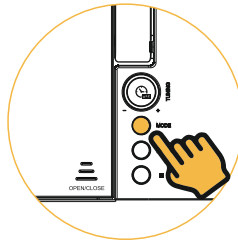

Schritt 1: Aktiviere das Bluetooth auf Deinem Handy oder Tablet.

Schritt 3: „KLIM Boombbox B4“ in der Liste der verfügbaren Geräte suchen und zum Koppeln mit der Boombbox auswählen.

MODE Schritt 2: MODE drücken und den BT-Modus wählen.

▶|| Schritt 4: Die PLAY/PAUSE-Taste drücken, um den aktuellen Titel abzuspielen oder anzuhalten. Die Taste gedrückt halten, um die Verbindung mit dem gekoppelten Gerät zu trennen.



Je nach angeschlossenem Gerät kann es sein, dass manche Wiedergabefunktionen wie schneller Vor- oder Rücklauf nicht funktionieren.

RADIO UND AUX-EINGANG

BEDIENUNG DES RADIOS

Schritt 1: Drücke die MODE-Taste und wähle FM oder AM, dann fahre die Antenne aus, um den Radioempfang zu verbessern.

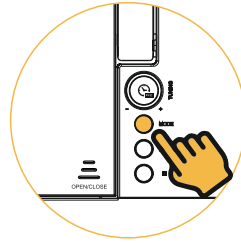

Step 2: Drücke die Tasten PREV oder NEXT, um zum vorherigen oder nächsten verfügbaren Sender zu springen. Benutze den Abstimmknopf, um die Frequenz manuell auszuwählen.

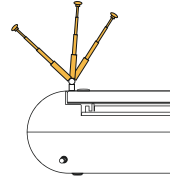

EINSTELLEN VON RADIOSENDER-VOREINSTELLUNGEN



Drücke und halte die PLAY/PAUSE Taste, um die verfügbaren FM-Frequenzen automatisch zu scannen. Alle gefundenen Frequenzen werden auf den Presets P01 bis P20 gespeichert. Sobald der Auto-Scan abgeschlossen ist, drücke die NEXT/PREV-Taste, um den gewünschten Preset auszuwählen.

HILFSANSCHLUSS (EINGANG)

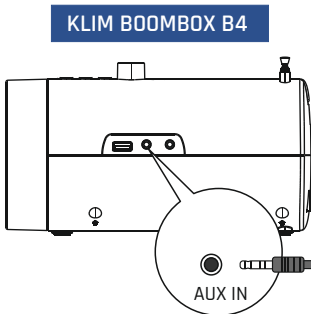

3,5-mm-auf-3,5-mm-Stereo-Audiokabel
(nicht im Lieferumfang enthalten)

EXTERNE GERÄTE

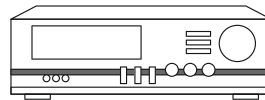

3,5mm auf RCA Stereo-Audiokabel
(nicht im Lieferumfang enthalten)

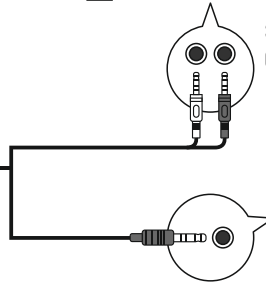

Audiogeräte

Schritt 1: Ein 3,5mm-Kabel (nicht im Lieferumfang enthalten) an den AUX-Anschluss der KLIM Boombox anschließen.

Schritt 2: Das andere Ende mit dem Hilfsausgang Ihres Geräts (z. B. einem MP3-Player) verbinden.

Schritt 3: Die MODE-Taste drücken und den AUX-Modus wählen. Der über das angeschlossene Gerät abgespielte Ton wird nun über die Boombox wiedergegeben.

KOPFHÖRER UND USB-MODUS



HILFSANSCHLUSS (AUSGANG)

Über diesen Anschluss können externe Kopfhörer an die Boombox angeschlossen werden. Einfach den 3,5mm-Klinkenstecker in den AUX-Anschluss auf der rechten Seite stecken, und der Ton wird über die angeschlossenen Kopfhörer wiedergegeben. Du kannst diesen Hilfsausgang auch verwenden, um die Boombox mit anderen kompatiblen Geräten mit einem 3,5mm-Stecker zu verbinden.

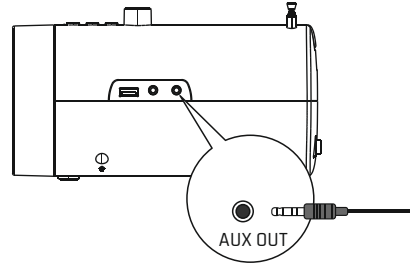

USB-WIEDERGABE

Stecke einen USB-Stick mit deiner Musikauswahl in den USB-Port. Das Gerät schaltet automatisch in den USB-Modus. Du kannst auch die MODE-Taste drücken, um ihn manuell auszuwählen. Die KLIM Boombox ist mit den Audiodateiformaten Mp3 und WMA kompatibel.

Max. USB-Laufwerkskapazität: 64 Gb

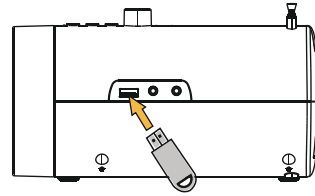

Während der Wiedergabe eines Titels ein Mal drücken, um einen Titel zu wiederholen. Erneut drücken, um die Wiedergabeliste zu wiederholen. Erneut drücken, um diese Funktion abzubrechen. Die Taste gedrückt halten, um die Wiedergabe vollständig zu stoppen.



Ein Mal drücken, um zum nächsten bzw. zum vorherigen Titel zu wechseln. Die Taste gedrückt halten, um den aktuellen Titel schnell vor- oder zurückzuspulen.



Drücke in jedem Wiedergabemodus kurz auf den linken Knopf (EQ), um die Equalizer-Einstellungen zu ändern: FLAT / CLASSICAL / JAZZ / ROCK / POP.

ZEITGESTEUERTER SCHLAFMODUS

Du kannst einen Timer einstellen, um die Boombox nach Ablauf einer bestimmten Zeit automatisch auszuschalten. Drücke den rechten Drehknopf nach unten, um den Timer auf 15-30-45-60-90 Minuten einzustellen. Direkt nach dem Einstellen der Zeit zeigt der Bildschirm kurz die aktive Einstellung mit dem Text SL an (SL15 = Boombox schaltet sich nach 15 Minuten aus). Du kannst diese Funktion abbrechen, indem du den Knopf drückst, bis der Text OFF angezeigt wird.

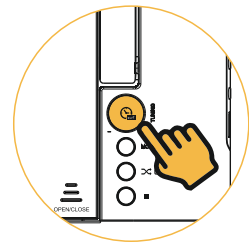

BATTERIEEINBAU

Lege die mitgelieferten AAA-Batterien in das Fach ein.

ACHTUNG: Achte auf die richtige Polarität. Mische nicht verschiedene Batterietypen. Die Nichtbeachtung dieser Vorsichtsmaßnahmen kann zu Brandgefahr führen.

Wenn die Batterien verbraucht sind, entsorge sie bitte ordnungsgemäß entsprechend der Gesetzgebung deines Landes.

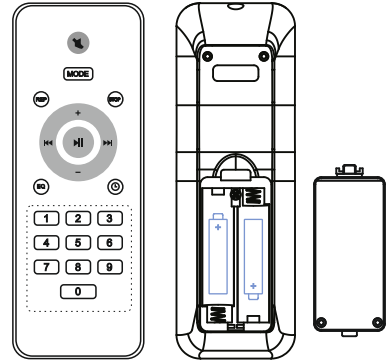

BENUTZUNG DER FERNBEDIENUNG

Drücke die Tasten auf der Fernbedienung, um die gleichen Funktionen auszuführen, als ob du die Tasten auf der Boombox drücken würdest. Lies bitte den entsprechenden Abschnitt auf den vorherigen Seiten, um mehr über deren Verwendung zu erfahren.

Drücke die  Taste oben, um die Boombox in jedem Wiedergabemodus stummzuschalten / aufzuheben.

Mit den Zifferntasten am unteren Rand der Fernbedienung kannst du im CD/USB-Modus zu bestimmten Titelnummern springen. Während der FM/AM-Modus aktiv ist, kannst du die Radiofrequenz auch durch Drücken der Zahlen auf der Fernbedienung ändern.

Hinweis: Während die Boombox über den AUX-Anschluss mit einem externen Gerät verbunden ist, sind die Fernbedienungsfunktionen auf Lautstärke hoch/runter und Stummschaltung beschränkt.

TECHNISCHE DATEN

Netzstrom-Spannung: 110-240 V 50/60 Hz

Akkukapazität: 2000 mAh

Leistung der Lautsprecher: 1,5 W x 2 (insgesamt 3 W)

Lautsprechersignal: Stereo

KONTAKT & FEHLERBEHEBUNG



Solltest du jemals Probleme mit diesem Gerät oder einem unserer Produkte haben, denke daran, dass wir dir zur Verfügung stehen und bereit sind, dir bei jedem Problem zu helfen. Kontaktiere uns unter deutschland@klimtechnologies.com für Hilfe. Unsere Spezialisten antworten immer innerhalb von 24 Stunden. Und vergiss nicht, dass die KLIM Boombox von einer zuverlässigen 5-Jahres-Garantie abgedeckt ist.



Non bloccare le prese d'aria per consentire una sufficiente ventilazione e prevenire il surriscaldamento dell'unità. Questo prodotto contiene batterie e componenti elettroniche. Gentilmente fai riferimento alle regolamentazioni locali in merito allo smaltimento di questo tipo di prodotto.

Non posizionare oggetti al di sopra dell'unità, soprattutto se essi contengono liquidi (ad esempio, un bicchiere d'acqua).

L'esposizione a suoni ad alto volume può causare perdita di udito. Mantieni il volume su livelli ragionevoli e non posizionare gli altoparlanti troppo vicini alle tue orecchie.



Questo simbolo indica la presenza di tensione pericolosa nell'unità e il conseguente rischio di scossa elettrica. **ATTENZIONE:** per evitare scosse elettriche, avere cura di inserire correttamente la spina in una presa compatibile o un adattatore della tensione adeguata.



Questo prodotto impiega un laser di Classe 1 per la lettura dei compact disc. È presente una radiazione laser invisibile quando il lettore CD è aperto e l'interblocco del sistema è guasto o ha subito dei danni. Evitare in ogni momento l'esposizione diretta al raggio laser.



Questa unità include una batteria al litio incorporata. Non esporre l'unità a temperature eccessivamente elevate o alla luce diretta del Sole in quanto questo potrebbe causare un surriscaldamento della batteria e provocare un incendio. Non accedere direttamente alla batteria. Non forare la batteria onde evitare rischio di esplosioni od incendi.







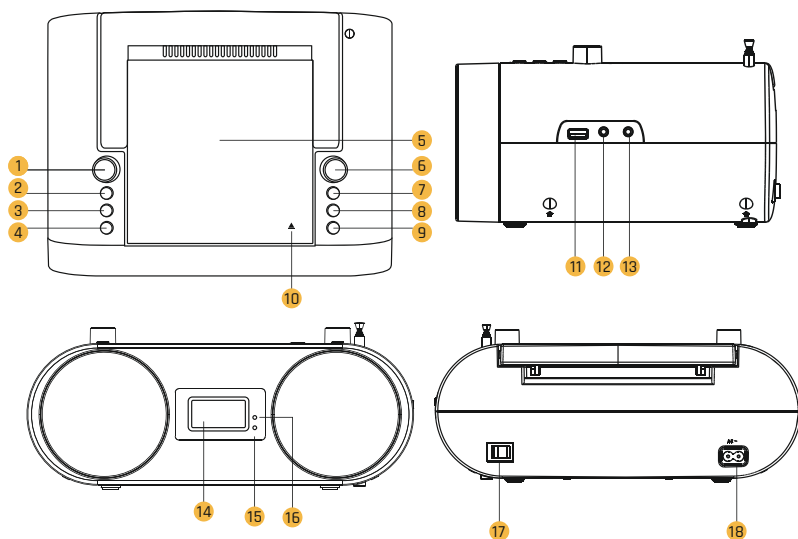





Qualsiasi intervento sul prodotto deve essere effettuato da personale competente e qualificato. Qualsiasi danno causato al prodotto durante un tentativo di riparazione invaliderà la garanzia. In caso di problemi con il dispositivo, rivolgersi direttamente al produttore. Siamo disponibili tutti i giorni e i nostri esperti sono pronti a rispondere 24 ore su 24. Si ricorda che il KLIM Boombox è coperto da un'affidabile garanzia di 5 anni.

COMANDI E CARATTERISTICHE



- | | | |
|-----------------------------|----------------------------------|------------------------------|
| 1. Accensione / EQ / Volume | 7. Modalità | 13. Ingresso auricolari jack |
| 2. Traccia Precedente | 8. Ripeti / Riproduzione casuale | 14. Display |
| 3. Traccia Successiva | 9. Stop | 15. Indicatore segnale |
| 4. Play / Pausa | 10. Apri / Chiudi comp. CD | 16. Indicatore batteria |
| 5. Compartimento CD | 11. Porta USB | 17. Interruttore principale |
| 6. Sintonizzazione / Sleep | 12. Ingresso (AUX) | 18. Presa elettrica |

CARATTERISTICHE

	Compatibile con unità USB contenenti file MP3/WMA		Modifica digitale del suono con EQ intelligente
	Riproduzione di supporti CD-Audio, CD-R, CD-RW		Ingresso ed uscita ausiliari stereo con jack 3.5 mm
	Include funzione radio AM-FM con bande di frequenza regolabili		Include un comodo telecomando con 2x batterie AAA
	Compatibile con dispositivi con funzione Bluetooth (BT 5.0)		Batteria 18650 integrata (2000 mAh)
	Display LCD e controllo digitale del volume		Include protezione del circuito e della ricarica delle batterie

PRIMO UTILIZZO

1. ALIMENTAZIONE

1. Inserire il cavo CA in una presa CA standard (100-240 V, 50/60 Hz)
2. Accendi l'interruttore principale sul retro dello stereo.

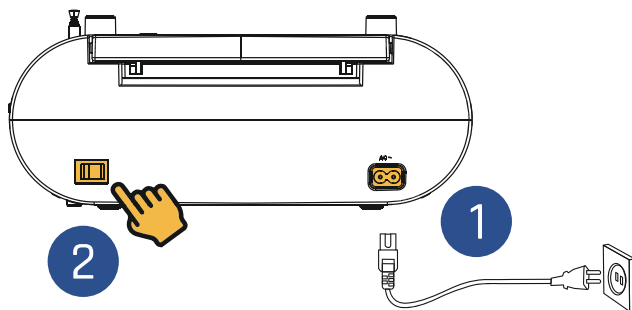

2. ACCENSIONE DEL BOOMBOX

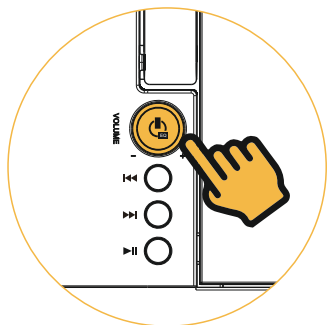

Il KLIM Boombox è dotato di un sistema che ricarica le batterie interne quando l'unità è collegata alla presa elettrica con il cavo di alimentazione. **ATTENZIONE:** La batteria non è rimovibile. Se intendi non utilizzare il dispositivo per periodi di tempo prolungati, spegni l'interruttore principale e scollega la presa elettrica.

Premi e tieni premuto sulla manopola Accensione / EQ per 3 secondi per accendere il Boombox. Ripeti il procedimento per spegnerlo.

BATTERIA RICARICABILE

Puoi utilizzare il KLIM Boombox quando è scollegato dall'alimentazione fintanto che la batteria interna ha sufficiente carica. Assicurati che l'interruttore sul retro del prodotto sia in posizione ON.

Indicatori di ricarica:

Lo schermo mostra il messaggio LO quando la batteria è quasi scarica.

L'indicatore batteria si illumina in rosso durante la ricarica.

L'indicatore batteria si illumina in blu quando la ricarica è completa.

MODALITÀ CD E BLUETOOTH

UTILIZZO DEL LETTORE CD

CD
MODE

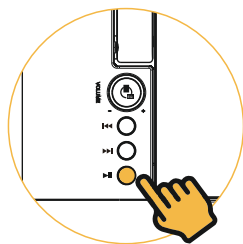
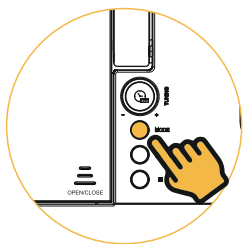
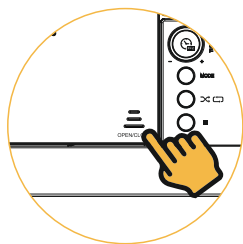

Passaggio 1: Aprire il vano CD.

Passaggio 2: Inserire il CD e chiudere il vano.

Passaggio 3: Premere il pulsante MODE e selezionare la modalità CD.

Passaggio 4: Premere PLAY/PAUSA per riprodurre il CD caricato.



Premere una volta per andare al brano precedente/successivo.



Tenere premuto per mandare avanti o indietro il brano corrente.



Durante la riproduzione di una traccia, premi una volta per abilitare la ripetizione della singola traccia. Premi ancora per abilitare la ripetizione della playlist (ALL). Premi un'altra volta per la riproduzione casuale (RAND). Premi ancora per disattivare questa funzione.

BLUETOOTH MODE

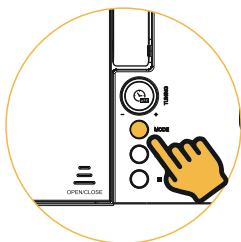

Passaggio 1: Attivare il Bluetooth sul telefono o sul tablet.

Passaggio 3: Nell'elenco dei dispositivi disponibili, individuare "KLIM Boombox B4" e selezionarlo per eseguire l'accoppiamento col Boombox.

Passaggio 2: Premere il pulsante MODE e selezionare la modalità BT.

Passaggio 4: Premere il pulsante PLAY/PAUSA per riprodurre o mettere in pausa il brano corrente. Tenere premuto per scollegare il dispositivo accoppiato.



Alcune funzioni di riproduzione, ad esempio quella che permette di mandare avanti o indietro un brano, potrebbero non essere consentite con alcuni dispositivi.

RADIO E INGRESSO AUX

UTILIZZO DELLA RADIO

Passo 1: Premi il pulsante Modalità e seleziona AM o FM, quindi estendi l'antenna per migliorare la ricezione del segnale radio.

Passo 2: Premi i pulsanti Precedente o Successivo per saltare alla stazione precedente o successiva. Usa la manopola scansione per sintonizzare manualmente le frequenze.

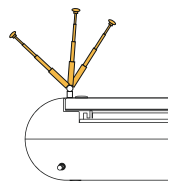
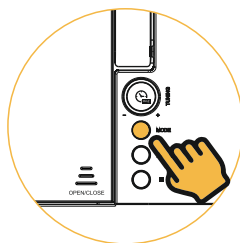

IMPOSTAZIONE DI STAZIONI RADIO PREDEFINITE



Mantenere premuto il tasto PLAY/PAUSA per scansionare le frequenze FM disponibili. Tutte le frequenze rilevate saranno salvate nei preset da P01 a P20. Una volta che la scansione automatica sarà terminata potrai premere sui pulsanti Precedente/Successivo per selezionare la stazione radio desiderata.

PORTA AUSILIARIA (IN)



KLIM BOOMBOX B4

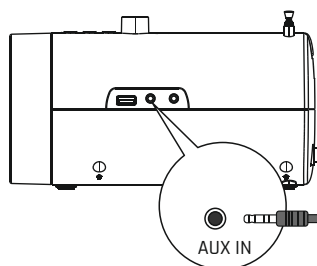

Cavo audio da jack 3,5 mm a jack 3,5 mm (non incluso)

DISPOSITIVI ESTERNI

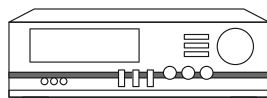

Cavo audio da jack 3,5 mm ad RCA (non incluso)

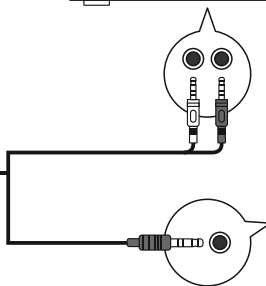

Dispositivi audio

Passaggio 1: Collegare un cavo da 3,5 mm (non incluso) alla porta AUX del KLIM Boombox.

Passaggio 2: Collegare l'altra estremità del cavo alla porta ausiliaria di uscita del dispositivo (ad es. un lettore MP3).

Passaggio 3: Premere il pulsante MODE per selezionare la modalità AUX. L'audio riprodotto attraverso il dispositivo collegato verrà emesso dal Boombox.

CUFFIE E MODALITÀ USB

PORTA AUSILIARIA (OUT)

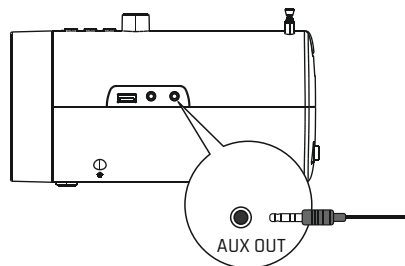

Utilizzare questa porta per collegare delle cuffie esterne al Boombox. Inserire il jack da 3,5 mm nella porta AUX a destra e l'audio sarà riprodotto attraverso le cuffie collegate. È possibile servirsi di questa porta di uscita ausiliaria per collegare il Boombox anche ad altri dispositivi compatibili tramite jack da 3,5 mm.

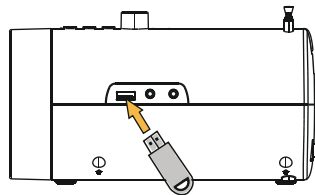

RIPRODUZIONE USB

Inserisci una pennetta USB contenente i tuoi file musicali nella porta USB sul dispositivo. KLIM Boombox entrerà in modalità USB automaticamente. Puoi premere il pulsante MODE per cambiare modalità manualmente. Il KLIM Boombox è compatibile con file audio nei formati MP3 e WMA. Capacità massima pennetta USB: 64 Gb



  Premere una volta per andare al brano precedente o successivo. Tenere premuto per mandare avanti o indietro il brano corrente.



Durante la riproduzione di un brano, premere una volta per ripetere il singolo brano. Premere nuovamente per ripetere la playlist. Premere di nuovo per annullare questa funzione. Tenere premuto per interrompere completamente la riproduzione.



In qualsiasi modalità di riproduzione, premi brevemente la manopola sinistra (EQ) per cambiare il preset di equalizzazione: FLAT / CLASSICAL / JAZZ / ROCK / POP

SPEGNIMENTO PROGRAMMATO

Puoi impostare un timer per spegnere automaticamente lo stereo dopo un certo periodo di tempo. Sposta la manopola destra verso il basso per impostare il timer a 15-30-45-60-90 minuti. Dopo aver impostato il tempo di spegnimento, lo schermo mostrerà rapidamente l'impostazione corrente con la scritta SL (SL15 = Boombox si spegnerà dopo 15 minuti). Puoi disattivare quest'impostazione tenendo premuta la manopola finché non viene mostrata la scritta OFF.

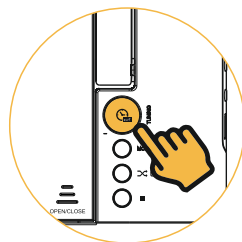

INSTALLAZIONE BATTERIA

Inserisci nel compartimento le batterie AAA incluse nella confezione.

ATTENZIONE: Assicurati che la polarità sia corretta. Non mischiare tipi diversi di batteria. Non seguire queste indicazioni potrebbe causare rischio di incendio.

Una volta scariche, gentilmente smaltisci le batterie nei recipienti preposti, in accordo con le regole del tuo comune.

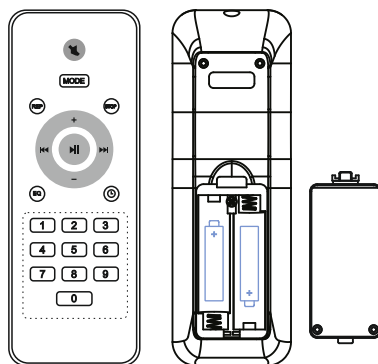

UTILIZZARE IL TELECOMANDO

Premi i pulsanti sul telecomando per eseguire le omonime funzioni dei pulsanti che si trovano sullo Stereo. Gentilmente fai riferimento alle precedenti sezioni per maggiori informazioni sulle funzioni disponibili.

Premi il pulsante  in alto per attivare/disattivare l'audio dello stereo in qualsiasi modalità di riproduzione.

I pulsanti numerici in fondo al telecomando ti consentono di saltare direttamente al numero specifico della traccia durante la riproduzione da CD o penna USB. Quando la modalità AM/FM è attiva, puoi cambiare la frequenza radio attraverso i pulsanti numerici sul telecomando.

Nota: Quando lo stereo è connesso ad un dispositivo esterno tramite cavo AUX, le funzionalità del telecomando sono limitate all'innalzamento ed abbassamento del volume od alla disattivazione completa dell'audio.

SPECIFICHE

Tensione CA: 110-240 V 50/60 Hz

Capacità batterie: 2000 mAh

Potenza altoparlante: 1,5 W x 2 (3 W totali)

Segnale altoparlante: stereo

CONTATTO E RISOLUZIONE DEI PROBLEM



Se dovessi riscontrare un qualsiasi problema con questo o un altro dei nostri prodotti, ricorda che siamo sempre a completa disposizione per assisterti. Contattaci su italia@klimtechnologies.com per ottenere assistenza. I nostri specialisti ti risponderanno entro 24 ore. Non dimenticare che il KLIM Boombox è coperto da una solida garanzia di 5 anni.



No bloquee las rejillas del aparato para permitir una adecuada ventilación y que no se sobrecaliente. No expongas esta unidad a la lluvia, líquidos o ambientes húmedos para evitar riesgos de fuego o electrocución.

Este producto contiene baterías y componentes electrónicos. Sigue las normas locales en cuanto a tratamiento de desechos si debes deshacerte del producto.

No coloques ningún objeto encima del aparato, sobre todo si continenen líquidos (como, por ejemplo, vasos llenos de agua).

La exposición a sonidos a alto volumen pueden provocar pérdida de audición. Mantén el volumen del aparato a un nivel razonable y no coloques los altavoces demasiado cerca de los oídos.



Este símbolo advierte de la presencia de voltaje peligroso en el interior de la unidad que podría constituir un riesgo de descarga eléctrica.

PRECAUCIÓN: para evitar una posible descarga eléctrica, inserta el enchufe con cuidado y de manera correcta en la toma de corriente o adaptador del voltaje adecuado.



Este producto emplea un láser Clase 1 para la lectura de CD. Si el sistema de bloqueo no funciona o está dañado, seguirá teniendo lugar radiación láser no visible cuando el reproductor de CD esté abierto. Evita la exposición directa al rayo láser en todo momento.



Este producto está equipado con una batería integrada de litio. No expongas la unidad a temperaturas altas o excesiva luz solar durante mucho tiempo ya que la batería podría sobrecalentarse y provocar un incendio. No intentes acceder a la batería. No perfores la batería para evitar riesgo de explosiones o fuego.







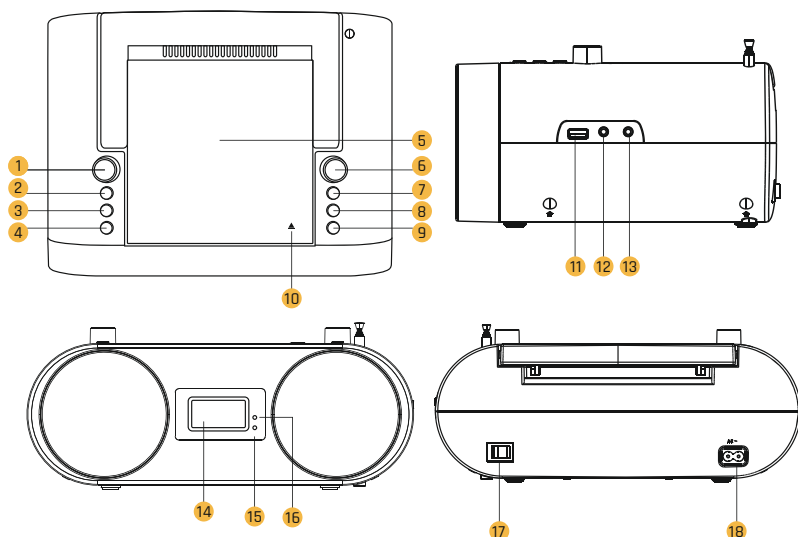





Cualquier reparación debe ser efectuada por personal experimentado y cualificado. Los daños producidos al tratar de reparar el aparato anulan la garantía. Si tuvieras cualquier problema con el dispositivo, ponte en contacto directamente con nosotros. Estamos a tu disposición todos los días: nuestros especialistas te responderán en menos de 24 horas. Recuerda que tu KLIM Boombox posee una garantía de 5 años.

CONTROLES Y CARACTERÍSTICAS



- | | | |
|------------------------------------|---------------------------|---------------------------|
| 1. ENCENDIDO / EQ / Volumen | 7. Modo | 13. Salida Aux |
| 2. Pista anterior | 8. Repetir/Aleatorio | 14. Display |
| 3. Pista siguiente | 9. Stop | 15. Indicador señal |
| 4. Play/Pause | 10. Abrir/cerrar comp. CD | 16. Indicador batería |
| 5. Compartimento del CD | 11. Puerto USB | 17. Interruptor principal |
| 6. Sintonizador / Programar reposo | 12. Entrada Aux | 18. Toma de corriente |

CARACTERÍSTICAS

	Compatible con memorias USB que contengan archivos MP3/WMA		Ecuación inteligente
	Compatible con la reproducción de audio de CD, CD-R y CD-RW		Puertos de entrada y salida AUX para conexiones con jack de 3,5 mm
	Función de radio FM/AM incorporada con banda de frecuencia ajustable		Incluye un práctico mando a distancia con dos pilas AAA.
	Compatible con dispositivos Bluetooth (BT 5.0)		Batería integrada recargable 18650 (2000 mAh)
	Pantalla LCD y control digital de volumen		Incluye protección de circuitos y de carga de la batería

PUESTA EN MARCHA

1. ALIMENTACIÓN

1. Conecta el cable de alimentación a un enchufe estándar (100-240 V - 50/60 Hz).
2. Enciende el interruptor principal en la parte trasera del Boombox.

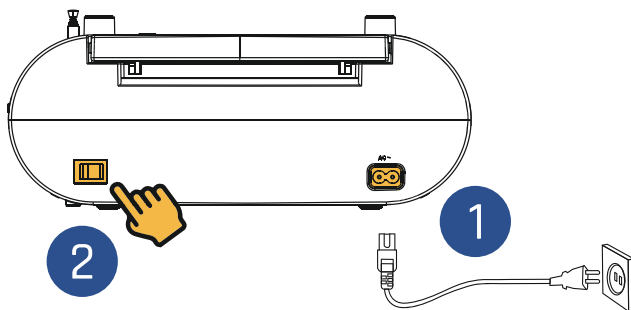

2. ENCENDIDO DEL BOOMBOX

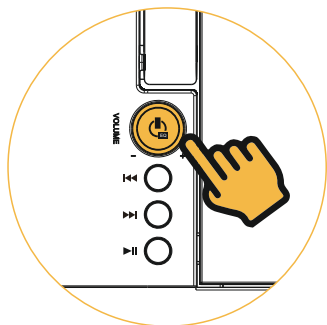

El KLIM Boombox tiene un sistema de recarga de baterías que funciona al conectarse a la corriente. **ATENCIÓN:** La batería no es extraíble. Si no vas a usar el aparato durante un tiempo, apaga el interruptor principal y desenchufa el aparato.

Pulsa la rueda ENCENDIDO/EQ durante 3 segundos para encender el reproductor. Repite este paso para apagarlo.

BATERÍA RECARGABLE

Puedes usar el reproductor mientras está desenchufado, siempre y cuando la batería tenga suficiente carga. Asegúrate de que el interruptor principal en la parte trasera esté en la posición ON.

Indicadores de carga:

La pantalla muestra el mensaje «LO» cuando el nivel de batería es bajo.

El indicador de batería se enciende en rojo mientras carga.

El indicador de batería se enciende en azul cuando está completamente cargada.

MODOS CD Y BLUETOOTH

REPRODUCCIÓN DE CD

CD
MODE

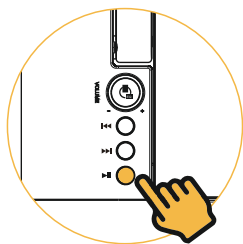
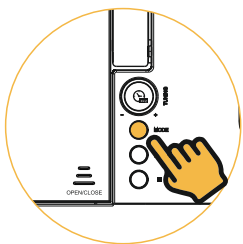
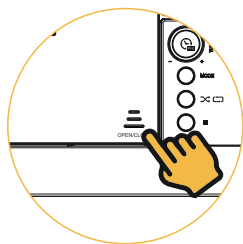

Paso 1: abre el compartimento de CD.

Paso 2: coloca dentro el CD y cierra el compartimento.

Paso 3: presiona MODE y selecciona el modo de CD.

Paso 4: presiona PLAY/PAUSE para reproducir el CD.



Presiona una vez para ir a la pista anterior/siguiente.



Mantén pulsado unos segundos para adelantar o rebobinar la pista actual.



Mientras se esté reproduciendo la pista, pulsa una vez para repetirla (ONE). Pulsa otra vez para repetir la lista de reproducción (ALL). Pulsa de nuevo para activar la reproducción aleatoria (RAND). Pulsa otra vez para cancelar la repetición (OFF).

MODO BLUETOOTH

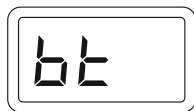
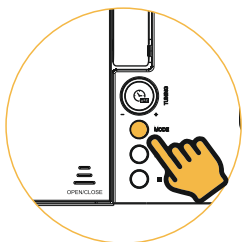

Paso 1: activa el Bluetooth en tu teléfono o tablet.

Paso 3: busca «KLIM Boombox B4» entre la lista de dispositivos disponibles y selecciónalo para sincronizarlo con el Boombox.

Paso 2: pulsa MODE y selecciona el modo BT.

Paso 4: presiona el botón PLAY/PAUSE para reproducir o pausar la pista seleccionada. Presiona y mantén pulsado para desconectar el dispositivo.



Dependiendo del dispositivo conectado, puede que algunas opciones de reproducción como el avance rápido o el rebobinado no funcionen.

RADIO Y ENTRADA AUXILIAR

USO DE LA DE RADIO

Paso 1: presiona el botón MODE y selecciona FM/AM. Extiende la antena FM para mejorar la recepción de la señal de radio.

Paso 2: pulsa PREV o NEXT para ir a la anterior o siguiente emisora disponible respectivamente. Usa la rueda de sintonización para seleccionar manualmente la frecuencia.

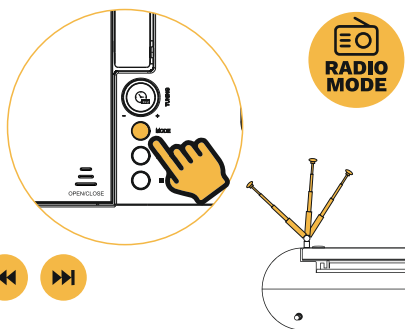

CONFIGURACIÓN DE LAS PRESINTONÍAS



Mantén pulsado el botón PLAY/PAUSE para escanear automáticamente las frecuencias FM disponibles. Todas las frecuencias detectadas se guardarán en las presintonías P01 a P20. Una vez termine de guardarlas, pulsa PREV/NEXT para cambiar de presintonía.

PUERTO AUXILIAR (ENTRADA)

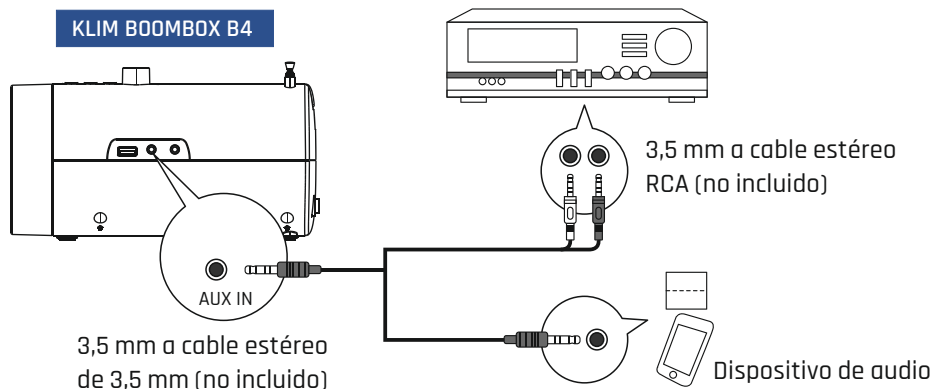

Paso 1: conecta un cable de audio de 3,5 mm (no incluido) al puerto AUX del KLIM Boombox.

Paso 2: conecta el otro extremo al puerto de tu dispositivo externo (por ejemplo, un MP3)

Paso 3: presiona el botón MODE para seleccionar el modo AUX. El audio que se reproduzca en el dispositivo conectado sonará ahora a través del Boombox.

PUERTO AUXILIAR (SALIDA)

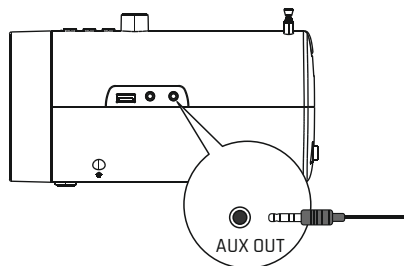

Utiliza este puerto para conectar unos auriculares externos al Boombox. Enchufa el jack de 3,5 mm al puerto AUX ubicado a la derecha y podrás disfrutar de la música a través de los auriculares. También podrás utilizar este puerto auxiliar para conectar el Boombox a otros dispositivos compatibles con un jack 3,5 mm.

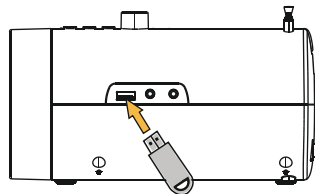

REPRODUCCIÓN DE USB

Conecta una memoria USB con tus archivos de música en el puerto. El aparato cambia a modo USB automáticamente. También puedes pulsar el botón MODE para seleccionarlo manualmente. El KLIM Boombox es compatible con formatos de audio MP3 y WMA. Capacidad máxima de la memoria USB: 64 Gb



  Presiona una vez para ir a la pista anterior/siguiente.

Mantén pulsado para adelantar o rebobinar la pista actual.

Mientras se esté reproduciendo la pista, presiona una vez para repetirla. Presiona otra vez para repetir la lista de reproducción. Presiona otra vez para cancelar el modo de repetición. Mantén pulsado para detener del todo la reproducción.



En cualquier modo de reproducción, pulsa brevemente la rueda ENCENDIDO/EQ para ajustar el ecualizador (FLAT / CLASSICAL / JAZZ / ROCK / POP).

REPOSO PROGRAMADO

Puedes programar un temporizador para que el reproductor se apague una vez transcurra un tiempo determinado. Pulsa la rueda derecha hacia abajo para configurar el temporizador a 15-30-45-60-90 minutos. Nada más pulsar el botón, la pantalla muestra la configuración activa con el texto SL (SL15 = el reproductor se apaga en 15 minutos). Puedes cancelar esta función pulsando la rueda de nuevo hasta que se muestre el texto OFF en la pantalla.

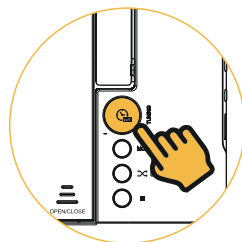

MANDO A DISTANCIA

INSTALACIÓN DE LAS PILAS

Inserta las pilas AAA incluidas en el compartimento posterior.

ATENCIÓN: asegúrate de respetar la polaridad. No mezcles distintos tipos de baterías. No respetar estas indicaciones puede provocar un riesgo de incendio.

Una vez agotes la carga de las baterías, deséchalas de forma respetuosa con el medio ambiente y siguiendo la normativa local.

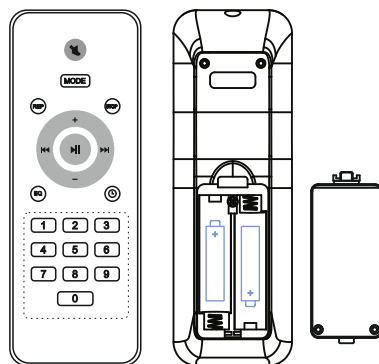

USO DEL MANDO

Pulsa los botones del mando a distancia para ejecutar las mismas funciones que si pulsases los botones del reproductor. Consulta la sección correspondiente a cada función en las páginas anteriores para saber más sobre cómo usarlas.

Pulsa el botón  de la parte superior del mando para silenciar el volumen en cualquier modo.

Los botones numéricos de la parte inferior te permiten saltar a un número de pista concreto mientras estás en modo CD/USB. Mientras el modo FM/AM está activo, puedes cambiar la frecuencia pulsando los números del mando.

Nota: mientras el reproductor está conectado a un dispositivo externo mediante el puerto auxiliar, las funciones del mando están limitadas a cambiar el volumen y silenciar los altavoces.

ESPECIFICACIONES

Voltaje: 110-240 V 50/60 Hz

Capacidad de batería: 2000 mAh

Potencia del altavoz: 1,5 W x 2 (3 W total)

Señal del altavoz: estéreo

CONTACTO Y RESOLUCIÓN DE PROBLEMAS



Si tienes algún problema con este aparato o cualquiera de nuestros productos, recuerda que estamos a tu disposición para resolver cualquier incidencia. Escríbenos a espana@klimtechnologies.com para recibir asistencia. Nuestros especialistas siempre responden en menos de 24 horas. Y no olvides que el KLIM Boombox está cubierto por una garantía de 5 años.



WWW.KLIMTECHS.COM

Authorised EU representative

Marcus Excelsior Limited
Bracken Road No 51, Carlisle Offices
D18CV48 Dublin, Sandyford
Dublin, Ireland

Marcus Excelsior Limited

2512 Langham Place Office Tower
8 Argyle Street, Mongkok, Kowloon
Hong Kong