

CUSTOM-MADE

KITCHENS

CATALOGUE

**BLACK
RED
WHITE**

2021 COLLECTION



SENSO KITCHENS



47TH SCOTT AVENUE - LATTE OAK / WHITE MATT

EXPLORE THE ADVANTAGES OF SENSO KITCHENS

FRONTS

An essential element of the kitchen. Their shape is the main determinant of the interior's character. Modern, minimalist, scandinavian or maybe classic style? We have many ideas for you.



HANDLES

Their colour, shape, and finish may add the final touch to the kitchen. Only when properly selected will they become a unique decoration. Choose your style from the broad selection of designs.

EQUIPMENT

Looking for the things you need, mess, disorganisation. Easy. The wide range of equipment of kitchen cabinets will provide you with only the positive emotions associated with cooking.

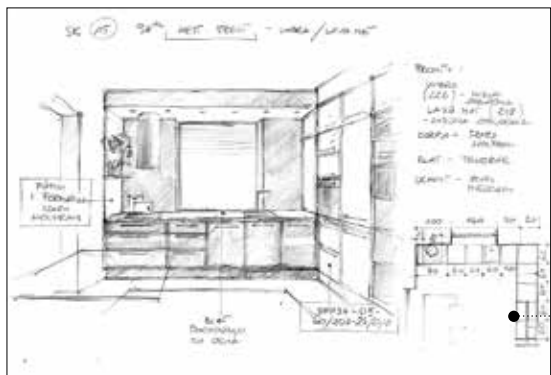

DESIGN AND 3D VISUALISATION

There are many aspects that should be taken into account when creating the perfect kitchen. We're here to help you. Take advantage of our designers.

CAPITAL



42 ND MARCHE AVENUE	6
49 TH CORTESE AVENUE	8
33 RD SAPERAVI AVENUE	10,14,89
36 TH NORDE AVENUE	14,26,32,40,89
38 TH ELYSEE AVENUE	16,18,20,26,28,30,32,50,95
47 TH SCOTT AVENUE	2,22,24
43 RD LUVAK AVENUE	34,36
32 ND MALBEC AVENUE	38



TRAFFIC



84 TH BOARD STREET	6,16,40,48,49,50,52,95
98 TH ELYSEE STREET	42,48
97 TH WEST STREET	44,46
87 TH SMOOTH STREET	49,54,55
94 TH CORTESE STREET	56
96 TH YORK STREET	58,59



ROYAL



KASSETA	60,74
TORRETO	62
FRIGG	64
IMPEROR	66
GLADIO	68
ELENORE	70
DRAGGO	72



SENTIMA



KASSETA	76
PIERWSZA MIŁOŚĆ	78

EQUIPMENT	80
FRONTS	90
BODIES/COUNTERTOPS	94
CABINETS	96



CAPITAL

BEAUTIFUL KITCHENS, FULL OF GREAT POSSIBILITIES

The kitchen furniture from the **Capital group** have a tasteful and modern design, which is the result of combining style and the highest quality. The natural veneer, real wood, matt or glossy varnishes, branded accessories with a lifetime warranty, and the widest range of additional equipment offer countless possibilities for creating a perfectly matched kitchen. Take the opportunity to create a kitchen that suits not only your taste but also your lifestyle.





NEW

**42ND MARCHE AVENUE - LIGHT GREY /
84TH BOARD STREET - STONE OAK**



knots and cracks
inspired by nature



chair **MADISON** - w/D/H 45/53/96,5 cm
D09-TXK_MADISON-TX142-1-TK_RIVIERA_100_BLACK
table **MADISON** - w/D/H 90/150-200/77 cm
D09043-TXS_MADISON-TX058/TX142



a practical, retractable table,
hidden behind the drawer front



CAPITAL

impressive
finish of the
tall cabinet
with an external
cover panel

NEW

49TH CORTESE AVENUE - GREY METEO

CAPITAL



Black
matt
varnish

33RD SAPERAVI AVENUE – BLACK MATT



WITH A GLASS ACCENT

The combination of natural oak and grey matt is the perfect formula for a beautiful and timeless interior. Every detail here determines its appearance. Just like black tempered glass, which fills the space created by the precise milling of the handle lines.



chair **MARYNARZ** - W/D/H 46/53/95 cm
D09-TXK_MAR/POZ/2-TX069-1-TK_ENDO_7713_TAUPE
table **BRYK** - W/D/H 80/140-180/76 cm
D09-TXS_143-TX069



modern,
veneered
fronts with a glass
accent

CAPITAL



33RD SAPERAVI AVENUE – NATURAL OAK / LIGHT GREY MATT



33RD SAPERAVI AVENUE – GREY METEO GLOSS
36TH NORDE AVENUE – NATURAL CRUD OAK

CAPITAL



CAPITAL



a modern, energy efficient
island hood



●
matt,
varnished fronts
with an integrated
handle

**38TH ELYSEE AVENUE WITH L4 HANDLE – LAVENDER MATT /
84TH BOARD STREET WITH L4 HANDLE – GREY FERRO**

CAPITAL



modern, varnished
fronts with
an original
handle line

38TH ELYSEE AVENUE WITH L5 HANDLE – CAPPUCINO MATT

The perfectly smooth cappuccino coloured fronts, glossy or matt, gently float above the pine floor and black plinths. The handles, which break the severity of simple forms, attract attention like a magnet.



functional, storied Cargo baskets



BOTTLE GREEN

Here's a colour that will make a striking impression in the kitchen. Lively, energetic, beautiful. So as not to overshadow its charm, it's discreetly accompanied by elements in grey matt. This is a kitchen for people who like to stand out!



chair **VARIO 2** - W/D/H 48/51/86 cm
D09-TXK_VARIO_2-TX099-1-TK_AMORE_22_BLACK
table **BERNARDIN** - W/D/H 95/95-195/76 cm
D09030-TXS_BERNARDIN-DSO-1-BLA+KOR+AKC01



a system of modern,
metal racks

CAPITAL



38TH ELYSEE AVENUE WITH L4 HANDLE – BOTTLE GREEN MATT

CAPITAL



47TH SCOTT AVENUE – NATURAL OAK / GREY PEARL

The cool shade of grey of the surrounding brings out the warmth of the oak veneer on the furniture. In the lower cabinet installations the main role is played by an interesting division of fronts.



functional and spacious drawers
for kitchen accessories



CAPITAL



47TH SCOTT AVENUE – INK / WENGE OAK



varnished,
matt
fronts



modern, veneered fronts
with an integrated
aluminium handle

CAPITAL

varnish
in matt finish

36TH NORDE AVENUE WITH L2 HANDLE – NATURAL OAK /
38TH ELYSEE AVENUE WITH L2 HANDLE – MAGNOLIA MATT

A BREATH OF LIGHTNESS

Warm wood-coloured countertops and furniture sides are ideally combined with fronts covered with a varnished coating. This duo takes centre stage in the interior, tones and calms it down. The ideal solution for a kitchen where we spend a lot of time, indulging in culinary pleasures.



CAPITAL

varnished,
high gloss fronts

38TH ELYSEE AVENUE
WITH L0 HANDLE – MAGNOLIA GLOSS

CAPITAL



38TH ELYSEE AVENUE WITH L0 HANDLE
ROSE/LIGHT GREY GLOSS



CAPITAL



36TH NORDE AVENUE WITH L0/L146 HANDLE – CRUD RUDE OAK/**38TH ELYSEE AVENUE** WITH L0 HANDLE – GREY MATT

Colourful fronts liven up the kitchen and give it some character, while the practical, integrated handles emphasize the modern furniture design. Selected cabinets have a unique type of integrated handle L146, located in the middle of the front.



modern, veneered fronts
with integrated aluminium

A PINCH OF NATURE

The expressive decor – crud rude oak – faithfully reflects the cracks and rings of natural wood. A pinch of nature in the very centre of the kitchen. The kitchen, though small, has everything it needs to give every day a good start.



chair **ALHAMBRA** - W/D/H 44/50/96 cm
D09-TXK_ALHAMBRA-TX053-1-EKWADOR_2417_BLACK
table **ALHAMBRA** - W/D/H 90/140-180/76 cm
S306-STO/140-AHB/CA



CAPITAL





43RD LUVAK AVENUE –
LIGHT GREY MATT / GREY GRAPHITE

CAPITAL



43RD LUVAK AVENUE – CHAMPAGNE

Decorative crown mouldings and some beautiful accessories prove that the Luvak kitchen also looks good in a slightly more classic design.



varnished, matt fronts

DARK CHOCOLATE

Dark veneered fronts with black glass handles and almost invisible, typical kitchen equipment – all this blurs the line between a kitchen and a room.



chair **PATRAS** - W/D/H 44/51/94,5 cm
D09-TXK_PATRAS-TX100-1-TK_ENJOY_SILVER_20
table **PATRAS** - W/D/H 90/135-180/77 cm
D09033-STO_PATRAS-DARL



modern, veneered fronts
with a glass accent

A modern kitchen featuring dark wood cabinetry with horizontal slats. A sink with a chrome faucet is positioned under a window with white blinds. To the right, built-in appliances including a refrigerator and an oven are visible. A teal bowl sits on a shelf above the oven. The floor is made of dark wood with a large, shaggy rug in the foreground.

CAPITAL

32ND MALBEC AVENUE – CHESTNUT OAK

TRAFFIC

CHARACTER DEFINED BY COMPOSITION, PRECISION AND SHAPE

Explore the modern kitchens from the **Traffic group**. Furniture that will surprise you with its abundant functionality, catch your eye with its unique style, and flexibly adapt to your home budget. You can choose the fronts, made of modern materials, according to your expectations, just like the handles that will dot the i's and cross the t's in your kitchen kingdom. Play with style and colours to create your own image of the perfect kitchen.





**84TH BOARD STREET WITH L4 HANDLE - METAL SLATE GREY /
36TH NORDE AVENUE WITH L4 HANDLE - NATURAL CRUD OAK**



a practical organiser
for kitchen accessories



Le Mans – a functional
and convenient corner system



TRAFFIC



98TH ELYSEE STREET WITH L3 HANDLE - GRAPHITE MATT/WHITE MATT

TRAFFIC



97TH WEST STREET - TIBERO ASH/TRUFFLE MATT

A dining room and kitchen in one room. Ergonomic kitchen design and eye-catching colours are the formula for a friendly space that will never get boring.



modern, matt fronts
with a clear woodgrain pattern

A PERFECT DUO

The uniform colour of wall cabinets and the structure of the base ones share the same shape of fronts and the characteristic copper-coloured handle. This gives the kitchen two faces that perfectly match each other.



chair **KALIO** - W/D/H 43/57/90 cm
D09-TXK_KALIO-TX098-1-TK_GOBI_02
table **KALIO** - W/D/H 90/135-180/77 cm
D09036-STO_KALIO-TX098/ACZ



TRAFFIC



practical segregation baskets
with a central cover



97TH WEST STREET – MYSTICAL MATT / GREY TISANO OAK

TRAFFIC



varnish
in matt finish

84TH BOARD STREET – GREY FERRO /
98TH ELYSEE STREET WITH L2 HANDLE
– LIGHT GREY MATT

READY FOR ANYTHING

It's a good idea to plan out the open space of the apartment in such a way as to make it pleasing to the eye, to let you work freely and to allow unexpected guests to come in at any time. Open shelves and countertops let you quickly change the arrangement. What we don't want to show can be hidden behind the fronts of the cabinets.





84TH BOARD STREET WITH L1 HANDLE – STONE OAK
 / 87TH SMOOTH STREET WITH L1 HANDLE – WHITE GLOSS



chair **FARIO** - W/D/H 46/54/85 cm
 D09-TXK_FARIO-TX069-1-TK_MINDELO_12_GREY



table **FARIO** - W/D/H 80/120-160/78 cm
 D09050-TXS_FARIO-DSO

TRAFFIC



84TH BOARD STREET WITH L4 HANDLE – TABAC OAK /
38TH ELYSEE AVENUE WITH L4 HANDLE – BLACK MATT



TRAFFIC



84TH BOARD STREET CHROMIX WHITE WITH L2 HANDLE

The addition of metal elements to the furniture design will be ideal for any interior. Wooden shelves are the best match for metal racks and the wall in the background can be made of concrete or stone.



modern fronts imitating
concrete colours

WITH A MODERN TOUCH

It is a kitchen that offers great possibilities of arrangement. The unusual height of the unit allows you to arrange the space in an interesting way. Instead of tall cabinets hiding everything, you can add decorations here and give the interior character.



chair **FARIO** - W/D/H 46/54/85 cm
D09-TXK_FARIO-TX098-1-TK_MINDELO_12_GREY
table **FARIO** - W/D/H 80/120-160/78 cm
D09050-TXS_FARIO-BAL





87TH SMOOTH STREET WITH L1 HANDLE –
DARK OXID / KOBE MATT



chair **BERGEN** - w/D/H 45/50/95 cm
D09-TXK_BERGEN-TX118-1-ARUBA_18_GREY

table **BERGEN**
W/D/H 90/160-200/76 cm
S359-STO/160-MSZ





87TH SMOOTH STREET WITH L2 HANDLE – GREY STEEL

A KITCHEN WITH CHARACTER

Dark kitchen with a unique design. The grey colour on the horizontal arrangement of the base cabinets is adjacent to the glossy black glass of the vertical displays. The whole composition is finished with an architectonic frame.



A DISCREET CHARM OF ELEGANCE

Monochromatic cabinet installations and light from the large window create an interior which helps you to relax. The combination of white and the warm shade of wood adds elegance and class to the kitchen, and the black handles introduce a beautiful contrast and perfectly match the modern kitchen appliances.



chair **HOLTEN** - W/D/H 47/54/98 cm
D09-TXK_HOLTEN-TX098-1-TK_SORO_90_GREY
table **HOLTEN** - W/D/H 90/160-200/76,5 cm
D09027-TXS_STO_HOLTEN-DWO/BAL



impressive finish of cabinets with cover panel highlighting the visual qualities of the kitchen

TRAFFIC



NEW

94TH CORTESE STREET WITH Z1 HANDLE - WHITE SUPER MATT



NEW

**96TH YORK STREET - DELICE MATT/
BLACK MATT**

IN MATT FINISH

Beautiful and practical — these are the distinguishing features of matt kitchen cabinet fronts. The combination of the elegant black with the pastel pink creates an original composition. All this is balanced by the grey shade of countertops imitating the structure of marble.



TRAFFIC



NEW

96TH YORK STREET - WHITE MATT



chair **Robi** - W/D/H 43/50/92 cm
D09-TXK_ROBI-TX098-1-TK_ADEL_6_GREY



table **BRYK 2** - W/D/H 80/140-180/76 cm
D09024-TXS_BRYK_2-BAL

ROYAL

A UNIQUE LOOK AT THE KITCHEN

Royal interiors need a noble setting. **Royal kitchens** are a wide selection of fronts made of natural wood, as well as high quality panels covered with durable varnish. All in a timeless, classical style, the hallmarks of which are expressive carvings, millings, or elaborately made handles. Inside, there are many functional solutions that you can select yourself. Just like the accessories with a lifetime guarantee of quality that will ensure that you feel as comfortable as possible every day.





KASSETTA - GREY GRAPHITE

IN A BEAUTIFUL SETTING

Navy blue is a colour full of elegance and style. Wooden fronts in ink beautifully match the noble shade of grey. Graphic shapes of furniture look great against the background of such a kitchen. Class and elegance of its own.



chair **ALLA 4** - W/D/H 44/54/96,5 cm
D09-TXK_ALLA_4-TX098-1-TK0
table **STO 110/75** - W/D/H 75/110-150/77 cm
D09-STO/110/75-BAL



stylised,
gold-coloured handles

ROYAL



natural
oak
wood

NEW

TORRETO - INK



ROYAL



FRIGG - MOCHA OAK

ROYAL



IMPEROR – BIANCO OAK

Simple furniture arrangement, where both function and decorative value are equally important. Decorative milled lines and delicate handles add a touch of elegance to the fronts. This makes them the essence of a classic kitchen design. The display topped with a decorative moulding, showcasing your favourite Tableware watches over everything.



THE ESSENCE OF CLASSIC DESIGN

A kitchen designed in the spirit of classicism emanates with the tranquillity and charm of past eras. In the traditional interior there is also room for an island — a creation of contemporary design. Isn't it beautiful?



chair **IDENTO** - W/D/H 44/57/95 cm
D09-TXK_IDENTO-TX098-1-NOVEL_13_GREY
table **IDENTO** - W/D/H 85/145-185/77 cm
S320-STO/145-BI



the classic hood
after a makeover

ROYAL



natural
wood

GLADIO – MOCHA OAK

The displays grouped in two hanging rows gave way to a large window providing the countertop with additional light. Massive fronts made of solid wood are decorated with a subtle handle with a lace rim.



a classic front
with a wooden frame



ROYAL



natural wood



a practical system of internal compartments of a drawer made of solid wood



ELENORE – MARZIPAN

BLOTCH OF COLOUR

Traditional kitchen with... attitude! Beautiful, subdued in colour, the furniture has created a beautiful, cosy space that comes to life thanks to the navy blue blotch. Look at the wall cabinet installations. That's what will catch the attention of all of your guests.



chair **HOLTEN** - W/D/H 47/53/98 cm
D09-TXK_HOLTEN-TX098-1-TK_SORO_90_GREY



varnished wood

decorative, milled fronts
finished in matt

ROYAL



DRAGGO – LIGHT GREY / INK

ROYAL



naturalne
drewno

KASSETTA – LIGHT GREY

The grey, varnished fronts and a functional island somewhat change the character of the kitchen maintained in a simple, classic style. However, a sudden turn towards modernity is hampered by traditional millings and beautiful displays, filled right up to the ceiling with beautiful dinnerware and accessories.



functional organisers
for high drawers



SENTIMA

FASHIONABLE KITCHENS IN A CLASSIC SHAPE

A love for classicism can also be reflected in the kitchen. Explore the kitchens fronts from the **Sentima group** and discover the most economical solutions for tailor-made furniture at attractive prices. You can choose your own style from many available designs and colours of fronts, and ensure the functionality of the interior by choosing professional accessories and additional elements.





KASSETTA - WHITE CANADIAN



PIERWSZA MIŁOŚĆ - LIGHT BEIGE

Contrasting combinations of colours, textures and shapes are the essence of this interior. Classic furniture is complemented by rustic kitchen appliances and tiles in strong colours balancing between black and graphite.



SENTIMA



chair **AROSA** - W/D/H 44/50/96 cm
D09-TXK_AROSA/2-TX012-1-EKWADOR_2417_BLACK
table **AROSA** - W/D/H 90/140-180/76 cm
S346-STO/140/A-DABR/CAP



classic,
milled fronts

EQUIPMENT

A KITCHEN WITH NO LIMITS

The right equipment can completely change the kitchen. To ensure the highest comfort of work, we offer you a whole lot of advanced technical solutions. We will not only ensure the order and optimal arrangement of the interior of cabinets but also their aesthetic appearance. Find out how small items and some clever solutions can give everyday life a completely different taste.





STORAGE

Every element of a well-designed kitchen is equipped according to the needs and expectations of users. Properly selected accessories allow you to enjoy cooking, eating, and living.

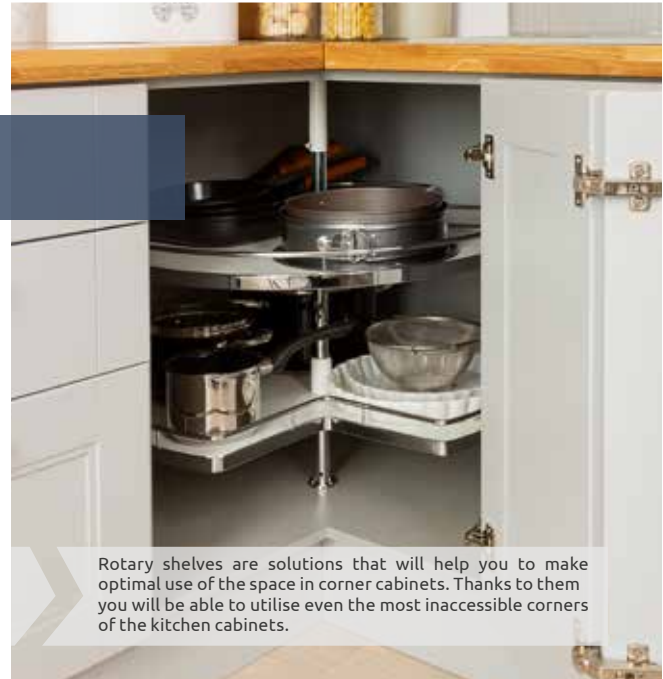

Rotary shelves are solutions that will help you to make optimal use of the space in corner cabinets. Thanks to them you will be able to utilise even the most inaccessible corners of the kitchen cabinets.



The system of professional Cargo baskets will allow you to efficiently organise space. Easy access to supplies and capaciousness are undoubted advantages of such a solution.



Tower-type Cargo basket provides comfortable and ergonomic storage of supplies. The internal drawers can be freely arranged and adapted to your individual needs. The pull-out shelves with soft close allow you to make full use of the space available. They are perfect for base kitchen cabinets.



The pull-out shelves with soft close allow you to make full use of the space available. They are perfect for base kitchen cabinets.



The functional baskets facilitate the organisation of work in the kitchen, and the use of the full-extension slides and soft close makes it even more comfortable.



The number of essential supplies, dishes and equipment in the kitchen makes it necessary to use organisation systems inside the cabinets. This is the only way to reduce the number of displayed items.



The Blum internal drawer system provides plenty of space for products and direct access to them on three sides.



A practical set of bins for waste sorting – Unico. Space next to the bins can be used for storing cleaning products, bags, etc.



The subtle dividers and organisers for drawers are accessories which will make it easier for you to maintain order and ensure that everything is in place.



Thanks to the use of high drawers and their inner organisation systems you can have a pantry in the middle of the kitchen at your disposal.



Practical organisers allow you to adapt the drawer to the storage of any type of content, ensuring order.



Öko-Liner waste segregation system is a convenient solution that makes everyday work in the kitchen easier. The set also includes a metal cover, which can be used as a shelf.



Blum Tandembox Intivo drawer system gives you the opportunity to individually arrange the interior of the drawer by means of the dividing system.



The solid beechwood inner dividing system of the drawer gives the drawer a specific function.



Kitchen drawers have various applications. An interesting solution is the possibility of storing bread there, thanks to which you will gain extra space on your countertop.



Low drawers, due to their small dimensions, are a perfect place for storing small kitchen accessories.



The inner dividing systems for drawers allow you to plan and arrange drawers in accordance with your individual needs.

PRACTICAL SOLUTIONS

Modern solutions increase the functionality of the kitchen interior. Various accessories, not necessarily intended to be used in the kitchen, may prove to be extremely helpful also in the kitchen.



The USB socket hidden in the countertop is a functional part of kitchen equipment. It is almost invisible, so it does not get in the way of the countertop aesthetics and remains a neutral part of the equipment.



The socket discretely hidden in the countertop allows for the free use of any kitchen appliances requiring direct access to electricity, such as a blender, food processor, or a juicer.



The iMove system turns a traditional upper cabinet into modern and ergonomic storage space, so you can enjoy full access even to the highest shelves.



Thanks to the AVENTOS lift system, the one-piece front can be easily opened upwards and stopped in any position. It is ideal for use in upper cabinets.



Kitchen hanging rails – rails and various hooks on which you can hang items – they allow you to arrange a difficult space. They don't take up much space, but they make the kitchen functional and encourage kitchen activities.



Metal racks for the kitchen are an interesting decorative element, which will work well in modern and loft interiors. Open shelves give the effect of lightness and at the same time they are extremely practical.



Metal racks in the bottom cabinet installations are a less obvious solution but equally spectacular. An interesting place to set up such shelves is a kitchen island, directed towards the room.



The built-in vacuum cleaner installed in the furniture plinth is a practical solution for the kitchen. It ensures perfect cleanliness and it does not take up much space.

LIGHTING

Functional and energy efficient lighting solutions are an unconventional way to change every interior.



The lighting mounted on the bottom of upper cabinets will illuminate the countertop in the kitchen, greatly facilitating the preparation of meals.



The LED luminaire will work perfectly for illuminating countertop, the interiors of cabinets, as well as displays in a kitchen in every style.

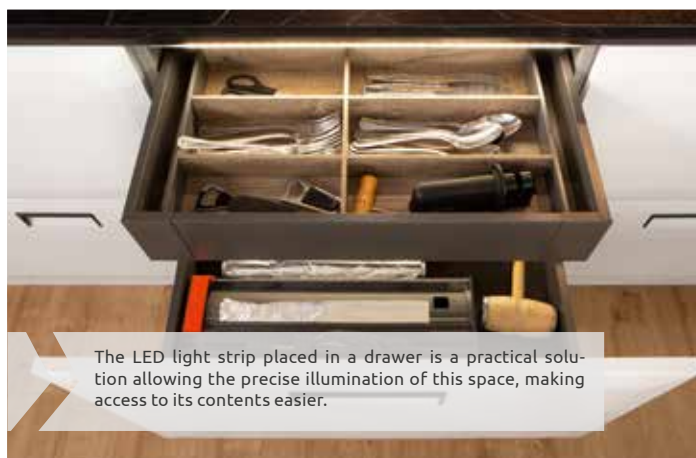

The LED light strip placed in a drawer is a practical solution allowing the precise illumination of this space, making access to its contents easier.



LED luminaire dedicated for lovers of technological novelties, who primarily value quality and economy, as well as care for the environment.



33RD SAPERAVI AVENUE – GREY METEO GLOSS
36TH NORDE AVENUE – NATURAL CRUD OAK

CAPITAL FRONTS

47th scott avenue

material: HDF board, varnish
available only in matt



Available in colours: 1-58

33rd saperavi avenue

material: MDF board, varnish
available in gloss and matt



Available in colours: 1-58

38th elysee avenue

material: MDF board, varnish
available in gloss and matt



Available in colours: 1-58

43rd luvak avenue

material: HDF board, varnish
available only in matt



Available in colours: 1-58

42nd marche avenue

material: wood, veneer,
MDF board



Available in colours:
2, 3, 7, 12, 20, 29, 50, 52,
59-63

32nd malbec avenue

material: wood, veneered board,
natural veneers



Available in colours: 59-63

36th norde avenue

material: veneered board,
natural veneers,
aged veneer



Available in colours:
2, 3, 7, 12, 20, 29, 50, 52,
59-63 oraz 64-66

47th scott avenue

material: wood,
veneered board



Available in colours: 59-63

33rd saperavi avenue

material: veneered board,
natural veneers,
aged veneer



Available in colours:
59-63 oraz 64-66

49th cortese avenue

material: HDF board, varnish
available only in matt



Available in colours:
1-58, 77-111

01 snow white

02 white

03 magnolia

04 latte

05 porcelain

06 chalky white

07 light grey

08 milk

09 parisian

10 parchment

11 tea colour

12 pearl grey

13 pigeons

14 grey pearl

15 grey

16 light grey

17 grey meteo

18 stylish grey

19 graphite

20 grey graphite

21 lavender

22 patina

23 coastal blue

24 scandinavian

25 blue

26 atlantic

27 l'azure

28 azure

29 ink

30 navy blue

31 sesame

32 marble

33 lilac

34 jasmine

35 cappucino

36 sand

37 grey beige

38 brown

39 granite

40 black

41 mokate

42 seashell

43 oyster white

44 cream

45 white cream

46 orchid

47 delice

48 rose

49 pearl copper

50 porto

51 honey

52 beige pearl

53 beige

54 light beige

55 champagne

56 aquamarine

57 avocado

58 bottle green

59 canadian oak

60 latte oak

61 natural oak

62 chestnut oak

63 wenge oak

64 natural rude oak

65 crud rude oak

66 crud marone oak

TRAFFIC FRONTS

84th board street

material: laminated board



Available in colours:
67-76

97th west street

material: HDF board, PVC foil with horizontal grain in option



Available in colours:
77-111

96th york street

material: HDF board, PVC foil with horizontal grain in option

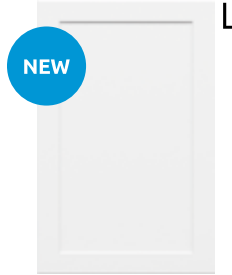

Available in colours:
1-58, 77-111

94th cortese street

material: MDF board, PVC foil with horizontal grain in option



Available in colours:
1-58, 77-111

87th smooth street

material: MDF board, PVC foil with horizontal grain in option

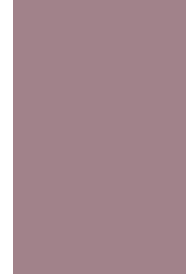

Available in colours:
77-121

91st court street

material: MDF board, varnish, available only in matt



Available in colours:
1-58

98th elysee street

material: MDF board, varnish, available in gloss and matt



Available in colours:
1-58

67	chromix white	77	white super matt	88	marone	98	pacific	107	kobe matt	112	white polysk
68	mountain oak	78	white canadian	89	sonoma oak	99	cobalt metallic	108	capri	113	jasmine gloss
69	stone oak	79	white smooth	90	riviera oak	100	metallic titanium	109	green ontario	114	vanilla gloss
70	lancelot oak	80	magnolia pearl	91	structure oak	101	dark oxid	110	grey loire oak	115	beige gloss
71	lancelot grey oak	81	light grey matt	92	nature halifax oak	102	light oxid	111	black matt	116	light grey gloss
72	tabac oak	82	alabaster matt	93	grey tisano oak	103	ferro	117	pigeons gloss	118	mohave gloss
73	lincoln walnut	83	mussel matt	94	tibero ash	104	grey steel	119	sand gloss	120	grey gloss
74	brown ferro	84	acacia	95	tabac halifax oak	105	grey wolfram	121	black gloss		
75	grey ferro	85	light beige	96	catania oak	106	mystical matt				
76	metal slate grey	86	cashmere	97	wenge oak magic						
		87	truffle matt								

01	snow white	11	tea colour	21	lavender	31	sesame	41	mokate	51	honey
02	white	12	pearl grey	22	patina	32	marble	42	seashell	52	beige pearl
03	magnolia	13	pigeons	23	coastal blue	33	lilac	43	oyster white	53	beige
04	latte	14	grey pearl	24	scandinavian	34	jasmine	44	cream	54	light beige
05	porcelain	15	grey	25	blue	35	cappucino	45	white cream	55	champagne
06	chalky white	16	light grey	26	atlantic	36	sand	46	orchid	56	aquamarine
07	light grey	17	grey meteo	27	l'azure	37	grey beige	47	delice	57	avocado
08	milk	18	stylish grey	28	azure	38	brown	48	rose	58	bottle green
09	parisian	19	graphite	29	ink	39	granite	49	pearl copper		
10	parchment	20	grey graphite	30	navy blue	40	black	50	porto		

ROYAL FRONTS

Draggo

material: wood, veneer, MDF board



Available in colours: 59, 61-65

Elenore

material: wood blank



Available in colours: 60,66

Imperor

material: wood blank



Available in colours: 59, 61-65

Frigg

material: wood blank



Available in colours: 59, 61-65

Kassetta

HDF board, varnish, available only in matt



Available in colours: 1-58

Draggo

material: wood, veneer, MDF board, varnish, available only in matt



Available in colours: 2,3,7,12,20,29,50,52

Gladjo

material: wood blank



Available in colours: 59,61-65

Toretto

material: wood, veneer, MDF board, varnish, available only in matt



Available in colours: 2,3,7,12,20,29,50,52, 59, 61-65

01	snow white	11	tea colour	21	lavender	31	sesame	41	mokate	51	honey
02	white	12	pearl grey	22	patina	32	marble	42	seashell	52	beige pearl
03	magnolia	13	pigeons	23	coastal blue	33	lilac	43	oyster white	53	beige
04	latte	14	grey pearl	24	scandinavian	34	jasmine	44	cream	54	light beige
05	porcelain	15	grey	25	blue	35	cappucino	45	white cream	55	champagne
06	chalky white	16	light grey	26	atlantic	36	sand	46	orchid	56	aquamarine
07	light grey	17	grey meteo	27	l'azure	37	grey beige	47	delice	57	avocado
08	milk	18	stylish grey	28	azure	38	brown	48	rose	58	bottle green
09	parisian	19	graphite	29	ink	39	granite	49	pearl copper		
10	parchment	20	grey graphite	30	navy blue	40	black	50	porto		

59	bianco oak	61	ecru oak	63	mocha oak	65	chestnut oak
60	marzipan - * Elenore	62	honey oak	64	walnut	66	brown alder - * Elenore

SENTIMA FRONTS

Kasetta

material: MDF board, PVC foil
patinated version in option



Available in colours:
77-111

Tuzin Róż

material: MDF board, PVC foil
patinated version in option



Available in colours:
77-111

Pierwsza Miłość

material: MDF board, PVC foil
patinated version in option



Available in colours:
77-111

77	white super matt	88	marone	98	pacific	107	kobe matt
78	white canadian	89	sonoma oak	99	cobalt metallic	108	capri
79	white smooth	90	riviera oak	100	metallic titanium	109	green ontario
80	magnolia pearl	91	structure oak	101	dark oxid	110	grey loire oak
81	light grey matt	92	nature halifax oak	102	light oxid	111	black matt
82	alabaster matt	93	grey tisano oak	103	ferro		
83	mussel matt	94	tibero ash	104	grey steel		
84	acacia	95	tabac halifax oak	105	grey wolfram		
85	light beige	96	catania oak	106	mystical matt		
86	cashmere	97	wenge oak magic				
87	truffle matt						

L varnished front Q wooden front F veneered front

BODIES



grey graphite

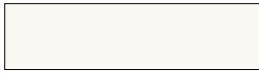

white alpine



black



mountain oak



chestnut



grey grenola



champagne



wenge

COUNTERTOPS

COLORS OF CUSTOM-MADE COUNTERTOPS



golden oak



lancelot oak



stone oak



stave oak oiled



mountain oak



lancelot grey oak



tabac oak



lincoln walnut



dark stave acacia oiled



old wood



wenge stave



chromix white



white cashmere



porfido crema



marble debesis



metropolitan



marble palatino



telesto



aris



travertine



tenerife



industrial



marcasite



gold caspio



brown ferro



golden granite



metal slate grey



grey ferro



marble valentino



district dark



porfido grafito



volcano



marble atira



ladabi



COFFEE & MILK

ESPRESSO	1.50
MACCHIATO	1.70
FLAT WHITE	1.80
CAPPUCCINO	1.90
LOTTE MACCHIATO	2.20
AMERICANO	1.80
CAFE LATTE	1.90
MILK SHAKES	2.50
TEA	1.50

38TH ELYSEE AVENUE WITH L1 HANDLE - BLACK MATT /
84TH BOARD AVENUE WITH L4 HANDLE - BROWN FERRO

MODERN

CABINET BODIES

DISH RACK CABINETS

UP TO 230 cm IN HEIGHT + CROWN MOULDING

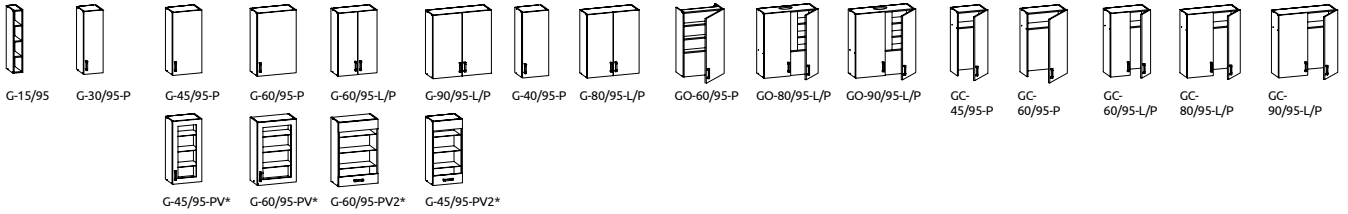

UP TO 207 cm IN HEIGHT + CROWN MOULDING

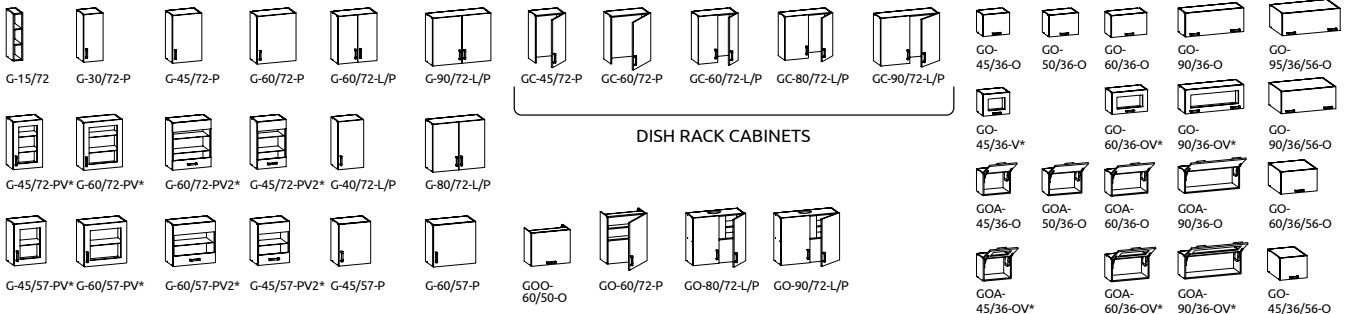

UP TO 82 cm IN HEIGHT + COUNTERTOP

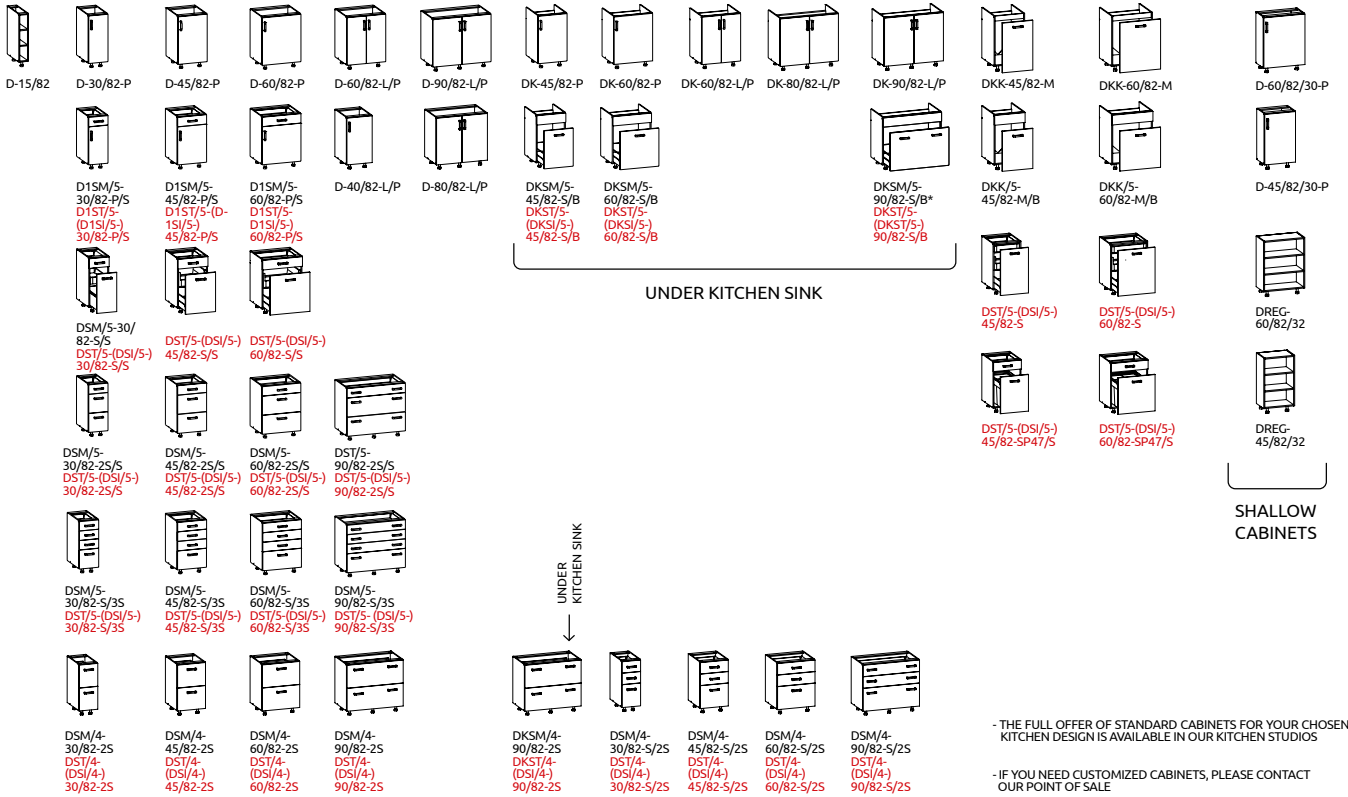

- THE FULL OFFER OF STANDARD CABINETS FOR YOUR CHOSEN KITCHEN DESIGN IS AVAILABLE IN OUR KITCHEN STUDIOS

- IF YOU NEED CUSTOMIZED CABINETS, PLEASE CONTACT OUR POINT OF SALE

CORNER CABINETS

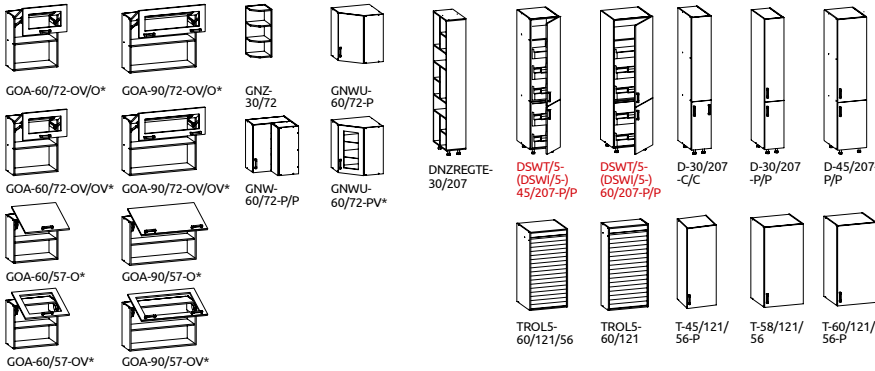
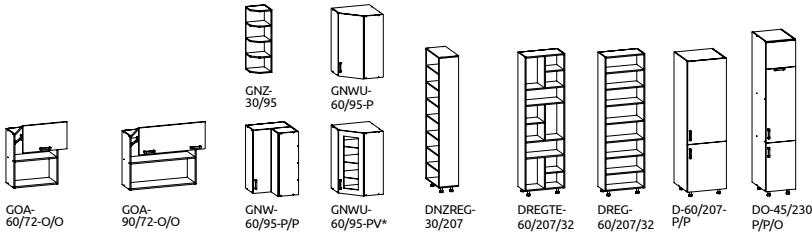

KITCHEN APPLIANCE CABINETS

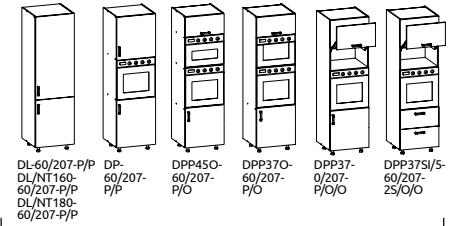
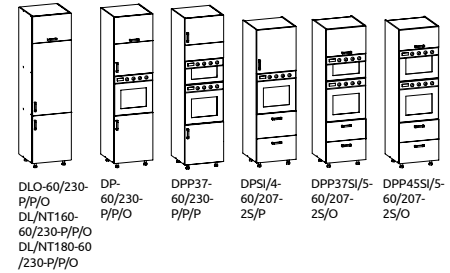

KITCHEN APPLIANCE CABINETS

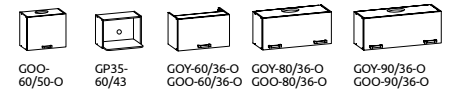

UP TO 136 cm in HEIGHT + COUNTERTOP

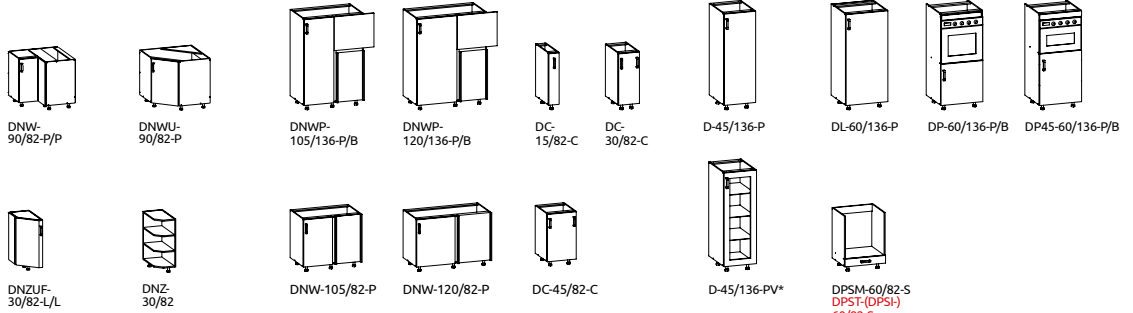

CORNER CABINETS

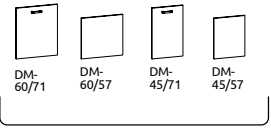

KITCHEN APPLIANCE CABINETS

CAPITAL

- 47th scott avenue
- 33rd saperavi avenue
- 38th elysee avenue
- 43rd luvak avenue
- 42nd marche avenue

- 32nd malbec avenue
- 36th norde avenue
- 47th scott avenue
- 49th cortese avenue

TRAFFIC

- 96th york street
- 84th board street
- 94th cortese street
- 87th smooth street
- 91st court street
- 97th west street
- 98th elysee street

* CHECK THE AVAILABILITY FOR YOUR CHOSEN KITCHEN DESIGN

CLASSIC

CABINET BODIES

DISH RACK CABINETS

UP TO 230 cm IN HEIGHT + CROWN MOULDING

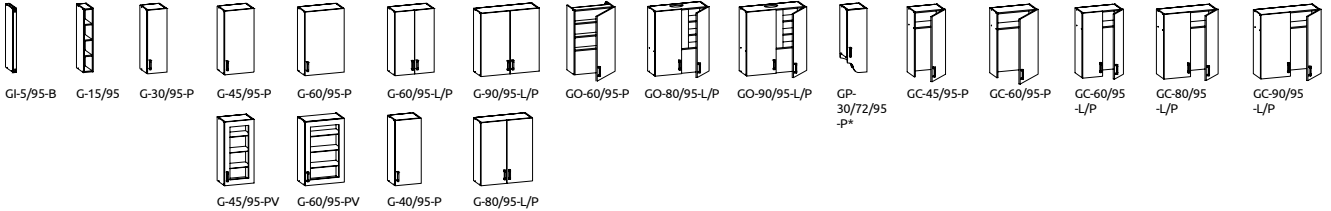

UP TO 207 cm IN HEIGHT + CROWN MOULDING

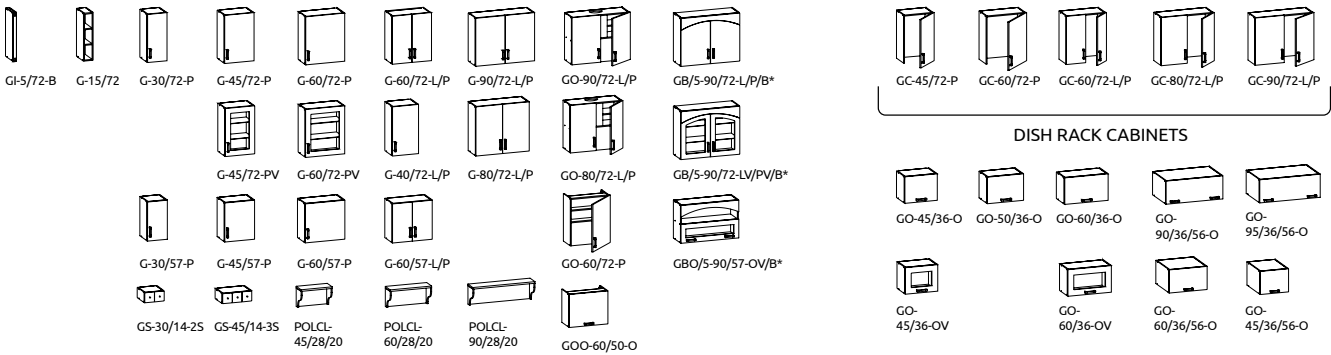

DISH RACK CABINETS

UP TO 82 cm IN HEIGHT + COUNTERTOP

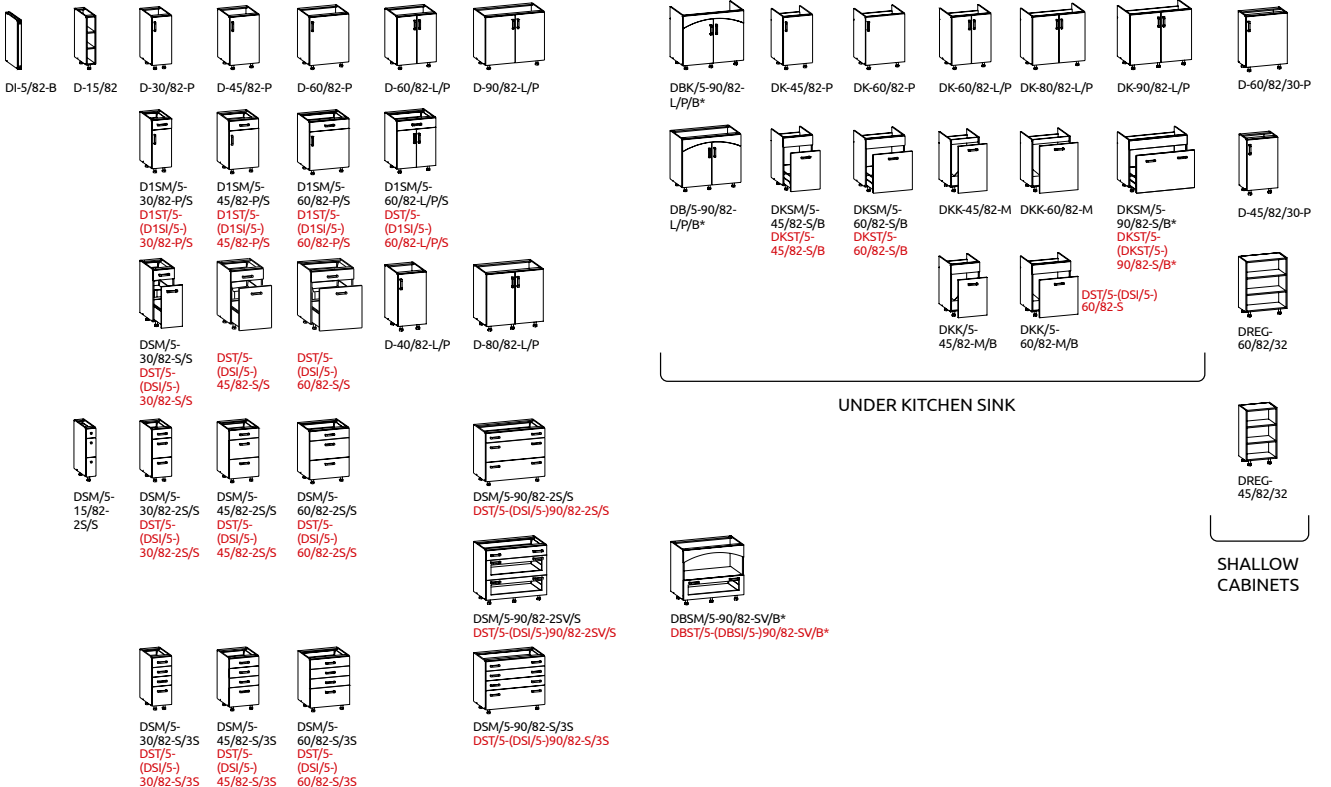

UNDER KITCHEN SINK

SHALLOW CABINETS

CORNER CABINETS

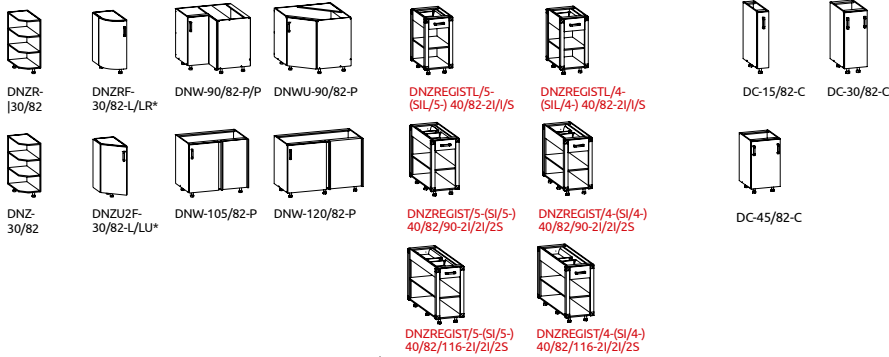
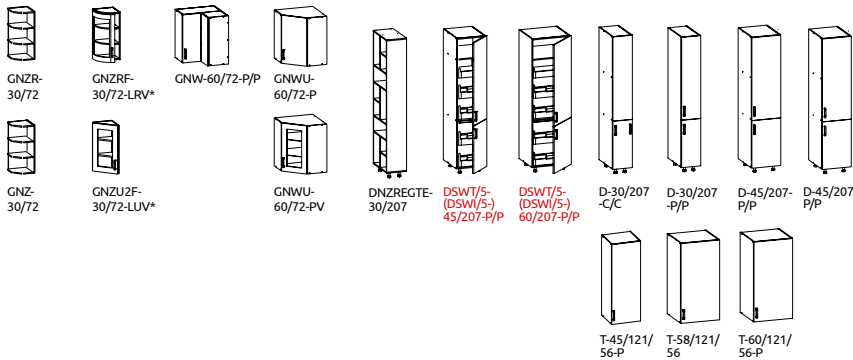
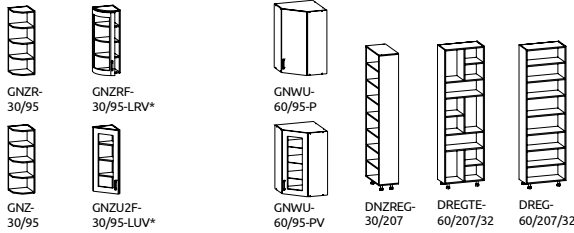

CORNER CABINETS

KITCHEN APPLIANCE CABINETS

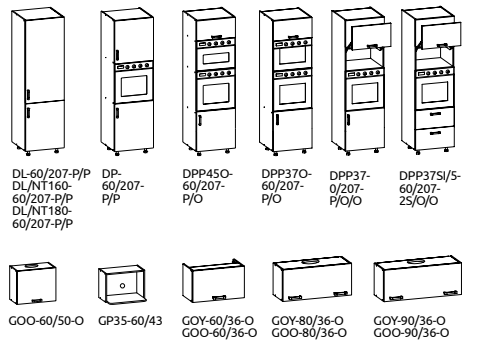
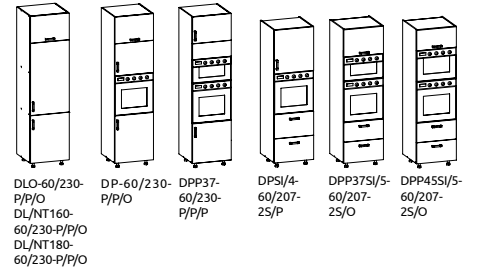

KITCHEN APPLIANCE CABINETS

ROYAL

Kasetta
Toretto
Frigg
Imperor
Gladio
Elenore
Draggo

SENTIMA

Kasetta
Pierwsza Miłość
Tuzin Róż

* CHECK THE AVAILABILITY FOR YOUR CHOSEN KITCHEN DESIGN

- THE FULL OFFER OF STANDARD CABINETS FOR INDIVIDUAL KITCHENS IS AVAILABLE IN OUR KITCHEN STUDIOS

- IF YOU NEED CUSTOMIZED CABINETS, PLEASE CONTACT OUR POINT OF SALE



**BLACK
RED
WHITE**

The information presented in the catalogue does not constitute an offer within the meaning of the Civil Code. All data available in the catalogue are valid for the month in which it was submitted for printing (12/2020). The dimensions of the furniture may be subject to minor changes, in which case the updated dimensions of the furniture will be provided on the brw.com website. All the dimensions given are external dimensions (including finishes). Due to the limitations resulting from the printing technique, the colours reproduced in the catalogue may differ from the actual colours of the furniture offered and the product range of interior furnishings. Most of the furniture presented in the catalogue is sold in self-assembly packages. Only correct installation of furniture, i.e. compliant with the instructions, guarantees satisfaction with its use. Individual goods may be withdrawn from the offer if they are not available from the manufacturer. The product range available at individual points of sale may vary.

Note: If you no longer need this catalogue, do not throw it away. Give it to someone who is interested. This way you will contribute to protecting the environment.

Black Red White S.A.
Krzeszowska 63
23-400 Biłgoraj
Poland

E-mail: export@brwsa.pl
www.brw.com