

# CENTER HUNG PIVOT SET, 500 LBS

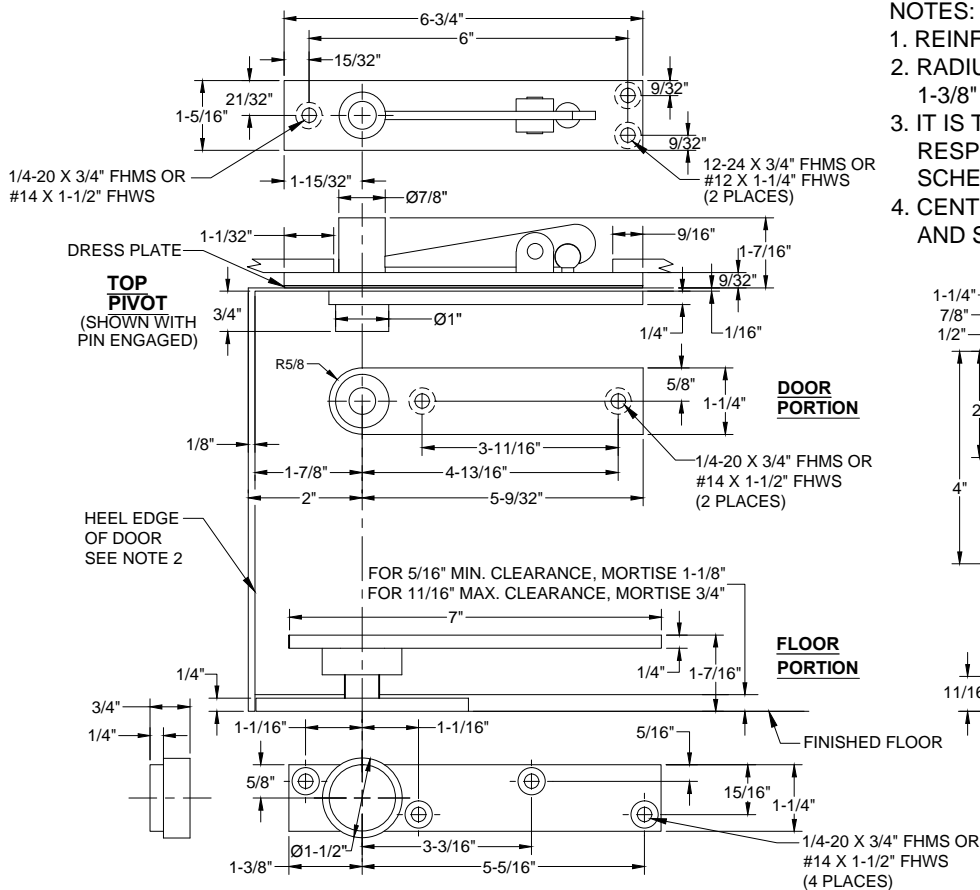

## NOTES:

1. REINFORCING BY OTHERS.
2. RADIUS HEEL EDGE OF DOOR 1-7/8" MAX FOR 1-3/8" TO 2-1/2" THICK DOORS.
3. IT IS THE DOOR AND FRAME MANUFACTURERS RESPONSIBILITY TO CHECK THE HARDWARE SCHEDULE AND PREP THE DOORS AND FRAMES.
4. CENTERLINE OF TOP PIVOT PIN MUST BE PLUMB AND STRAIGHT WITH BOTTOM PIVOT.

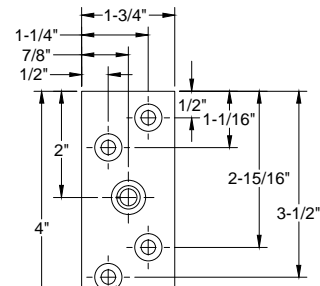

(4) 1/4-20 X 3/4" PHIL F.H., M.S. & (4) LEAD EXPANSION SHIELDS AS PROVIDED.

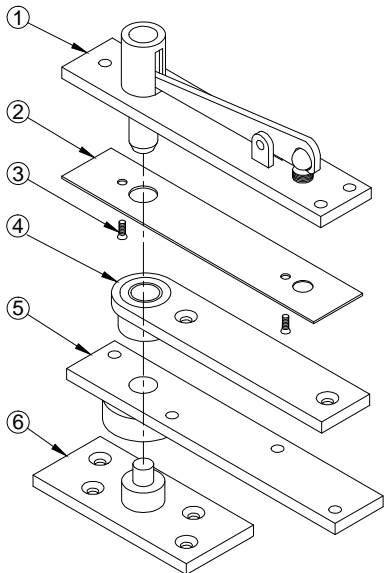
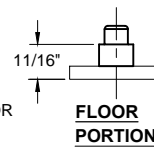

## INSTALLATION INSTRUCTIONS

1. MEASURE 2" OUT FROM DOOR JAMB ON CENTERLINE OF DOOR. THIS IS THE LOCATION OF SPINDLE CENTER.
2. RADIUS HINGE EDGE AND PREPARE DOOR FOR 1/16" MIN. CLEARANCE THRU ENTIRE OPENING.
3. INSTALL DOOR PORTION PER TEMPLATE.
4. INSTALL FLOOR PORTION PER TEMPLATE.
5. INSTALL DOOR PORTION PER TEMPLATE.
6. INSTALL JAMB PORTION PER TEMPLATE.
7. FASTEN DRESS PLATE TO JAMB PORTION.
8. CENTERLINE OF PIVOT SHOULD ALIGN WITH CENTERLINE OF BOTTOM SPINDLE. USE A PLUMB LINE TO ASSURE ACCURACY.
9. SET INSTALLED DOOR PORTION ON FLOOR PORTION SPINDLE.
10. ENGAGE THE TOP PIVOT PIN BY TURNING PIN RETRACTING SCREW CLOCKWISE.

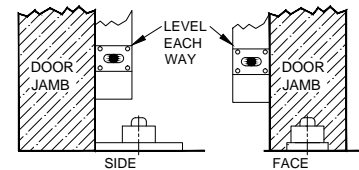
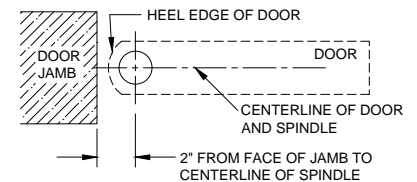

## DISMOUNT DOOR (IF REQUIRED)

1. OPEN THE DOOR ENOUGH TO DISENGAGE THE TOP PIVOT.
2. ROTATE THE DOOR TO CLOSED POSITION.
3. WITH THE TOP OF THE DOOR LEANING TOWARD YOU, LIFT THE DOOR CLEAR OF THE SPINDLE.

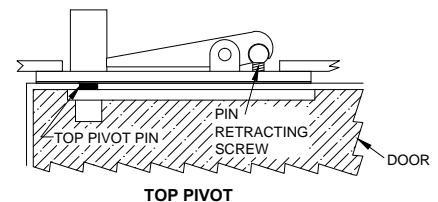

 **HardwareSource**

1 (858) 322-6353

www.HardwareSource.com

SKU: C10561