

**KYOTA**<sup>®</sup>

The World's Most  
Advanced Massage Chairs<sup>®</sup>

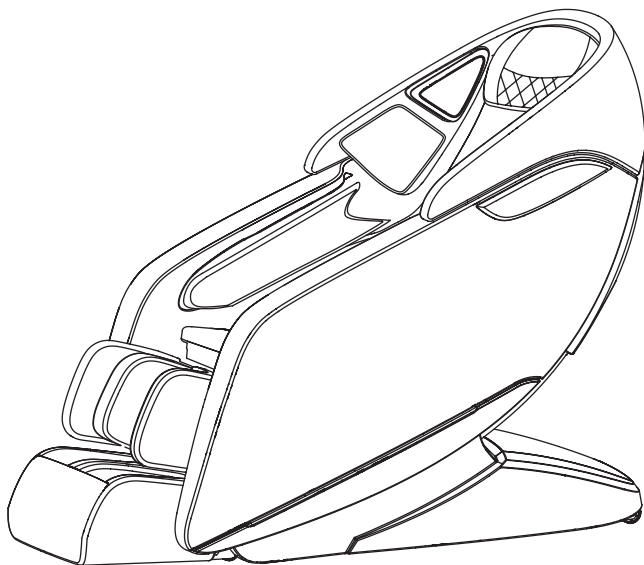

# User Manual

# Genki M380 Massage Chair

# Staying Safe

## Safety Information

To ensure safe use of the massage chair and avoid injury or unsafe conditions, please read and follow all instructions before using product.

### WARNING

---

#### USE NOT RECOMMENDED FOR CERTAIN PERSONS

Use of massage chair may not be safe or suitable for persons with certain medical conditions and could cause serious injury or death in some circumstances. If you have any of the following conditions, please consult a physician before using the massage chair:

- Use of implanted electronic medical devices (such as a cardiac pacemaker)
- Pregnancy
- Cancer, malignant tumors, or other growths
- Osteoporosis or spinal fracture
- Other fractures or musculoskeletal injuries
- Loss of or reduced sensitivity to heat
- Implanted medical fixation devices such as rods, pins, etc.
- Recent surgery or sutures
- Skin diseases or skin injury
- High fever
- Certain pulmonary or breathing conditions
- Impaired circulation

### WARNING

---

To avoid possible death or serious injury to user or others, please read and follow these instructions:

- **The areas under the footrest and behind the back rest are potentially dangerous for a child or pet. The chair back is heavy and reclines with force. A small child or pet located behind the chair could be crushed as chair is reclined resulting in serious injury or death. When chair is reclined, small children or pets who have crawled under the leg rest may not be visible to the user and could be crushed when leg rest is lowered or when chair is returned to upright position. To avoid serious injury or death, check these areas carefully before reclining, lowering leg rest, or returning chair to upright position.**
  - **Chair should not be used by children under age 14.** Small children could be trapped or injured by airbags, heating mechanism, or moving parts. When chair is not in use, unplug unit and secure chair so that children cannot accidentally power on and operate chair.
- Children over age 14, persons with reduced physical, sensory, or mental capabilities, and elderly or frail persons should exercise caution and use massage chair only when supervised or assisted by a person over 16 years of age.
- Chair has a heated surface and could cause burns, particularly in persons with reduced sensitivity to heat. Such persons should use the chair only after consulting with a physician and should use extreme caution during any physician-approved use.

## CAUTION

**To avoid the risk of minor injury or discomfort, or damage to the massage chair or other property, please read and follow these instructions for safe use of massage chair:**

---

- Do not stand or stack heavy objects on footrest.
- Do not operate heating features of chair while under a blanket or pillow. Excessive heating can occur and cause fire, electric shock, or injury to persons.
- To avoid pinching or crushing, please do not place body parts, especially fingers and toes, between parts of chair and keep clear of moving parts.
- To avoid overheating, injury or discomfort from overuse, do not fall asleep while using massage chair and do not use for extended periods of time (longer than 20 minutes).
- Avoid use while under the influence of alcohol, medications or other substances that may cause drowsiness, disorientation, or impairment of judgment or motor skills.
- Do not use the massage chair right after a meal, as it may cause discomfort.
- If you feel any abnormal discomfort during the operation of the massage chair, turn off the power immediately and discontinue use.
- Do not use this appliance when ambient temperature is over 40 C (104 F).
- Do not use this appliance in humid or dusty environment, or when any part of the body is in contact with plumbing or any similar ground.
- Never operate the appliance with the air openings blocked. Keep the air openings free of lint, hair, dust and the like.
- Do not use outdoors.
- Do not operate where aerosol (spray) products are being used or where oxygen is being administered.
- Place the product on a flat, level floor to reduce risk of tipping or overturning.
- Do not use or store near heat or open flame.
- Intended only for users who weigh below 300 lbs.
- Use this product only for its intended use as described in this manual. Do not use attachments not recommended by the manufacturer.
- Massage chair intended only for use by one person. Do not use by two or more persons at the same time to avoid damage to the product.
- Do not allow children to stand, jump, or play on or around massage chair, even when it is not powered on or in use.
- Remove personal accessories from arms and empty pockets while using the massage features of the chair.
- Check the upholstery under the cushions and other spots for damage or loose objects that may cause injury or damage chair while operating. If any damage is present, do not use the massage chair and refer to a qualified service professional for servicing.
- To avoid damage to chair, walls, or other objects, make sure there are no obstacles behind the chair and there is enough clearance before adjusting the backrest or leg rest angle.
- Please be seated properly while using the product.

# Staying Safe

- To avoid damage to chair or floors, do not drag or push the chair or roll its casters on wood floor or carpet. See instructions on p.6 for safely moving chair.
- If massage chair is not working properly, has been dropped or damaged, or has been dropped into water or exposed to flooding, return the appliance to a service center for examination and repair before attempting to use.
- Do not drop or insert any object into any openings in chair.

## **WARNING**

**Read and follow these instructions concerning safe use of the power cord and power unit to avoid possible electric shock, fire hazard, use of chair by and injury to unattended children, or damage to chair or other property.**

---

- To avoid risk of electric shock, connect this unit to a properly grounded outlet only. See Grounding Instructions on pg. 7.
- Always unplug massage chair from the electrical outlet immediately after use and before cleaning. An appliance should never be left unattended when plugged in. To disconnect, turn all controls to the off position, then remove plug from outlet.
- Do not use massage chair and unplug from outlet during thunder or lightning storms, and before putting on or taking off parts.
- To ensure safe operation, power must be supplied only at standard 110 voltage, to the specifications of the appliance. Confirm that the power voltage stated on the rating label corresponds to your local electricity supply.
- The massage chair should be used only with the power supply unit provided. Do not use with any other power source
- Do not use a wet or damp hand to unplug the cord to avoid electric shock.
- Do not pull on the power cord to unplug. Grip by plastic end nearest outlet to unplug power cord.
- Do not squeeze, over bend, pull hard, or twist the power cord. - Keep the power cord away from heated surfaces.
- Do not carry or drag the chair by power cord or use cord as a handle.
- If there is any smoke or unusual smell while using massage chair, stop using immediately and unplug the power cord.
- Never operate the chair if it has a damaged power cord or plug. If the power cord is damaged, it must be replaced by the manufacturer or its service agent or a similarly qualified person to avoid a hazard.

**Do not disassemble, dismantle or attempt to repair massage chair. Such actions, as well as misuse of product, may cause damage to or failure of massage chair and may void the manufacturer's warranty. For repairs, please contact an authorized dealer or repair agent at 603-910-5000. For additional details concerning terms, conditions and limitations of warranty, see <https://infinitymassagechairs.com/warranty-info>.**

# Your Chair

## External Structure

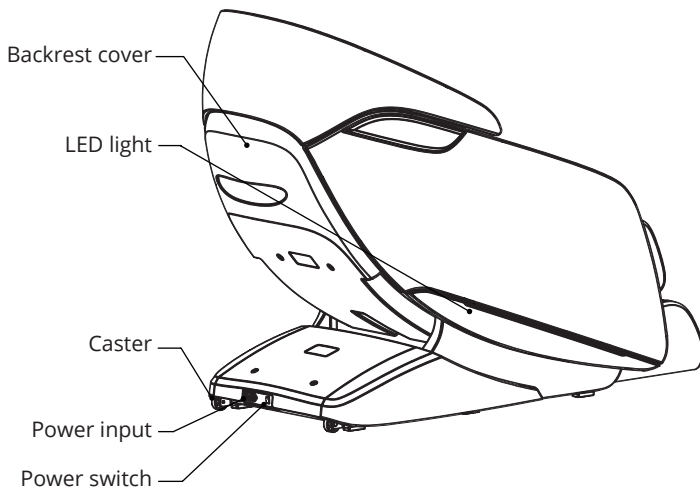

## Remote Control

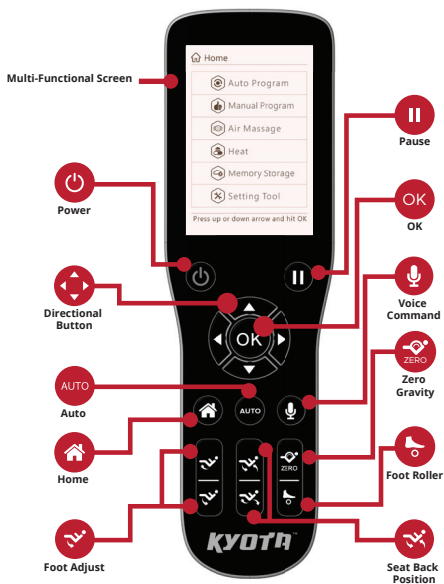



Welcome to

# KYOTA®

Thank you, and congratulations on purchasing your very own Kyota Massage Chair product - you've made a great buying decision. Welcome to the Kyota family.

Inside this manual, you will find everything you need to setup and safely enjoy your chair. Please review the entire manual before assembling or using your chair. If you are assembling the chair yourself, please see the Assembly Guide next and reference the online assembly video.

For convenience, we've also created a Quick Start Guide. We suggest you keep it in the remote pocket as a tool to get to know all the features of your new chair.

**Sit back, relax, and enjoy your new Kyota massage chair!**

## Warranty Registration

Register your product at [www.kyotamassagechairs.com/warranty/registration](http://www.kyotamassagechairs.com/warranty/registration) to ensure it is in our system. This will simplify the warranty process should you ever need it.

Alternatively, **scan the QR code** to go directly to the URL above.



SCAN CODE

## Assembly Video

Before assembling your chair, watch an assembly video at: [www.kyotamassagechairs.com/assembly-tutorials](http://www.kyotamassagechairs.com/assembly-tutorials)

Alternatively, **scan the QR code** to go directly to the URL above.



SCAN CODE

# Chair Features

- **43" L-Track**
- **Zero Gravity Recline**
- **Zero Wall Space-saving Technology**
- **Complete Calf™ kneading + Oscillation**
- **Bluetooth Technology**
- **Decompression Stretch**
- **Foot Reflexology Rollers**
- **TrueFit™ Footrest Extension**
- **USB Charging Port**
- **Lumbar Heat**
- **Truefit™ Body Scanning**
- **Four Wheel Massage Mechanism**
- **Airbag Compression Therapy**
- **Intelligent Voice Command + Control**
- **MyMassage™ Memory Programs**



# Table of Contents

<b>Staying Safe</b>	2	<b>Settings</b>	
<b>Staying Safe</b>	5	Timer	22
<b>Preparation</b>		LED Lights	22
Installation Site	10	Language	22
Clearance Space for the Chair	10	Bluetooth Audio	23
Floor Protection	10	Remote Control Beep	23
Move Methods	11	Sleep Mode	23
Connect to Power	12	Remote Control In-use Screen	23
<b>Chair Setup</b>		<b>Create a Massage</b>	
Main Power Switch	12	Manual Programs	24
Adjust Pillow	12	Massage Mode	24
Truefit™ Body Scanning	13	Massage Position	24
Re-adjust Shoulder Position	13	Massage Speed	25
Getting out of the Chair	13	Massage Width	25
Chair Entry and Exit Hazards	14	Foot Rollers	25
USB Charging Port	15	Calf Rollers	25
<b>Getting Started</b>		<b>Fixing Issues</b>	
Auto Programs	16	Troubleshooting	26
Airbag Massage	18	FCC Information	26
Airbag Region	18	Frequently Asked Question	27
Airbag Intensity	18	Specifications	27
Back Heat	19		
Foot Rollers	19		
Calf Rollers	19		
Intelligent Voice Command + Control	20		
MyMassage™ Memory Programs	21		

# Preparation

## Installation Site

### Clearance Space for the Chair

- 2" clearance for the recline of the backrest; 14" clearance for the extension of footrest and sliding forward of the chair.
- Keep it 3 feet away from the TV, radio or other audio & video appliance to avoid signal interference.

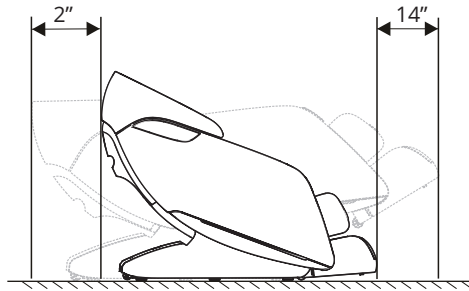

- Keep the distance between the power socket and power switch within 60" to avoid damage of power cord while massage chair sliding forward.
- Straighten the power cord while in use to avoid tangle or damage.
- When the massage chair sliding forwards or back, please check to make sure there is no children, pets or other obstacles around to avoid accident.

## Floor Protection

We recommend to place a piece of thin carpet or soft mat underneath it to avoid damaging the floor.

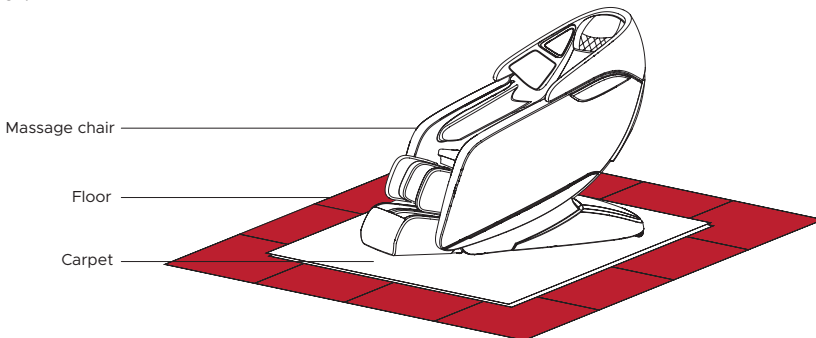

- Do not use the massage chair in high moisture environment such as near swimming pool or bathroom to prevent electric shock accident.
- Please keep the massage chair away from heated surfaces to prevent fire hazard or damage to the product.

## Move Methods

- Apply pressure to the back of the massage chair from behind to pivot on the Castors. Have a second person up front to guide the Footrest until in the correct position. Maintain clearances as mentioned above. Gently lower into place. Do not pull on the side arms.

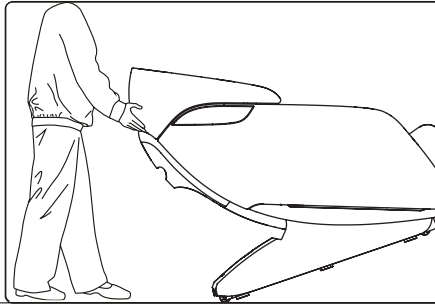

- Do not move the chair when there is a user inside.
- To carry this product, do not lift by the footrest or armrest, hold the chassis and steady the backrest (have 4 or more people to carry the product).

## Connect to Power

Plug into a 110V grounded outlet.



**WARNING**

### Grounding Instructions

To avoid risk of electrical shock, turn power switch off before plugging unit into electrical outlet. Use only with properly grounded outlet (3 prong). Do not plug into ungrounded outlet.

**WARNING** – Improper connection of the equipment-grounding conductor can result in a risk of electric shock. Check with a qualified electrician or serviceman if you are in doubt as to whether the product is properly grounded. Do not modify the plug provided with the product – if it will not fit the outlet, have a proper outlet installed by a qualified electrician.

This product is for use on a nominal 120-V circuit and has a grounding plug that looks like the plug illustrated. Make sure that the product is connected to an outlet having the same configuration as the plug. No adapter should be used with this product.

### Earthing

This massage chair is a Class 1 electrical appliance. Make sure to use a grounded outlet to the grounded power supply circuit and a properly installed earth grounding rod with ground connection, to avoid electric shock.

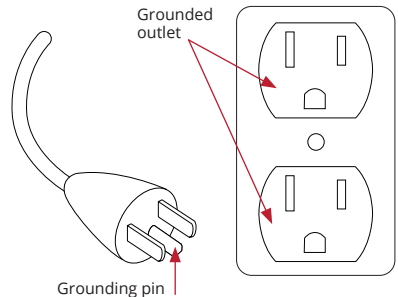

# Chair Setup

## Getting Comfortable

### Main Power Switch

To power up the chair, flick the main power switch located on the back of the base of the chair to **ON**.

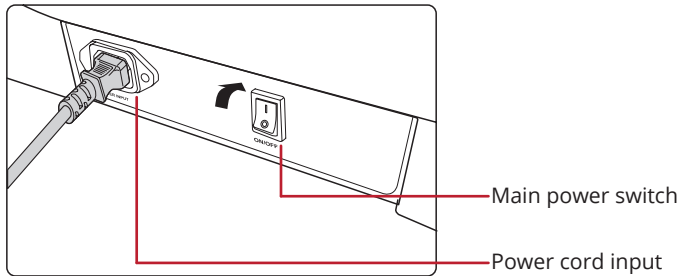

- Children should be supervised to ensure that they do not play with the chair or touch the power box.
- Always unplug the massage chair from the electrical outlet immediately after use.
- Unplug from outlet during thunder or lightening storms, and before putting on or taking off parts.
- Turn off the power switch and unplug the massage chair from the electrical outlet while not in use to avoid children power on the massage chair accidentally.
- When not in use for a long period of time, we recommend that the chair be covered, the power cord be coiled and that the unit be placed in an environment free of dust and moisture.

### Adjust Pillow

Take a seat in the chair and take note of where the neck pillow rests on your neck. Adjust the pillow so that it rests comfortably in the arch of your neck. Do this by removing it from the velcro, aligning it, and then reattaching to the velcro once it is in the desired position.

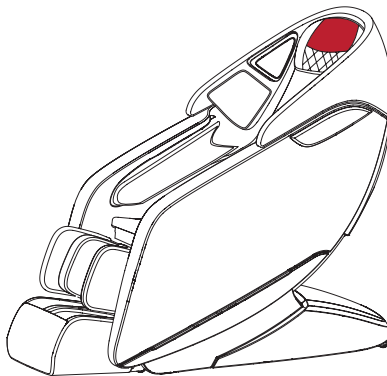

## Truefit™ Body Scanning

Select any auto program and press the **OK** button. The chair will automatically begin scanning your body, mapping your back, shoulders, and neck. During this process it is important to remain seated back into the chair without lifting your head.

The scan can be viewed on the remote control screen. If fine tuning is needed just after your body scan, wait for the **shoulder adjust prompt** to appear and then use the **Back Adjustment** buttons to move the massage rollers up or down for the perfect shoulder kneading position.

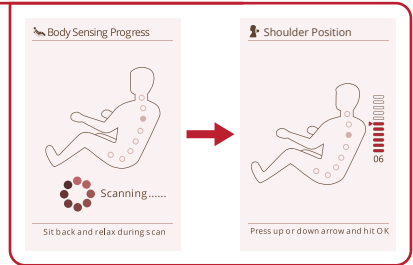

## Re-adjust Shoulder Position

If you find that you need to adjust your shoulder height position after leaving the shoulder adjust screen, simply use the left and right arrows when in the in-use screen to navigate to **shoulder position**. Press OK to select. Once selected you will be taken back to the Shoulder adjust screen where you can use the up and down arrows to fine tune your shoulder position.

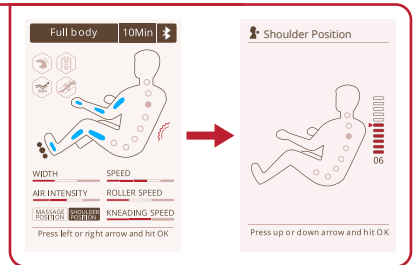

## Getting out of the Chair

To easily exit the chair at any time, press the **ON/OFF** power button on the remote control to restore the chair to the upright position.

**WARNING!** Check to make sure children and pets are clear of chair **before** pressing on/off button to return chair to upright position. See next page for detailed hazard warnings.



# Chair Setup

## Chair Entry and Exit Hazards

**WARNING!** The areas under the footrest and behind the back rest are potentially dangerous for a child or pet. The chair back is heavy and reclines with force. A small child or pet located behind the chair could be crushed as chair is reclined resulting in serious injury or death. When chair is reclined, small children or pets who have crawled under the leg rest may not be visible to the user and could be crushed when leg rest is lowered or when chair is returned to upright position. **To avoid serious injury or death, check these areas carefully before reclining, lowering leg rest, or returning chair to upright position.**

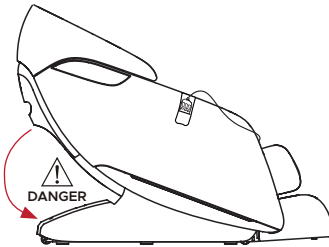

Make sure to check for children or pets **between the chair back and the base of the chair** before entering zero gravity recline.

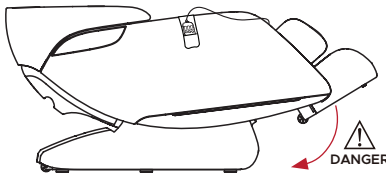

Make sure to check for children or pets **underneath the footwell** before exiting zero gravity recline and returning to upright position.

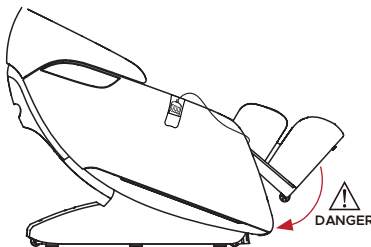

Make sure to check for children or pets **between the footrest and the chair body** before lowering the legrest.

# USB Charging Port

Another feature of your chair is an in-built USB port for charging your devices. The USB charging port can be found on the left hand side of the seat opposite the remote cord.

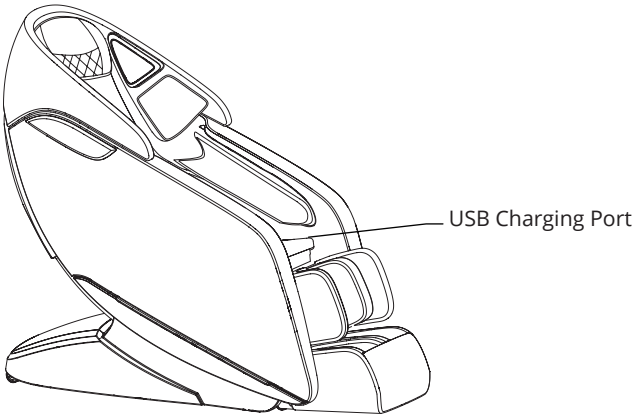

# Getting Started

## Auto Programs

When massage chair is operating, press the **AUTO** button on the remote control to enter Auto Program Menu. Choose from **Quick, Full Body, Rest & Relax, Recharge, Recovery, Stretch, Neck & Shoulder, Back Relief, Lower Body, Stress Relief, Renew, and Athlete**. Press **OK** to enter the program you desire. Selected program will show on the home screen.

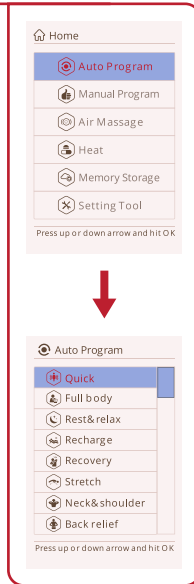

## Navigating the remote

*To show the Auto Programs list:* Use the directional buttons to highlight **AUTO PROGRAM** from Home display, press **OK** button to select. Press up or down button to navigate amongst the 12 auto programs.

*To select an auto program:* Use the up and down directional buttons to highlight the program you wish to run. Press **OK** button to select and begin program.



## Programs

## Icon

Quick



Full Body



Rest & Relax



Recharge



Recovery



Stretch



Neck & Shoulder



Back Relief



Lower Body



Stress Relief



Renew



Athlete





## What for?

## Description

A quick way to feel all the massage techniques and chair movements in a brief 8 minute session.

Rapid demonstration of all massage techniques and chair motions.

This program is the best choice to relax tired muscles and increase physical vigor.

Comprehensive massage session using deep tissue kneading, and tapping.

Best for winding down and re-energizing yourself after a long day.

Inspired by Thai massage. This strong kneading and shiatsu massage effectively decompresses the entire body.

Recharge and re-vitalize your tired muscles after physical exertion.

Uses moderate pressure to decrease recovery time after physical exertion, relieve the body of stress and improve circulation.

Helps to relax and recover the main back muscles along your spine.

Assists in relieving lower and upper back pain through a series of massage techniques.

Designed for morning or midday relaxing.

Yoga like stretching motions combined with deep shiatsu massage helps to boost the vitality of muscles.

Soothing pain and tension in the neck and shoulders.

A sequence of neck, shoulder, and upper back massage techniques.

This program is recommended to relieve lower back pain.

Focuses on the lumbar vertebra with targeted kneading and tapping massage to relieve tension.

Alleviate tension in the lower half of the body.

Targets the lower back, buttocks and feet.

Reduce built up tension carried in the body from everyday stress.

Designed to help minimize stress carried in the neck, shoulders, lower back, and feet.

Relieving lower and upper back pain.

Assists in relieving lower and upper back pain through focused kneading of the hip area.

Try this program after sports activities and exercise.

Featuring neck, back, and waist kneading this massage relaxes muscles, improves circulation and aids in recovery.

# Getting Started

## Airbag Massage

Select **AIR MESSAGE** from Home display, press up or down button to navigate among: **POSITION** and **INTENSITY**.

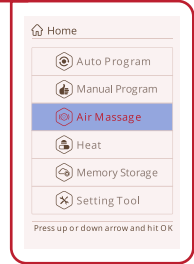

## Airbag Region

Navigate to **POSITION**, press right button, then use the up or down button to select your desired airbag region: Full Body, Upper Body, or Lower Body. Press **OK** button to select the airbag region.



## Airbag Intensity

Navigate to **INTENSITY**, press right button, then use the up or down button to select your desired intensity: 1 = light, 2, 3, 4 = firm, or Off. Press **OK** button to select the airbag intensity.



## Back Heat

Select **HEAT** from Home display, press right button, then press up or down button to navigate to desired heat level: 1 = low, 2, 3 = high, or OFF. Press **OK** button to select the heat level.

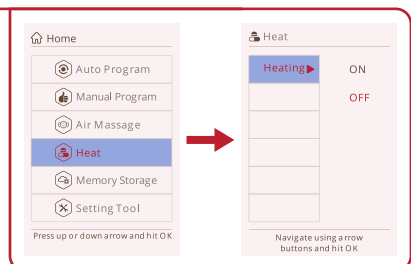

## Foot Rollers

Select **MANUAL PROGRAM** from Home display, press right button, then use the up or down button to navigate to **FOOT ROLLERS**. Press right button, then use the up and down buttons to select your desired foot roller speed: 1 = slow, 2, 3 = fast, or Off (deactivate foot roller). Press **OK** button to select the speed level you desire.

Alternatively, press the **Foot Roller button** on your remote control. Pressing this button will turn off Foot rollers, press again to also turn off Calf rollers, press again to resume both. Your current foot roller speed is displayed in the in-use screen in the top left corner.

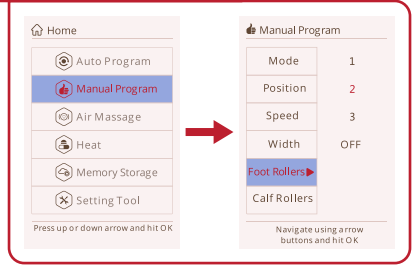

## Calf Rollers

Select **MANUAL PROGRAM** from Home display, press right button, then use the up or down button to navigate to **CALF ROLLERS**. Press right button, then use the up and down buttons to select your desired calf roller speed: 1 = slow, 2, 3 = fast, or Off (deactivate foot roller). Press **OK** button to select the speed level you desire.

Alternatively, press the **Foot Roller button** on your remote control. Pressing this button will turn off Foot rollers, press again to also turn off Calf rollers, press again to resume both. Your current foot roller speed is displayed in the in-use screen in the top left corner.

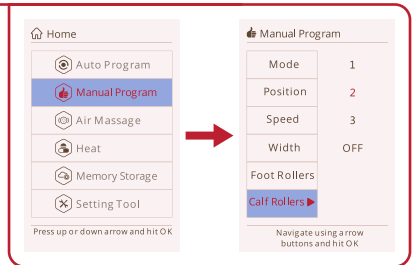

# Getting Started

## Intelligent Voice Command + Control

Your chair comes with built in intelligent voice command + control. This feature allows you to control your chair and massage experience completely hands-free by using one of the many voice commands. Voice Control will only work when the chair is powered on and active or within 20 minutes of an auto program ending.

To activate the intelligent voice control function, simply say **'Hey Kyota'**, pronounced **'Key-oh-ta'**, or press the voice control button on the remote control. You may now give your chair any of the commands below **within 6 seconds**. Make sure to speak clearly and slowly. After 6 seconds the Intelligent Voice Command function will turn off automatically and must be awakened again.

You can also activate intelligent voice control by using the remote control. Press the **Voice Command button** on your remote control, once to awaken Voice Command, or hold down for 4 seconds to turn off voice control listening.



### Turn Off Listening

At any time, Simply **press and hold the Voice Command button** for 4 seconds then release. Turn back on by pressing the Voice Command button again.

### Commands

"Quick"	"Lower Body"
"Full Body"	"Stress Relief"
"Rest and Relax"	"Renew"
"Recharge"	"Athlete"
"Recovery"	"Turn Chair OFF"
"Stretch"	
"Neck & Shoulder"	
"Back Relief"	

### Manual Commands

"Change to Point Mode"
"Go a Little Down"
"Go a Little Up"

## MyMassage™ Memory Programs

Your chair has the ability to save your favorite customized massage programs to memory.

To create a custom memory setting you first need to set up the chair for what it is you want to record. To do this, create a manual massage program with all of your desired air, heat, speed, and intensity settings.

To save a massage program, select **MEMORY STORAGE** from Home Display, press up or down button to navigate to: Memory 1, Memory 2 or Memory 3. Press right button, then press **OK** button to save the current massage settings to memory.

Once a memory program is saved it will show Saved in Red. If you hit save in a position with a program already saved, it will record over the previous setting. To run a memory program, select that program from the bottom of the Auto Programs Menu.

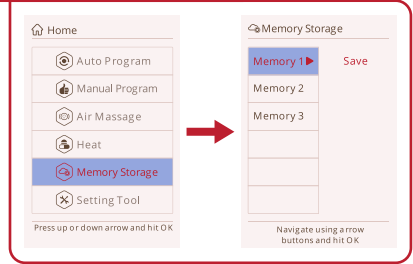

# Settings

## Setting Tool

Select **SETTING TOOL** from Home display, then use the up or down button to toggle between **TIMER**, **LANGUAGE**, **BLUETOOTH**, or **BEEP**.

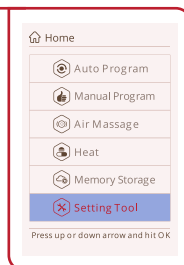

## Timer

Navigate to **TIMER**, press right button, then press up or down button to select your desired timer: 10 minutes, 20 minutes, or 30 minutes. Press **OK** to select your desired massage timer length. 20 minutes is the default setting.

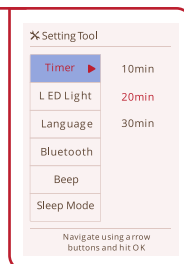

## LED Lights

Navigate to **LED LIGHT**, press right button then press up or down button to select your desired LED light setting: On or Off. Press **OK** to select LED light setting.

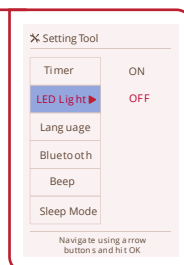

## Language

Navigate to **LANGUAGE**, press right button, then use the up or down button to select your desired language: ENGLISH, CHINESE, VIETNAMESE, or KOREAN. Press **OK** button to select language.



## Bluetooth Audio

Your massage chair includes Bluetooth compatibility so you can play and enjoy your favorite music. To turn on your chair's Bluetooth, navigate to **BLUETOOTH**, press right button, then press up or down button to select your desired Bluetooth setting: On or Off. Press **OK** button to select Bluetooth setting.

Open Bluetooth from audio device and pair with **M380 Genki** to play music.

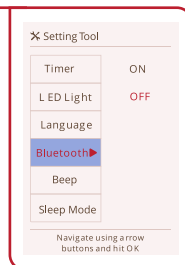

## Remote Control Beep

Navigate to **BEEP**, press right button, then use the up or down button to select your desired remote control beep function: On or Off. Press **OK** button to select beep function.

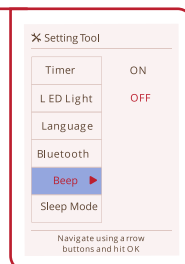

## Sleep Mode

Navigate to **SLEEP MODE**, press right button, then use the up or down button to select your desired sleep mode setting: On or Off. Press **OK** button to select beep function.

When sleep mode is **on** the chair will stop in the reclined position after Auto Programs, when sleep mode is **off** the chair will return to a fully upright position after each Auto Program.

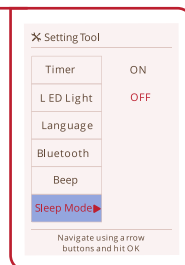

## Remote Control In-use Screen

Whilst running an Auto Program or Manual mode, the remote control screen will return to the in-use screen (as shown below) **after 10 seconds of being idle**. To return to the In-use screen from any menu screen, without waiting, simply press the left button until you return.



- Please do not spill water or other liquids in order to avoid key malfunctions and error codes.
- Please do not place heavy objects on the controller or power cord.

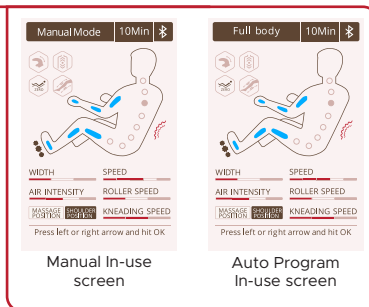

# Create a Massage

## Manual Programs

Select **MANUAL PROGRAM** from Home display, press up or down button to navigate among: **MODE**, **POSITION**, **SPEED**, **WIDTH**, **FOOT ROLLERS**, and **CALF ROLLERS**.

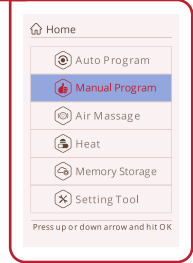

## Massage Mode

Navigate to **MODE**, press right button, then use the up or down button to select your desired mode: 360° Knead, Clockwise Knead, Counter-Clockwise Knead, Upper Knead, Lower Knead, Tap, Knead&Tap, Shiatsu, and Knock. Press **OK** button to select mode.

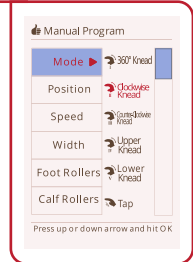

## Massage Position

Navigate to **POSITION**, press right button, then use the up or down button to select your desired massage position: Full, Upper, Lower, Partial, and Spot. Press **OK** button to select position.

**Full** travels the entire length of the massage track.

**Upper** travels from the neck down to lumbar.

**Lower** travels along the lumbar and glutes.

**Partial** travels a few inches above and below the current position.

**Spot** stops the massage mechanism in current position.

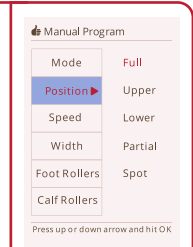

Partial and Point location can be fine tuned from the **in use screen**. Use the left or right button to navigate to **massage position**. Press OK to select. Once in the massage position menu screen, use the up or down buttons to move the massage mechanism up or down along your back. Holding the up or down button will cause the mechanism to move faster. Press OK to confirm changes.

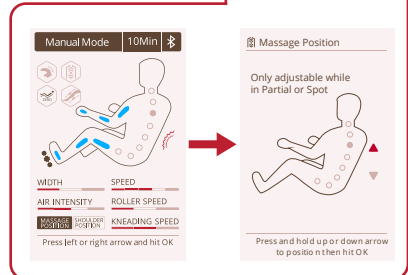



## Massage Speed

Navigate to **SPEED**, press right button, then use the up or down button to select your desired speed: 1 = slowest, 2, 3, 4, 5 = fastest. Press **OK** button to select the speed. (Massage speed can only be adjusted when in manual mode).



## Massage Width

Navigate to **WIDTH**, press right button, then use the up or down button to select your desired roller width: Wide, Medium, or Narrow. Press **OK** button to select width. (Massage Width only works in tap shiatsu and knock techniques).



## Foot Rollers

Navigate to **FOOT ROLLERS**, press right button, then use the up or down button to select your desired foot roller setting: 1 = slowest, 2, 3 = fastest, or Off (deactivate foot rollers). Press **OK** button to select the foot roller setting.



## Calf Rollers

Navigate to **CALF ROLLERS**, press right button, then use the up or down button to select your desired calf roller setting: 1 = slowest, 2, 3 = fastest, or Off (deactivate calf rollers). Press **OK** button to select the calf roller setting.



# Fixing Issues

## Trouble Shooting

Symptoms	Possible Causes	Possible Solution
Noise is heard while in use	These noises are normal and arise from friction between the massage rollers and the leather cover	No need to take any measures
Massage Chair does not start	The power cord is not secured into the socket Not switched ON The fuse is blown	Insert the power plug properly into the power socket Turn on the switch found on chair side. Then push power button on remote Replace only with a fuse of same type and rating
No music comes from the speaker	The volume is turned to the lowest setting	Adjust the speaker volume from the mobile device. Make sure Bluetooth setting on chair and phone are both ON
Backrest or footrest can not raise or recline	Excessive load has been pressed on the backrest or legrest	Replace the load and try again
Airbag malfunction	The air hose is blocked	Straight the air hose and clear out the blockage
Pause and Chair Adjustment Buttons are disabled	Chair is in the Demo Program	Exit the Demo by selecting another program, or by hitting the power button.

## FCC Information

This device complies with part 15 of the FCC Rules. Operation is subject to the following two conditions: (1) This device may not cause harmful interference, and (2) this device must accept any interference received, including interference that may cause undesired operation. Changes or modifications not expressly approved by the party responsible for compliance could void the user's authority to operate this device.

**NOTE:** This equipment has been tested and found to comply with the limits for a Class B digital device, pursuant to part 15 of the FCC Rules. These limits are designed to provide reasonable protection against harmful interference in a residential installation. This equipment generates, uses, and can radiate radio frequency energy and, if not installed and used in accordance with the instructions, may cause harmful interference to radio communications, however, there is no guarantee that interference will not occur in a particular installation. If this equipment does cause harmful interference to radio or television reception, which can be determined by turning the equipment off and on, the user is encouraged to try to correct the interference by one or more of the following measures:

- Reorient or relocate the receiving antenna.
- Increase the separation between the equipment and receiver.
- Connect the equipment into an outlet on a circuit different from that to which the receiver is connected.
- Consult the dealer or an experienced radio/TV technician for help.

## Frequently Asked Questions

### Q: I find the chair is too intense to be comfortable. What can I do?

**A:** Your body needs to become acclimated to therapeutic massage. To be effective, the massage techniques must compress the tissue in your body. We recommend the following steps to help get started. Then over time as your body acclimates you can increase the intensity by reducing the layers between you and the chair.

1. Use the body pillow and pillow pad to reduce upper body intensity
2. Go into Airbag on the main menu, select air intensity setting 1
  - If a specific airbag is too intense, turn off Full and turn only the airbags you want
3. Press the foot roller button until you feel the foot rollers turn off
4. Adjust the recline on the remote. More upright will be less intense. Zero Gravity will be more intense

### Q: I'm not a foot massage person, what should I do?

**A:** Turn off foot rollers, press the **Foot Roller button** on your remote control until the rollers stop. You may also want to turn off the Foot/Calf airbags or reduce the air intensity to level 1.

### Q: My chair is not performing as expected. What should I do?

**A:** Your Kyota massage chair is an amazing combination of programming and robotics. On occasion the chair just may need to be rebooted. To do this power down the chair and unplug from the wall for 5 minutes then plug back in and power back up to see if it self-healed. If you are still having an issue, give Kyota a call at 800-242-0761.

## Specifications

<b>Model</b>	Genki M380
<b>Dimension of Main Body (in)</b>	53 x 29.5 x 45 (L x W x H)
<b>Necessary Clearance to Wall (in)</b>	4"
<b>Net Weight (lbs)</b>	185
<b>Shipping Weight (lbs)</b>	367
<b>Max. User Weight (lbs)</b>	305
<b>Voltage</b>	120V
<b>Fuse</b>	1.25 AMP
<b>Power Consumption</b>	150W
<b>Safety Standards</b>	Type 1

**KYOTA<sup>®</sup>** | **The World's Most  
Advanced Massage Chairs<sup>®</sup>**

72 Stard Road, Seabrook, NH 03874

Toll Free #: (800) 242-0761

[www.kyotamassagechairs.com](http://www.kyotamassagechairs.com)

Version 1.10