



ELBA

ELECTRIC OVEN

MODEL: EEO-J6091D(BK)

Owner's Manual

Please read this manual carefully before operating your set.

Retain it for future reference.

Record model number and serial number of the set.

See the label attached on the set and quote this information to your dealer when you require service.

For The Warranty Terms & Conditions, Please Refer To Warranty Certificate.

IMPORTANT SAFEGUARDS

When using this appliance, basic safety precautions should always be followed, including the following:

1. All safety and operating instruction should be read before operation and user manual should be retained for future reference.
2. This appliance is for household use only, do not use outdoors.
3. This appliance is not intended to be used by persons (including children) with reduced physical, sensory or mental capabilities, or lack of experience and knowledge, unless they have been given supervision or instruction concerning use of the appliance by a person responsible for their safety.
4. Do not operate the appliance with a damaged power cord or plug or after the appliance malfunctions, or it is dropped or damaged in any manner. Return the appliance to the nearest authorized dealer or after-sales service centre for examination, repair or mechanical adjustment.
5. Never leave the oven unattended while broiling or toasting.
6. Do not cover any parts of the oven with metal foil curtains, cloths, wall as it will cause fire easily.
7. Oversized foods or metal utensils must not be inserted into the oven as it may cause fire or the risk of electric shock.
8. Never use any accessories or parts that ELBA does not specifically recommend.
9. Do not store any items such as cardboard, plastic, paper, etc. into the inner oven other than its recommended accessories.
10. Do not let the power cord hang over edge of table or hot surface.
11. To protect against electric shock, do not immerse power cord, plug, or the product body of the appliance in water or any other liquids.
12. Extreme caution must be used when handling or disposing of hot oil or other liquids.
13. Unplug the plug from wall outlet when not in use.
14. Place the cables in a safe manner to avoid slips, trips, and falls.
15. Do not remove or lift the oven while the power cord is connected the wall outlet.
16. Do not operate the appliance with an external timer.
17. Do not carry the appliance during operation.
18. If you are not using the product, adjust the Timer and Temperature to OFF position and disconnect the power cord from the wall outlet.
19. Do not place the appliance on or near the gas or electric burner, or in a heated oven.
20. Do not attempt to open the product. Unauthorized repair of the appliance may result in an electrical shock or damage to the product and will void your warranty.
21. Recommended to pre-heat the appliance before using it.

CAUTIONS

Always wear protective insulated oven gloves when inserting and removing foods from the oven.



Do not apply water to the door glass right after use as it may cause the glass to break.

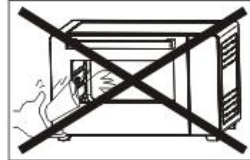

To remove the plug from the wall outlet, grasp the plug and not the power cord!



Do not place the appliance on or near the gas or electric burner, or in a heated oven.



Do not place anything on top of the oven while operating as it will cause deformation, cracking and etc.



Any bottled or tinned food cannot be heated directly under the oven or tin would cause broken and scald.

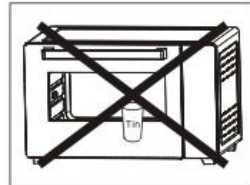

Beware! While operating the appliance, the product surface will be very hot, use only the door handle or knobs. Let the oven to cool down before removing any parts of the oven for cleaning.

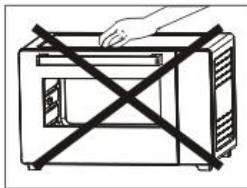

Insert the plug properly until it sits nicely on the socket. Do not connect multiple plugs to the same outlet!

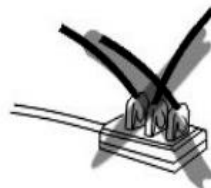

It is recommended to insert 2 sheets of aluminum foils to cover the chicken (as per following picture) placed on the baking tray in order to avoid oil splashing.



PRODUCT DESCRIPTION

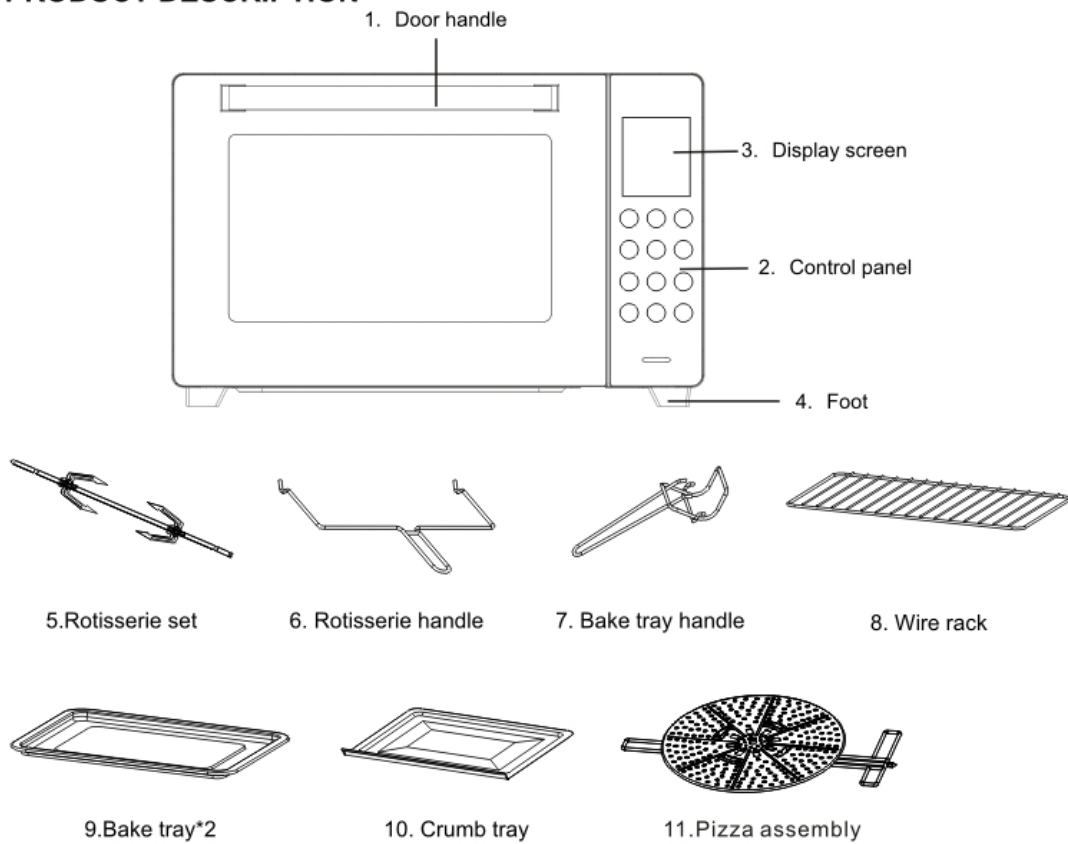

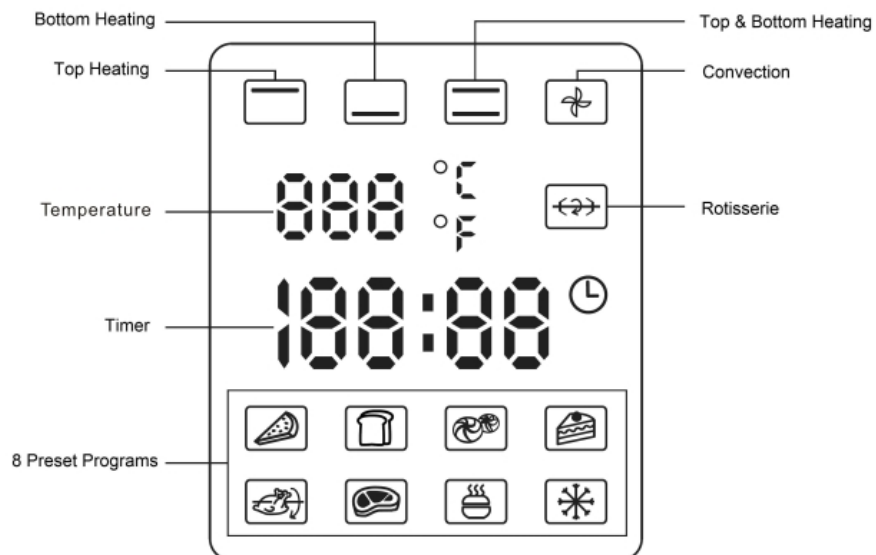

CONTROL PANEL LED DISPLAY



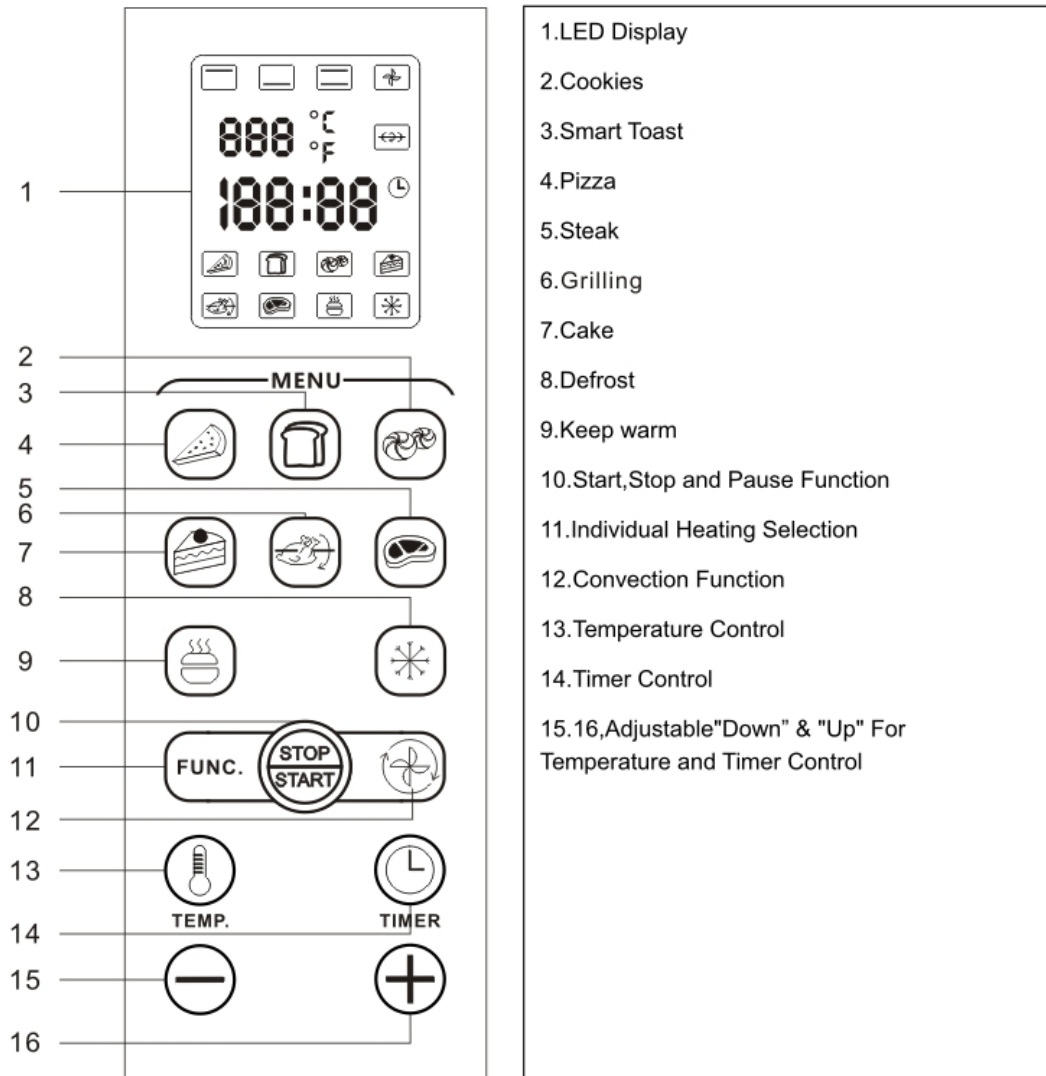



CONTROL PANEL GUIDE



Remark: This icon  will display only when you selected Roast Chicken function  and Pizza function  and not applicable to other function.

INSTRUCTION FOR ROTISSERIE FORK

1. Clean the rotisserie handle and rotisserie forks with detergent and make them dry before using.
2. Screw out and remove the forks from the rotating bar.
3. Insert the chicken or another food in the rotating bar make sure it is stable. Then insert the forks to fix the food and screw down.
4. Adjust the position of the food to the middle of the rotating bar so that the food can be heated evenly.
5. Put the rotisserie forks on the supporter inside the oven, then set up the suitable time, function and temperature.
6. After the food is ready, wear gloves and take out the rotisserie forks by using the rotisserie handle and put the food on the baking tray.

Accessories	Foods (for reference only)	To use the tray handle
Baking tray 	1. Roast chicken wing 2. Hamburg steak 3. Gratin 4. Cake 5. Other oven-cooked foods	
Wire rack 	1. Baked potatoes 2. Dry food	
Baking tray and wire rack 	1. Broiled fish	

Note: Be careful when removing pudding or any others hot liquids from the oven after cooking.

1. There are 4 levels of rack support cater for different type of dishes you want to cook. You can adjust the cooking position by slotting the baking tray and wire rack at top, second, third or fourth rack support.

2. For example, when making macaroni gratin and you want to have the top part to be cooked the most, use the top or second rack support. For roasting a chicken, you can use the third or fourth rack support.

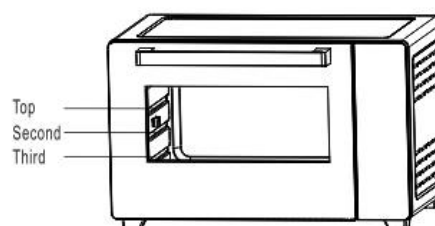

OPERATING THE APPLIANCE FOR THE FIRST TIME

1. Unpack the appliance and place it on a flat horizontal counter top. Check all the accessories whether all in good condition.

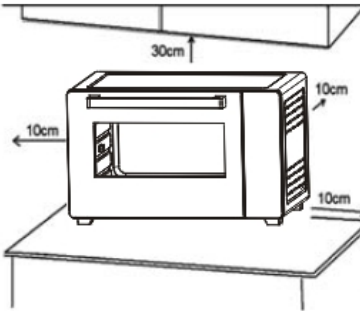

2. For correct operation, the oven must have sufficient airflow. Please follow the picture above for the correct position.
3. For initial use, please clean the accessories with detergent and water. Wipe the inner oven with dry cloth.
4. Re-assemble the accessories into the inner oven and insert the plug into the wall outlet for ready to use the electric oven.
5. It is recommended to select the temperature to max level 250°C for approximately 15 minutes to eliminate the oil that still remain in the inner oven. This will also remove all traces of glass door initially present.
Caution: The body and inner oven can be very hot after preheating.
6. Do not worry about the smoke as it is normal for the first time heating. The smoke will be disappear after about 20 minutes.
7. Insert foods that need to be preheat and adjust the temperature, timer and heating type that suits the food.

OPERATING THE APPLIANCE



1. In general, it is not necessary to preheat the oven but for better cooking result, complete step 5 (under operating the appliance for the first time) every time before storing food into the oven.

Caution: The body oven can be very hot after preheating.

2. Insert foods that need to be preheated and adjust the temperature, timer and heating knob that suit the foods.
3. Note: Temperature set at 100°C, the heating element will appear grey color (it is normal). When the temperature set at 200°C, the heating element will turn to red color.

Warning: Do not touch the heating element while operating the oven even it looks grey. At this stage, the heating elements have start to preheat and it might be very hot at the surface. Due to life cycle of the heating elements, after several usage, the heating element might not have the same color like the first time use. However, it is normal and the cooking result is still well.





OPERATION GUIDE

1. Power on the appliance and you will hear a “beeping” sound. The display screen will show “0:00” as default time. The oven is on standby mode but not operating.
2. Touch the “Timer”  key, the time will start flashing for hour adjustment, continue by touching “+” or “-” to adjust the time. The unit is 1 hour plus or minus for each press; Touch the “Timer” key again, the time will flashing for minute adjustment. The unit is 1 minute plus or minus for each press. When hold the “+” or “-” key for more than 2 seconds will automatically enter to fast forward mode or rewind mode speed to reach the desired time.
3. **8 Preset Programs:**
 - a. Touch any icon from the Menu, the corresponding function icon on the display screen will light up. The display screen will show the default timer and temperature.
 - b. The default timer for the first to three digits is represent of minutes, and the second two digits is represent of seconds.
 - c. After selected your desired function from the Menu, touch the “Start/Stop”  key, the oven will start to operate and the timer will begin to countdown.
 - d. If you did not touch the “Start/Stop” key to start operate, the oven will back to standby mode after 1 minute.
 - e. Touch the “Start/Stop” key when the oven is operating, the oven will pause and the background light of “Start/Stop” will be blinking. You can touch the “Start/Stop” key again to continue the program.
 - f. Press and hold the “Start/Stop” key for 3 seconds to cancel the program.

Program	Default Timer	Default Temp.	Timer Adjustment	Temp. Adjustment	Default Working Mode
 Pizza	30Min	150°C	YES	YES	Top & Bottom Heating, Convection, Rotisserie
 Smart Toast	Class 3	250°C	\	\	Top & Bottom Heating
 Cookies	20Min	170°C	YES	\	Top & Bottom Heating
 Cake	60Min	140°C	YES	YES	Top & Bottom Heating
 Grilling	45Min	250°C	YES	\	Top & Bottom Heating, Convection, Rotisserie
 Steak	20Min	200°C	YES	YES	Top & Bottom Heating, Convection
 Keep Warm	60Min	80°C	YES	\	Bottom Heating,
 Defrost	120Min	40°C	YES	\	Top Heating, Convection

- g. When you choose the Smart Toast  function, the display screen does not display the timer. It will show the default number "3", you can select the bread toast level by touching the "+" or "-" to have your desired color of bread baking degree. The higher of the level, the more toast on the bread.

4. Individual Heating Selection (DIY Mode)

- a. Touch the "FUNC." key to select the individual of heating selection  ; the default temperature display starting from 150°C, and the default timer countdown beginning from "30:00". Continue to touch the "Start/Sop" key, the oven will start to operate and the timer will begin to countdown.
- b. After select the heating selection from "FUNC." key, you have the option to select the convection function  key, and this function only workable together with the "FUNC." key.
- c. Touch the "Temp."  key for temperature adjustment from 40°C up to 250°C, and then continue by touching "+" or "-" to adjust the temperature. The unit is 5°C plus or minus for each press; when hold the "+" or "-" key for more than 2 seconds will automatically enter to fast forward mode or rewind mode speed to reach the desired temperature level. Continue to touch the "Temp." key for your temperature selection.
- d. Touch the "Timer"  key for timer adjustment from 1 minute up to 180 minutes, and then continue by touching "+" or "-" to adjust the timer. The unit is 1 minute plus or minus for each press; when hold the "+" or "-" key for more than 2 seconds will automatically enter to fast forward mode or rewind mode speed to reach the desired time. Continue to touch the "Start/Sop" key, the oven will start to operate and the timer will begin to countdown.
- e. During cooking cycle, you can touch the "Temp." key followed by touching "+" or "-" to adjust the temperature. After adjusted, touch the "Temp." key to confirm or the program will automatically confirm after 2 seconds.
- f. During cooking cycle, you can touch the "Timer" key followed by touching "+" or "-" to adjust the timer. After adjusted, touch the "Timer." key to confirm or the program will automatically confirm after 2 seconds.
- g. Touch the "Start/Stop" key when the oven is operating, the oven will pause and the background light of "Start/Stop" is blinking. You can touch the "Start/Stop" key again to continue the program.
- h. Press the "Start/Stop" key for 3 seconds to cancel the program.

5. Smart Care:

- a. Power on the appliance, touch the "Temp." key immediately and hold for more than 3 seconds, the program will automatically enter to the self-testing mode.
- b. The oven buzzer will ring for 2 seconds and display screen will back to clock state after finish self-testing.

- c. If notice of abnormal, the buzzer will continuous ring until the power is unplugged.
- d. In the process of operation, when the temperature sensor is short-circuit or open circuit, all function of the system will stop working immediately (except the inner lamp). The buzzer will ring for 3 times and the digital screen will only display "E1" or "E2" to alert the user.

Screen Display	Fault Detected
E1	Short circuit of temperature sensor
E2	Open circuit of temperature sensor

CLEANING AND MAINTENANCE

1. After use, power off the switch and unplug the plug from the wall outlet. Allow the appliance to cool down before cleaning.
2. Wipe the baking tray, wire rack and tray handle with absorbent paper or towel or soft cloth.
WARNING: Never immerse the appliance in water or any other liquids for cleaning.
3. Store the appliance in a safe clean place.

MAIN SPECIFICATIONS:

Model : EEO-J6091D(BK)
 Voltage : 220-240V 50/60Hz 2000W
 Capacity : 60 Litres

ENVIRONMENT-FRIENDLY DISPOSAL



You can help to protect the environment!
 Please remember to respect the local regulations: hand in the non-working electrical equipments to an appropriate waste disposal centre.



ELBA