

# ELBA

**DESIGNER HOOD**  
**MODEL: EH-J9088(SS)**

## **Owner's Manual**

Please read this manual carefully before operating your set.

Retain it for future reference.

Record model number and serial number of the set.

See the label attached on the set and quote this information to your dealer when you require service.

**For The Warranty Terms & Conditions, Please Refer To Warranty Certificate**

Please read this instruction carefully. It is advisable to keep this instruction manual in a safe place for future reference.

## **SAFETY PRECAUTIONS**

- 1.** Keep electrical appliances out of reach from children. Do not let them to operate the appliances without supervision.
- 2.** To protect against the risk of electrical shock, do not immerse the product, power cord or plug into water or any other liquid.
- 3.** This product is for household and indoor use only.
- 4.** This product is not intended for use by person (including children) with reduced physical, sensory or mental capabilities unless they have been given supervision or instruction concerning use of the appliance by a person responsible for their safety.
- 5.** If the power cord or plug is damaged, it must be replaced by the service centre or a qualified service technician to avoid hazard.
- 6.** Before installation, check if the mains supply voltage is matched with the voltage stated on the rating plate of the cooker hood.
- 7.** There must be adequate air ventilation of the room when the cooker hood is used with the cooking appliances with burning gas or other fuels.
- 8.** Ensure that the installation of exhaust complies with the standard of local building, gas and electrical authorities.
- 9.** Do not ignite flames in the pans.
- 10.** There is a risk of fire if cleaning is not carried out in accordance with this instruction.

# ASSEMBLY INSTRUCTIONS

Please check the following before installation:

- Installation of cooker hood must be carried out by an authorized or qualified technician.
- Remove all packaging materials from the cooker hood. Check and make sure that the cooker hood is not damaged.
- Please ensure the power supply has switched OFF when installing the cooker hood.
- For optimum air extraction, avoid having too many windows surrounding the cooker hood which will cause air convection.
- The optimum height for the installation is between 650 to 750mm which is measured from the bottom of the cooker hood to the top of the hob.
- Make sure the hood is in level after installation to avoid oil spill over from the oil cup.

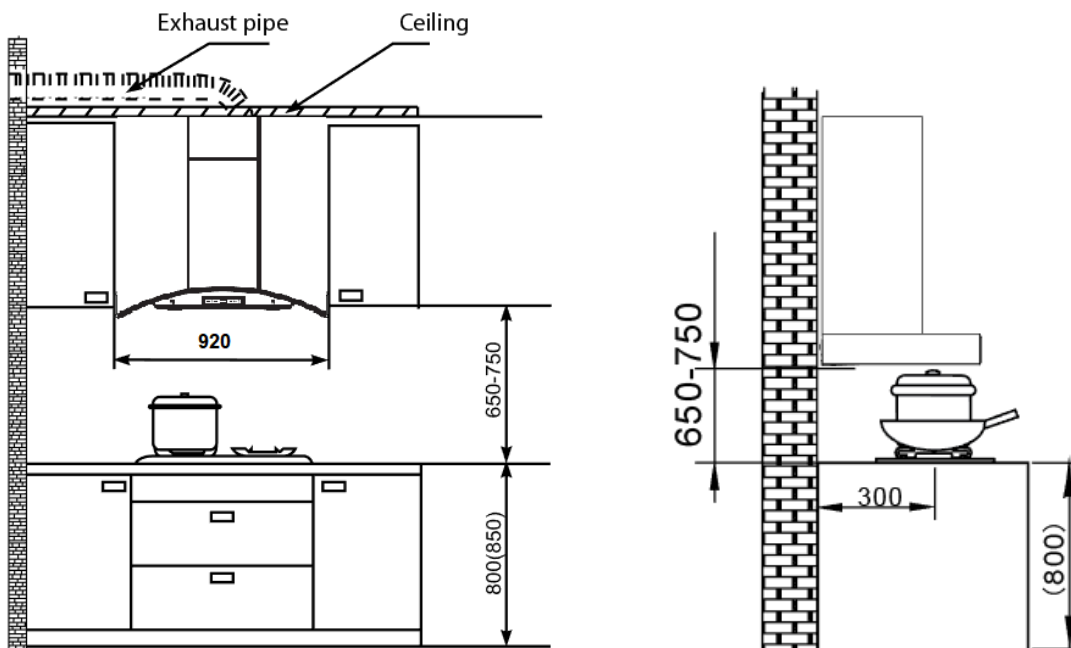

- Before installing, determine the height between the bottoms of the cooker hood to the top of the hob. Mark on the wall to suit the bracket locations.
- Drill 3 holes with diameter of  $\text{Ø}8\text{mm}$ . Insert the screw anchors into the holes. Fix the mounting bracket and tighten the screws.

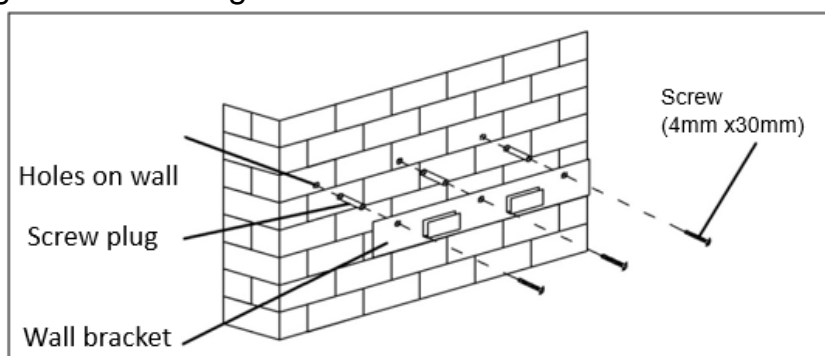

- Hang the cooker hood on the mounting bracket and make sure the cooker hood is in level.

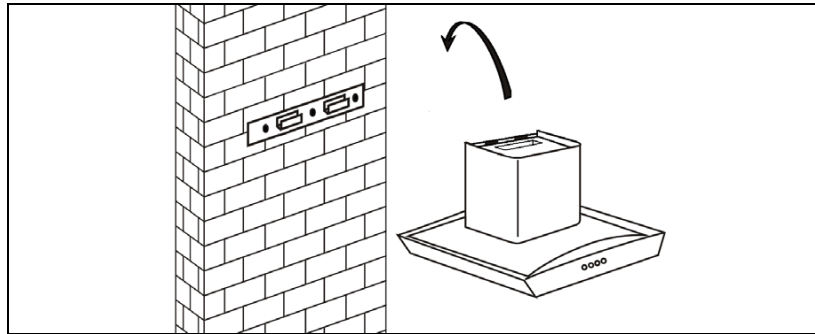

- Fix the exhaust ducting on the cooker hood. Install the oil cup on the cooker hood.

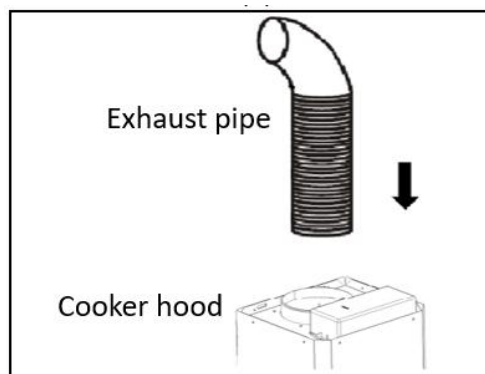

- Install the exhaust cover to the height required.

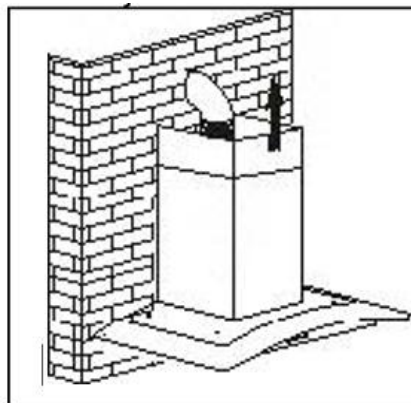

- Pull the upper exhaust cover upwards then install the fixing bracket to fix the exhaust cover position.

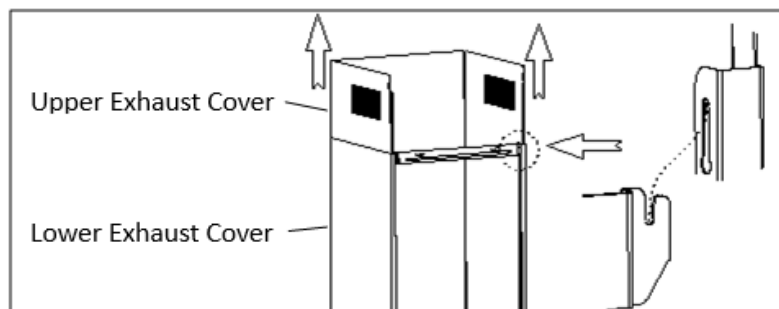

- Drill 2 holes with diameter of Ø8mm. Insert the screw anchors into the holes. Fix the mounting bracket and tighten the screws.

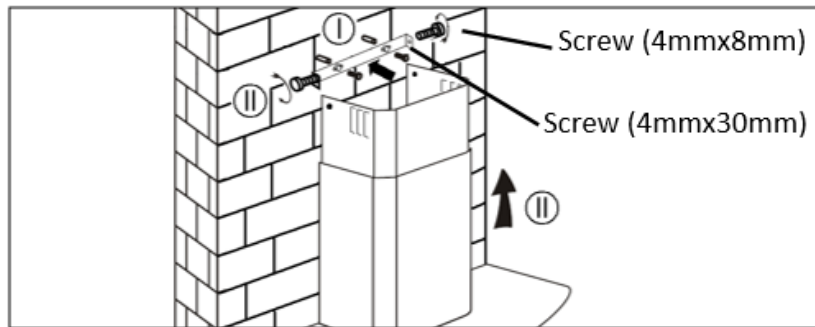

- Before connecting to the mains supply, ensure that the mains voltage corresponds to the voltage on the rating plate of the cooker hood.

## INSTALL THE CHARCOAL FILTER

- Disconnect the power supply and then remove the baffle filter.
- Install the charcoal filter and lock the position by turning anti-clockwise direction to tighten.
- To remove the charcoal filter, turn clockwise direction to loosen.
- There are two charcoal filters provided and install on the left and right position.

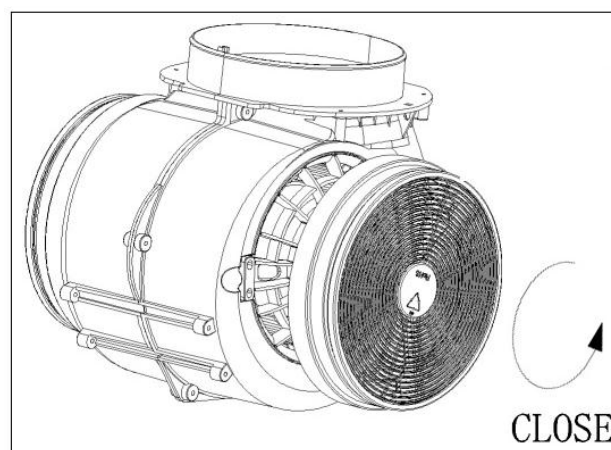



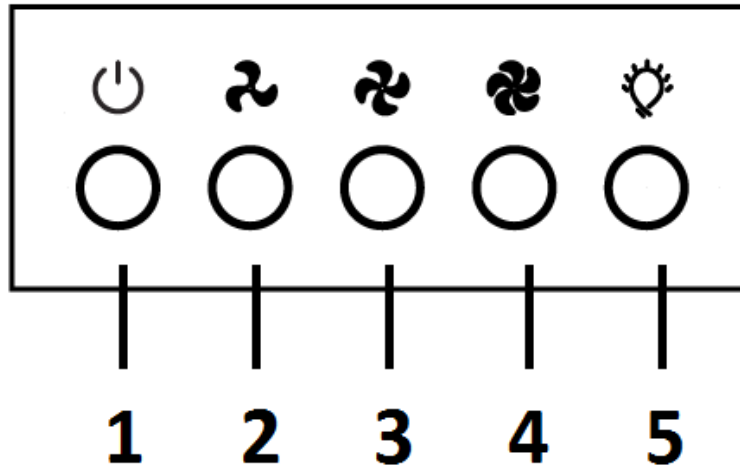



## PRODUCT DESCRIPTIONS



- 1 Off – Press to turn off the cooker hood.
- 2 Low Fan Speed Control – Press the button to set cooker hood in low fan speed.
- 3 Medium Fan Speed Control – Press the button to set cooker hood in medium fan speed.
- 4 High Fan Speed Control – Press the button to set cooker hood in high fan speed.
- 5 LED Light Illumination – Press to turn on the LED light. Press again to turn off the LED light.

## OPERATING INSTRUCTIONS

- 1 Press the  button to operate the cooker hood in low fan speed. Press the  button to operate the cooker hood at medium fan speed. Press the  button to operate the cooker hood at high fan speed. When the cooker hood is operating, press the  button to turn off the cooker hood.
- 2 Press the  button to turn on the LED light. Press  button again to turn off. (This function does not relate to the cooker hood motor)

## **CLEANING AND MAINTENANCE**

- The cooker hood must always be disconnected from the electricity supply before carrying out any maintenance.
- Clean the cooker hood with damp cloth, hot water and mild detergent. Do not use chemical, steel, wooden or abrasive cleaners to clean the cooker hood.
- Remove the oil cup in horizontal direction, wash in hot soapy water, dry and fit back into the cooker hood. Do not use the cooker hood without the oil cup installed.
- Avoid spilling water into the motor and electronic component.

### **CLEANING THE BAFFLE FILTER INNER OIL CUP**

- Disconnect the power supply and then gently push the clip on the baffle filter to eject and use both hands to remove it carefully.
- Remove the oil cup on the motor for cleaning.
- Clean the baffle filter with household cleaning detergent to ensure the filters are free from dirt (clean the filter once every month).
- After cleaning, install back the oil cup to its original position and put the baffle filter in place.

## TROUBLESHOOTING

<b>Malfunctions</b>	<b>Possible Root Cause</b>	<b>Checking</b>
Weak Suction	The distance is too far between the cooker hood and cooking appliance	Lower down the cooker hood installation height but within the safety guideline
	Strong convection due to too much ventilation	Shut off some of the windows or doors
Cooker hood and light not function	The power supply is not connected	Check if the plug is well connected and the power is on
	Power cord is damaged	Contact technicians for repair
Motor functions but light not works	Light bulb is damaged	Contact technicians to replace a new light bulb
Light works but motor not function	The bearing may be damaged	Contact technicians for repair
	The internal wires or motor capacitor may be burnout	
Vibration on the cooker hood	The screw is loosen	Tighten the screws
The cooker hood is noisy	Exhaust pipe surface is distorted	Contact technicians to reinstall the exhaust pipe



## MAIN SPECIFICATION

Rated Voltage	: 220-240V/50Hz
LED Light	: 2W x 2
Suction Power	: 1,400m <sup>3</sup> /hr
Motor Power	: 270W
Product Dimension	: 895mm (W) x 549-1,029mm (H) x 500mm (D)

## PRODUCT DIMENSION

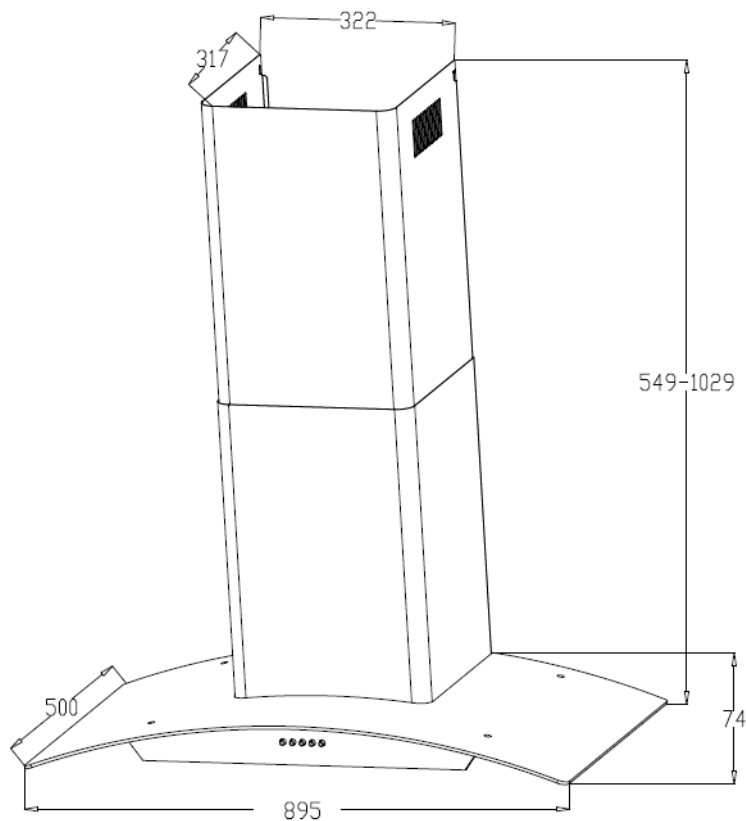

### NOTICE

This product must not be disposed together with domestic waste. It has to be disposed at an authorized place for recycling of electrical and electronic appliances. By collecting and recycling waste, you help to save natural resources and make sure the product is disposed in an environmental friendly and healthy way.



**ELBA**