

ELBA

DESIGNER HOOD
MODEL: EH-H9321ST(BK)

Owner's Manual

Please read this manual carefully before operating your set.

Retain it for future reference.

Record model number and serial number of the set.

See the label attached on the set and quote this information to your dealer when you require service.

For The Warranty Terms & Conditions, Please Refer To Warranty Certificate

Please read this instruction carefully. It is advisable to keep this instruction manual in a safe place for future reference.

SAFETY PRECAUTIONS

- 1.** Keep electrical appliances out of reach from children. Do not let them to operate the appliances without supervision.
- 2.** To protect against the risk of electrical shock, do not immerse the product, power cord or plug into water or any other liquid.
- 3.** This product is for household and indoor use only.
- 4.** This product is not intended for use by person (including children) with reduced physical, sensory or mental capabilities unless they have been given supervision or instruction concerning use of the appliance by a person responsible for their safety.
- 5.** If the power cord or plug is damaged, it must be replaced by the service centre or a qualified service technician to avoid hazard.
- 6.** Before installation, check if the mains supply voltage is matched with the voltage stated on the rating plate of the cooker hood.
- 7.** There must be adequate air ventilation of the room when the cooker hood is used with the cooking appliances with burning gas or other fuels.
- 8.** Ensure that the installation of exhaust complies with the standard of local building, gas and electrical authorities.
- 9.** Do not ignite flames in the pans.
- 10.** There is a risk of fire if cleaning is not carried out in accordance with this instruction.

ASSEMBLY INSTRUCTIONS

Please check the following before installation:

- Installation of cooker hood must be carried out by an authorized or qualified technician.
- Remove all packaging materials from the cooker hood. Check and make sure that the cooker hood is not damaged.
- Please ensure the power supply has switched OFF when installing the cooker hood.
- For optimum air extraction, avoid having too many windows surrounding the cooker hood which will cause air convection.
- The optimum height for the installation is between 250 to 270mm which is measured from the bottom of the cooker hood to the top of the hob.
- Make sure the hood is in level after installation to avoid oil spill over from the oil cup.

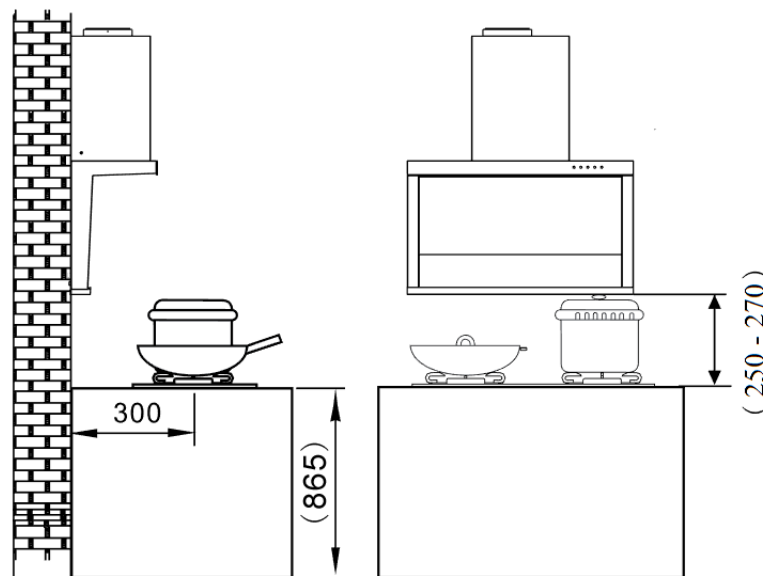

- Before installing, determine the height between the bottom of the cooker hood to the top of the hob. Mark on the wall to suit the bracket locations.

Dimension on exhaust hole (Top View)

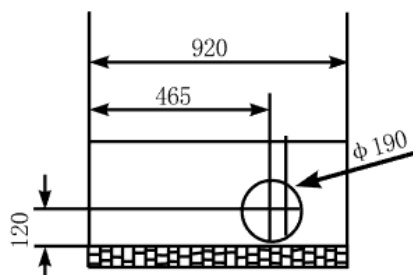

Installation on decorative cover (Top View)

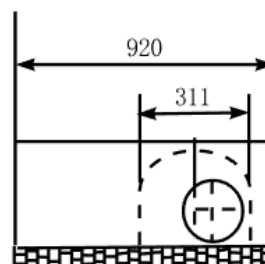

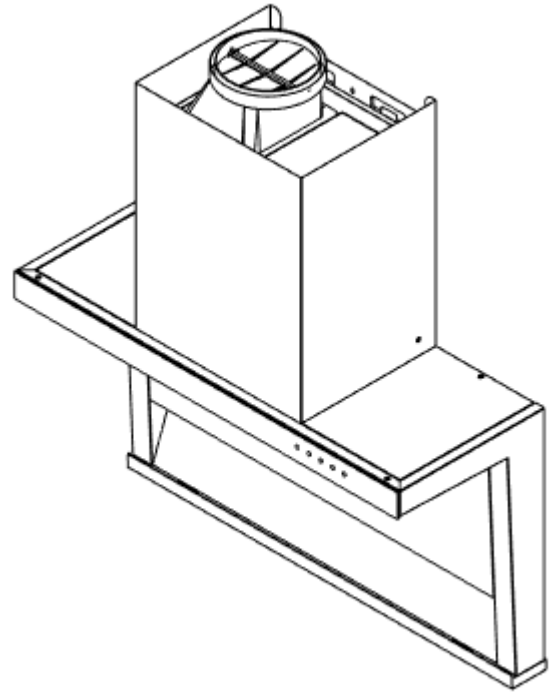
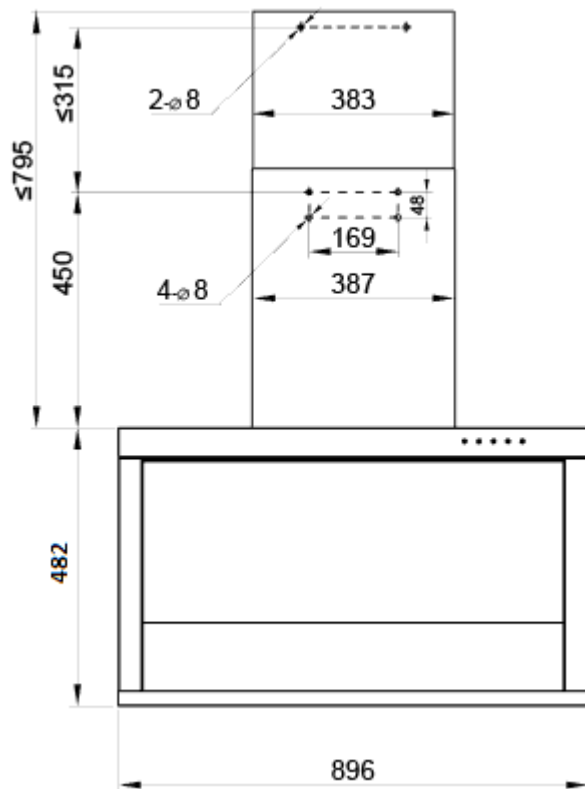





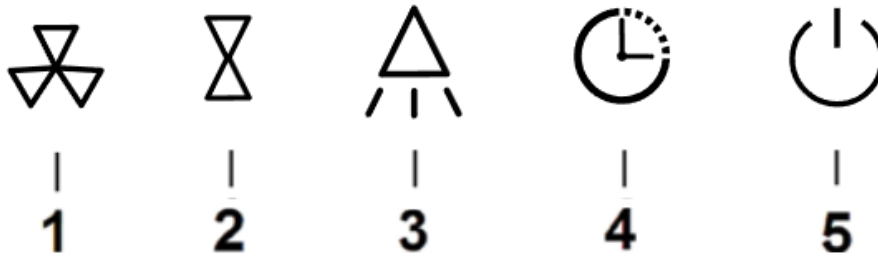

- Drill 4 holes with diameter of $\varnothing 8$ mm and 60mm deep. Insert the screw anchors into the holes. Fix the mounting bracket and tighten the screws.
- Remove the horizontal oil cup. Hang the cooker hood on the mounting bracket and make sure the cooker hood is in level.
- Fix the exhaust ducting on the cooker hood. Install the oil cup on the cooker hood.
- Install the telescopic exhaust cover to the height required.
- Before connecting to the mains supply, ensure that the mains voltage corresponds to the voltage on the rating plate of the cooker hood.

PRODUCT DESCRIPTIONS



- 1 High Fan Speed – To operate cooker hood in high fan speed.
- 2 Normal Fan Speed – To operate cooker hood in normal fan speed.
- 3 LED Light Illumination – To switch on/off the LED light.
- 4 Fan Delay Off Function – To schedule three minutes delay to turn off the cooker hood.
- 5 On/Off Button – To switch the cooker hood to standby mode and turn off the cooker hood.

OPERATING INSTRUCTIONS

- 1 Press the  button and press the  button to operate the cooker hood in normal fan speed. Press the  button to operate the cooker hood at high fan speed.
- 2 When the motor is running in normal or high fan speed, press  button to turn off the cooker hood. (This function does not relate to the LED light illumination)
- 3 When the motor is running in normal or high fan speed, press  button to schedule the cooker hood to turn off after three minutes. Cooker hood will be turn off after three minutes. Press  button again to deactivate this function.
- 4 Press the  button to turn on the LED lamp. Press again to turn off. (This function does not relate to the cooker hood motor)

CLEANING AND MAINTENANCE

- The cooker hood must always be disconnected from the electricity supply before carrying out the maintenance.
- Clean the cooker hood with damp cloth, hot water and mild detergent. Do not use chemical, steel, wooden or abrasive cleaners to clean the cooker hood.
- Remove the oil cup in horizontal direction, wash in hot soapy water, dry and fit back into the cooker hood. Do not use the cooker hood without the oil cup installed.
- Avoid spilling water into the motor and electronic component.

CLEANING THE INNER PART

- Disconnect the power supply and then pull the glass panel from the bottom with both hands from the left and right.

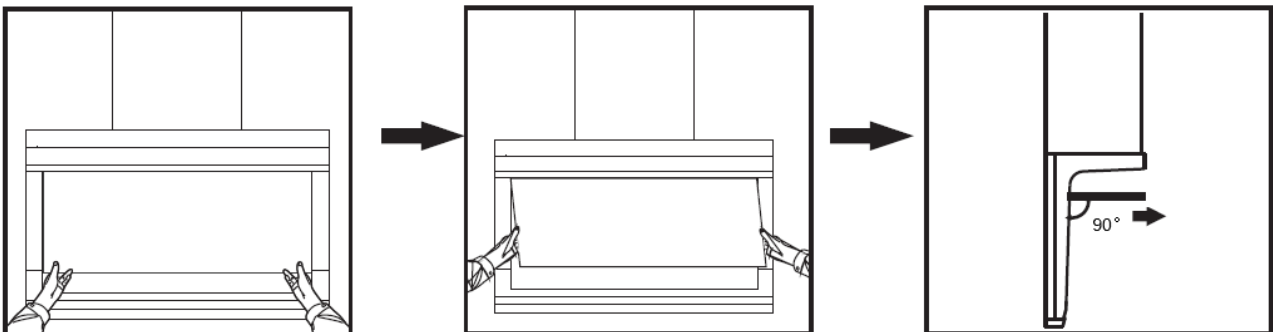

- Turn the glass panel upward and press the safety lock on the left side so that glass panel could turn until 90° to remove the glass panel completely.
- Remove the decorative cover and loosen the screws on the base.

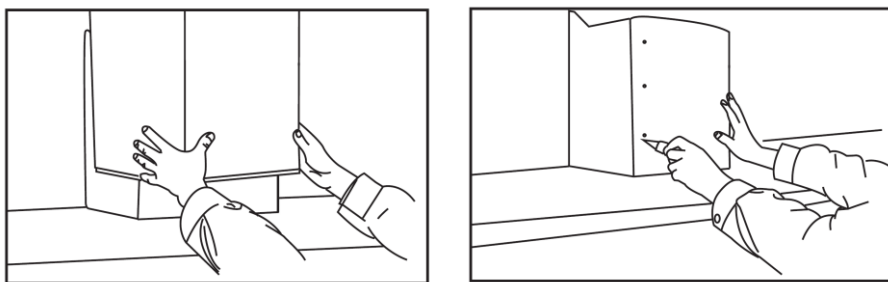

- Loosen the screws on the charcoal filter and then take it out.

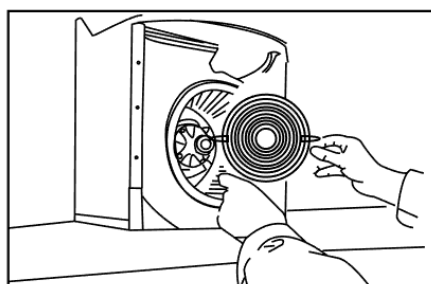

- Loosen the screws on the air inlet ring and then take out the filter.

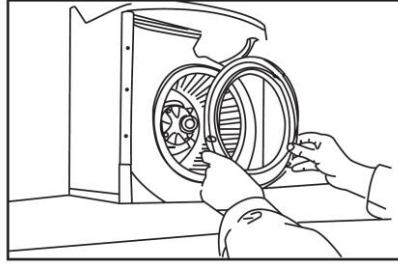

- Turn the locking nut in clockwise direction to take out the impeller for cleaning.

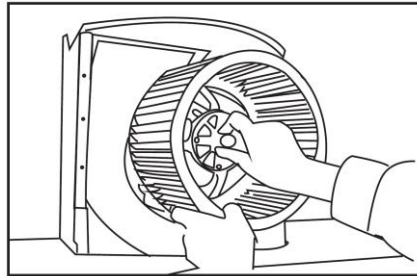

REPLACING THE LIGHT BULB

- Disconnect the power supply, slightly insert the screwdriver at the edge of the LED light and pry downward to take out the LED light (4W).
- Disconnect the connecting cable of LED light (4W) and replace a new LED light unit (4W). Connect the power supply to ensure LED light (4W) is functioning.

✘ The LED light bulb shall not be greater than 4W.

TROUBLESHOOTING

Malfunctions	Possible Root Cause	Checking
Weak Suction	The distance is too far between the cooker hood and cooking appliance	Lower down the cooker hood installation height but within the safety guideline
	Strong convection due to too much ventilation	Shut off some of the windows or doors
Cooker hood and light not function	The power supply is not connected	Check if the plug is well connected and the power is on
	Power cord is damaged	Contact technicians for repair
Motor functions but light not works	Light bulb is damaged	Replace a new light bulb ($\leq 4W$)
Light works but motor not function	The bearing may be damaged	Contact technicians for repair
	The internal wires or motor capacitor may be burnout	
Vibration on the cooker hood	The screw is loosen	Tighten the screws
The cooker hood is noisy	Exhaust pipe surface is distorted	Contact technicians to reinstall the exhaust pipe

MAIN SPECIFICATION

Rated Voltage	: 220-240V/50Hz
LED Light	: 4W x 1
Suction Power	: 1,400m ³ /hr
Motor Power	: 220W
Product Dimension	: 896mm (W) x 976 - 1,277mm (H) x 350mm (D)

PRODUCT SIZE

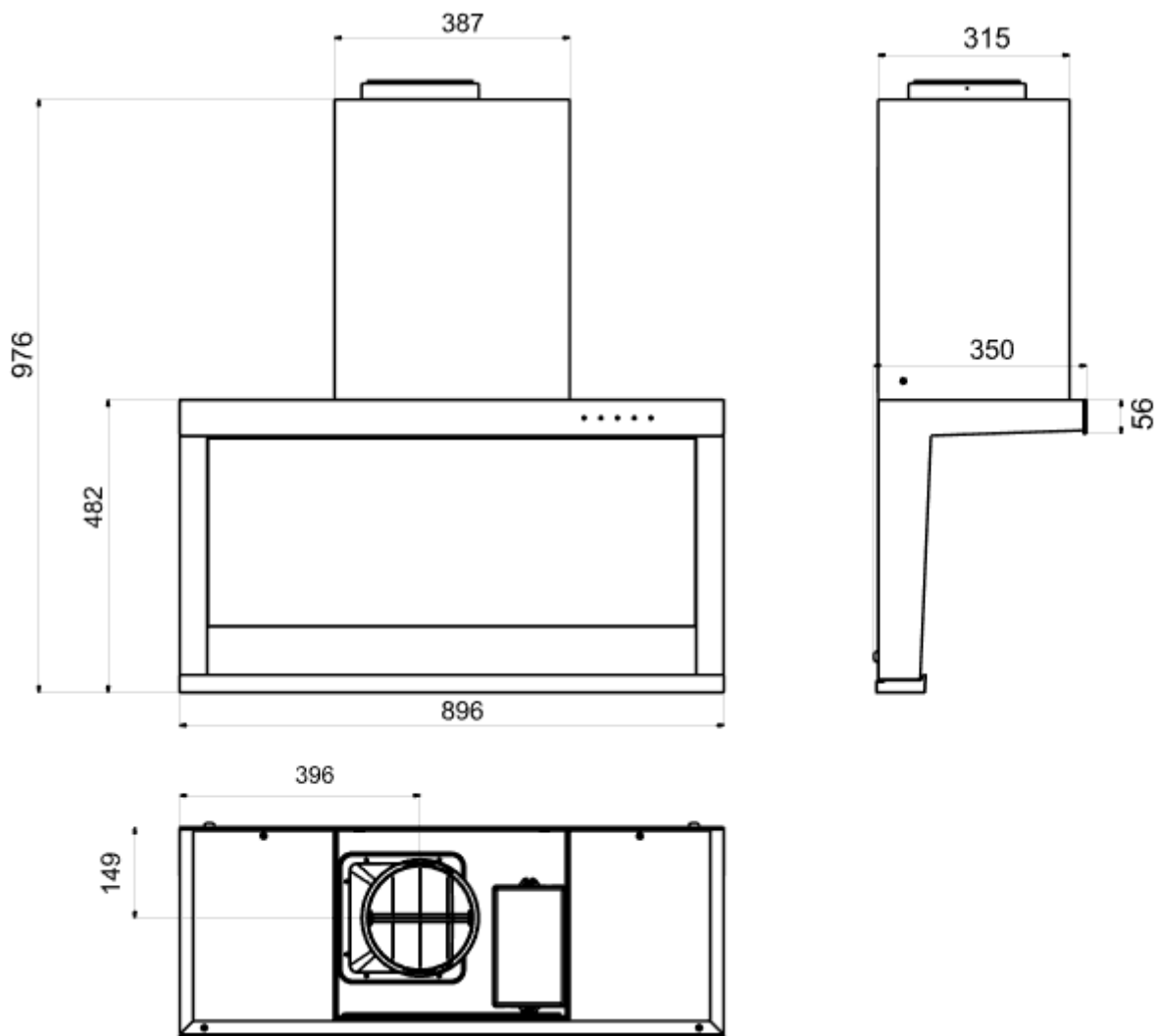

NOTICE

This product must not be disposed together with domestic waste. It has to be disposed at an authorized place for recycling of electrical and electronic appliances. By collecting and recycling waste, you help to save natural resources and make sure the product is disposed in an environmental friendly and healthy way.



ELBA