

ELBA
Looks Good. Works Even Better.

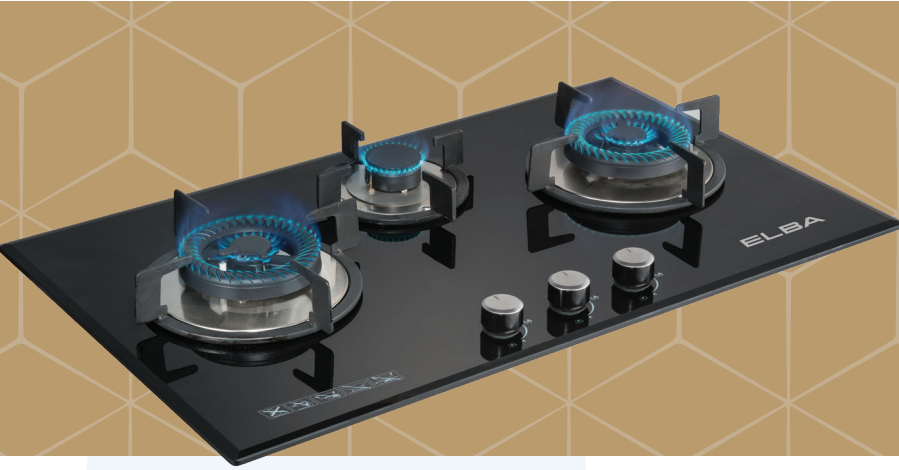

PREMIUM TOUCH TO YOUR KITCHEN

COOKER HOOD & GLASS STOVE
SERIES 2023



GLASS STOVE

ELBA Glass Stoves provide a premium touch to your kitchen while making your cooking experience a breeze. The usage of premium tempered glass gives it a smooth surface that is stylish and easy to clean while being sturdy and durable to overtime usage.

EGH-N8822G(BK) NEW



Product Dimension(mm): 760(W) x 460(D)
Built-in Dimension (mm): 703(W) x 403(D)

- 2 x Triple Ring Burners (5.0kW)
- Ø110 x 110mm Brass Burner Rings and Caps
- High Quality Tempered Glass
- Automatic Battery Ignition
- Windproof Cover
- Cast Iron Pan Support
- Cast Iron Wok Stand

EGH-K8842G(BK)

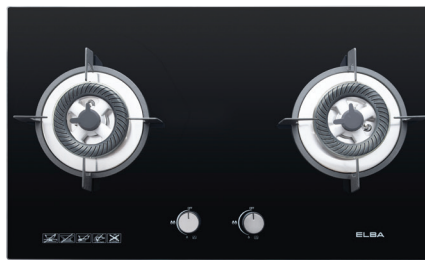

Product Dimension(mm): 760(W) x 460(D)
Built-in Dimension (mm): 703(W) x 403(D)

- 2 x Triple Ring Burners (5.0kW)
- Ø128 x 128mm Brass Burner Rings and Caps
- Aluminium Burner Base
- High Quality Tempered Glass
- Automatic Battery Ignition
- Cast Iron Pan Support
- Cast Iron Wok Support

EGH-K8843G(BK)

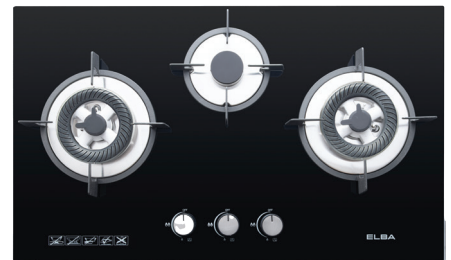

Product Dimension(mm): 760(W) x 460(D)
Built-in Dimension (mm): 703(W) x 403(D)

- 2 x Triple Ring Burners (5.0kW)
- + 1 x Auxiliary Ring Burner (1.8kW)
- Ø128 x 128mm Brass Burner Rings and Caps
- Aluminium Burner Base
- High Quality Tempered Glass
- Automatic Battery Ignition
- Cast Iron Pan Support
- Cast Iron Wok Stand



EGH-M8442G(BK) NEW



Product Dimension(mm): 760(W) x 440(D)
Built-in Dimension (mm): (650-720)(W) x (350-410)(D)

- 2 x Triple Ring Burners (4.8kW)
- Ø120 x 120mm Brass Burner Rings and Caps
- Flexi-Base Design
- High Quality Tempered Glass
- Automatic Battery Ignition
- Matt Black Enamel Pan Support
- Enamel wok stand

EGH-J8552G(BK)



Product Dimension(mm): 760(W) x 440(D)
Built-in Dimension (mm): (650-720)(W) x (350-410)(D)

- 2 x Turbo Jet Burners (5.0kW)
- Ø120 x 120mm Brass Burner Rings and Caps
- Flexi-Base Design
- High Quality Tempered Glass
- Automatic Battery Ignition
- Cast Iron Pan Support
- Enamel Wok Stand

FLEXI-BASE

The Flexi-Base is a unique, flexible base design that allows you to modify your counter-top's cut-out size as needed. It's also the best ideal model to fit all the sizes as replacement hob. Whether it's an existing stand alone gas cooktop or a new kitchen set up, your Flexi-Base will fit seamlessly into your décor.

Common Points

- Easy-cleaning Glass Top
- Front Control Panel for Easy Operation
- Easy-cleaning Stainless Steel Gravy Tray
- Built-in or Countertop Dual Usage
- 4 Rubber Stands for Freestanding

INFINITO EH-J9088(SS)

Product Dimension(mm): 895(W) x 549 - 1,029(H) x 500(D)

- Suction Power (m³/hr): 1,400
- With 3-speeds Fan Control
- With Charcoal Filter
- Washable Pyramidal Shaped Filter with Oil Cup
- Premium Stainless Steel Chassis



Recirculating System



Slim Hoods

ESH-M7598(BK) **NEW**



Product Dimension(mm): 750(W) x 490(D) x 100(H)

- Suction Power (m³/hr): 900
- Speed Range (rpm): 1,140
- Twin Motors
- Venting Type: Updraft
- 2 x Metal Grease Filter
- 3-Speeds Fan Control
- 2 x Charcoal Filter
- With Glass Visor

ESH-M9098(BK) **NEW**



Product Dimension(mm): 900(W) x 490(D) x 100(H)

- Suction Power (m³/hr): 900
- Speed Range (rpm): 1,140
- Twin Motors
- Venting Type: Updraft
- 3 x Metal Grease Filter
- 3-Speeds Fan Control
- 2 x Charcoal Filter
- With Glass Visor

1917/76 (SS)

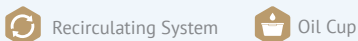

Product Dimension(mm): 755(W) x 510(D) x 100(H)

- Suction Power (m³/hr): 900
- Speed Range (rpm): 1,100
- Twin Motors & Twin Blowers
- Venting Type: Updraft
- Detachable Oil Cups for Easy Cleaning

ESH-J7695(SS)

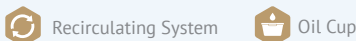

Product Dimension(mm): 750(W) x 510(D) x 120(H)

- Suction Power (m³/hr): 900
- Speed Range (rpm): 1,100
- Twin Motors & Twin Blowers
- Venting Type: Updraft
- Detachable Oil Cups for Easy Cleaning

COOKER HOOD



NO. 1 COOKER HOODS BRAND IN MALAYSIA*



EFFICIENT VENTILATION SYSTEM



HIGH PERFORMANCE FILTRATION SYSTEM



BUILT-IN OIL CUP TO COLLECT GREASE AND OIL FOR EASY-CLEANING



* Source Euromonitor International Limited; Consumer Appliances 2023ed. Retail Volume Sales, 2020-2022 data

Common Points

- LED Light
- Convenient Ductless Range Hood
- Push Button Function Key
- Slim & Sleek Design to Compliment Any Kitchen Size

PRODUCT DIMENSION

GLASS STOVES

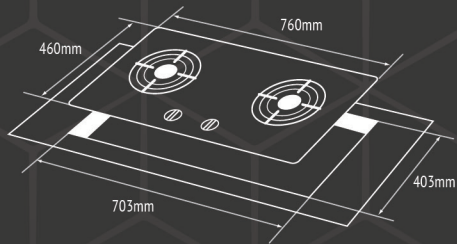

EGH-N8822G(BK)

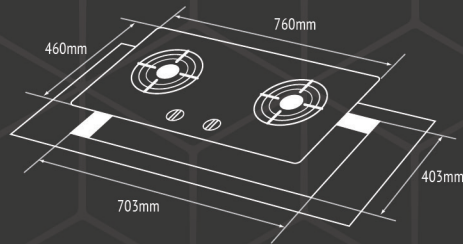

EGH-K8842G(BK)

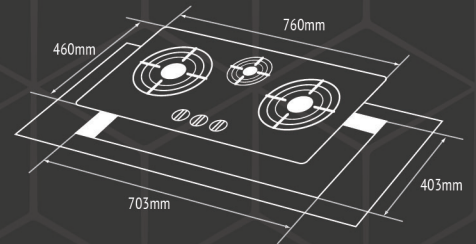

EGH-K8843G(BK)

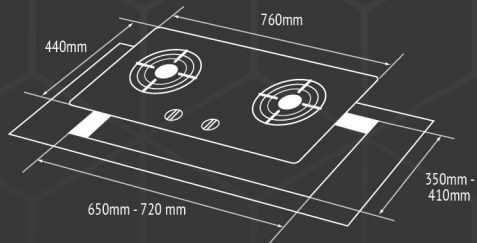

EGH-M8442G(BK)

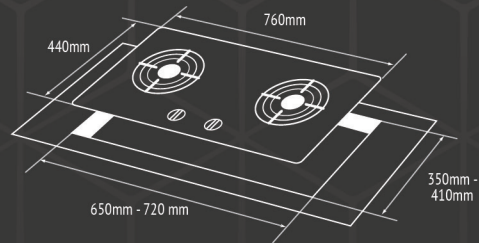

EGH-J8552G(BK)

COOKER HOOD

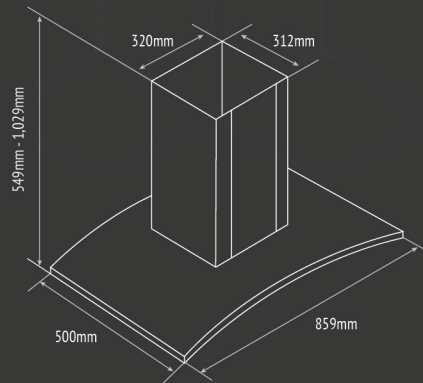

INFINITO EH-J9088(SS)

SLIM HOODS

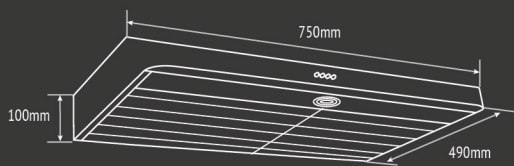

ESH-M7598(BK)

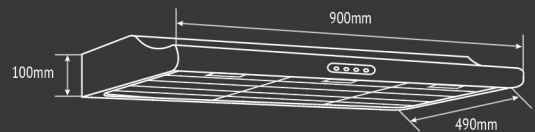

ESH-M9098(BK)

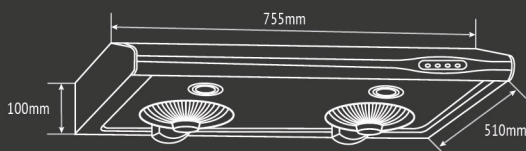

1917/76 (SS)

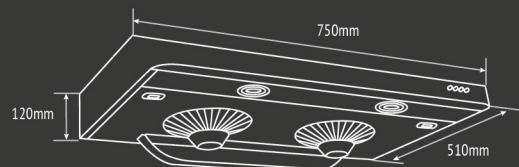

ESH-J7695(SS)

*Product images are for illustration purposes only.
Actual colours and specifications may vary from images shown in this catalogue.



FIAMMA SDN. BHD. (47268-M)
Wisma Fiamma, No.20, Jalan 7A/62A,
Bandar Manjalara, 52200 Kuala Lumpur

Tel: 03-6279 8888
Fax: 03-6279 8846

www.elba.com.my

ELBAMalaysia

